



ROYAL CANADIAN ARMY CADETS

GREEN STAR – INSTRUCTIONAL GUIDES

(ENGLISH)

(Supersedes A-CR-CCP-701/PF-001 dated 2015-09-01)

Cette publication est disponible en français sous le numéro A-CR-CCP-701/PF-002.

Issued on Authority of the Chief of the Defence Staff

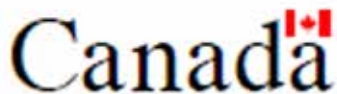



NOTICE

This documentation has been reviewed by the technical authority and does not contain controlled goods. Disclosure notices and handling instructions originally received with the document shall continue to apply.

AVIS

Cette documentation a été révisée par l'autorité technique et ne contient pas de marchandises contrôlées. Les avis de divulgation et les instructions de manutention reçues originellement doivent continuer de s'appliquer.

ROYAL CANADIAN ARMY CADETS

GREEN STAR – INSTRUCTIONAL GUIDES

(ENGLISH)

(Supersedes A-CR-CCP-701/PF-001 dated 2015-09-01)

Cette publication est disponible en français sous le numéro A-CR-CCP-701/PF-002.

Issued on Authority of the Chief of the Defence Staff

LIST OF EFFECTIVE PAGES

Insert latest changed pages; dispose of superseded pages in accordance with applicable orders.

NOTE

On a changed page, the portion of the text affected by the latest change is indicated by a vertical line in the margin of the page. Changes to illustrations by miniature pointing hands, or black vertical lines.

Dates of issue for original and changed pages are:

Original	0	2016-08-31	Change	3
Change	1		Change	4
Change	2		Change	5

Zero in Change No. column indicates an original page. Total number of pages in this publication is 1428, consisting of the following:

Page No.	Change No.	Page No.	Change No.
Cover page	0	1-MX01.01HB-1 to 1-MX01.01HB-2.....	0
Title	0	1-MX01.01HB1-1 to 1-MX01.01HB1-2.....	0
A to C	0	1-MX01.01HB2-1 to 1-MX01.01HB2-8.....	0
i to xx	0	1-MX01.01HC-1 to 1-MX01.01HC-2.....	0
1-X01-1/2	0	1-MX01.01HC1-1 to 1-MX01.01HC1-14.....	0
1-MX01.01A-1 to 1-MX01.01A-2.....	0	1-MX01.01HC2-1 to 1-MX01.01HC2-2.....	0
1-MX01.01B-1 to 1-MX01.01B-2.....	0	1-MX01.01HD-1 to 1-MX01.01HD-2.....	0
1-MX01.01C-1 to 1-MX01.01C-2.....	0	1-MX01.01HD1-1 to 1-MX01.01HD1-2.....	0
1-MX01.01D-1 to 1-MX01.01D-2.....	0	1-MX01.01HD2-1 to 1-MX01.01HD2-2.....	0
1-MX01.01E-1 to 1-MX01.01E-2.....	0	1-MX01.01HD3-1 to 1-MX01.01HD3-4.....	0
1-MX01.01F-1 to 1-MX01.01F-4.....	0	1-MX01.01HE-1 to 1-MX01.01HE-2.....	0
1-MX01.01FA-1 to 1-MX01.01FA-4.....	0	1-MX01.01HE1-1 to 1-MX01.01HE1-2.....	0
1-MX01.01FB-1 to 1-MX01.01FB-4.....	0	1-MX01.01HE2-1 to 1-MX01.01HE2-2.....	0
1-MX01.01FC-1 to 1-MX01.01FC-6.....	0	1-MX01.01HF-1 to 1-MX01.01HF-2.....	0
1-MX01.01FD-1 to 1-MX01.01FD-4.....	0	1-MX01.01HF1-1 to 1-MX01.01HF1-2.....	0
1-MX01.01G-1 to 1-MX01.01G-2.....	0	1-MX01.01HG-1 to 1-MX01.01HG-2.....	0
1-MX01.01GA-1 to 1-MX01.01GA-2.....	0	1-MX01.01HG1-1 to 1-MX01.01HG1-4.....	0
1-MX01.01GB-1 to 1-MX01.01GB-2.....	0	1-MX01.01HH-1 to 1-MX01.01HH-2.....	0
1-MX01.01GB1-1 to 1-MX01.01GB1-2.....	0	1-MX01.01HH1-1 to 1-MX01.01HH1-2.....	0
1-MX01.01GC-1 to 1-MX01.01GC-2.....	0	1-MX01.01HH2-1 to 1-MX01.01HH2-2.....	0
1-MX01.01GC1-1 to 1-MX01.01GC1-2.....	0	1-MX01.01HH3-1 to 1-MX01.01HH3-2.....	0
1-MX01.01GD-1 to 1-MX01.01GD-2.....	0	1-MX01.01HI-1 to 1-MX01.01HI-2.....	0
1-MX01.01GE-1 to 1-MX01.01GE-2.....	0	1-MX01.01HI1-1 to 1-MX01.01HI1-2.....	0
1-MX01.01GE1-1 to 1-MX01.01GE1-8.....	0	1-MX01.01HI2-1 to 1-MX01.01HI2-2.....	0
1-MX01.01GF-1 to 1-MX01.01GF-2.....	0	1-MX01.01HI3-1 to 1-MX01.01HI3-2.....	0
1-MX01.01GF1-1 to 1-MX01.01GF1-2.....	0	1-MX01.01HI4-1 to 1-MX01.01HI4-12.....	0
1-MX01.01GG-1 to 1-MX01.01GG-2.....	0	1-MX01.01HI5-1 to 1-MX01.01HI5-2.....	0
1-MX01.01GG1-1 to 1-MX01.01GG1-2.....	0	1-MX01.01HI6-1 to 1-MX01.01HI6-2.....	0
1-MX01.01H-1 to 1-MX01.01H-4.....	0	1-MX01.01HJ-1 to 1-MX01.01HJ-2.....	0
1-MX01.01HA-1 to 1-MX01.01HA-2.....	0	1-MX01.01HJ1-1 to 1-MX01.01HJ1-2.....	0
1-MX01.01HA1-1 to 1-MX01.01HA1-2.....	0	1-MX01.01HJ2-1 to 1-MX01.01HJ2-4.....	0
1-MX01.01HA2-1 to 1-MX01.01HA2-2.....	0	1-MX01.01HJ3-1 to 1-MX01.01HJ3-2.....	0
1-MX01.01HA3-1 to 1-MX01.01HA3-2.....	0	1-MX01.01HJ4-1 to 1-MX01.01HJ4-2.....	0

LIST OF EFFECTIVE PAGES (CONT)

Page No.	Change No.	Page No.	Change No.
1-MX01.01HK-1 to 1-MX01.01HK-2	0	4-MX04.01E-1 to 4-MX04.01E-2	0
1-MX01.01HK1-1 to 1-MX01.01HK1-2	0	4-MX04.01E1-1 to 4-MX04.01E1-2	0
1-MX01.01HK2-1 to 1-MX01.01HK2-2	0	4-MX04.01E2-1 to 4-MX04.01E2-6	0
1-MX01.01HK3-1 to 1-MX01.01HK3-2	0	4-MX04.01E3-1 to 4-MX04.01E3-6	0
1-MX01.01HL-1 to 1-MX01.01HL-2	0	4-MX04.01F-1 to 4-MX04.01F-2	0
1-MX01.01HL1-1 to 1-MX01.01HL1-2	0	4-MX04.01F1-1 to 4-MX04.01F1-4	0
1-MX01.01HL2-1 to 1-MX01.01HL2-2	0	4-MX04.01G-1 to 4-MX04.01G-4	0
1-MX01.01HL3-1 to 1-MX01.01HL3-6	0	4-MX04.01G1-1 to 4-MX04.01G1-2	0
1-MX01.01HL4-1 to 1-MX01.01HL4-6	0	4-MX04.01H-1 to 4-MX04.01H-2	0
1-MX01.01HL5-1 to 1-MX01.01HL5-2	0	4-MX04.02-1 to 4-MX04.02-8	0
1-MX01.01HM-1 to 1-MX01.01HM-2	0	4-MX04.02A-1 to 4-MX04.02A-2	0
1-MX01.01HM1-1 to 1-MX01.01HM1-2	0	4-MX04.02A1-1 to 4-MX04.02A1-2	0
1-MX01.01HM2-1 to 1-MX01.01HM2-4	0	4-MX04.03-1 to 4-MX04.03-6	0
1-MX01.01HM3-1 to 1-MX01.01HM3-4	0	4-MX04.03A-1 to 4-MX04.03A-2	0
1-MX01.01HM4-1 to 1-MX01.01HM4-2	0	4-MX04.03B-1 to 4-MX04.03B-2	0
1-CX01.01-1 to 1-CX01.01-2	0	4-CX04.01-1 to 4-CX04.01-2	0
2-X02-1/2	0	4-CX04.02-1 to 4-CX04.02-2	0
2-MX02.01-1 to 2-MX02.01-4	0	4-CX04.02A-1 to 4-CX04.02A-4	0
2-MX02.01A-1 to 2-MX02.01A-4	0	4-CX04.02B-1 to 4-CX04.02B-6	0
2-MX02.01B-1 to 2-MX02.01B-2	0	4-CX04.02C-1 to 4-CX04.02C-4	0
2-MX02.01C-1 to 2-MX02.01C-2	0	4-CX04.03-1 to 4-CX04.03-2	0
2-MX02.01D-1 to 2-MX02.01D-2	0	4-CX04.04-1 to 4-CX04.04-2	0
2-MX02.01E-1 to 2-MX02.01E-2	0	4-CX04.05-1 to 4-CX04.05-2	0
2-MX02.01F-1 to 2-MX02.01F-2	0	5-X05-1/2	0
2-CX02.01-1 to 2-CX02.01-2	0	5-MX05.01-1 to 5-MX05.01-8	0
3-103-1/2	0	5-MX05.01A-1 to 5-MX05.01A-2	0
3-M103.01-1 to 3-M103.01-6	0	5-MX05.01B-1 to 5-MX05.01B-6	0
3-M103.01A-1 to 3-M103.01A-2	0	5-MX05.01C-1 to 5-MX05.01C-4	0
3-M103.02-1 to 3-M103.02-6	0	5-MX05.01D-1 to 5-MX05.01D-2	0
3-M103.02A-1 to 3-M103.02A-2	0	5-MX05.01E-1 to 5-MX05.01E-2	0
3-M103.03-1 to 3-M103.03-8	0	5-MX05.01F-1 to 5-MX05.01F-8	0
3-M103.03A-1 to 3-M103.03A-2	0	5-MX05.01G-1 to 5-MX05.01G-2	0
3-C103.01-1 to 3-C103.01-6	0	5-MX05.01H-1 to 5-MX05.01H-2	0
3-C103.02-1 to 3-C103.02-4	0	5-MX05.01I-1 to 5-MX05.01I-2	0
3-C103.03-1 to 3-C103.03-6	0	5-MX05.01J-1 to 5-MX05.01J-4	0
3-C103.03A-1 to 3-C103.03A-2	0	5-MX05.01K-1 to 5-MX05.01K-2	0
4-X04-1/2	0	5-MX05.01L-1 to 5-MX05.01L-12	0
4-MX04.01-1 to 4-MX04.01-6	0	5-MX05.01M-1 to 5-MX05.01M-2	0
4-MX04.01A-1 to 4-MX04.01A-2	0	5-MX05.01N-1 to 5-MX05.01N-2	0
4-MX04.01A1-1 to 4-MX04.01A1-4	0	5-MX05.01O-1 to 5-MX05.01O-2	0
4-MX04.01B-1 to 4-MX04.01B-2	0	5-MX05.01P-1 to 5-MX05.01P-2	0
4-MX04.01B1-1 to 4-MX04.01B1-6	0	5-MX05.01Q-1 to 5-MX05.01Q-4	0
4-MX04.01C-1 to 4-MX04.01C-4	0	5-MX05.01R-1 to 5-MX05.01R-6	0
4-MX04.01C1-1 to 4-MX04.01C1-30	0	5-MX05.01S-1 to 5-MX05.01S-4	0
4-MX04.01C2-1 to 4-MX04.01C2-4	0	5-MX05.01T-1 to 5-MX05.01T-4	0
4-MX04.01C3-1 to 4-MX04.01C3-2	0	5-MX05.01U-1 to 5-MX05.01U-4	0
4-MX04.01D-1 to 4-MX04.01D-2	0	5-MX05.01V-1 to 5-MX05.01V-4	0
4-MX04.01D1-1 to 4-MX04.01D1-2	0	5-MX05.01W-1 to 5-MX05.01W-4	0
4-MX04.01D2-1 to 4-MX04.01D2-2	0	5-MX05.01X-1 to 5-MX05.01X-4	0
4-MX04.01D3-1 to 4-MX04.01D3-2	0	5-MX05.01Y-1 to 5-MX05.01Y-4	0

LIST OF EFFECTIVE PAGES (CONT)

Page No.	Change No.	Page No.	Change No.
5-MX05.01Z-1 to 5-MX05.01Z-4	0	7-C107.02A-1 to 7-C107.02A-2	0
5-MX05.01AA-1 to 5-MX05.01AA-4	0	7-C107.02B-1 to 7-C107.02B-2	0
5-MX05.01AB-1 to 5-MX05.01AB-2	0	7-C107.03-1 to 7-C107.03-6	0
5-MX05.01AC-1 to 5-MX05.01AC-2	0	7-C107.03A-1 to 7-C107.03A-2	0
5-MX05.01AD-1 to 5-MX05.01AD-2	0	7-C107.04-1 to 7-C107.04-4	0
5-MX05.01AE-1 to 5-MX05.01AE-4	0	7-C107.04A-1 to 7-C107.04A-6	0
5-CX05.01-1 to 5-CX05.01-2	0	8-108-1/2	0
5-CX05.02-1 to 5-CX05.02-6	0	8-M108.01-1 to 8-M108.01-10	0
5-CX05.02A-1 to 5-CX05.02A-2	0	8-M108.02-1 to 8-M108.02-8	0
5-CX05.02B-1 to 5-CX05.02B-2	0	8-M108.03-1 to 8-M108.03-8	0
5-CX05.02C-1 to 5-CX05.02C-2	0	8-M108.04-1 to 8-M108.04-6	0
5-CX05.02D-1 to 5-CX05.02D-4	0	8-M108.05-1 to 8-M108.05-6	0
5-CX05.02E-1 to 5-CX05.02E-2	0	8-M108.06-1 to 8-M108.06-8	0
6-106-1/2	0	8-M108.07-1 to 8-M108.07-6	0
6-M106.01-1 to 6-M106.01-6	0	8-M108.08-1 to 8-M108.08-8	0
6-M106.01A-1 to 6-M106.01A-2	0	8-M108.09-1 to 8-M108.09-6	0
6-M106.02-1 to 6-M106.02-8	0	8-M108.10-1 to 8-M108.10-6	0
6-M106.03-1 to 6-M106.03-10	0	8-M108.11-1 to 8-M108.11-6	0
6-M106.04-1 to 6-M106.04-6	0	8-M108.12-1 to 8-M108.12-2	0
6-M106.04A-1 to 6-M106.04A-2	0	8-C108.01-1 to 8-C108.01-2	0
6-M106.05-1 to 6-M106.05-6	0	8-C108.02-1 to 8-C108.02-4	0
6-C106.01-1 to 6-C106.01-4	0	8-C108.02A-1 to 8-C108.02A-2	0
6-C106.01A-1 to 6-C106.01A-2	0	8-C108.02B-1 to 8-C108.02B-2	0
6-C106.01B-1 to 6-C106.01B-2	0	8-C108.02C-1 to 8-C108.02C-2	0
6-C106.01C-1 to 6-C106.01C-4	0	8-C108.02D-1 to 8-C108.02D-2	0
6-C106.01D-1 to 6-C106.01D-2	0	9-111-1/2	0
6-C106.01E-1 to 6-C106.01E-2	0	9-C111.01-1 to 9-C111.01-8	0
6-C106.01F-1 to 6-C106.01F-4	0	9-C111.02-1 to 9-C111.02-10	0
6-C106.01G-1 to 6-C106.01G-2	0	9-C111.02A-1 to 9-C111.02A-8	0
6-C106.01H-1 to 6-C106.01H-2	0	9-C111.03-1 to 9-C111.03-10	0
6-C106.01I-1 to 6-C106.01I-2	0	9-C111.04-1 to 9-C111.04-12	0
6-C106.01J-1 to 6-C106.01J-2	0	9-C111.04A-1 to 9-C111.04A-4	0
6-C106.01K-1 to 6-C106.01K-2	0	9-C111.04B-1 to 9-C111.04B-4	0
6-C106.01L-1 to 6-C106.01L-2	0	10-X20-1/2	0
6-C106.01M-1 to 6-C106.01M-2	0	10-MX20.01A-1 to 10-MX20.01A-2	0
6-C106.01N-1 to 6-C106.01N-2	0	10-MX20.01B-1 to 10-MX20.01B-2	0
6-C106.01O-1 to 6-C106.01O-2	0	10-MX20.01C-1 to 10-MX20.01C-28	0
6-C106.01P-1 to 6-C106.01P-4	0	10-MX20.01CA-1 to 10-MX20.01CA-4	0
6-C106.01Q-1 to 6-C106.01Q-2	0	10-MX20.01D-1 to 10-MX20.01D-4	0
6-C106.01R-1 to 6-C106.01R-2	0	10-MX20.01DA-1 to 10-MX20.01DA-2	0
6-C106.02-1 to 6-C106.02-4	0	10-MX20.01DB-1 to 10-MX20.01DB-2	0
7-107-1/2	0	10-MX20.01DC-1 to 10-MX20.01DC-2	0
7-M107.01-1 to 7-M107.01-4	0	10-MX20.01DD-1 to 10-MX20.01DD-2	0
7-M107.02-1 to 7-M107.02-6	0	10-MX20.01DE-1 to 10-MX20.01DE-2	0
7-M107.02A-1 to 7-M107.02A-2	0	10-MX20.01DF-1 to 10-MX20.01DF-4	0
7-M107.03-1 to 7-M107.03-8	0	10-MX20.01E-1 to 10-MX20.01E-2	0
7-M107.04-1 to 7-M107.04-8	0	10-MX20.01F-1 to 10-MX20.01F-2	0
7-M107.04A-1 to 7-M107.04A-4	0	10-MX20.01G-1 to 10-MX20.01G-4	0
7-M107.05-1 to 7-M107.05-18	0	10-MX20.01GA-1 to 10-MX20.01GA-8	0
7-M107.05A-1 to 7-M107.05A-2	0	10-MX20.01GB-1 to 10-MX20.01GB-8	0
7-M107.06-1 to 7-M107.06-6	0	10-MX20.01H-1 to 10-MX20.01H-6	0
7-C107.01-1 to 7-C107.01-10	0	10-MX20.01HA-1 to 10-MX20.01HA-2	0
7-C107.02-1 to 7-C107.02-6	0	10-MX20.01HA1-1 to 10-MX20.01HA1-2	0

LIST OF EFFECTIVE PAGES (CONT)

Page No.	Change No.	Page No.	Change No.
10-MX20.01HA2-1 to 10-MX20.01HA2-4	0	10-MX20.01HN-1 to 10-MX20.01HN-2	0
10-MX20.01HA3-1 to 10-MX20.01HA3-2	0	10-MX20.01HN1-1 to 10-MX20.01HN1-2	0
10-MX20.01HA4-1 to 10-MX20.01HA4-2	0	10-MX20.01HO-1 to 10-MX20.01HO-2	0
10-MX20.01HA5-1 to 10-MX20.01HA5-2	0	10-MX20.01HO1-1 to 10-MX20.01HO1-2	0
10-MX20.01HB-1 to 10-MX20.01HB-2	0	10-MX20.01HO2-1 to 10-MX20.01HO2-2	0
10-MX20.01HB1-1 to 10-MX20.01HB1-2	0	10-MX20.01HO3-1 to 10-MX20.01HO3-2	0
10-MX20.01HB2-1 to 10-MX20.01HB2-2	0	10-MX20.01HO4-1 to 10-MX20.01HO4-2	0
10-MX20.01HB3-1 to 10-MX20.01HB3-2	0	10-MX20.01HP-1 to 10-MX20.01HP-2	0
10-MX20.01HC-1 to 10-MX20.01HC-2	0	10-MX20.01HP1-1 to 10-MX20.01HP1-2	0
10-MX20.01HC1-1 to 10-MX20.01HC1-2	0	10-MX20.01HQ-1 to 10-MX20.01HQ-2	0
10-MX20.01HC2-1 to 10-MX20.01HC2-2	0	10-MX20.01HQ1-1 to 10-MX20.01HQ1-2	0
10-MX20.01HC3-1 to 10-MX20.01HC3-2	0	10-MX20.01HQ2-1 to 10-MX20.01HQ2-2	0
10-MX20.01HD-1 to 10-MX20.01HD-2	0	10-MX20.01HQ3-1 to 10-MX20.01HQ3-2	0
10-MX20.01HD1-1 to 10-MX20.01HD1-2	0	10-MX20.01HR-1 to 10-MX20.01HR-2	0
10-MX20.01HD2-1 to 10-MX20.01HD2-2	0	10-MX20.01HR1-1 to 10-MX20.01HR1-10	0
10-MX20.01HD3-1 to 10-MX20.01HD3-2	0	10-MX20.01HS-1 to 10-MX20.01HS-2	0
10-MX20.01HD4-1 to 10-MX20.01HD4-2	0	10-CX20.01-1 to 10-CX20.01-2	0
10-MX20.01HD5-1 to 10-MX20.01HD5-2	0	11-121-1/2	0
10-MX20.01HE-1 to 10-MX20.01HE-2	0	11-M121.01-1 to 11-M121.01-14	0
10-MX20.01HE1-1 to 10-MX20.01HE1-2	0	11-M121.02-1 to 11-M121.02-10	0
10-MX20.01HE2-1 to 10-MX20.01HE2-2	0	11-M121.03-1 to 11-M121.03-14	0
10-MX20.01HE3-1 to 10-MX20.01HE3-2	0	11-M121.03A-1 to 11-M121.03A-2	0
10-MX20.01HE4-1 to 10-MX20.01HE4-2	0	11-M121.03B-1 to 11-M121.03B-8	0
10-MX20.01HE5-1 to 10-MX20.01HE5-2	0	11-M121.04-1 to 11-M121.04-8	0
10-MX20.01HF-1 to 10-MX20.01HF-2	0	11-M121.04A-1 to 11-M121.04A-2	0
10-MX20.01HF1-1 to 10-MX20.01HF1-2	0	11-M121.04B-1 to 11-M121.04B-2	0
10-MX20.01HF2-1 to 10-MX20.01HF2-2	0	11-M121.05-1 to 11-M121.05-12	0
10-MX20.01HF3-1 to 10-MX20.01HF3-2	0	11-M121.06-1 to 11-M121.06-10	0
10-MX20.01HF4-1 to 10-MX20.01HF4-2	0	11-M121.07-1 to 11-M121.07-8	0
10-MX20.01HF5-1 to 10-MX20.01HF5-2	0	11-M121.08-1 to 11-M121.08-6	0
10-MX20.01HG-1 to 10-MX20.01HG-2	0	11-M121.08A-1 to 11-M121.08A-2	0
10-MX20.01HG1-1 to 10-MX20.01HG1-2	0	11-M121.09-1 to 11-M121.09-8	0
10-MX20.01HG2-1 to 10-MX20.01HG2-2	0	11-C121.01-1 to 11-C121.01-12	0
10-MX20.01HH-1 to 10-MX20.01HH-2	0	11-C121.01A-1 to 11-C121.01A-4	0
10-MX20.01HH1-1 to 10-MX20.01HH1-4	0	11-C121.02-1 to 11-C121.02-6	0
10-MX20.01HH2-1 to 10-MX20.01HH2-2	0	11-C121.03-1 to 11-C121.03-6	0
10-MX20.01HI-1 to 10-MX20.01HI-2	0	11-C121.04-1 to 11-C121.04-12	0
10-MX20.01HI1-1 to 10-MX20.01HI1-2	0	11-C121.05-1 to 11-C121.05-2	0
10-MX20.01HI2-1 to 10-MX20.01HI2-2	0	12-122-1/2	0
10-MX20.01HJ-1 to 10-MX20.01HJ-2	0	12-M122.01-1 to 12-M122.01-6	0
10-MX20.01HJ1-1 to 10-MX20.01HJ1-2	0	12-M122.02-1 to 12-M122.02-10	0
10-MX20.01HJ2-1 to 10-MX20.01HJ2-2	0	12-M122.03-1 to 12-M122.03-6	0
10-MX20.01HK-1 to 10-MX20.01HK-2	0	12-M122.03A-1 to 12-M122.03A-2	0
10-MX20.01HK1-1 to 10-MX20.01HK1-2	0	12-M122.04-1 to 12-M122.04-6	0
10-MX20.01HK2-1 to 10-MX20.01HK2-2	0	12-M122.05-1 to 12-M122.05-10	0
10-MX20.01HK3-1 to 10-MX20.01HK3-2	0	12-M122.06-1 to 12-M122.06-2	0
10-MX20.01HL-1 to 10-MX20.01HL-2	0	12-C122.01-1 to 12-C122.01-8	0
10-MX20.01HM-1 to 10-MX20.01HM-2	0	13-123-1/2	0
10-MX20.01HM1-1 to 10-MX20.01HM1-2	0	13-M123.01-1 to 13-M123.01-10	0
10-MX20.01HM2-1 to 10-MX20.01HM2-2	0	13-M123.02-1 to 13-M123.02-18	0

LIST OF EFFECTIVE PAGES (CONT)

Page No.	Change No.	Page No.	Change No.
13-C123.01-1 to 13-C123.01-2	0	13-C123.03-1 to 13-C123.03-6	0
13-C123.02-1 to 13-C123.02-6	0		

FOREWORD AND PREFACE

1. **Issuing Authority.** This Instructional Guide (IG) A-CR-CCP-701/PF-001 was developed under the authority of the Director Cadets and Junior Canadian Rangers, and issued on the authority of the Chief of Defence Staff.
2. **Development.** Development of this IG was in accordance with the performance oriented concept of training outlined in the A-P9-050 Series, Canadian Forces Individual Training and Education System, with modifications to meet the needs of the Cadet Organization.
3. **Purpose of the IG.** The IG to be used by Royal Canadian Army Cadet Corps in conjunction with other resources to conduct the Green Star Program, including both Mandatory and Complementary Training. The IG provides instructors with the base means from which to deliver training. Individual IGs are to be reviewed in conjunction with the Lesson Specifications (LSs) found in Chapter 4 of A-CR-CCP-701/PG-001, *Royal Canadian Army Cadet Green Star Qualification Standard and Plan*, before instructing, so that each instructor can adequately plan for and prepare each lesson. The IG should then be used as the instructor's lesson plan after any adjustments are made during planning and preparation stages. Instructors may be required to develop instructional materials to support training in addition to any that may be provided, e.g. posters, videos, handouts, models, etc. supplemental to training control and support documents. Suggested instructional activities are included in most IGs to maximize learning and fun. Instructors are also encouraged to modify and/or enhance the activities, as long as they continue to contribute to enabling objectivity achievement.
4. **Use of the IG.** Throughout these instructional guides, a series of information boxes are used to highlight information; they include:



Note to the Instructor.



Key information to pass along to cadets.



Refer to the following CF regulations and policies.



Points of interest or special instructions the instructor should pass along to cadets.

5. **Suggested Changes.** Suggested changes to this document may be sent directly to cadetraining@canada.ca.

ADDITIONAL REFERENCES USED DURING DEVELOPMENT

EO MX01.01G

Acrylicdisplaystore.com (n.d.). Image of Plexiglas. Retrieved March 13, 2013 from <http://www.acrylicdisplaystore.com>

Ambercity.com (n.d.). Image of Stethoscope. Retrieved March 13, 2013 from <http://www.ambercity.com>

Answers.com (n.d.). Image of a Zipper. Retrieved March 13, 2013 from <http://www.answers.com>

Astrchem.org(n.d.). Image of DNA Sequencing. Retrieved March 13, 2013 from <http://astrochem.org>

Catalystoc.com (n.d.). Image of Pabulum. Retrieved March 13, 2013 from <https://catalystoc.com>

Clipartist.info (n.d.). Image of Goalie Mask. Retrieved March 13, 2013 from <http://clipartist.info>

Clubic.com (n.d.). Image of Blackberry. Retrieved March 13, 2013 from <http://www.clubic.com>

Coachesgeardirect.com (n.d.). Image of Pealess Whistle. Retrieved March 13, 2013 from <http://www.coachesgeardirect.com>

Commons. Wikimedia (n.d.). Image of Safety Pin. Retrieved March 13, 2013 from <http://commons.wikimedia.org>

Commons.wikimedia (n.d.). Image of Paper clip. Retrieved March 13, 2013 from <http://commons.wikimedia.org>

Commons.wikimedia (n.d.). Image of Pencil. Retrieved March 13, 2013 from <https://commons.wikimedia.org>

Gore-tex.com (n.d.). Image of Gore Tex sign. Retrieved March 13, 2013 from <http://www.gore-tex.com>

Howstuffworks.com (n.d.). Image of Artificial Heart. Retrieved March 13, 2013 from <http://science.howstuffworks.com>

Kabcotrading.com (n.d.). Image of Paint Roller. Retrieved March 13, 2013 from <http://kabcotrading.com>

Lubanpack.com (n.d.). Image of Garbage Bag. Retrieved March 13, 2013 from <http://www.lubanpack.com>

Made-in-china.com (n.d.). Image of Pencil sharpener. Retrieved March 13, 2013 from <http://www.made-in-china.com>

Meritshealth.com (n.d.). Image of Electric Wheelchair. Retrieved March 13, 2013 from <http://meritshealth.com>

MSN.com (n.d.). Image of Robertson Screw Retrieved March 13, 2013 from <http://money.ca.msn.com>

Oprah.com (n.d.). Image of Eyeglasses Retrieved. March 13, 2013 from <http://www.oprah.com>

Origami-kids.com (n.d.). Image of Glider. Retrieved March 13, 2013 from <http://origami-blog.origami-kids.com>

Recycledawblog (n.d.). Image of Egg Carton. Retrieved March 13, 2013 from <http://recycledawblog.blogspot.com>

Sagedata.com (n.d.). Image of a Bar Code. Retrieved March 13, 2013 from <http://www.sagedata.com>

Sritweets.com (n.d.). Image of Matchstick. Retrieved March 13, 2013 from <http://www.sritweets.com>

Thegreenbloggers.com (n.d.). Image of Tetra Pak. Retrieved March 13, 2013 from <http://thegreenbloggers.com>

Theheart.org (n.d.). Image of Heart Pacemaker. Retrieved March 13, 2013 from <http://www.theheart.org>

Tigerdirect.ca (n.d.). Image of an Electric Blanket. Retrieved March 13, 2013 from <http://tigerdirect.ca>

Tudiabetes.com (n.d.). Image of Insulin bottle. Retrieved March 13, 2013 from <http://www.tudiabetes.org>

Virtualaspirin.com (n.d.). Image of Aspirin. Retrieved March 13, 2013 from <http://www.virtualaspirin.com/>

Wikipedia (n.d.). Image of Lightbulb Retrieved March 13, 2013 from <http://en.wikipedia.org>

EO MX01.01H

Blogspot.com. (n.d.). Clip art image of shield. Retrieved March 19, 2013 from http://1.bp.blogspot.com/_IBTKv4gi5qA/TLSO0ReJmII/AAAAAAAAAE3s/g5RA77eD6c0/s1600/CTR+Shield+3.jpg

Blogspot.com. (n.d.). Image of Parliament of Canada. Retrieved March 18, 2013 from <http://4.bp.blogspot.com/-Z->

LrmOA5dNI/UC2F1VkJmIeI/AAAAAAAAAcc/DF1hpococa4/s1600/Parliament+of+Canada.jpg

CBC Online News. (2010). Image of Terry Fox. Retrieved March 13, 2013 from <http://www.cbc.ca/gfx/images/news/promos/2010/09/13/fox-cp-899916-275.jpg>

Clipartist.info. (n.d.). Illustration of soccer ball. Retrieved March 18, 2013 from http://clipartist.info/Art/colouringbook/soccer_ball-999px.png

Colour Your Own.com. (n.d.). Illustration of Newfoundland dog. Retrieved March 18, 2013 from http://color-your-own.com/printable_coloring_pages/newfielanding.jpg

CoworthFlexlands.ca.uk. (n.d.). Clipart image of Viking ship. Retrieved March 13, 2013, from <http://www.coworthflexlands.co.uk/viking%20ship.gif>

ElectricScotland.com. (n.d.) Image of Lord Strathcona. Retrieved March 13, 2013 from <http://www.electricscotland.com/images/img151.jpg>

FloraFinder.com. (n.d.). Clip art of sugar maple leaf. Retrieved March 15, 2013 from http://www.florafinder.com/Species/Pics/Sugar_Maple_Leaf_1.png

Florida Center for Educational Technology. (n.d.). Illustration of rose. Retrieved March 18, 2013 from http://etc.usf.edu/clipart/54900/54902/54902_rose.htm

Florida Center for Instructional Technology. (n.d.) Illustration of unicorn. Retrieved March 15, 2013 from http://etc.usf.edu/clipart/16800/16821/unicorn_16821_lg.gif

Fotodes.ru. (n.d.). Image of dairy cow. Retrieved March 18, 2013 from <http://fotodes.ru/upload/img1346175479.jpg>

John Hanley's Flickr page. (2009). Sunset Piper. Retrieved March 13, 2013 from <http://www.flickr.com/photos/johnhanleyphoto/4149452084/>

KY Post Online News. (2012) . Image of Asian Culture Fest. Retrieved March 15, 2013 from http://sharing.kypost.com/sharewcpo//photo/2012/04/11/Asian_Culture_Fest_20120411173648_320_240.JPG

LatimerGallery.com. (n.d.). Painting by Norval Morrissey. Retrieved March 13, 2013 from <http://www.lattimergallery.com>

Mummy in the City. (2012). Clip art image of treasure chest. Retrieved March 18, 2013 from <http://www.mummyinthecity.com/wp-content/uploads/2012/08/Treasure-chest.jpg>

My Hero.com. (2007). Image of Emily Carr. Retrieved March 15, 2013 from http://www.myhero.com/images/guest/g219387/hero58844/g219387_u82299_20071212-emily_carr.jpg

MyFathersHouse.ca (n.d.). Image of the Confederation bridge. Retrieved March 13, 2013 from <http://www.myfathershouse.ca>

RoadToAvonlea.com. (n.d.). Image of the origin of Canada's name. Retrieved March 13, 2013 from <http://roadtoavonlea.com/2012/08/turn-of-the-century-canada-interesting-facts/>

Société Historique de Saint-Boniface. (2010). Image of Louis Riel. Retrieved March 13, 2013, from http://shsb.mb.ca/system/files/Louis_Riel.gif

Story Soup Kids. (n.d.). Illustration of a beaver. Retrieved March 15, 2013 from <http://childstoryhour.com/images/coloring/Beaver.jpg>

SVC Online. (2008). Image of space shuttle launch. Retrieved March 13, 2013 from <http://blog.svconline.com/briefingroom/2008/06/26/space-shuttle-orbits-with-sm11/>

Wikipedia. (n.d.). Entry on the life of William Shatner and corresponding image. Retrieved March 15, 2013 from http://en.wikipedia.org/wiki/William_Shatner

Wikipedia. (n.d.) Entry on the life of Emily Carr. Retrieved March 15, 2013 from http://en.wikipedia.org/wiki/Emily_Carr

Wikipedia. (n.d.) Entry on the life of Emily Stowe and corresponding image. Retrieved March 15, 2013 from http://en.wikipedia.org/wiki/Emily_Stowe

Wikipedia. (n.d.) Entry on the life of Glenn Gould and corresponding image. Retrieved March 15, 2013 from http://en.wikipedia.org/wiki/Glenn_gould

Wikipedia. (n.d.). Entry on Cirque du Soleil and corresponding logo. Retrieved March 15, 2013 from http://en.wikipedia.org/wiki/Cirque_du_soleil

Wikipedia. (n.d.). Entry on the history of the Montreal Royals baseball team and corresponding logo. Retrieved March 16, 2013 from http://en.wikipedia.org/wiki/Montreal_Royals

Wikipedia. (n.d.). Entry on the life of Arthur Lipsett and corresponding image. Retrieved March 16, 2013 from http://en.wikipedia.org/wiki/Arthur_Lipsett

Wikipedia. (n.d.). Entry on the life of David Suzuki and corresponding image. Retrieved March 16, 2013 from http://en.wikipedia.org/wiki/David_Suzuki

Wikipedia. (n.d.). Entry on the life of Jacques Plante and corresponding image. Retrieved March 16, 2013 from http://en.wikipedia.org/wiki/Jacques_Plante

Wikipedia. (n.d.). Entry on the life of Margaret Atwood. Retrieved March 15, 2013 from http://en.wikipedia.org/wiki/Margaret_Atwood

Wikipedia. (n.d.). Entry on the life of Marshall MacLuhan and corresponding image. Retrieved March 16, 2013 from http://en.wikipedia.org/wiki/Marshall_MacLuhan

Wikipedia. (n.d.). Entry on the life of Romeo Dallaire and corresponding image. Retrieved March 16, 2013 from http://en.wikipedia.org/wiki/Romeo_Dallaire

Wikipedia. (n.d.). Entry on the life of Sir Frederick Banting and corresponding image. Retrieved March 15, 2013 from http://en.wikipedia.org/wiki/Frederick_Banting

Wordpress.com. (2012). Image of Margaret Atwood. Retrieved March 15, 2013 from <http://adoptsomom.files.wordpress.com/2012/01/margaretatwood1.gif>

www.HazeGray.org. (n.d.). Image of ORCA sea training vessel. Retrieved March 17, 2013 from <http://www.hazegray.org/navhist/canada/current/orca/>

YoPriceVille.com. (n.d.). Clipart of dragon. Retrieved March 18, 2013 from http://gallery.yopriceville.com/var/albums/Free-Clipart-Pictures/3D_Dragon_Clipart.png?m=1358684463

EO MX04.01

- About.com (2013). *Corpse pose – yoga poses*. Retrieved from <http://yoga.about.com/od/yogaposes/a/savasana.htm>
- About.com. (2013). *Step by step – cardio exercises for home workouts*. Retrieved from <http://exercise.about.com>
- About.com (2013). *Yoga poses*. Retrieved from <http://yoga.about.com/od/yogaposes/a/childspose.htm>
- Answers Corporation. (2013). *Curl up*. Retrieved from <http://www.answers.com/topic/curl-up>
- Beth Israel Deaconess Hospital-Milton. (2012). *Best shoveling tips from BID-Milton rehabilitation services*. Retrieved from <http://www.miltonhospital.org/images/stretch2.jpg>
- Blogger. (2012). *#55 – Jumping Jack Flash*. Retrieved from <http://4.bp.blogspot.com/-B8uBAc3uoC8/Tw4rJWuAMAI/AAAAAAAAAC8I/bZcwxuQvQ6Q/s1600/jumping+jack.jpg>
- Competitor Group Inc. (2013) *Five Technique Drills For Better Running*. Retrieved from http://triathlon.competitor.com/2010/09/training/five-technique-drills-for-better-running_12964/attachment/buttknicks
- Corbin, C., & Lindsey, R. (2007). *Fitness for life: Updated fifth edition*. Windsor, ON: Human Kinetics.
- Covey, Stephen (2004). *The 7 Habits of Highly Effective People*. Free Press.
- Exercise.com. (2013). *Leg sloop*. Retrieved from http://d3vs5ss8iow0ry.cloudfront.net/video-library/thumbnail/leg-sloop_-_step_1.max.v1.png
- Farmers of Canada. (2013) *What's in an egg?* Retrieved from <http://www.eggs.ca/egg-nutrition/whats-in-an-egg>
- Finger Lakes Fitness Center. (2011). *Perform the Perfect Push up*. Retrieved from <http://fingerlakesfitness.com>
- Fitness Perks LLC. (2012). *Focus on donkey kicks*. Retrieved from <http://www.pbfingers.com/wp-content/uploads/2012/02/donkey-kicks.jpg>
- Health Canada. (2011). *Eating well with Canada's food guide*. Retrieved from http://www.hc-sc.gc.ca/fn-an/alt_formats/hpfb-dgpsa/pdf/food-guide-aliment/print_eatwell_bienmang-eng.pdf
- Healthwise Incorporated. (2012). *Spondylolysis and spondylolisthesis: exercises*. Retrieved from <https://healthy.kaiserpermanente.org/health/care>
- HealthyFridge.org. (2009). *Kids' quiz!*. Retrieved from <http://www.healthyfridge.org/kids1.html>
- Health4y. (2011). *One exercise to lose your thigh fat*. Retrieved from <http://www.health4y.com/1-exercise-to-lose-your-thigh-fat/>
- how2muscleguide.com. (2013). *Shoulder Workout Routine*. Retrieved from <http://www.how2muscleguide.com/shoulder-workout-routine.html>
- Johnson, Brian (2010). *A Philosopher's notes*. Fountain Valley, CA: entheos Enterprises.
- Lau Gar Kung Fu. (2013) *Part 3 – Preparing to stretch*. Retrieved from <http://www.stafford-lau-gar.org/part3.html>
- Physical Arts. (2000). *Front kick (Right Stance)*. Retrieved from http://www.physical-arts.com/training/techniques/mn_front_kick_right.html
- Popsugar Inc. (2013). *The best core exercises for runners*. Retrieved from <http://www.fitsugar.com/Best-Core-Exercises-Runners-7102627>

Ratey, J. MD. (2008). *Spark: The revolutionary new science of exercise and the brain*. New York, NY: Little, Brown and Company.

Ron Johnson. (1996). *Office training exercises*. Retrieved from http://www.hockeyschoolonline.com/Jumping_running.htm

Scott, E. (2007). *25 More of the top stress relievers*. Retrieved from http://stress.about.com/od/tensiontamers/a/25_reliefers.htm

Spark People. (2012). *Portion distortion quiz*. Retrieved from http://www.sparkpeople.com/resource/quizzes_start.asp?quizid=32

Sharma, Robin (2009). *The greatness guide 2*. Scarborough, ON: Harper Collins.

Snapguide. (2013). *How to lose weight! BESTWORKOUTS From a personal trainer*. Retrieved from <http://snapguide.com/guides/lose-weight-best-workouts-from-a-personal-trainer/>

Stack. (2013). *The Michael Jordan tested core workout*. Retrieved from <http://basketball.stack.com/wp-content/uploads/2011/06/MJ-Core-Anterior-Reach-on-One-Leg.jpg>

Sun Key Publishing. (2013). *APFT calisthenics exercises*. Retrieved from http://www.militaryspot.com/enlist/apft_calisthenics_exercises/

Tolle, Eckhart (2004). *The power of now*. Oakland, CA:New World Library

Ultimate Franchises Ltd. (2012). *Benefits and proper execution of squats*. Retrieved from <http://www.ukbkickboxing.com/benefits-and-proper-execution-of-squats>

Weider Publications, LLC. (2013). *Bikini-belly bootcamp sculpt flat abs for summer with these fat-melting moves*. Retrieved from http://www.google.ca/imgres?imgurl=http://www.shape.com/sites/shape.com/files/imagecache/gallery_full_image/photo_gallery_picture_images

Women's Health. (2013). *Work out at home*. Retrieved from <http://www.womenshealthmag.com>

60 Days with Nat Jones. (2013). *FITNESSBUILDER*. Retrieved from <http://www.60dayswithnatjones.com>

EO MX04.02 & EO MX04.03

Anderson, B. (2000). *Stretching: 20th anniversary* (Rev. ed.). Bolinas, CA: Shelter Publications, Inc.

EO MX20.01H

Boston.com. (2013). Image of Canadian Soldiers at the Korean Front. Retrieved from http://www.boston.com/bigpicture/2010/06/remembering_the_korean_war_60.html

Bullyingawarenessweek.org. (N.D.) Image of Blue Beret Retrieved from http://www.bullyingawarenessweek.org/images/BE_the_Change_U-N_blue_beret.jpg

ImageShack.us. (N.D.) Image of Air Combat Systems Officer. Retrieved from <http://imageshack.us/photo/my-images/168/ck2009026310.jpg/>

JulianStockwin.com. (N.D.) Image of Cooks onboard HMCS Toronto. Retrieved from <http://www.julianstockwin.com/RCN.htm>

Lessignets.com. (n.d.). Image of Les forces canadiennes avançant vers Liri Valley. Retrieved from <http://www.lessignets.com/signetsdiane/calendrier/mai/23.htm>

MilitaryPhotos.net. (N.D.) Image of Aircraft Technician. Retrieved from <http://www.militaryphotos.net/forums/showthread.php?148107-Today-s-Pics!-Thursday-December-18-2008>

MilitaryPhotos.net. (N.D.) Image of Search and Rescue Technician. Retrieved from <http://www.militaryphotos.net/forums/showthread.php3F164000-Today-s-Pics!-Friday-August-28th-2009>.

MilitaryPhotos.net. (N.D.) Image of Medical Technician. Retrieved from <http://www.militaryphotos.net/forums/showthread.php3F164000-Today-s-Pics!-Friday-August-28th-2009>

Scott.AF.Mil. (N.D.) Image of a Dental Technician. Retrieved from <http://www.scott.af.mil/shared/media/photodb/photos/090810-F-6188A-051.JPG>

The Web Pages of Jerry Proc. (N.D.) Image of an ORCA Switchboard. Retrieved from <http://jproc.ca/rrp/rrp2/orca.html>

ThinkQuest.org. (N.D.) Image of a Weather Map. Retrieved from <http://library.thinkquest.org/C0112425/image/children/weathermap.jpg>

UNAC.org. (N.D.) Image of a UN Blue Beret. Retrieved from <http://www.unac.org/peacekeeping/en/un-peacekeeping/canada-and-un-peacekeeping/>

UN Website. (N.D.) English Poster Image. Retrieved from http://www.un.org/en/aboutun/pdf/2012%20English%20Every%20Day%20Poster_Web.pdf

UN Website. (N.D.) French Poster Image. Retrieved from <http://www.un.org/fr/aboutun/pdf/everydayposter2012.pdf>

Veterans.gc.ca (2012). Image of a train over the new railroad on Vimy Ridge. Retrieved from http://www.veterans.gc.ca/images/vimy90/galleries/02_behind_lines/02_soldier_work/work22_lg.jpg

Veterans.gc.ca (2012). Image of Canadian sleeping in the front line. Retrieved from http://www.veterans.gc.ca/images/vimy90/galleries/02_behind_lines/01_soldier_life/life21_lg.jpg

Veterans.gc.ca (2013). Image of the Battle of Vimy Ridge. Retrieved from <http://www.veterans.gc.ca/eng/feature/vimy-ridge>

Veterans.gc.ca (2013). Image of the Canadian National Vimy Memorial. Retrieved from http://www.veterans.gc.ca/eng/memorials/france/vimy/sg/02_behind_lines

Veterans.gc.ca (2011). Image of a Canadian plane during the Battle of Britain. Retrieved from <http://www.veterans.gc.ca/eng/history/secondwar/canada2/batbri>

Veterans.gc.ca (2012). Image of a poppy. Retrieved from <http://www.veterans.gc.ca/eng/feature/battle-atlantic>

Wikipedia.org (2011). Image of the Canadian Flag. Retrieved from http://en.wikipedia.org/wiki/File:Flag_of_Canada.svg

Wikipedia.org (2011). Image of the German Flag. Retrieved from http://en.wikipedia.org/wiki/File:Flag_of_Germany.svg

Veterans.gc.ca (2012). Image of the Battle of the Atlantic. Retrieved from <http://www.veterans.gc.ca/eng/feature/battle-atlantic>

Veterans.gc.ca (2012). Image of Depth charges being dropped by HMCS Saguenay. Retrieved from <http://www.veterans.gc.ca/eng/feature/battle-atlantic/history/gallery>

Wikipedia.org (2013). Image of an Observer Corps spotter scans the skies of London. Retrieved from http://en.wikipedia.org/wiki/Battle_of_Britain

Wikipedia.com. (2013). Image of the Battle of the Scheldt. Retrieved from http://en.wikipedia.org/wiki/Battle_of_the_Scheldt

Wikipedia.com. (2013). Image of Canadian Troops Advancing. Retrieved from http://en.wikipedia.org/wiki/World_war_I

Wikipedia.com. (2013). Image of Memorial Stained Glass RMC. Retrieved from http://en.wikipedia.org/wiki/List_of_Royal_Military_College_of_Canada_Memorials

Wikipedia.com. (2013). Image of Canadian Troops Advancing. Retrieved from http://en.wikipedia.org/wiki/World_war_I

Veterans.gc.ca. (2013). Image of the Canadian National Vimy Memorial. Retrieved from <http://www.veterans.gc.ca/images/geomapping/original/Vimy%20Ridge.JPG>

Wikipedia.com. (2013). Image of General Sir Arthur Currie. Retrieved from http://en.wikipedia.org/wiki/Arthur_Currie

Wikipedia.com. (2013). Image of Large scale-model of German trench lines. Retrieved from http://en.wikipedia.org/wiki/Battle_of_Vimy_Ridge#Background

WomenInUniform.tumblr.com. (N.D.) Image of a Pilot. Retrieved from <http://womeninuniform.tumblr.com/post/2072977741/canadian-air-force>

TABLE OF CONTENTS

		PAGE
CHAPTER 1	PO X01 – PARTICIPATE IN CITIZENSHIP ACTIVITIES	1-X01-1/2
Section 1	EO MX01.01A – PARTICIPATE IN A CITIZENSHIP TOUR.....	1-MX01.01A-1
Section 2	EO MX01.01B – ATTEND A PRESENTATION BY A COMMUNITY ORGANIZATION.....	1-MX01.01B-1
Section 3	EO MX01.01C – ATTEND A PRESENTATION BY A CITIZEN-OF-INTEREST.....	1-MX01.01C-1
Section 4	EO MX01.01D – PARTICIPATE IN THE CANADIAN CITIZENSHIP CHALLENGE.....	1-MX01.01D-1
Section 5	EO MX01.01E – HOST A CITIZENSHIP CEREMONY.....	1-MX01.01E-1
Section 6	EO MX01.01F – PARTICIPATE IN AN ELECTION.....	1-MX01.01F-1
Annex A	ELECTION INSTRUCTIONS.....	1-MX01.01FA-1
Annex B	GUIDE FOR ELECTION OFFICIALS.....	1-MX01.01FB-1
Annex C	MATERIALS FOR A REFERENDUM.....	1-MX01.01FC-1
Annex D	MATERIALS FOR AN ELECTION.....	1-MX01.01FD-1
Section 7	EO MX01.01G – PARTICIPATE IN HERITAGE MINUTES VIDEO ACTIVITIES.....	1-MX01.01G-1
Annex A	SUGGESTED HERITAGE MINUTES VIDEO ACTIVITIES: GENERAL..	1-MX01.01GA-1
Annex B	SUGGESTED ACTIVITY: FLAGS VIDEO.....	1-MX01.01GB-1
Appendix 1	DESIGN YOUR OWN FLAG.....	1-MX01.01GB1-1
Annex C	SUGGESTED ACTIVITIES: SAM STEELE VIDEO.....	1-MX01.01GC-1
Appendix 1	Entrance to Canada Exam.....	1-MX01.01GC1-1
Annex D	SUGGESTED ACTIVITY: NELLIE MCCLUNG VIDEO.....	1-MX01.01GD-1
Annex E	SUGGESTED ACTIVITIES: AVRO ARROW VIDEO.....	1-MX01.01GE-1
Appendix 1	CANADIAN or NOT?.....	1-MX01.01GE1-1
Annex F	SUGGESTED ACTIVITIES: GREY OWL VIDEO.....	1-MX01.01GF-1
Appendix 1	CANADA: “THE” PLACE TO LIVE!.....	1-MX01.01GF1-1
Annex G	SUGGESTED ACTIVITY: HERITAGE MINUTES VIDEO.....	1-MX01.01GG-1
Appendix 1	HERITAGE MINUTES VIDEO STORYBOARD TEMPLATE.....	1-MX01.01GG1-1
Section 8	EO MX01.01H – PARTICIPATE IN CITIZENSHIP LEARNING STATIONS.....	1-MX01.01H-1
Annex A	RIGHTS AND RESPONSIBILITIES OF CITIZENS.....	1-MX01.01HA-1
Appendix 1	INSTRUCTIONS: RIGHTS AND RESPONSIBILITIES.....	1-MX01.01HA1-1
Appendix 2	RIGHTS AND RESPONSIBILITIES OF CANADIAN CITIZENS.....	1-MX01.01HA2-1
Appendix 3	RIGHTS AND RESPONSIBILITIES OF CANADIAN CITIZENS – CITIZENS' WALL.....	1-MX01.01HA3-1
Annex B	THE GREAT CANADIAN TRIVIA GAME.....	1-MX01.01HB-1
Appendix 1	WELCOME TO THE GREAT CANADIAN TRIVIA GAME!.....	1-MX01.01HB1-1

TABLE OF CONTENTS (Cont)

	PAGE
Appendix 2	1-MX01.01HB2-1
Annex C HISTORY OF CANADA IN 30 MIN OR LESS.....	1-MX01.01HC-1
Appendix 1 HISTORY OF CANADA IN 30 MINUTES OR LESS	1-MX01.01HC1-1
Appendix 2 HISTORY OF CANADA IN 30 MINUTES OR LESS – ANSWER KEY... ..	1-MX01.01HC2-1
Annex D CANADIAN CONTRIBUTIONS: PARKING SPACES.....	1-MX01.01HD-1
Appendix 1 PARKING SPACES INSTRUCTIONS.....	1-MX01.01HD1-1
Appendix 2 PARKING SPACES ANSWERS AND FACTS.....	1-MX01.01HD2-1
Appendix 3	1-MX01.01HD3-1
Annex E CANADIAN CONTRIBUTIONS: GREAT CANADIANS.....	1-MX01.01HE-1
Appendix 1 CANADIAN CONTRIBUTIONS INSTRUCTIONS.....	1-MX01.01HE1-1
Appendix 2 CANADIAN CONTRIBUTORS.....	1-MX01.01HE2-1
Annex F HOW CANADIANS GOVERN THEMSELVES.....	1-MX01.01HF-1
Appendix 1 SAMPLE RESOLUTIONS.....	1-MX01.01HF1-1
Annex G ELECTIONS.....	1-MX01.01HG-1
Appendix 1 JOB POSTING FOR CANDIDATES.....	1-MX01.01HG1-1
Annex H CANADIAN JUSTICE SYSTEM.....	1-MX01.01HH-1
Appendix 1 The Canadian Justice SYSTEM.....	1-MX01.01HH1-1
Appendix 2 The Canadian Justice System.....	1-MX01.01HH2-1
Appendix 3 Our New Laws.....	1-MX01.01HH3-1
Annex I CANADIAN SYMBOLS: TREASURE HUNT.....	1-MX01.01HI-1
Appendix 1 Treasure Hunt Set-Up Diagrams.....	1-MX01.01HI1-1
Appendix 2 CANADIAN SYMBOLS – TREASURE HUNT! – INSTRUCTIONS.....	1-MX01.01HI2-1
Appendix 3 CANADIAN SYMBOLS – TREASURE HUNT! – START HERE!.....	1-MX01.01HI3-1
Appendix 4	1-MX01.01HI4-1
Appendix 5 TREASURE HUNT SECRET WORD SHEET.....	1-MX01.01HI5-1
Appendix 6 TREASURE HUNT SECRET WORD ANSWER KEY.....	1-MX01.01HI6-1
Annex J CANADIAN SYMBOLS: COAT OF ARMS CHALLENGE.....	1-MX01.01HJ-1
Appendix 1 COAT OF ARMS CHALLENGE.....	1-MX01.01HJ1-1
Appendix 2 About Our Coat of Arms.....	1-MX01.01HJ2-1
Appendix 3 COAT OF ARMS CHALLENGE WORKSHEET.....	1-MX01.01HJ3-1
Appendix 4 COAT OF ARMS OF THE NATION OF.....	1-MX01.01HJ4-1
Annex K CANADA'S ECONOMY.....	1-MX01.01HK-1
Appendix 1 CANADA'S ECONOMY INSTRUCTION.....	1-MX01.01HK1-1
Appendix 2 CANADA'S ECONOMY OVERVIEW.....	1-MX01.01HK2-1
Appendix 3 CANADA'S ECONOMY WORKSHEET.....	1-MX01.01HK3-1
Annex L CANADA'S REGIONS: SYMBOLS MAP.....	1-MX01.01HL-1

TABLE OF CONTENTS (Cont)

		PAGE
Appendix 1	REGIONAL SYMBOLS.....	1-MX01.01HL1-1
Appendix 2	CANADA'S REGIONS.....	1-MX01.01HL2-1
Appendix 3	1-MX01.01HL3-1
Appendix 4	CANADA'S REGIONS SYMBOLS.....	1-MX01.01HL4-1
Appendix 5	CANADA'S REGIONS ANSWER KEY.....	1-MX01.01HL5-1
Annex M	CANADA'S REGIONS: WORKSHEET.....	1-MX01.01HM-1
Appendix 1	CANADA'S REGIONS INSTRUCTIONS.....	1-MX01.01HM1-1
Appendix 2	CANADA'S REGIONS KWL CHART.....	1-MX01.01HM2-1
Appendix 3	CANADA'S REGIONS OVERVIEW.....	1-MX01.01HM3-1
Appendix 4	CANADA'S REGIONS WORKSHEET.....	1-MX01.01HM4-1
Section 9	EO CX01.01 – PARTICIPATE IN CITIZENSHIP ACTIVITIES.....	1-CX01.01-1
CHAPTER 2	PO X02 – PERFORM COMMUNITY SERVICE	2-X02-1/2
Section 1	EO MX02.01 – PERFORM COMMUNITY SERVICE.....	2-MX02.01-1
Annex A	The Five Stages of Service Learning.....	2-MX02.01A-1
Annex B	Personal Inventory.....	2-MX02.01B-1
Annex C	Community Service Proposal.....	2-MX02.01C-1
Annex D	Four Square Reflection Tool.....	2-MX02.01D-1
Annex E	Community Service Checklist.....	2-MX02.01E-1
Annex F	Examples of Community Service.....	2-MX02.01F-1
Section 2	EO CX02.01 – PERFORM COMMUNITY SERVICE.....	2-CX02.01-1
CHAPTER 3	PO 103 – PARTICIPATE AS A MEMBER OF A TEAM	3-103-1/2
Section 1	EO M103.01 – IDENTIFY THE RESPONSIBILITIES OF A FOLLOWER IN A TEAM.....	3-M103.01-1
Attachment A	SCRAMBLED WORDS.....	3-M103.01A-1
Section 2	EO M103.02 – MAP A PERSONAL GOAL FOR THE TRAINING YEAR	3-M103.02-1
Attachment A	SMART Goal.....	3-M103.02A-1
Section 3	EO M103.03 – PARTICIPATE IN TEAMBUILDING ACTIVITIES.....	3-M103.03-1
Attachment A	3-M103.03A-1
Section 4	EO C103.01 – PARTICIPATE IN ICEBREAKER ACTIVITIES.....	3-C103.01-1
Section 5	EO C103.02 – PARTICIPATE IN SELF INTRODUCTIONS.....	3-C103.02-1
Section 6	EO C103.03 – PARTICIPATE IN TEAMBUILDING ACTIVITIES.....	3-C103.03-1
Attachment A	3-C103.03A-1
CHAPTER 4	PO X04 – TRACK PARTICIPATION IN PHYSICAL ACTIVITIES	4-X04-1/2
Section 1	EO MX04.01 – PARTICIPATE IN 60 MINUTES OF MODERATE- TO VIGOROUS-INTENSITY PHYSICAL ACTIVITY (MVPA) AND TRACK PARTICIPATION IN PHYSICAL ACTIVITIES.....	4-MX04.01-1

TABLE OF CONTENTS (Cont)

	PAGE
Annex A	WARM-UP..... 4-MX04.01A-1
Appendix 1 4-MX04.01A1-1
Annex B	COOL-DOWN..... 4-MX04.01B-1
Appendix 1	SAMPLE STRETCHES..... 4-MX04.01B1-1
Annex C 4-MX04.01C-1
Appendix 1 4-MX04.01C1-1
Appendix 2 4-MX04.01C2-1
Appendix 3 4-MX04.01C3-1
Annex D	LEARNING STATION 1: CANADIAN PHYSICAL ACTIVITY GUIDELINES AND CANADIAN SEDENTARY BEHAVIOUR GUIDELINES..... 4-MX04.01D-1
Appendix 1	CANADIAN PHYSICAL ACTIVITY GUIDELINES..... 4-MX04.01D1-1
Appendix 2	CANADIAN SEDENTARY BEHAVIOUR GUIDELINES..... 4-MX04.01D2-1
Appendix 3 4-MX04.01D3-1
Annex E	LEARNING STATION 2: NUTRITION JEOPARDY..... 4-MX04.01E-1
Appendix 1	JEOPARDY GAME BOARD..... 4-MX04.01E1-1
Appendix 2 4-MX04.01E2-1
Appendix 3	EATING WELL WITH CANADA'S FOOD GUIDE..... 4-MX04.01E3-1
Annex F	LEARNING STATION 3: STRESS..... 4-MX04.01F-1
Appendix 1 4-MX04.01F1-1
Annex G	LEARNING STATION 4: HEALTHY LIFESTYLE TOOL BELT..... 4-MX04.01G-1
Appendix 1	HEALTHY LIFESTYLE TOOL BELT..... 4-MX04.01G1-1
Annex H	PHYSICAL ACTIVITY TRACKER..... 4-MX04.01H-1
Section 2	EO MX04.02 – IDENTIFY STRATEGIES TO IMPROVE PARTICIPATION IN PHYSICAL ACTIVITIES AND PARTICIPATE IN THE CADET FITNESS ASSESSMENT..... 4-MX04.02-1
Annex A	GOAL SETTING..... 4-MX04.02A-1
Appendix 1	SMART GOALS GUIDE..... 4-MX04.02A1-1
Section 3	EO MX04.03 – PARTICIPATE IN THE CADET FITNESS ASSESSMENT AND IDENTIFY STRATEGIES FOR IMPROVING PERSONAL PHYSICAL FITNESS..... 4-MX04.03-1
Annex A	STRATEGIES TO IMPROVE MY PERSONAL PHYSICAL FITNESS..... 4-MX04.03A-1
Annex B	PHYSICAL ACTIVITIES CADETS CAN DO TO IMPROVE THEIR PERSONAL FITNESS..... 4-MX04.03B-1
Section 4	EO CX04.01 – PARTICIPATE IN THE CADET FITNESS ASSESSMENT AND IDENTIFY STRATEGIES FOR IMPROVING PERSONAL PHYSICAL FITNESS..... 4-CX04.01-1
Section 5	EO CX04.02 – PARTICIPATE IN ACTIVITIES THAT REINFORCE THE THREE COMPONENTS OF PHYSICAL FITNESS..... 4-CX04.02-1

TABLE OF CONTENTS (Cont)

	PAGE
Annex A	4-CX04.02A-1
Annex B	4-CX04.02B-1
Annex C	4-CX04.02C-1
Section 6 EO CX04.03 – PARTICIPATE IN A COOKING CLASS.....	4-CX04.03-1
Section 7 EO CX04.04 – ATTEND A PERSONAL FITNESS AND HEALTHY LIVING PRESENTATION.....	4-CX04.04-1
Section 8 EO CX04.05 – ATTEND A LOCAL AMATEUR SPORTING EVENT.....	4-CX04.05-1
CHAPTER 5 PO X05 – PARTICIPATE IN PHYSICAL ACTIVITIES	5-X05-1/2
Section 1 EO MX05.01 – PARTICIPATE IN PHYSICAL ACTIVITIES.....	5-MX05.01-1
Attachment A AEROBICS.....	5-MX05.01A-1
Attachment B CROSS-COUNTRY SKIING.....	5-MX05.01B-1
Attachment C HIKING.....	5-MX05.01C-1
Attachment D ICE SKATING.....	5-MX05.01D-1
Attachment E INSTRUCTOR-LED DANCING.....	5-MX05.01E-1
Attachment F ORIENTEERING.....	5-MX05.01F-1
Attachment G ROLLERBLADING.....	5-MX05.01G-1
Attachment H RUNNING.....	5-MX05.01H-1
Attachment I SKIPPING ROPE.....	5-MX05.01I-1
Attachment J SHOWSHOEING.....	5-MX05.01J-1
Attachment K SWIMMING.....	5-MX05.01K-1
Attachment L MUSCULAR STRENGTH EXERCISES USING THE BODY, BALANCE BALLS, RESISTANCE BANDS, AND WEIGHTED BALLS AND BARS..	5-MX05.01L-1
Attachment M PILATES.....	5-MX05.01M-1
Attachment N STRETCHING.....	5-MX05.01N-1
Attachment O TAI CHI.....	5-MX05.01O-1
Attachment P YOGA.....	5-MX05.01P-1
Attachment Q BASEBALL.....	5-MX05.01Q-1
Attachment R BASKETBALL.....	5-MX05.01R-1
Attachment S FLOOR HOCKEY.....	5-MX05.01S-1
Attachment T FOOTBALL (FLAG / TOUCH).....	5-MX05.01T-1
Attachment U LACROSSE.....	5-MX05.01U-1
Attachment V RINGETTE (OFF ICE VERSION).....	5-MX05.01V-1
Attachment W SOCCER.....	5-MX05.01W-1
Attachment X SOCCER BASEBALL / KICKBALL.....	5-MX05.01X-1
Attachment Y SOFTBALL.....	5-MX05.01Y-1
Attachment Z ULTIMATE FRISBEE.....	5-MX05.01Z-1

TABLE OF CONTENTS (Cont)

		PAGE
Attachment AA	VOLLEYBALL.....	5-MX05.01AA-1
Attachment AB	ACTIVE GAMES.....	5-MX05.01AB-1
Attachment AC	CIRCUIT TRAINING.....	5-MX05.01AC-1
Attachment AD	MARTIAL ARTS.....	5-MX05.01AD-1
Attachment AE	TABLOIDS.....	5-MX05.01AE-1
Section 2	EO CX05.01 – PARTICIPATE IN PHYSICAL ACTIVITIES.....	5-CX05.01-1
Section 3	EO CX05.02 – PARTICIPATE IN A TOURNAMENT.....	5-CX05.02-1
Attachment A	ROUND ROBIN TOURNAMENT.....	5-CX05.02A-1
Attachment B	LADDER TOURNAMENT.....	5-CX05.02B-1
Attachment C	PYRAMID TOURNAMENT.....	5-CX05.02C-1
Attachment D	SINGLE ELIMINATION TOURNAMENT.....	5-CX05.02D-1
Attachment E	DOUBLE ELIMINATION TOURNAMENT.....	5-CX05.02E-1
CHAPTER 6	PO 106 – FIRE THE CADET AIR RIFLE	6-106-1/2
Section 1	EO M106.01 – IDENTIFY THE PARTS AND CHARACTERISTICS OF THE DAISY 853C AIR RIFLE.....	6-M106.01-1
Attachment A	PARTS AND CHARACTERISTICS OF THE CADET AIR RIFLE.....	6-M106.01A-1
Section 2	EO M106.02 – CARRY OUT SAFETY PRECAUTIONS ON THE CADET AIR RIFLE.....	6-M106.02-1
Section 3	EO M106.03 – APPLY BASIC MARKSMANSHIP TECHNIQUES.....	6-M106.03-1
Section 4	EO M106.04 – FOLLOW RULES AND COMMANDS ON AN AIR RIFLE RANGE.....	6-M106.04-1
Annex A	RANGE COMMANDS.....	6-M106.04A-1
Section 5	EO M106.05 – PARTICIPATE IN MARKSMANSHIP FAMILIARIZATION USING THE CADET AIR RIFLE.....	6-M106.05-1
Section 6	EO C106.01 – PARTICIPATE IN A RECREATIONAL MARKSMANSHIP ACTIVITY.....	6-C106.01-1
Attachment A	RECREATIONAL MARKSMANSHIP ACTIVITIES.....	6-C106.01A-1
Attachment B	CLASSIFICATION.....	6-C106.01B-1
Attachment C	PYRAMID.....	6-C106.01C-1
Attachment D	BEACH BALL.....	6-C106.01D-1
Attachment E	BALLOONS.....	6-C106.01E-1
Attachment F	RACK'EM UP.....	6-C106.01F-1
Attachment G	LIGHTS OUT.....	6-C106.01G-1
Attachment H	SAVE THE DAY.....	6-C106.01H-1
Attachment I	FLOWER POT.....	6-C106.01I-1
Attachment J	CHASE THE DOTS.....	6-C106.01J-1
Attachment K	SPEED GRID.....	6-C106.01K-1

TABLE OF CONTENTS (Cont)

		PAGE
Attachment L	BEAT THE CLOCK.....	6-C106.01L-1
Attachment M	DARTBOARD.....	6-C106.01M-1
Attachment N	CUT THE FUSES.....	6-C106.01N-1
Attachment O	SHOO-FLY.....	6-C106.01O-1
Attachment P	GOOD BREAK.....	6-C106.01P-1
Attachment Q	SIMULATED STAGE 1 CHAMPIONSHIP.....	6-C106.01Q-1
Attachment R	SIMULATED STAGE 2 CHAMPIONSHIP.....	6-C106.01R-1
Section 7	EO C106.02 – CLEAN AND STORE THE CADET AIR RIFLE.....	6-C106.02-1
CHAPTER 7	PO 107 – SERVE IN AN ARMY CADET CORPS	7-107-1/2
Section 1	EO M107.01 – PARTICIPATE IN A DISCUSSION ON YEAR ONE TRAINING.....	7-M107.01-1
Section 2	EO M107.02 – IDENTIFY ARMY CADET RANKS AND OFFICER RANKS.....	7-M107.02-1
Attachment A	CADET AND CANADIAN ARMY OFFICER RANKS.....	7-M107.02A-1
Section 3	EO M107.03 – OBSERVE THE RULES AND PROCEDURES FOR THE PAYING OF COMPLIMENTS.....	7-M107.03-1
Section 4	EO M107.04 – STATE THE AIM AND THE MOTTO OF THE ARMY CADET PROGRAM.....	7-M107.04-1
Annex A	PUZZLES.....	7-M107.04A-1
Section 5	EO M107.05 – WEAR THE ARMY CADET UNIFORM.....	7-M107.05-1
Annex A	UNIFORM PIECES.....	7-M107.05A-1
Section 6	EO M107.06 - PARTICIPATE IN A DISCUSSION ON YEAR ONE SUMMER TRAINING OPPORTUNITIES.....	7-M107.06-1
Section 7	EO C107.01 – MAINTAIN THE ARMY CADET UNIFORM.....	7-C107.01-1
Section 8	EO C107.02 – PARTICIPATE IN A TOUR OF THE CADET CORPS.....	7-C107.02-1
Annex A	EXAMPLE MAP.....	7-C107.02A-1
Annex B	CORPS PASSPORT.....	7-C107.02B-1
Section 9	EO C107.03 – PARTICIPATE IN AN ACTIVITY ON THE HISTORY OF THE CADET CORPS.....	7-C107.03-1
Annex A	MEMORIAL AWARDS.....	7-C107.03A-1
Section 10	EO C107.04 – ESTABLISH A FULL VALUE CONTRACT.....	7-C107.04-1
Annex A	WAYS TO REPRESENT THE FULL VALUE CONTRACT.....	7-C107.04A-1
CHAPTER 8	PO 108 – PERFORM DRILL MOVEMENTS DURING AN ANNUAL CEREMONIAL REVIEW	8-108-1/2
Section 1	EO M108.01 – ADOPT THE POSITIONS OF ATTENTION, STAND AT EASE AND STAND EASY.....	8-M108.01-1
Section 2	EO M108.02 – EXECUTE A SALUTE AT THE HALT WITHOUT ARMS.	8-M108.02-1
Section 3	EO M108.03 – EXECUTE TURNS AT THE HALT.....	8-M108.03-1

TABLE OF CONTENTS (Cont)

		PAGE
Section 4	EO M108.04 – CLOSE TO THE RIGHT AND LEFT.....	8-M108.04-1
Section 5	EO M108.05 – EXECUTE PACES FORWARD AND TO THE REAR.....	8-M108.05-1
Section 6	EO M108.06 – EXECUTE THE MOVEMENTS REQUIRED FOR A RIGHT DRESS.....	8-M108.06-1
Section 7	EO M108.07 – EXECUTE AN OPEN ORDER AND CLOSE ORDER MARCH.....	8-M108.07-1
Section 8	EO M108.08 – MARCH AND HALT IN QUICK TIME.....	8-M108.08-1
Section 9	EO M108.09 – EXECUTE MARKING TIME, FORWARD AND HALTING IN QUICK TIME.....	8-M108.09-1
Section 10	EO M108.10 – EXECUTE A SALUTE ON THE MARCH.....	8-M108.10-1
Section 11	EO M108.11 – PAY COMPLIMENTS WITH A SQUAD ON THE MARCH.....	8-M108.11-1
Section 12	EO M108.12 – PERFORM DRILL MOVEMENTS DURING AN ANNUAL CEREMONIAL REVIEW.....	8-M108.12-1
Section 13	EO C108.01 – EXECUTE SUPPLEMENTARY DRILL MOVEMENTS....	8-C108.01-1
Section 14	EO C108.02 – PARTICIPATE IN A DRILL COMPETITION.....	8-C108.02-1
Attachment A	GUIDELINES FOR THE CONDUCT OF A YEAR ONE DRILL COMPETITION.....	8-C108.02A-1
Attachment B	DRILL SEQUENCE.....	8-C108.02B-1
Attachment C	DRILL COMPETITION MARKING GUIDE.....	8-C108.02C-1
Attachment D	DRILL COMPETITION MARKING SHEET.....	8-C108.02D-1
CHAPTER 9	PO 111 – PARTICIPATE IN RECREATIONAL SUMMER BIATHLON ACTIVITIES	9-111-1/2
Section 1	EO C111.01 - PARTICIPATE IN A BIATHLON BRIEFING.....	9-C111.01-1
Section 2	EO C111.02 – RUN WIND SPRINTS.....	9-C111.02-1
Attachment A	SAMPLE STRETCHES.....	9-C111.02A-1
Section 3	EO C111.03 – SIMULATE FIRING THE CADET AIR RIFLE FOLLOWING PHYSICAL ACTIVITY.....	9-C111.03-1
Section 4	EO C111.04 - PARTICIPATE IN A RECREATIONAL SUMMER BIATHLON ACTIVITY.....	9-C111.04-1
Annex A	Guidelines to Conduct a Recreational Summer Biathlon Activity.....	9-C111.04A-1
Annex B	COURSE CONTROL SHEET.....	9-C111.04B-1
CHAPTER 10	PO X20 – PARTICIPATE IN CAF FAMILIARIZATION ACTIVITIES	10-X20-1/2
Section 1	EO MX20.01A – PARTICIPATE IN A CAF ACTIVITY.....	10-MX20.01A-1
Section 2	EO MX20.01B – PARTICIPATE IN A CAF FAMILIARIZATION TOUR.....	10-MX20.01B-1
Section 3	EO MX20.01C – FIRE THE C7 RIFLE.....	10-MX20.01C-1
Attachment A	C7 RIFLE HANDLING TEST.....	10-MX20.01CA-1
Section 4	EO MX20.01D – PARTICIPATE IN A MESS DINNER.....	10-MX20.01D-1

TABLE OF CONTENTS (Cont)

	PAGE
Annex A	SEA CADET MESS DINNER..... 10-MX20.01DA-1
Annex B	ARMY CADET MESS DINNER..... 10-MX20.01DB-1
Annex C	AIR CADET MESS DINNER..... 10-MX20.01DC-1
Annex D	ROLE OF THE PRESIDENT OF THE MESS COMMITTEE (PMC)..... 10-MX20.01DD-1
Annex E	ROLE OF THE VICE-PRESIDENT OF THE MESS COMMITTEE (VPMC)..... 10-MX20.01DE-1
Annex F	ORGANIZE A MESS DINNER AIDE-MEMOIRE..... 10-MX20.01DF-1
Section 5	EO MX20.01E – ATTEND A CAF PRESENTATION..... 10-MX20.01E-1
Section 6	EO MX20.01F – ATTEND A CAF COMMEMORATIVE CEREMONY..... 10-MX20.01F-1
Section 7	EO MX20.01G – PARTICIPATE IN CAF FAMILIARIZATION VIDEO ACTIVITIES..... 10-MX20.01G-1
Annex A 10-MX20.01GA-1
Annex B 10-MX20.01GB-1
Section 8	EO MX20.01H – PARTICIPATE IN CAF FAMILIARIZATION LEARNING STATIONS..... 10-MX20.01H-1
Annex A	CANADIAN ARMED FORCES (CAF) HISTORY..... 10-MX20.01HA-1
Appendix 1	HISTORY OF THE CAF TIMELINE.....10-MX20.01HA1-1
Appendix 210-MX20.01HA2-1
Appendix 3	STATEMENTS FOR THE HISTORY OF THE CAF TIMELINE.....10-MX20.01HA3-1
Appendix 4	HISTORY OF THE CAF TIMELINE – ANSWER KEY.....10-MX20.01HA4-1
Appendix 5	STATEMENTS FOR THE HISTORY OF THE CANADIAN FORCES TIMELINE – ANSWER KEY.....10-MX20.01HA5-1
Annex B	CANADIAN ARMED FORCES (CAF) HISTORY..... 10-MX20.01HB-1
Appendix 1	CANADA REMEMBERS TIMES (2011).....10-MX20.01HB1-1
Appendix 2	KEY WORD SHEET.....10-MX20.01HB2-1
Appendix 3	KEY WORD SHEET – ANSWER KEY.....10-MX20.01HB3-1
Annex C	CANADIAN ARMED FORCES (CAF) HISTORY..... 10-MX20.01HC-1
Appendix 110-MX20.01HC1-1
Appendix 210-MX20.01HC2-1
Appendix 310-MX20.01HC3-1
Annex D	BATTLE OF THE ATLANTIC..... 10-MX20.01HD-1
Appendix 1	Battleship Board Game.....10-MX20.01HD1-1
Appendix 2	BATTLESHIP RULES.....10-MX20.01HD2-1
Appendix 3	BATTLESHIP QUESTIONS A.....10-MX20.01HD3-1
Appendix 4	BATTLESHIP QUESTIONS B.....10-MX20.01HD4-1
Appendix 5	BATTLE OF THE ATLANTIC.....10-MX20.01HD5-1
Annex E	BATTLE OF VIMY RIDGE..... 10-MX20.01HE-1

TABLE OF CONTENTS (Cont)

	PAGE
Appendix 1	Battletank Board Game10-MX20.01HE1-1
Appendix 2	BATTLETANK RULES.....10-MX20.01HE2-1
Appendix 3	BATTLETANK QUESTIONS A.....10-MX20.01HE3-1
Appendix 4	BATTLETANK QUESTIONS B.....10-MX20.01HE4-1
Appendix 5	BATTLE OF VIMY RIDGE.....10-MX20.01HE5-1
Annex F	BATTLE OF BRITAIN..... 10-MX20.01HF-1
Appendix 1	Battleplane Board Game.....10-MX20.01HF1-1
Appendix 2	BATTLEPLANE RULES.....10-MX20.01HF2-1
Appendix 3	BATTLEPLANE QUESTIONS A.....10-MX20.01HF3-1
Appendix 4	BATTLEPLANE QUESTIONS B.....10-MX20.01HF4-1
Appendix 5	BATTLE OF BRITAIN.....10-MX20.01HF5-1
Annex G	BATTLE OF THE ATLANTIC..... 10-MX20.01HG-1
Appendix 1	Canada Remembers the Battle of the Atlantic.....10-MX20.01HG1-1
Appendix 2	CANADA REMEMBERS THE BATTLE OF THE ATLANTIC QUESTIONS AND ANSWERS.....10-MX20.01HG2-1
Annex H	BATTLE OF VIMY RIDGE..... 10-MX20.01HH-1
Appendix 1	WORLD WAR I – THE BATTLE OF VIMY RIDGE QUESTIONS AND ANSWERS.....10-MX20.01HH1-1
Appendix 2	World War I – The Battle of Vimy Ridge.....10-MX20.01HH2-1
Annex I	BATTLE OF BRITAIN..... 10-MX20.01HI-1
Appendix 1	THE BATTLE OF BRITAIN..... 10-MX20.01HI1-1
Appendix 2	THE BATTLE OF BRITAIN QUESTIONS AND ANSWERS..... 10-MX20.01HI2-1
Annex J	BRITISH COMMONWEALTH AIR TRAINING PLAN (BCATP)..... 10-MX20.01HJ-1
Appendix 1	CANADA REMEMBERS THE BRITISH COMMONWEALTH AIR TRAINING PLAN.....10-MX20.01HJ1-1
Appendix 2	CANADA REMEMBERS THE BRITISH COMMONWEALTH AIR TRAINING PLAN QUESTIONS AND ANSWERS.....10-MX20.01HJ2-1
Annex K	ROLES OF THE CANADIAN ARMED FORCES (CAF)..... 10-MX20.01HK-1
Appendix 1	FACT SHEET – DEFENDING CANADA.....10-MX20.01HK1-1
Appendix 2	FACT SHEET – DEFENDING NORTH AMERICA.....10-MX20.01HK2-1
Appendix 3	FACT SHEET – CONTRIBUTING TO INTERNATIONAL PEACE AND SECURITY.....10-MX20.01HK3-1
Annex L	ROLES OF THE CANADIAN ARMED FORCES (CAF) – DEFENDING CANADA..... 10-MX20.01HL-1
Annex M	ROLES OF THE CANADIAN ARMED FORCES (CAF) – DEFENDING NORTH AMERICA..... 10-MX20.01HM-1
Appendix 1	DEFENDING NORTH AMERICA – A STRONG AND RELIABLE PARTNER.....10-MX20.01HM1-1

TABLE OF CONTENTS (Cont)

		PAGE
Appendix 2	DEFENDING NORTH AMERICA – A STRONG AND RELIABLE PARTNER – ANSWER KEY.....	10-MX20.01HM2-1
Annex N	ROLES OF THE CANADIAN ARMED FORCES (CAF) – CONTRIBUTING TO INTERNATIONAL PEACE AND SECURITY.....	10-MX20.01HN-1
Appendix 1	CONTRIBUTING TO INTERNATIONAL PEACE AND SECURITY INSTRUCTION SHEET.....	10-MX20.01HN1-1
Annex O	CURRENT CANADIAN ARMED FORCES (CAF).....	10-MX20.01HO-1
Appendix 1	DEFEND CANADA'S ARCTIC TERRITORIES AND PROTECT CANADIAN AIRSPACE.....	10-MX20.01HO1-1
Appendix 2	SUPPORT INTERNATIONAL EVENTS HELD IN CANADA / RESPOND TO A MAJOR TERRORIST ATTACK.....	10-MX20.01HO2-1
Appendix 3	SUPPORT CIVILIAN AUTHORITIES.....	10-MX20.01HO3-1
Appendix 4	CONDUCT MAJOR INTERNATIONAL OPERATIONS / PROVIDE RAPID INTERNATIONAL DEPLOYMENT.....	10-MX20.01HO4-1
Annex P	CURRENT CANADIAN ARMED FORCES (CAF).....	10-MX20.01HP-1
Appendix 1	CANADIAN ARMED FORCES VIDEO STORYBOARD TEMPLATE.....	10-MX20.01HP1-1
Annex Q	CURRENT CANADIAN ARMED FORCES (CAF).....	10-MX20.01HQ-1
Appendix 1	PROVIDING ASSISTANCE ANYWHERE IN THE WORLD.....	10-MX20.01HQ1-1
Appendix 2	QUESTIONS.....	10-MX20.01HQ2-1
Appendix 3	Answer Sheet.....	10-MX20.01HQ3-1
Annex R	CANADIAN ARMED FORCES (CAF) CAREERS.....	10-MX20.01HR-1
Appendix 1	MATCHING CHALLENGE CARDS.....	10-MX20.01HR1-1
Annex S	LIFE IN THE ROYAL CANADIAN NAVY (RCN), ROYAL CANADIAN AIR FORCE (RCAF) OR CANADIAN ARMY.....	10-MX20.01HS-1
Section 9	EO CX20.01 – PARTICIPATE IN CAF FAMILIARIZATION ACTIVITIES..	10-CX20.01-1
CHAPTER 11	PO 121 – PARTICIPATE AS A MEMBER OF A TEAM DURING AN OVERNIGHT BIVOUAC FIELD TRAINING EXERCISE (FTX)	11-121-1/2
Section 1	EO M121.01 – SELECT PERSONAL EQUIPMENT.....	11-M121.01-1
Section 2	EO M121.02 – TRANSPORT PERSONAL EQUIPMENT.....	11-M121.02-1
Section 3	EO M121.03 – TIE KNOTS AND LASHINGS.....	11-M121.03-1
Attachment A	11-M121.03A-1
Attachment B	11-M121.03B-1
Section 4	EO M121.04 – ASSEMBLE A SURVIVAL KIT.....	11-M121.04-1
Attachment A	HANDOUT – EO M121.04 GLOSSARY.....	11-M121.04A-1
Attachment B	SURVIVAL KIT CONTENTS MATCHING ACTIVITY.....	11-M121.04B-1
Section 5	EO M121.05 – RECOGNIZE ENVIRONMENTAL HAZARDS.....	11-M121.05-1
Section 6	EO M121.06 – IDENTIFY ENVIRONMENTAL INJURIES.....	11-M121.06-1
Section 7	EO M121.07 – ERECT A GROUP TENT.....	11-M121.07-1

TABLE OF CONTENTS (Cont)

		PAGE
Section 8	EO M121.08 – APPLY “LEAVE NO TRACE” CAMPING.....	11-M121.08-1
Annex A	HANDOUT – THE PRINCIPLES OF LEAVE NO TRACE CAMPING.....	11-M121.08A-1
Section 9	EO M121.09 – FOLLOW CAMP ROUTINE.....	11-M121.09-1
Section 10	EO C121.01 – CONSTRUCT FIELD AMENITIES.....	11-C121.01-1
Attachment A	CONSTRUCT FIELD AMENITIES.....	11-C121.01A-1
Section 11	EO C121.02 – EXPLAIN THE EFFECTS OF COLD CLIMATE EXPOSURE.....	11-C121.02-1
Section 12	EO C121.03 – SELECT COLD WEATHER CLOTHING.....	11-C121.03-1
Section 13	EO C121.04 – RECOGNIZE THE EFFECTS OF COLD WEATHER.....	11-C121.04-1
Section 14	EO C121.05 – PARTICIPATE IN COLD WEATHER TRAINING.....	11-C121.05-1
CHAPTER 12	PO 122 – IDENTIFY LOCATION USING A MAP	12-122-1/2
Section 1	EO M122.01 – IDENTIFY TYPES OF MAPS.....	12-M122.01-1
Section 2	EO M122.02 – IDENTIFY MARGINAL INFORMATION AND CONVENTIONAL SIGNS.....	12-M122.02-1
Section 3	EO M122.03 – INTERPRET CONTOUR LINES.....	12-M122.03-1
Attachment A	INTERPRETING CONTOUR LINES.....	12-M122.03A-1
Section 4	EO M122.04 – ORIENT A MAP BY INSPECTION.....	12-M122.04-1
Section 5	EO M122.05 – DETERMINE A GRID REFERENCE.....	12-M122.05-1
Section 6	EO M122.06 – FOLLOW A ROUTE LED BY A SECTION COMMANDER.....	12-M122.06-1
Section 7	EO C122.01 – PRACTICE NAVIGATION AS A MEMBER OF A TEAM..	12-C122.01-1
CHAPTER 13	PO 123 – PARTICIPATE IN A DAY HIKE	13-123-1/2
Section 1	EO M123.01 – SELECT HIKING CLOTHING AND EQUIPMENT.....	13-M123.01-1
Section 2	EO M123.02 – PARTICIPATE IN A DAY HIKE.....	13-M123.02-1
Section 3	EO C123.01 – PARTICIPATE IN ADVENTURE TRAINING.....	13-C123.01-1
Section 4	EO C123.02 – EXPLAIN SNOWSHOE MARCH DISCIPLINE.....	13-C123.02-1
Section 5	EO C123.03 – PARTICIPATE IN A SNOWSHOEING HIKE.....	13-C123.03-1

CHAPTER 1

PO X01 – PARTICIPATE IN CITIZENSHIP ACTIVITIES



**COMMON TRAINING
ALL TRAINING LEVELS
INSTRUCTIONAL GUIDE
CITIZENSHIP**



SECTION 1

EO MX01.01A – PARTICIPATE IN A CITIZENSHIP TOUR

Total Time:

One session (3 periods) = 90 min

**THERE IS NO INSTRUCTIONAL GUIDE PROVIDED FOR THIS EO. REFER TO
THE LESSON SPECIFICATION LOCATED IN A-CR-CCP-701/PG-001, ROYAL
CANADIAN ARMY CADETS GREEN STAR QUALIFICATION STANDARD AND PLAN.**

THIS PAGE INTENTIONALLY LEFT BLANK



**COMMON TRAINING
ALL TRAINING LEVELS
INSTRUCTIONAL GUIDE
CITIZENSHIP**



SECTION 2

EO MX01.01B – ATTEND A PRESENTATION BY A COMMUNITY ORGANIZATION

Total Time:

One session (3 periods) = 90 min

**THERE IS NO INSTRUCTIONAL GUIDE PROVIDED FOR THIS EO. REFER TO
THE LESSON SPECIFICATION LOCATED IN A-CR-CCP-701/PG-001, ROYAL
CANADIAN ARMY CADETS GREEN STAR QUALIFICATION STANDARD AND PLAN.**

THIS PAGE INTENTIONALLY LEFT BLANK



**COMMON TRAINING
ALL TRAINING LEVELS
INSTRUCTIONAL GUIDE
CITIZENSHIP**



SECTION 3

EO MX01.01C – ATTEND A PRESENTATION BY A CITIZEN-OF-INTEREST

Total Time:

One session (3 periods) = 90 min

**THERE IS NO INSTRUCTIONAL GUIDE PROVIDED FOR THIS EO. REFER TO
THE LESSON SPECIFICATION LOCATED IN A-CR-CCP-701/PG-001, ROYAL
CANADIAN ARMY CADETS GREEN STAR QUALIFICATION STANDARD AND PLAN.**

THIS PAGE INTENTIONALLY LEFT BLANK



**COMMON TRAINING
ALL TRAINING LEVELS
INSTRUCTIONAL GUIDE
CITIZENSHIP**



SECTION 4

EO MX01.01D – PARTICIPATE IN THE CANADIAN CITIZENSHIP CHALLENGE

Total Time:

One session (3 periods) = 90 min

**THERE IS NO INSTRUCTIONAL GUIDE PROVIDED FOR THIS EO. REFER TO
THE LESSON SPECIFICATION LOCATED IN A-CR-CCP-701/PG-001, ROYAL
CANADIAN ARMY CADETS GREEN STAR QUALIFICATION STANDARD AND PLAN.**

THIS PAGE INTENTIONALLY LEFT BLANK



**COMMON TRAINING
ALL TRAINING LEVELS
INSTRUCTIONAL GUIDE
CITIZENSHIP**



SECTION 5

EO MX01.01E – HOST A CITIZENSHIP CEREMONY

Total Time:

One session (3 periods) = 90 min

**THERE IS NO INSTRUCTIONAL GUIDE PROVIDED FOR THIS EO. REFER TO
THE LESSON SPECIFICATION LOCATED IN A-CR-CCP-701/PG-001, ROYAL
CANADIAN ARMY CADETS GREEN STAR QUALIFICATION STANDARD AND PLAN.**

THIS PAGE INTENTIONALLY LEFT BLANK



**COMMON TRAINING
ALL TRAINING LEVELS
INSTRUCTIONAL GUIDE**



SECTION 6

EO MX01.01F – PARTICIPATE IN AN ELECTION

Total Time:

One session = 90 min

PREPARATION

PRE-LESSON INSTRUCTIONS

This IG supports EO MX01.01F (Participate in an Election) located in A-CR-CCP-701/PG-001, *Royal Canadian Army Cadets Green Star Qualification Standard and Plan*, Chapter 4.

In coordination with the appropriate authority, select a decision or appointment to be made democratically by the corps / squadron, such as the inventory of the canteen, the cadet representative to the officer cadre, or the destination for a year-end trip.

Complete a process with the appropriate authority to select up to four candidates for the election or up to four options for the referendum (unless it is a yes / no question). Referendum options selected should have wide support throughout the corps / squadron, ensuring that campaign teams are equally motivated and that cadets must decide between compelling options.

Arrange for and brief two assistant instructors to conduct simultaneous activities with groups of cadets.

Prepare the required resources:

- materials required for the roles and processes described in the Guide for Election Officials located at Annex B for each polling station (one station per 20 cadets), to include:
 - two copies of the Guide for Election Officials located at Annex B,
 - one box with a slot or opening in the top, to act as a ballot box,
 - sufficient tape to seal the ballot box,
 - one presentation board, or cut open box, to act as a voting screen,
 - two pencils,
 - one ruler,
 - one 8.5" by 11" envelope, marked "Spoiled Ballots," and
 - materials located at Annex C (Referendum) or Annex D (Election), to include:
 - 23 ballots,
 - one copy of the Official Statement of the Vote form,
 - one copy of the Tally Sheet;

- flipchart paper or other method of displaying the reflection questions included in Annex A;
- materials for creating campaign items, including flipchart paper, markers, and flagging tape; and
- a nominal roll of all cadets to act as the list of electors.

To make a more realistic simulation, resources, such as a ballot box, voting screen, and seals, may be ordered from Elections Canada (elections.ca) at 1-800-463-6868.

PRE-LESSON ASSIGNMENT

Nil.

APPROACH

A practical activity was chosen for this lesson as a fun and interactive way to build on the cadets' knowledge of citizenship.

INTRODUCTION

REVIEW

Nil.

OBJECTIVES

By the end of this session the cadets shall have participated in a democratic process.

IMPORTANCE

It is important for cadets to participate in an election as part of being a good citizen is having an appreciation for and awareness of the democratic process.

ACTIVITY

1. Divide the cadets into three groups. Phase One / Green Star / Proficiency Level One and Phase Two / Red Star / Proficiency Level Two cadets will form "the electorate," Phase Three / Silver Star / Proficiency Level Three cadets will form "the campaigners," and Phase Four / Gold Star / Proficiency Level Four cadets will form "the election officials." A ratio of 15 cadets per three campaigners and per two election officials is ideal.



The grouping of cadets may be modified to meet individual corps / squadron requirements. For example, cadets may be moved between groups, despite their phase / star / proficiency level, to meet the 15 : 3 : 2 ratio. If there are not enough cadets to form all three groups, adult staff may be used to fill the role of campaigners.

2. Conduct the election as per the Election Instructions located at Annex A.



In this election, the instructor will be filling the role of Returning Officer, the official in charge of ensuring the election is carried out properly and providing materials.

CONCLUSION

METHOD OF EVALUATION

Nil.

CLOSING STATEMENT

It is important for cadets to participate in an election, as part of being a good citizen is having an appreciation for and awareness of the democratic process.

INSTRUCTOR NOTES / REMARKS

There are numerous potential leadership opportunities for cadets when conducting an election session, such as:

- Phase Three / Silver Star / Proficiency Level Three, Phase Four / Gold Star / Proficiency Level Four, and Phase Five / Master Cadet / Proficiency Level Five cadets may complete leadership assignments, such as leading a campaign team, in accordance with POs 303 (Perform the Role of a Team Leader), 403 (Act as a Team Leader), and 503 (Lead Cadet Activities); and
- Phase Five / Master Cadet / Proficiency Level Five cadets may plan, prepare and conduct the session as a leadership project in accordance with PO 503 (Lead Cadet Activities).

Two assistant instructors are required for this lesson.

REFERENCES

Elections Canada. (2010). *Canada at the Polls!* Retrieved March 13, 2013, from <http://elections.ca/content.aspx?section=vot&dir=yth/stu/gui&document=index&lang=e>.

THIS PAGE INTENTIONALLY LEFT BLANK

ELECTION INSTRUCTIONS

STEP 1: PREPARATION		TIME: 25 MIN
ELECTORATE (YEARS 1 & 2)	CAMPAIGNERS (YEAR 3)	ELECTION OFFICIALS (YEAR 4)
<p>Conduct an activity to stimulate an interest in democratic decision making, such as participating in:</p> <ul style="list-style-type: none"> • a presentation by a guest speaker as per MX01.01B (Attend a presentation by a Community Organization) or MX01.01C (Attend a Presentation by a Citizen-of-Interest), such as an Elections Canada official, a former political candidate, or a former campaign worker; • related Heritage Minutes video activities as per EO MX01.01G (Participate in Heritage Minutes Video Activities), such as <i>Nellie McClung</i>, <i>Responsible Government</i> or <i>Baldwin & LaFontaine</i>; and • relevant learning stations as per EO MX01.01H (Participate in Citizenship Learning Stations). 	<p>Prepare the campaigners to present their positions to the corps / squadron by:</p> <ol style="list-style-type: none"> 1. forming one campaign team per candidate and assigning candidates to those teams if an election is being conducted, forming two teams and assigning “yes” and “no” positions if a referendum is to be conducted on a yes / no question, allowing the cadets to form teams for their desired option if a referendum is to be conducted on an open-ended question; 2. having the teams form a platform, including details on their option or candidate and points on why the candidate or option is the most desirable; and 3. having the teams plan a campaign, including a presentation to the electorate. 	<p>Prepare the election officials to fill their role, by:</p> <ol style="list-style-type: none"> 1. grouping the cadets into teams of two, one cadet filling the role of Deputy Returning Officer and the other Poll Clerk; 2. reviewing the roles and administering the oaths of office as per the Guide for Election Officials located at Annex B; 3. reviewing the importance for strict impartiality by election officials — while they may have a position on the election / referendum, they must appear to be completely neutral (eg, they may not discuss the election / referendum, support a candidate or campaign, or otherwise allow for their preference to be known) — thereby helping to ensure that electors and campaigners have faith in the process and outcome; 4. assigning a portion of the corps / squadron to each station by name (eg, A–H at Polling Station 1, I–M at Polling Station 2, etc.), providing the appropriate nominal roll to each station, and labeling the ballot box appropriately, if there is a need for more than one polling station; and 5. having the cadets begin to set up polling stations as per the Guide for Election Officials located at Annex B.

STEP 2: CAMPAIGN		TIME: 20 MIN
ELECTORATE (YEARS 1 & 2)	CAMPAIGNERS (YEAR 3)	ELECTION OFFICIALS (YEAR 4)
<p>Have the campaign teams present their platforms to the corps / squadron, allowing equal time for each. Campaign teams may also distribute materials or methods of identifying their supporters, such as coloured flagging tape or signs.</p> <p>Election officials will observe the campaign activities, but, as discussed above, may not participate nor show support for any campaign.</p>		
STEP 3: VOTE		TIME: 15 MIN
ELECTORATE (YEARS 1 & 2)	CAMPAIGNERS (YEAR 3)	ELECTION OFFICIALS (YEAR 4)
<p>Have the cadets filling the role of election officials administer the polling station for the corps / squadron as per the Guide for Election Officials located at Annex B. Have the election officials vote just before opening the polling station to the corps / squadron.</p> <p>One representative from each campaign may act as a scrutineer after taking the required oath (administered by the Deputy Returning Officer as per the handout located at Annex B) by observing the administration of a polling station. Campaigners may also continue to lobby cadets not attending the polling station.</p>		

STEP 4: TABULATION AND REFLECTION		TIME: 15 MIN
ELECTORATE (YEARS 1 & 2)	CAMPAIGNERS (YEAR 3)	ELECTION OFFICIALS (YEAR 4)
<p>Prompt reflection on the process by posing the following questions to the group to bring about understanding of the variety of decision-making processes used by citizens during elections and of the importance of the secret ballot to fair elections:</p> <p>Q1. What did you base your decision on?</p> <p>Q2. What role did the campaigns play in your decision?</p> <p>Q3. How did you find the voting process?</p> <p>Q4. At one time, citizens voted by standing up in front of a big crowd and announcing who they were voting for. How might this have affected how people voted?</p>	<p>Conduct a group discussion to draw awareness to the following points:</p> <ul style="list-style-type: none"> • campaign teams must present a united front, even if that means hiding their individual beliefs; • creating a platform requires compromise and is a blend of different beliefs; and • joining a campaign can be an interesting way to get involved in an election. <p>Suggested Questions:</p> <p>Q1. What did you learn from the campaign process?</p> <p>Q2. Did you find it difficult to reach a collective platform?</p> <p>Q3. In supporting the campaign team, did you find that you ever had to express support for a position that you, personally, did not support? How did you feel about that?</p> <p>Q4. Do you plan to get involved in a campaign during the next election / referendum? Why or why not?</p>	<p>Tabulate the ballots as per the Guide for Election Officials located at Annex B;</p>

STEP 5: RESULTS, DE-BRIEF, AND REFLECTION		TIME: 10 MIN
ELECTORATE (YEARS 1 & 2)	CAMPAIGNERS (YEAR 3)	ELECTION OFFICIALS (YEAR 4)
Announce the results and declare the candidate / option with the plurality (greatest number) of votes selected.		
<p>Complete the following steps to debrief the cadets and link the election to Canadian elections:</p> <ol style="list-style-type: none"> 1. provide time for the campaign team with a plurality to thank the electorate and the other campaign teams, 2. explain that this process is similar to that which is conducted to elect members of parliament, 3. identify the riding(s) relevant to the corps / squadron and the respective member(s) of parliament, and 4. note that all Canadian citizens age 18 or over may participate in those elections. 		<p>Conduct a discussion to bring out the following points:</p> <ol style="list-style-type: none"> 1. election officials, like public servants more generally, must give up some of their rights in order to maintain the impartiality of democratic processes; and 2. election officials play a key role in ensuring the fairness of elections by following a set of clear procedures that allow for results to be verified and trusted. <p>Suggested Questions:</p> <p>Q1. What did you observe about the election process?</p> <p>Q2. How did you feel about remaining impartial throughout the election?</p> <p>Q3. Would you be interested in performing this role again? Why or why not?</p>

GUIDE FOR ELECTION OFFICIALS

OATH OF OFFICE

This oath will be administered by the Returning Officer to the DRO and PC before they begin performing their duties.

I solemnly affirm that:

- *I am a member of _____ (give the name of the corps / squadron);*
- *I will act faithfully without partiality, fear, favour or affection and in every respect according to the law;*
- *at the polling station, I will maintain the secrecy of the vote.*

ROLE DESCRIPTION AND CHECKLIST FOR THE DEPUTY RETURNING OFFICER

Take the required oath as per the note box above.

Prepare the Polling Station

With the Poll Clerk, the Deputy Returning Officer shall:

set up the polling station with the necessary materials as per Figure A-1;

count the ballots provided by the Returning Officer;

enter the number of ballots provided into the appropriate place on the Official Record of the Vote; and

place their initials on the back of all ballots.

LAYOUT OF A POLLING STATION

Figure A-1 demonstrates a suggested layout for a polling station. The table for the campaign representatives is not required. If supplies permit, all material may be placed on a single table.

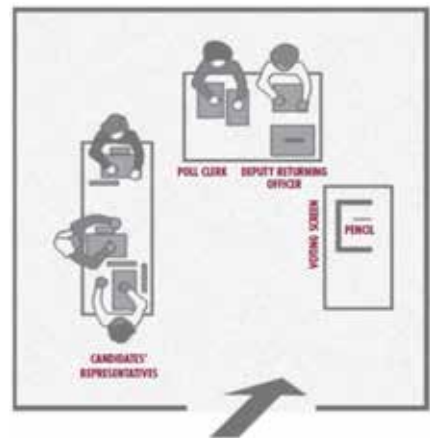

Figure A-1 Layout of a Polling Station

Administer the Voting Process

To open the polling station, the DRO shall:

Administer the following oath to campaign representatives: *I solemnly affirm that: I will maintain the secrecy of the vote; I will not interfere with the marking of a ballot by any voter nor ask any voter how they are about to vote or have voted; and I will not induce a voter to show a marked ballot to any person; and*

show all present that the ballot box is empty and seal it.

When an elector comes to vote, the DRO shall:

ensure the DRO's initials are placed on the ballot paper, fold it twice as per Figure A-2, and present it to the elector with instructions to: go behind the voting screen, mark the circle opposite their choice (or, if using a write-in ballot, write their choice in the space provided), and return it folded the same way;

check that the DRO's initials are on the ballot returned by the elector and return it to the elector with instructions to place it in the ballot box;

if an elector indicates they have made a mistake, receive the spoiled ballot, place it in the envelope of spoiled ballots, and issue a new ballot to the elector;

if an elector requires assistance to vote, provide assistance in such a way that the privacy of the vote is maintained (eg, instead of asking "who would you like to vote for?" ask the voter to point or write down the name of the person) and that it is done within full view of the Poll Clerk; and

after voting, make sure the poll clerk places "V," for voted, next to the elector's name on the voters' list.



Figure A-2 Folding a Ballot

Count the Votes

After voting is completed, counting of the ballots will commence. Only the DRO may handle ballots. The DRO shall:

empty the contents of the ballot box onto the table;

one by one, check each ballot for their initials, unfold, call out the name of the candidate or option that has been marked, and show the ballot to the candidates' representatives and to the poll clerk, who records the votes on a tally sheet;

if a ballot does not clearly reflect a voter's intention or includes identifying information (eg, name or initials), declare that ballot rejected;

place the ballots in piles, one for each candidate or option, with separate piles for rejected or spoiled ballots; and

once counting is completed, complete the official statement of the vote.

ACCEPTABLE BALLOTS	UNACCEPTABLE (REJECTED) BALLOTS
Ballots marked with cross (X) or other symbol	Ballots not supplied by the Deputy Returning Officer (initials not present on back)
Ballots marked with a pencil or pen different than which was provided	Ballots not marked
Ballots where the mark leaves the circle	Ballots with a mark in the circle for more than one candidate (including if candidates appear to be ranked)
Ballots where the circle has been completely, or partially, shaded in	Ballots marked or written on by an elector in such a way that the elector could be identified
For write-in ballots, ballots with only part of the option as long as it is possible to determine the intended option	Ballots not marked in any of the circles

ROLE DESCRIPTION AND CHECKLIST FOR THE POLL CLERK

Take the required oath as per the note box above.

Open the Polling Station

The Poll Clerk (PC) shall assist the DRO in setting up the polling station as per above.

Administer the Voting Process

After assisting the DRO in opening the polling station, the PC will process electors. When an elector comes to vote, the PC shall:

have the elector state their name and division / platoon / flight;

locate the elector’s name on the list and draw a line through the entry; and

once the elector has exercised their right to vote, place a V for “voted” next to the elector’s name on the list.

Count the Votes

After voting has concluded, the PC shall:

keep a tally of the votes cast as the DRO calls out the candidate or option selected using the tally sheet;

report the total votes cast to the DRO; and

assist the DRO in completing the Official Record of the Vote.

THIS PAGE INTENTIONALLY LEFT BLANK

MATERIALS FOR A REFERENDUM

If you are conducting an election, to select a candidate for a position, see the materials at Annex D.

Ballot for a Referendum with a “Yes” or “No” Question

		YES	<input type="radio"/>
		NO	<input type="radio"/>
		YES	<input type="radio"/>
		NO	<input type="radio"/>
		YES	<input type="radio"/>
		NO	<input type="radio"/>
		YES	<input type="radio"/>
		NO	<input type="radio"/>
		YES	<input type="radio"/>
		NO	<input type="radio"/>

Ballot for a Referendum with Options

Before reproducing the ballots, cut out the ballot, write in the question and options, and, if necessary, cut to modify the ballot for two or three options.



Referendum Tally Sheet

	OPTION					OPTION					OPTION					OPTION					
5																					5
10																					10
15																					15
20																					20
25																					25
30																					30
35																					35
40																					40
45																					45
50																					50
55																					55
60																					60
65																					65
70																					70
75																					75
80																					80
85																					85
90																					90
95																					95
100																					100
105																					105
110																					110
115																					115

Official Statement of the Referendum Vote

Polling Station: _____ Date: _____
(Name or number)

OPTIONS (same order as on ballot)	NUMBER OF VOTES

VALID VOTES CAST	_____	SPOILED BALLOTS	_____
REJECTED BALLOTS	+ _____	UNUSED BALLOTS	+ _____
TOTAL VOTES CAST	= _____	TOTAL BALLOTS NOT USED TO VOTE	= _____

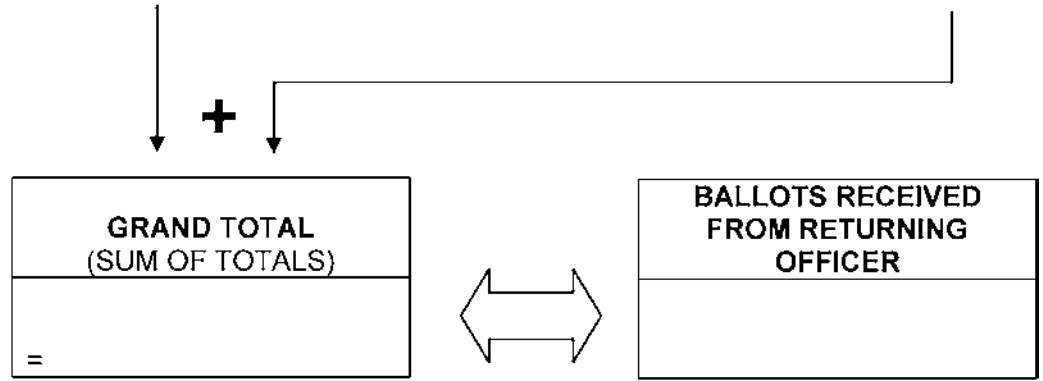

GRAND TOTAL OF THE COUNT MUST EQUAL THE NUMBER OF
BALLOTS RECEIVED FROM THE RETURNING OFFICER

Signature of Deputy Returning Officer

Signature of Poll Clerk

Signature of Campaign Representative

Signature of Campaign Representative

Signature of Campaign Representative

Signature of Campaign Representative

THIS PAGE INTENTIONALLY LEFT BLANK

MATERIALS FOR AN ELECTION

Ballot for an Election

Before reproducing, cut out the ballot, write in the candidate names, and, if necessary, cut to modify the ballot for two or three options.

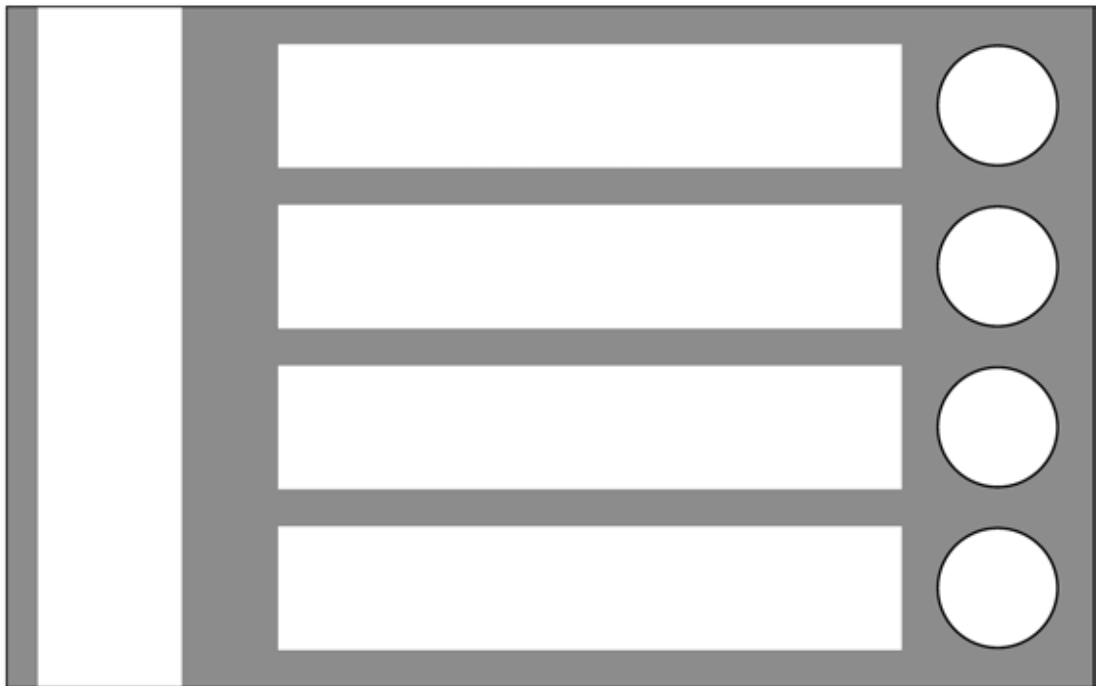
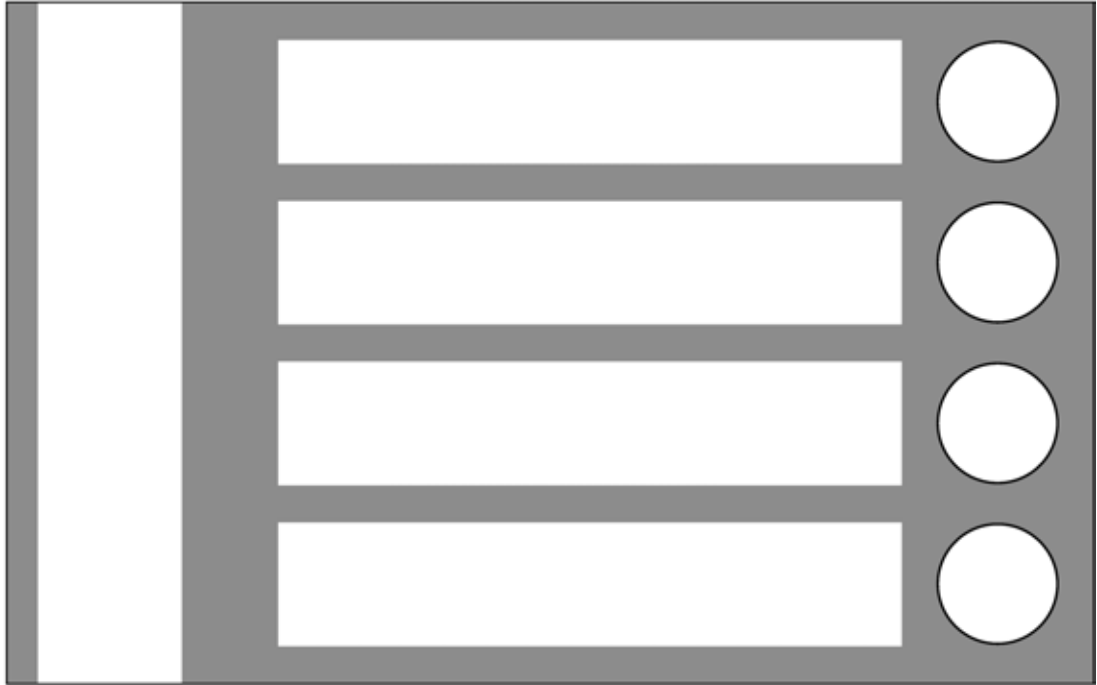

Write-in Ballot for an Election

If time does not permit for sufficient ballots to be prepared a write-in ballot may be used. Post a list of options at the polling station and on the back of the voting screen and provide the ballot below to electors.

	<p>I vote for _____ Name and surname (or initials) of candidate of your choice.</p>
--	---

	<p>I vote for _____ Name and surname (or initials) of candidate of your choice.</p>
--	---

	<p>I vote for _____ Name and surname (or initials) of candidate of your choice.</p>
--	---

	<p>I vote for _____ Name and surname (or initials) of candidate of your choice.</p>
--	---

	<p>I vote for _____ Name and surname (or initials) of candidate of your choice.</p>
--	---

Election Tally Sheet

	CANDIDATE					CANDIDATE					CANDIDATE					CANDIDATE					
5																					5
10																					10
15																					15
20																					20
25																					25
30																					30
35																					35
40																					40
45																					45
50																					50
55																					55
60																					60
65																					65
70																					70
75																					75
80																					80
85																					85
90																					90
95																					95
100																					100
105																					105
110																					110
115																					115

Official Statement of the Election Vote

Polling Station: _____ Date: _____
 (Name or number)

CANDIDATES (same order as on ballot)	NUMBER OF VOTES

VALID VOTES CAST _____	SPOILED BALLOTS _____
REJECTED BALLOTS + _____	UNUSED BALLOTS + _____
TOTAL VOTES CAST = _____	TOTAL BALLOTS NOT USED TO VOTE = _____

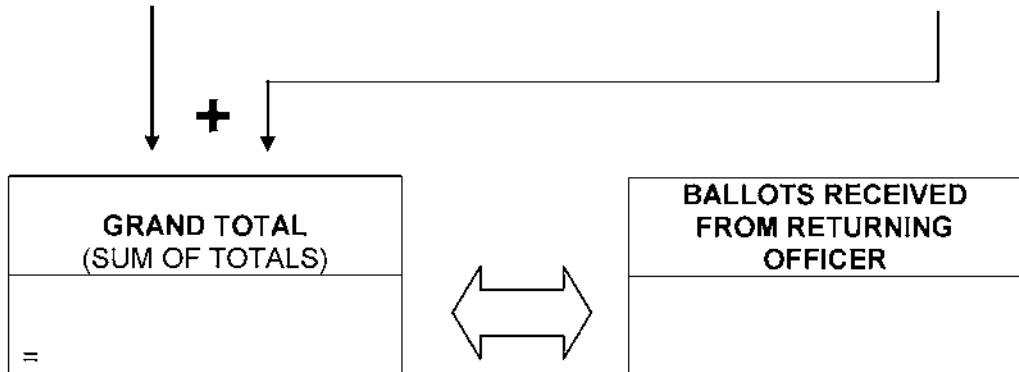

GRAND TOTAL OF THE COUNT MUST EQUAL THE NUMBER OF
 BALLOTS RECEIVED FROM THE RETURNING OFFICER

Signature of Deputy Returning Officer

Signature of Campaign Representative

Signature of Campaign Representative

Signature of Poll Clerk

Signature of Campaign Representative

Signature of Campaign Representative



**COMMON TRAINING
ALL TRAINING LEVELS
INSTRUCTIONAL GUIDE**



SECTION 7

EO MX01.01G – PARTICIPATE IN HERITAGE MINUTES VIDEO ACTIVITIES

Total Time:

One session = 90 min

PREPARATION

PRE-LESSON INSTRUCTIONS

This IG supports EO MX01.01G (Participate in Heritage Minutes Video Activities) located in A-CR-CCP-701/PG-001, *Royal Canadian Army Cadets Green Star Qualification Standard and Plan*, Chapter 4.

Select Heritage Minutes videos, and plan and prepare activities.

Heritage Minutes videos can be viewed on the Internet or purchased on DVD at www.historica-dominion.ca > VIDEO > HERITAGE MINUTES.

Example videos and accompanying activities are located at Annexes A–G.

In addition to the suggested Heritage Minutes video activities attached, activity leaders may choose their own Heritage Minutes videos and create their own interactive, challenging and fun activities. The suggested activities may be adapted as required.

For certain Heritage Minutes, the Historica-Dominion Institute provides activities that may be used by the activity leader. For example: www.historica-dominion.ca > VIDEO > HERITAGE MINUTES > BLUENOSE > LEARNING RESOURCES includes classroom tools for intermediate (Cadet Program Years 1 and 2) and secondary (Cadet Program Years 3 and 4).

Gather background information on the content of the selected videos so you are prepared to provide context to the cadets and answer any of their questions. Background information is available at www.historica-dominion.ca > VIDEO > HERITAGE MINUTES.

Gather the required resources:

- method to display the video (eg, television, DVD player, tablet, laptop),
- videos, and
- any other resources required as per selected activity.

PRE-LESSON ASSIGNMENT

Nil.

APPROACH

An in-class activity was chosen for this lesson as it is a fun and interactive way to build on the cadets' knowledge of citizenship.

INTRODUCTION

REVIEW

Nil.

OBJECTIVES

By the end of this session the cadets shall have participated in Heritage Minutes video activities.

IMPORTANCE

It is important for cadets to participate in Heritage Minutes video activities as part of being a good citizen is having an appreciation for Canadian historical figures and significant events.

ACTIVITY

1. Play the selected video or series of videos with a similar theme.
2. Conduct an activity in which the cadet will further explore the topic introduced in the video(s).

CONCLUSION

METHOD OF EVALUATION

Nil.

CLOSING STATEMENT

It is important for cadets to participate in Heritage Minutes video activities as part of being a good citizen and having an appreciation for Canadian historical figures and significant events.

INSTRUCTOR NOTES / REMARKS

There are numerous potential leadership opportunities for cadets when conducting a Heritage Minutes video activities session:

- Phase Five / Master Cadet / Proficiency Level Five cadets may plan, prepare and conduct the session as a leadership project IAW PO 503 (Lead Cadet Activities); and
- Phase Three / Silver Star / Proficiency Level Three, Phase Four / Gold Star / Proficiency Level Four, and Phase Five / Master Cadet / Proficiency Levels Five cadets may complete leadership assignments, such as leading a Heritage Minutes video activity, IAW POs 303 (Perform the Role of a Team Leader), 403 (Act as a Team Leader), and 503 (Lead Cadet Activities).

REFERENCES

Historica Dominion Institute. *Heritage Minutes Videos*. Retrieved March 15, 2013, from <https://www.historica-dominion.ca/content/video>.

SUGGESTED HERITAGE MINUTES VIDEO ACTIVITIES: GENERAL

GENERAL INTRODUCTORY ACTIVITIES

Brainstorm. As a large group or in smaller groups, have the cadets list what they know about the video topic (eg, inukshuk). If the video topic is not well-known, prepare questions that may help stimulate the cadets' thinking (eg, Who first used inukshuk? Where are the Inuit from? Which territory's flag shows an inukshuk? What were inukshuk used for?). If conducted as a large group, write down key words in a thought web as the cadets brainstorm.

Think – Pair – Share. Have the cadets individually think about and list what they know about the video topic (eg, Winnie the Pooh). Have the cadets share what they know about the video topic with a partner. Invite the cadets to share what they learned from their partner with the larger group.

KWL Chart. Have the cadets complete a chart with three columns:

- what they **K**now about the video topic (eg, maple syrup),
- what they **W**ant to know about the video topic, and
- what they have **L**earned about the video topic (to be completed after watching the video as part of the follow-up activity).

GENERAL FOLLOW-UP ACTIVITIES

Highlights. Have the cadets individually list the three most interesting or surprising things they learned from watching the video. Have the cadets share and discuss these highlights with a partner or in small groups. If time permits, invite cadets to share highlights with the larger group.

Cadets' Questions. Have the cadets write a question they have after watching the video. In other words, what more would they like to learn about this topic? Answer the cadets' questions or challenge them to find out the answer to their own question prior to the next session.

Activity Leader's Questions. Have the cadets respond to thought-provoking questions about the video topic. For example, if the video topic is the Avro Arrow, questions could include: What do you think the government's primary reasons were for cancelling the Arrow program? Do you agree / disagree with Prime Minister Diefenbaker's decision to cancel the Arrow program? What other technologies are recognized as being Canadian in origin, or associated with Canada?

Learning Stations. The video may be a short introductory video to stimulate the cadets' interests as part of a more comprehensive activity, such as learning stations. For more guidance on how to conduct learning stations refer to EO MX01.01G (Participate in Citizenship Learning Stations).

THIS PAGE INTENTIONALLY LEFT BLANK

SUGGESTED ACTIVITY: *FLAGS* VIDEO

ACTIVITY: CREATE YOUR OWN FLAG

TIME: 30 min

TRAINING LEVEL: 1–2

PRE-ACTIVITY INSTRUCTIONS:

Gather the required resources:

- Flag template located at Appendix 1,
- Pens / pencils, and
- Markers / coloured pencils.

ACTIVITY INSTRUCTIONS:

1. Show the cadets the *Flags* Heritage Minutes video.
2. Divide the cadets into teams of three or four.
3. Distribute copies of the “Design Your Own Flag” template located at Appendix 1 and markers / coloured pencils to each team.
4. Have each team choose whether their flag will represent their municipality, province or country.
5. Give the teams 15 min to create their own flag. Tell the cadets the design and colour of the flags must reflect team consensus.
6. Give each team 2–3 min to present their flag, describe its features and explain their design choice to the rest of the teams. If there are four or more teams, pair them and have the cadets present their flag to another team.
7. Give the cadets 5 min to reflect / discuss the challenges of forming a consensus. Suggested questions for discussion include:
 - (a) What was the process your team used to reach a consensus?
 - (b) How easy / difficult was it for your team to reach a consensus regarding the design / creation of your flag?
 - (c) In the end, did all of the team members agree?
8. Display the flags at the corps / squadron for all to enjoy.

THIS PAGE INTENTIONALLY LEFT BLANK

DESIGN YOUR OWN FLAG

Use the template below to create your own flag. Your flag should reflect group consensus and can represent a nation, province or municipality.



THIS PAGE INTENTIONALLY LEFT BLANK

SUGGESTED ACTIVITIES: *SAM STEELE* VIDEO

ACTIVITY: "I WANT TO BE A CANADIAN"

TIME: 15 min

TRAINING LEVEL: 1–4

PRE-ACTIVITY INSTRUCTIONS:

Gather the required resources:

- Flipchart paper,
- Pens / pencils, and
- Markers.

ACTIVITY INSTRUCTIONS:

1. Show the cadets the *Sam Steele* Heritage Minutes video.
2. Divide the cadets into teams of three or four.
3. Distribute flipchart paper, pens / pencils and markers to each team.
4. Give the teams 5 min to brainstorm and compile a list of characteristics and attributes that they feel exemplify the Canadian spirit.
5. Give each team 2–3 min to present and explain their list to the other groups.
6. After all of the teams have presented, have the cadets compare the lists to identify common characteristics and compile a master list.
7. Display the master list for the rest of the corps / squadron to see.

SUGGESTED ACTIVITIES: *SAM STEELE* VIDEO

ACTIVITY: ENTRANCE TO CANADA EXAM

TIME: 15 min

TRAINING LEVEL: 1–4

PRE-ACTIVITY INSTRUCTIONS:

Gather the required resources:

- Entrance to Canada Exam located at Appendix 1, and
- Pens / pencils.

ACTIVITY INSTRUCTIONS:

1. Show the cadets the *Sam Steele* Heritage Minutes video.
2. In this role-play, the instructor will play “Sam Steele” and the cadets will play groups of people attempting to get into Canada.
3. Divide the cadets into teams of three or four to answer the questions in a role-play.
4. Have the cadets take the “Entrance to Canada Exam” administered by Sam Steele and answer ten of the questions correctly in order to “gain entry into Canada.”
5. Alternatively, have the cadets complete the written exam individually and hand them in to be marked by “Sam Steele.”



You may portray “Sam Steele” as a role-play in a realistic fashion, which could include wearing a Mountie uniform.

ENTRANCE TO CANADA EXAM

Congratulations! You have just arrived at the US – Canada border. In order to gain entrance, you must correctly answer 10 of the questions below:

- Q1. Canada is made up of five distinct regions. Name three of them.**
A. Atlantic, Central, Prairie, West Coast, Northern.
- Q2. What are the two official sports of Canada?**
A. Hockey and lacrosse.
- Q3. What is Canada's motto?**
A. English - From sea to sea, French - D'un océan à l'autre, Latin - A Mari Usque Ad Mare.
- Q4. Does Canada hold sovereignty over the North Pole?**
A. No.
- Q5. What is the floral emblem of Canada?**
A. Maple leaf.
- Q6. What is the national animal of Canada?**
A. The beaver.
- Q7. The Canadian Coat of Arms has two animals holding up the shield. What are the two animals?**
A. A lion and a unicorn.
- Q8. What are the three orders of government in Canada?**
A. Federal, provincial / territorial, and municipal.
- Q9. Who is Canada's Head of State?**
A. The Monarch.
- Q10. What is Canada's system of government called?**
A. Parliamentary democracy and constitutional monarchy.
- Q11. How are members of Parliament chosen?**
A. Elected by Canadian citizens.
- Q12. Name six responsibilities of citizenship.**
A. Vote, help others, care for our heritage and environment, obey Canada's laws, respect the rights of others, and eliminate injustice.
- Q13. How is the Prime Minister chosen?**
A. The leader of the party with the most elected representatives becomes the Prime Minister.
- Q14. What are the three main groups of Aboriginal peoples?**
A. First Nations, Métis and Inuit.

Q15. What are the two official languages of Canada?

A. French and English.

Q16. What do you call the Sovereign's representative in the provinces?

A. Lieutenant-Governor.

Q17. What does confederation mean?

A. Joining of provinces to make a new country.

Q18. What does it mean to say Canada is a constitutional monarchy?

A. Canada's Head of State is a hereditary sovereign (Queen or King) who reigns in accordance with the constitution.

Q19. What is the meaning of the Remembrance Day poppy?

A. To remember the sacrifice of Canadians who have served or died in wars up to the present day.

Q20. When is Canada Day and what does it celebrate?

A. The anniversary of Confederation - July 1st of each year.

SUGGESTED ACTIVITY: *NELLIE MCCLUNG* VIDEO

ACTIVITY: THE RIGHT TO VOTE

TIME: 30 min

TRAINING LEVEL: 1–2

PRE-ACTIVITY INSTRUCTIONS:

Gather the required resources:

- Flipchart paper,
- Pens / pencils, and
- Markers.

ACTIVITY INSTRUCTIONS:

1. Show the cadets the *Nellie McClung* Heritage Minutes video.
2. Divide the cadets into teams of three or four.
3. Distribute flipchart paper and markers to each group.
4. Give the teams 10 min to brainstorm and compile a list of reasons why it is important for all Canadian citizens to have the right to vote.
5. Give each team 2–3 min to present and justify their list to the rest of the teams.
6. After all of the teams have presented, have the cadets compare the lists to identify common reasons and compile a master list.
7. Give the cadets 5 min to discuss other voting issues. Suggested questions for discussion can include:
 - (a) Should a Canadian citizen ever lose the right to vote?
 - (b) Should prisoners be allowed to vote?
8. Display the master list for the corps / squadron to see.

THIS PAGE INTENTIONALLY LEFT BLANK

SUGGESTED ACTIVITIES: AVRO ARROW VIDEO

ACTIVITY: "CANADIAN OR NOT" GAME

TIME: 30 min

TRAINING LEVEL: 1–4

PRE-ACTIVITY INSTRUCTIONS:

- Gather the required resources:
 - "Canadian or NOT" flashcards at Appendix 1 (1 set per team),
 - Flipchart paper,
 - Pens / pencils, and
 - Markers.
- Photocopy the "Canadian or NOT" flashcards and cut them into individual cards.



Powerpoint slides can also be created to represent the flashcards. Feel free to create additional cards.

ACTIVITY INSTRUCTIONS :







1. Show the cadets the *Avro Arrow* Heritage Minutes video.
2. Divide the cadets into teams of three or four.
3. Select 15 items from the Canadian list and 10 items from the "Not" list to create flashcards or slideshow questions.
4. Show the cadets flashcards with the name / picture of either a Canadian invention or foreign invention.
5. Allow the teams time to discuss briefly and decide if the invention being displayed is "Canadian or NOT." Have an instructor / cadet keep score.
6. Repeat Steps 4 and 5 until all 25 flashcards have been seen by the cadets.
7. Declare the team with the most points at the end of the 25 cards the "Great Canadian Know-it-Alls."

THIS PAGE INTENTIONALLY LEFT BLANK



CANADIAN OR NOT?

Select 15 items from the Canadian list and 10 items from the “Not” list to create flashcards or slideshow questions. Feel free to add your own items.

CANADIAN	NOT
<p data-bbox="224 506 347 533">Blue Box</p> 	<p data-bbox="894 506 1018 533">Bar Code</p> 
<p data-bbox="224 949 310 976">Zipper</p> 	<p data-bbox="894 949 1105 976">Electric Blanket</p> 

CANADIAN	NOT
<p data-bbox="77 233 224 260">Anti-G suit</p> 	<p data-bbox="748 233 829 260">Glider</p> 
<p data-bbox="77 831 224 858">Blackberry</p> 	<p data-bbox="748 831 971 858">DNA Sequencing</p> 
<p data-bbox="77 1367 233 1394">Paint Roller</p> 	<p data-bbox="748 1367 899 1394">Eyeglasses</p> 

CANADIAN	NOT
<p data-bbox="224 233 454 262">Heart Pacemaker</p>  <p data-bbox="313 302 782 743">A photograph of a Medtronic Kappa DR701 heart pacemaker. The device is oval-shaped with a metallic finish. It features a clear plastic window on the top left showing internal components. Text on the device includes "IS-1", "Medtronic Kappa™", "DR701", "SN PGU234-56R", and "USA".</p>	<p data-bbox="893 233 1088 262">Artificial Heart</p>  <p data-bbox="1045 352 1448 739">A photograph of a hand holding a transparent artificial heart. The device is roughly heart-shaped and made of clear plastic, showing internal mechanical parts. It has several ports and a circular component on the right side.</p>
<p data-bbox="224 764 552 793">Universal Standard Time</p>  <p data-bbox="358 842 737 1220">A photograph of a standard analog clock face. It is circular with a white background and black numbers from 1 to 12. The hands are black, and the clock is shown from a slightly elevated angle.</p>	<p data-bbox="893 764 990 793">Aspirin</p>  <p data-bbox="1062 842 1373 1045">A photograph of two white, round aspirin tablets. One tablet is slightly behind and to the right of the other, creating a sense of depth. They are set against a plain white background.</p>
<p data-bbox="224 1247 438 1276">Prosthetic Hand</p>  <p data-bbox="318 1314 779 1659">A photograph of a person's arm wearing a prosthetic hand. The prosthetic is dark-colored and appears to be a myoelectric or body-powered hand. The person is wearing a white long-sleeved shirt and a dark glove on the other hand, which is holding the prosthetic.</p>	<p data-bbox="893 1247 1023 1276">Safety Pin</p>  <p data-bbox="1040 1318 1390 1507">A photograph of a standard metal safety pin. It is made of polished metal and is shown in its closed position, with the sharp point tucked into the spring.</p>

CANADIAN	NOT
<p data-bbox="77 233 170 260">Insulin</p> 	<p data-bbox="748 233 894 260">Matchstick</p> 
<p data-bbox="77 825 310 852">Robertson Screw</p> 	<p data-bbox="748 825 873 852">Paperclip</p> 
<p data-bbox="77 1302 180 1329">Pablum</p> 	<p data-bbox="748 1302 829 1329">Pencil</p> 

CANADIAN	NOT
<p data-bbox="224 233 435 262">Pealess Whistle</p> 	<p data-bbox="893 233 1019 262">Tetra Pak</p> 
<p data-bbox="224 667 354 697">Lightbulb</p> 	<p data-bbox="893 667 1123 697">Pencil Sharpener</p> 
<p data-bbox="224 1173 483 1203">Electric Wheelchair</p> 	<p data-bbox="893 1173 1062 1203">Stethoscope</p> 

CANADIAN	NOT
<p data-bbox="77 233 191 260">CADPAT</p> 	<p data-bbox="748 233 870 260">Gore Tex</p> 
<p data-bbox="77 730 240 758">Goalie Mask</p> 	
<p data-bbox="77 1276 215 1304">Plexiglass</p> 	

CANADIAN	NOT
<p data-bbox="224 254 435 285">Alkaline Battery</p> 	
<p data-bbox="224 739 375 770">Egg Carton</p> 	
<p data-bbox="224 1186 399 1218">Garbage Bag</p> 	

THIS PAGE INTENTIONALLY LEFT BLANK

SUGGESTED ACTIVITIES: *GREY OWL* VIDEO

ACTIVITY: WHY MOVE TO CANADA?

TIME: 30 min

TRAINING LEVEL: 1–4

PRE-ACTIVITY INSTRUCTIONS:

Gather the required resources:

- Flipchart paper,
- Pens / pencils, and
- Markers.

ACTIVITY INSTRUCTIONS:

1. Show the cadets the *Grey Owl* Heritage Minutes video.
2. Divide the cadets into teams of three or four.
3. Distribute flipchart paper and markers to each team.
4. Give the teams 15 min to brainstorm and answer the following question: “*What is it about Canada that makes people from all over the world decide to move here and become citizens?*”
5. Give each team 2–3 min to present their answers to the rest of the teams.
6. After all of the teams have presented, have the cadets compare the answers to compile a master list.
7. Display the master list for the rest of the corps / squadron to see.

SUGGESTED ACTIVITIES: GREY OWL VIDEO

ACTIVITY: “LET’S MARKET CANADA”

TIME: 60 min

TRAINING LEVEL: 3–4

PRE-ACTIVITY INSTRUCTIONS:

Gather the required resources:

- Canada: “The” Place to Live! fact-sheet template located at Appendix 1,
- Flipchart paper,
- Pens / pencils, and
- Markers.

ACTIVITY INSTRUCTIONS:

1. Show the cadets the *Grey Owl* Heritage Minutes video.
2. Divide the cadets into teams of three or four.
3. Distribute flipchart paper, markers and fact-sheet template to each team.
4. Give the teams 35 min to create a marketing campaign to sell Canada around the world, including a poster, a slogan and a fact-sheet of reasons why Canada is “the place to live.”
5. Give each team 5 min to present their campaign to the rest of the teams.
6. Declare the team with the most convincing campaign the “Canadian Marketeers.”
7. Display campaign materials for the rest of the corps / squadron to enjoy.

CANADA

"The" Place to Live!

THIS PAGE INTENTIONALLY LEFT BLANK

SUGGESTED ACTIVITY: HERITAGE MINUTES VIDEO

ACTIVITY: STORYBOARD / DIY HERITAGE MINUTES VIDEO

TIME: 60 min

TRAINING LEVEL: 1–4

PRE-ACTIVITY INSTRUCTIONS:

Gather the required resources:

- Storyboard template located at Appendix 1,
- Pens / pencils,
- Markers, and
- Video recording devices, if available.

ACTIVITY INSTRUCTIONS:

1. Show the cadets two or three of the Heritage Minutes videos.
2. Divide the cadets into teams of three or four.
3. Distribute copies of the Heritage Minutes video template and pencils to each team.
4. Have each team choose a prominent Canadian figure, event or symbol to be the subject of their own one-minute Heritage Minutes video.
5. Give the teams 20 min to brainstorm their own concept for a one-minute “Heritage Minutes” video and create a basic script / stick figure storyboard using the template provided.
6. If resources allow, have the teams record their videos in addition to creating a storyboard. A variety of devices can be used, such as cell phones, digital cameras, or video cameras.
7. Give each team 2–3 min to explain their concept and present their storyboard / video to the rest of the teams.
8. The corps / squadron Commanding Officer may authorize exceptional videos to be uploaded to corps / squadron websites / Youtube channels or shown at Annual Ceremonial Reviews, Mess Dinners, etc.

THIS PAGE INTENTIONALLY LEFT BLANK

HERITAGE MINUTES VIDEO
STORYBOARD TEMPLATE

Name of Project: _____

Group Members: _____













THIS PAGE INTENTIONALLY LEFT BLANK



COMMON TRAINING
ALL TRAINING LEVELS
INSTRUCTIONAL GUIDE



SECTION 8

EO MX01.01H – PARTICIPATE IN CITIZENSHIP LEARNING STATIONS

Total Time:

One session (3 periods) = 90 min

PREPARATION

PRE-LESSON INSTRUCTIONS

This IG supports EO MX01.01H (Participate in Citizenship Learning Stations) located in A-CR-CCP-701/PG-001, *Royal Canadian Army Cadets Green Star Qualification Standard and Plan*, Chapter 4.

Select learning stations, and plan and prepare activities. Learning station activities are located at Annexes A–M.

Learning Station	Annex	Self-Directed	Instructor Directed	Time		Trg Lvl	
				15 min	30 min	1-2	3-4
Rights and Responsibilities of Canadian Citizens	A	X	X	X		X	X
Great Canadian Trivia Game	B	X	X	X		X	X
History of Canada in 30 Min or Less	C		X		X	X	X
Canadian Contributions: Parking Spaces	D	X	X		X	X	
Canadian Contributions: Great Canadians	E	X	X		X		X
How Canadians Govern Themselves	F		X		X	X	X
Elections	G		X	X		X	X
Canadian Justice System	H	X	X		X	X	X
Canadian Symbols: Treasure Hunt	I		X		X	X	
Canadian Symbols: Coat of Arms	J	X	X		X		X
Canada's Economy	K	X			X	X	X
Canada's Regions: Symbols Map	L	X	X		X	X	
Canada's Regions: Worksheet	M	X			X		X

In addition to the suggested activities at Annexes A–M, instructors may choose to create their own interactive, challenging and fun activities.

Gather the required resources for the selected activities, as well as a stop watch or other timer. Some learning stations require assistant instructors.

PRE-LESSON ASSIGNMENT

Nil.

INTRODUCTION

APPROACH

An in-class activity was chosen for this lesson as it is a fun and interactive way to build on the cadets' knowledge of citizenship.

REVIEW

Nil.

OBJECTIVES

By the end of this session the cadets shall have gained an understanding of citizenship topics covered in the selected learning stations.

IMPORTANCE

It is important for cadets to understand our national history, government, identity and values in order to help them become responsible citizens and members of their communities.

ACTIVITY

1. Divide the cadets into teams of four.
2. Arrange a system of rotation for groups to move through the stations. Explain the procedure for moving from one station to the next, the time allotted for each station and the signal to switch.
3. Assign each team to their first learning station.
4. Supervise and provide guidance where necessary.

CONCLUSION

METHOD OF EVALUATION

Nil.

CLOSING STATEMENT

It is important for cadets to participate in citizenship learning stations to develop an understanding of their roles and history as Canadian citizens.

INSTRUCTOR NOTES / REMARKS

There are numerous potential leadership opportunities for cadets when conducting these learning stations:

- Phase Five / Master Cadet / Proficiency Level Five cadets may plan, prepare and conduct the learning stations activity as a leadership project IAW PO 503 (Lead Cadet Activities); and
- Phase Three / Silver Star / Proficiency Level Three, Phase Four / Gold Star / Proficiency Level Four, and Phase Five / Master Cadet / Proficiency Levels Five cadets may complete leadership assignments, such

as leading or supervising individual learning stations, IAW POs 303 (Perform the Role of a Team Leader), 403 (Act as a Team Leader), and 503 (Lead Cadet Activities).

REFERENCES

Citizenship and Immigration Canada. (2012). *Discover Canada: The rights and responsibilities of Citizenship*. Retrieved March 12, 2013 from <http://www.cic.gc.ca/english/pdf/pub/discover.pdf>

THIS PAGE INTENTIONALLY LEFT BLANK

RIGHTS AND RESPONSIBILITIES OF CITIZENS

OBJECTIVE: The aim of this learning station is to familiarize cadets with the rights and responsibilities of Canadian citizens, and have them consider their connection to those rights and responsibilities.

TIME: 15 min

TRAINING LEVEL: 1-4

PRE-ACTIVITY INSTRUCTIONS:

- This activity may be assigned an instructor or be self-directed by the cadets.
- Provide a quiet space with a table and seating for all team members.
- Gather the required resources:
 - Rights and Responsibilities instruction sheet at Appendix 1 (1 copy),
 - Rights and Responsibilities of Canadian Citizens handout at Appendix 2 (enough for each team),
 - Citizens' Wall sheet at Appendix 3 (1 copy),
 - Flipchart and markers, and
 - Masking tape.
- Print the Rights and Responsibilities of Canadian Citizens handouts and place on the table.
- Post the Rights and Responsibilities instruction sheet on the wall or tape it to the table.
- Leave a separate area on the wall – The Citizens' Wall – for teams to post their finished lists of rights and responsibilities next to the Citizens' Wall sheet (ideally, this space should be away from the table and on the way to the next station).

ACTIVITY INSTRUCTIONS:

Have the cadets read and follow the Rights and Responsibilities instruction sheet.

THIS PAGE INTENTIONALLY LEFT BLANK

INSTRUCTIONS: RIGHTS AND RESPONSIBILITIES

Congratulations! You have just founded your own new country. Your first order of business is to decide what rights and freedoms your citizens will enjoy and what their responsibilities will be.

1. Read the rights and responsibilities of Canadian citizens.
2. Discuss. Will your country have the same rights and responsibilities? Why or why not?
3. Brainstorm ideas and write the list of Rights and Responsibilities for your country on the flipchart.
4. Add your list to the Citizens' Wall, and take a moment to compare your list to other teams' and discuss.

Things to think about...

- ✦ *In some countries, like Norway and Israel, citizens must serve in the military. How would life in your country be different than in Canada if you had this responsibility?*
- ✦ *Switzerland has four national languages. How many official languages would your country have? How would your citizens' rights reflect this?*
- ✦ *There was a time when only men could vote or be elected in Canada. Now all citizens over 18 can vote. Who would be allowed to vote in your country, and how will this affect their responsibilities?*

THIS PAGE INTENTIONALLY LEFT BLANK

RIGHTS AND RESPONSIBILITIES OF CANADIAN CITIZENS

Rights and Freedoms

Canadians are free to: follow the religion of their choice; hold and express their own opinions; assemble peacefully in support of a cause; and make or join groups that promote a common interest. In 1982, the Constitution of Canada was amended to include the Canadian Charter of Rights and Freedoms, which explains our fundamental freedoms and sets out additional rights. Some of these are:

Equality – the law protects everyone equally and does not discriminate against anyone.

Mobility – you are allowed to live anywhere in Canada, and to leave the country if you wish.

Democratic – once you turn 18, you have the right to vote and run for political office.

Legal – if you are accused of a crime, you are presumed innocent unless proven guilty and have a right to be represented by a lawyer in a court of law. You are also allowed to have an interpreter during court proceedings.

Language – the Canadian government gives English and French equal rights and privileges, and you can communicate with them in either official language.

If any Canadian feels that their rights have been violated, they are allowed to address that violation in court.

Responsibilities

Rights always come with responsibilities. Some of your responsibilities as a Canadian are to:

Understand and obey the law

Allow other Canadians to enjoy their rights and freedoms

Vote and to participate in the democratic political system

Appreciate and help preserve Canada's environment and multicultural heritage

Be an active and helpful member of the community

THIS PAGE INTENTIONALLY LEFT BLANK

Rights and Responsibilities of Canadian Citizens

CITIZENS' WALL

Post the list of your country's rights
and responsibilities here. How does your list
compare to the others displayed on this wall?

Do you agree with their decisions?
Why or why not?

THIS PAGE INTENTIONALLY LEFT BLANK

THE GREAT CANADIAN TRIVIA GAME

OBJECTIVE: The aim of this learning station is to familiarize cadets with Canadian history and culture.

TIME: 15 min

TRAINING LEVEL: 1-4

PRE-ACTIVITY INSTRUCTIONS:

- This activity may be assigned an instructor or be self-directed by the cadets.
- Gather the required resources:
 - Great Canadian Trivia Game Instruction sheet located at Appendix 1 (1 copy),
 - Great Canadian Trivia Game game cards located at Appendix 2 (one set), and
 - Paper and pens or markers for the cadets to make score sheets.
- Print, cut and fold trivia cards so that the answer (with the picture) is hidden on the inside—if available, card stock will work well.
- Set up this learning station in an area where the players will not disrupt other cadets—it may be a noisy game.
- Set up seating for all players.
- Place trivia cards in a bowl, hat, helmet, etc. for players to draw from.
- Post the instruction sheet somewhere visible.
- Material for additional trivia questions may be found at www.101things.ca and www.thecanadianencyclopedia.com.

ACTIVITY INSTRUCTIONS:

Have cadets read and follow the instruction sheet.

THIS PAGE INTENTIONALLY LEFT BLANK

WELCOME TO THE GREAT CANADIAN TRIVIA GAME!

It's time to test your knowledge of Canadian history and culture! Here's how to play the game:

1. Divide your team in two. One half will be playing against the other.
2. Make a score sheet for your game on the paper provided.
3. Choose a side to go first. A member of the opposing side will get to ask the question.
4. Draw a question card. You can open it, but don't show anyone the answer inside. Read the question on the outside, followed by the multiple choice options.
5. If the side guessing gets the question wrong, the other side can steal by getting the right answer (but the person asking can't help them!). Go back and forth between the teams until the correct answer is found.
6. Once someone says the correct answer, open the card and read the inside to the team. You can show the picture, too.
7. Record correct answers on the score sheet. Basic cards are worth 1 point, Intermediate 2 points and Expert 3 points.
8. Know all the answers? Make up some Canadian trivia questions of your own and see if the other team can answer them!

THIS PAGE INTENTIONALLY LEFT BLANK

The Village. Early European explorers may have believed the Iroquois word "Kanata," which refers to any settlement, was the name of the country. However it came about, the name represents Canada as a welcoming community of neighbours.



Fold

Fold

Cut



Aboriginal peoples. One of Canada's most famous artists is painter Norval Morrisseau, called Copper Thunderbird, whose work reflects his aboriginal heritage.

The Underground Railroad brought fleeing slaves safely to Canada, and many of them decided to settle here. Mary Ann Shadd Cary, whose parents were part of the Underground Railroad, became an activist for African-Canadian rights and Canada's first female publisher.



Charlottetown, P.E.I. Interestingly, P.E.I. didn't become part of Canada with New Brunswick, Nova Scotia, Ontario and Quebec in 1867, but joined later in 1873. The bridge that connects N.B. and P.E.I. is called the Confederation Bridge in honour of Charlottetown's role in the birth of the country.



 **Basic**

The word "Canada" most likely comes from a First Nations word that means:

- a) The river
- b) The village
- c) The maple tree
- d) The place with snow

 **Basic**

The First Nations, Inuit and Metis, descendents of the first people to live in this country, are Canada's...

- a) Aboriginal peoples
- b) Founding fathers
- c) Official culture
- d) National peoples

 **Basic**

Upper Canada was the first British colony to work to abolish slavery. Many former slaves escaped to Canada from the U.S. through a network called the:

- a) Trans-Canada Trail
- b) Anti-Slavery Network
- c) Underground Railroad
- d) Canadian Red Cross

 **Basic**

Canada officially became a country on July 1, 1867, but it was a long process. The first conference about confederation was in 1864. Where was it held?

- a) Ottawa, Ont.
- b) Halifax, N.S.
- c) Montreal, Que.
- d) Charlottetown, P.E.I.

Vikings. These Icelandic explorers established a settlement in what is now known as L'Anse aux Meadows, Newfoundland and Labrador, over a thousand years ago.



Fold

Fold

Cut

Louis Riel was eventually executed for treason for his role in armed uprisings against the government, but he is regarded by many Canadians as a defender of Métis rights. The government established the province of Manitoba and the North West Mounted Police (now the RCMP) in response to Riel's rebellion.



Laura Secord lived in American-occupied territory that is now part of Ontario. The information she passed on helped the British defeat the Americans. Laura Secord Chocolates was named in her honour on the 100th anniversary of her trek.



Acadians. Many present-day Acadians live in New Brunswick, Canada's only bilingual province. The word "Cajun" comes from Acadians who moved to Louisiana after losing their homes to the British in the 1770s.



Acadian Flag



Intermediate

Many Canadians are descended from European immigrants. But who were the very first Europeans to visit North America?

- a) The French
- b) The English
- c) The Vikings
- d) The Russians



Intermediate

The Métis are a distinct Canadian culture with both Aboriginal and European ancestry. Which Métis leader started a rebellion that resulted in the formation of both Manitoba and the RCMP?

- a) William Lyon Mackenzie
- b) Louis Riel
- c) Laura Secord
- d) Sir Isaac Brock



Intermediate

In the War of 1812, the United States tried to invade Upper Canada. Which Canadian heroine traveled 30 km to warn the British army of an impending American attack?

- a) Jeanne Mance
- b) Mary Ann (Shadd) Carey
- c) Laura Secord
- d) Florence Nightingale



Intermediate

The descendants of French colonists who settled the Atlantic provinces in the 1600s are called...

- a) Acadians
- b) Quebecois
- c) Métis
- d) Haligonians

Dominion Day, because Canada's official name was the Dominion of Canada. The term came from a section of the Bible that described "dominion from sea to sea and from the river to the ends of the earth," and was chosen because it reflected the image of a strong, united Canada.



Fold

Fold

Cut

Loyalists were American colonists still loyal to Britain. They settled in Canada, and many Canadian communities and institutions now bear the word "loyalist" in their names. Though an independent country, Canada remains part of the Commonwealth.



Scotland. Many Canadians' ancestors came from Scotland and Ireland. Nova Scotia actually means "New Scotland." Canada's culture is influenced by the cultures of the people who make up our country, and the military in particular keeps many Scottish traditions.



Lord Strathcona was also a great supporter of Cadets, and Banff, Canada's first national park, was named after his birthplace in Scotland. The railroad was actually built by Chinese and European immigrants, often under terrible conditions. Banff was founded after some of these railroad workers discovered beautiful hot springs in the Rocky Mountains of Alberta.

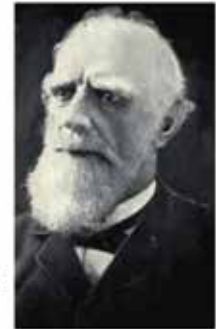

 **Expert**

On July 1, we celebrate Canada Day, but prior to 1982, it had a different name. What was it originally called?

- a) Independence Day
- b) Confederation Day
- c) Dominion Day
- d) Happy Birthday Canada

 **Expert**

During the American Revolution, Canada became a safe haven for supporters of the British. What were they called?

- a) Monarchists
- b) Loyalists
- c) Rebels
- d) Pacifists

 **Expert**

Canada's first Prime Minister was Sir John Alexander Macdonald, one of the Fathers of Confederation. Where was he born?

- a) Scotland
- b) Canada
- c) England
- d) The United States

 **Expert**

The Canadian Pacific Railway (CPR) was completed in 1885. The director of CPR was Donald Smith, otherwise known as:

- a) Lord Beaverbrook
- b) Lord Strathcona
- c) The Duke of Edinburgh
- d) Lord Durham

Astronauts. Marc Garneau became the first Canadian in space in 1984. Canada has contributed personnel and technology to many space missions. The "Canadarm" mechanical arms mounted on space shuttles and the International Space Station were designed and built in Canada.



Fold

Fold

Cut

British Columbia. Terry Fox started his "Marathon of Hope" in Newfoundland, running the equivalent of a marathon each day with a prosthetic leg. Though he was never able to reach his goal, Canadians across the country run to raise money for cancer research each year in his memory.



Asia. Chinese languages are among the most commonly spoken at home by Canadians. Every year, communities all over the country celebrate Chinese New Year and other Asian traditions.



Dr. Emily Stowe was also the first woman to practice medicine in Canada. Thanks to her efforts and those of other suffragettes, women gained the right to vote starting in 1916.



 **Basic**

Roberta Bondar, Marc Garneau and Chris Hadfield are the names of Canadian....

- a) Inventors
- b) Astronauts
- c) Prime Ministers
- d) Archaeologists

 **Basic**

Terry Fox was a young man who began a cross-Canada run to raise money for cancer research. What province was he from?

- a) Newfoundland and Labrador
- b) Ontario
- c) British Columbia
- d) Saskatchewan

 **Intermediate**

Immigrants have come to Canada from all over the world, but since the 1970s, most new Canadians come from one particular area. Where is it?

- a) Africa
- b) Asia
- c) Europe
- d) South America

 **Expert**

At one time, only adult men who owned property were allowed to vote. The movement to give women a vote was led by:

- a) Dr. Emily Stowe
- b) Jean Chretien
- c) Laura Secord
- d) The province of Manitoba

HISTORY OF CANADA IN 30 MIN OR LESS

OBJECTIVE: The aim of this learning station is to familiarize cadets with some key events in Canadian history.

TIME: 30 min

TRAINING LEVEL: 1–4

PRE-ACTIVITY INSTRUCTIONS:

- Assign an instructor to this activity.
- Provide an area large enough for all team members with a table and ample wall space to display cards. Ideally, this space should be away from the table and on the way to the next station.
- Gather the required resources:
 - History of Canada in 30 Min or Less timeline cards at Appendix 1 (1 set per team),
 - History of Canada in 30 Min or Less answer key at Appendix 2, and
 - Masking tape.
- Print a set of the History of Canada in 30 Min or Less timeline cards for each team. Cut them into individual cards and place them on the table.
- Post the History of Canada in 30 Min or Less activity instruction sheet on the wall or tape it to the table.

ACTIVITY INSTRUCTIONS:

1. Divide the cadets into two teams.
2. Give the teams 15 min to arrange their timeline cards in chronological order and post them on the wall using the masking tape.
3. Check the answer key to determine if each team's timeline is arranged correctly.
4. If there is enough time remaining in the activity, give the cadets the chance to adjust the order of their cards.
5. Declare the team with the most events in the correct order the "Canadian History Buffs."

THIS PAGE INTENTIONALLY LEFT BLANK

HISTORY OF CANADA

IN 30 MINUTES OR LESS



Prehistoric hunters cross over into Canada from Asia



Leif Ericsson leads a Viking expedition to the New World



John Cabot reaches Newfoundland

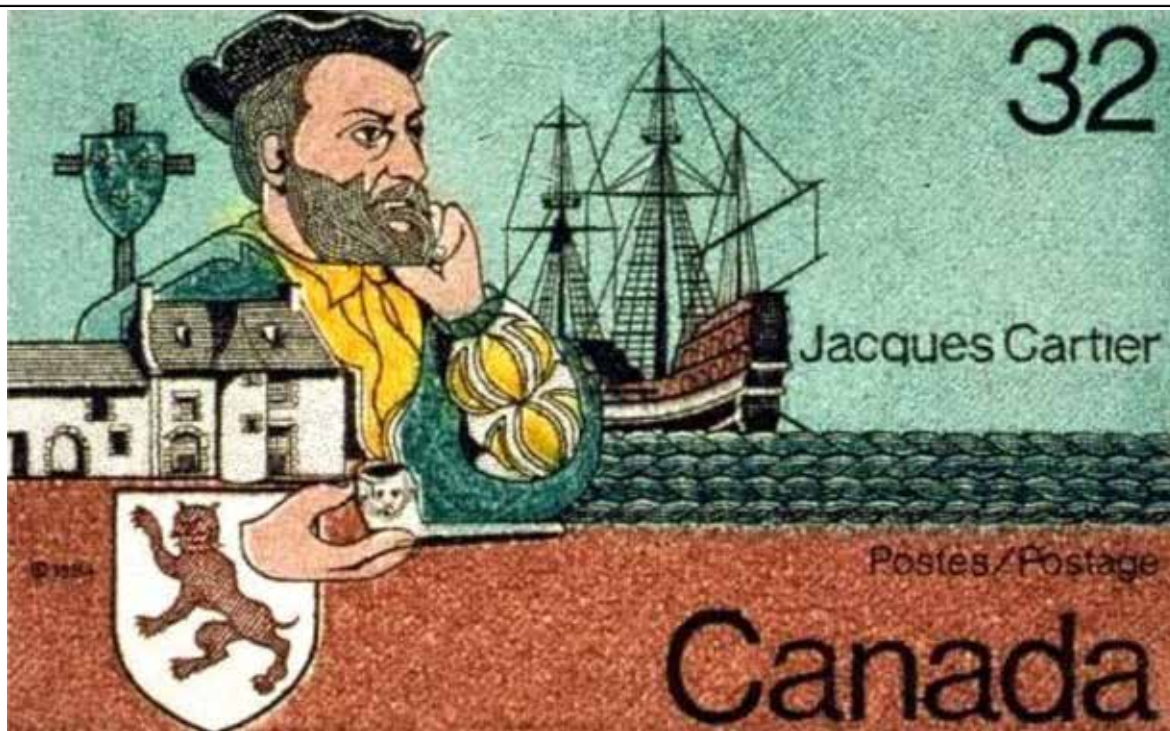

Jacques Cartier first explores the St. Lawrence region



Samuel de Champlain establishes a French colony at Quebec City



Hudson's Bay Company is formed



Expulsion of the Acadians



Battle of the Plains of Abraham: Quebec City is captured



War of 1812: U.S. invades Canada



Confederation (first four provinces: Quebec, Ontario, N.S., and N.B.)



Province of Manitoba is created



British Columbia joins Canada

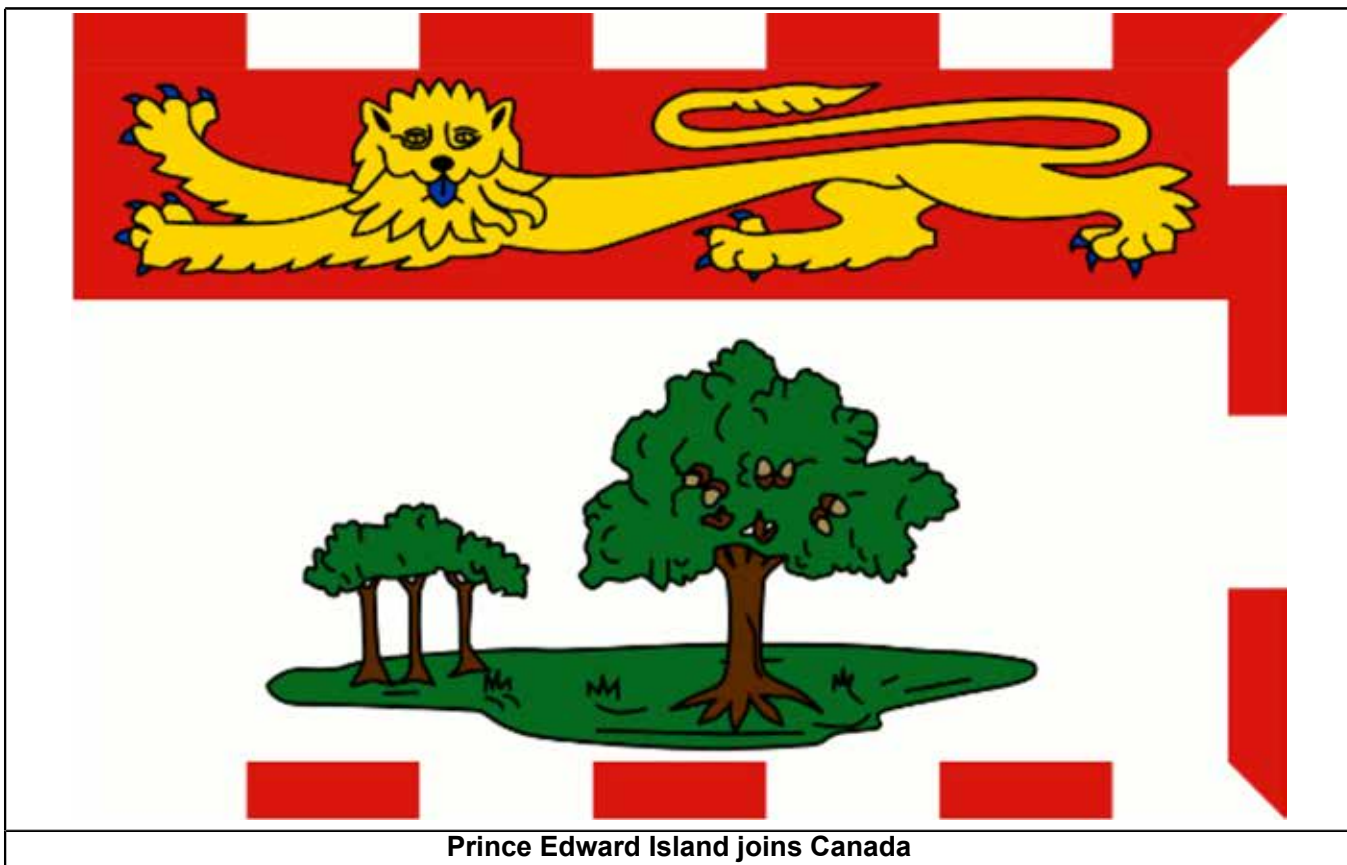



Canadian Pacific Railway is completed



The provinces of Alberta and Saskatchewan are created



World War I



Women win the vote in Manitoba, Saskatchewan, and Alberta



The Great Depression



World War II

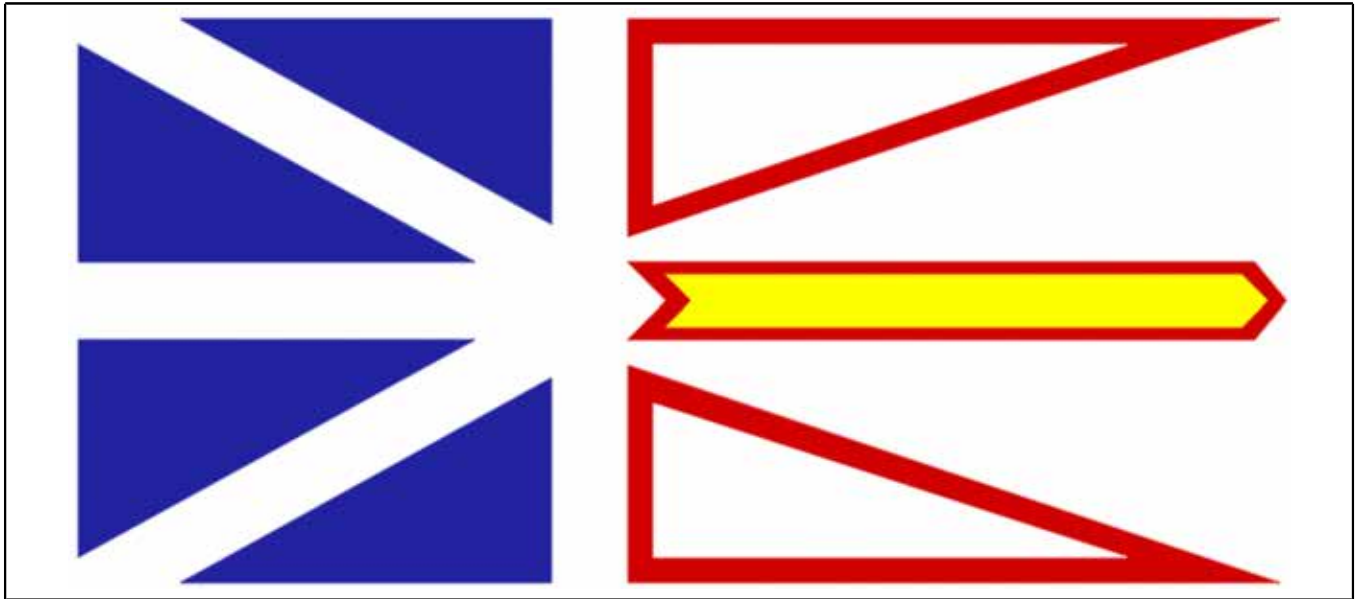

Newfoundland joins Canada



Korean War



St. Lawrence Seaway (major transportation route) officially opens



Native Canadians win the right to vote



Canada gets its own flag



October Crisis: political kidnappings, Ottawa suspends civil rights



Constitution comes home — with a Charter of Rights and Freedoms

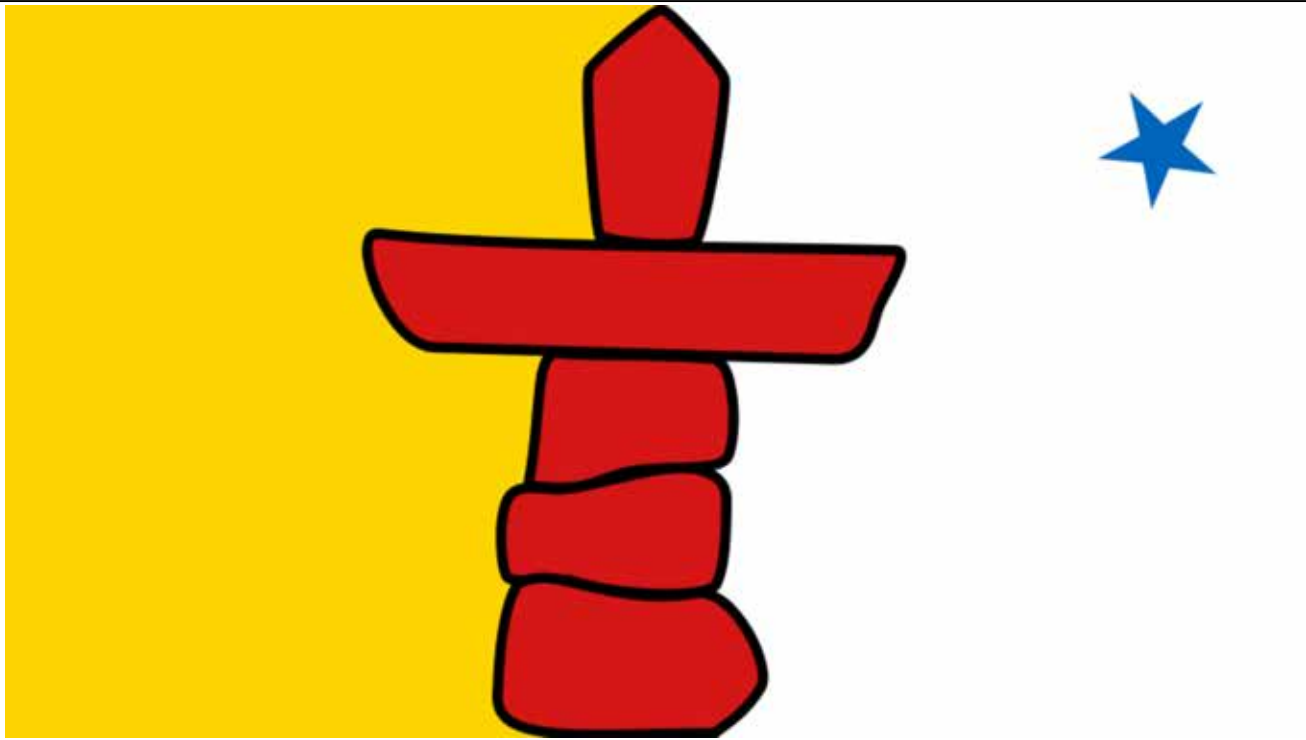

The new Arctic territory of Nunavut is created

HISTORY OF CANADA

IN 30 MINUTES OR LESS

Answer Key

DATE	EVENT
30,000–10,000 BC	Prehistoric hunters cross over into Canada from Asia
circa 1000 AD	Leif Ericsson leads a Viking expedition to the New World
1497	John Cabot reaches Newfoundland
1534	Jacques Cartier first explores the St. Lawrence region
1608	Samuel de Champlain establishes a French colony at Quebec City
1670	Hudson's Bay Company is formed
1755	Expulsion of the Acadians
1759	Battle of the Plains of Abraham: Quebec City is captured
1812–14	War of 1812: U.S. invades Canada
1867	Confederation (first four provinces: Québec, Ontario, N.S., and N.B.)
1870	Province of Manitoba is created
1871, 1873	B.C. and P.E.I. join Canada
1885	Canadian Pacific Railway is completed
1905	The provinces of Alberta and Saskatchewan are created
1914–18	World War I
1916	Women win the vote in Manitoba, Saskatchewan, and Alberta
1939–45	World War II
1949	Newfoundland joins Canada
1950–53	Korean War
1959	St. Lawrence Seaway officially opens
1960	Native Canadians given the right to vote
1965	Canada gets its own flag
1970	October Crisis, Ottawa suspends civil rights
1982	Constitution comes home — Charter of Rights and Freedoms
1999	The new Arctic territory of Nunavut is created

THIS PAGE INTENTIONALLY LEFT BLANK

CANADIAN CONTRIBUTIONS: PARKING SPACES

OBJECTIVE: The aim of this learning station is to familiarize cadets with some key Canadians' contributions to the nation and consider what their contribution may be.

TIME: 30 min

TRAINING LEVEL: 1–2

PRE-ACTIVITY INSTRUCTIONS:

- This activity may be assigned an instructor or be self-directed by the cadets.
- Set up a quiet space with a table and seating for all team members.
- Gather the required resources:
 - Parking Spaces Instructions sheet located at Appendix 1 (1 copy),
 - Parking Spaces Answers and Facts sheet located at Appendix 2 (1 copy),
 - Vehicle and Parking Spaces game cards sheets located at Appendix 3 (1 copy), (game cards may be printed on card stock for better durability),
 - Flipchart paper and markers, and
 - Masking tape.
- Cut out game cards, and cut a parking slot on the dotted line in each parking space card. Game cards may be laminated for repeated use.
- Post the Parking Spaces Answers and Facts sheet and the Parking Spaces Instructions sheet on the wall, so that the answers are covered by the instructions.

ACTIVITY INSTRUCTIONS:

Have the cadets read and follow the Parking Spaces Instructions sheet.

THIS PAGE INTENTIONALLY LEFT BLANK

PARKING SPACES INSTRUCTIONS

Part 1: Great Canadians

Some famous Canadians are going for familiarization rides with the cadets!

However, the drivers, pilots and commanders of these vehicles only have a description of the passengers they're supposed to be picking up, not the passenger's name.

Your mission: Help the drivers find their passengers by matching each vehicle to the correct person.

1. Working as a team, read each vehicle card and try to find the person the card describes. Be careful – some of them are tricky!
2. Remember that gliders can only “park” at the airport, G-wagons at the armoury (with the flag) and ORCA sea training vessels at the jetty.
3. When you figure out which vehicle goes where, “park” the vehicle card next to the corresponding person by sliding it into the slot on the parking space card, like this:

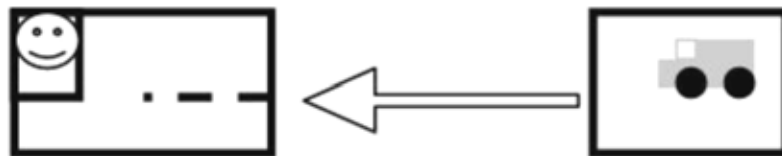

4. Once you're satisfied with all your matches, lift this sheet to check your answers and find out some cool facts about the people in this game! No cheating!

Part 2: What's your contribution?

You don't have to be a best-selling writer, a rock star or a scientist to be a good global citizen.

1. As a group, discuss what each member of your team could contribute to your community, your country or the world.
2. Your contribution could be something big, like changing government policy for the better, or something smaller like volunteering in the community.
3. Write each team member's name on the flip chart, and put their contribution next to it. Remember to take each person's skills, talents and interests into consideration!

THIS PAGE INTENTIONALLY LEFT BLANK

PARKING SPACES

ANSWERS AND FACTS

1 – H: Marshall MacLuhan

Cool Canadian Fact: MacLuhan also predicted the Internet years before it was developed!

2 – A: Emily Carr

Cool Canadian Fact: Carr was one of our first female artists, and is often associated with the famous Group of Seven who pioneered art in Canada.

3 – F: William Shatner

Cool Canadian Fact: Besides acting, Shatner is also a musician, author and film director.

4 – I: Arthur Lipsett

Cool Canadian Fact: The number of Princess Leia's cell in the first *Star Wars* movie, 21-87, came from the name of a short film by Lipsett. Lucas also credits Lipsett with the term "the force."

5 – J: The Montreal Royals

Cool Canadian Fact: Robinson was so beloved by Montreal baseball fans that a cheering crowd of them once followed him and his wife all the way from the ball field to the train station!

6 – E: Dr. David Suzuki

Cool Canadian Fact: Besides hosting TV and radio shows, Suzuki has written over 50 books – 15 of them for children!

7 – L: Glenn Gould

Cool Canadian Fact: Along with winning three Juno awards and five Grammy awards, Gould was made a Companion of the Order of Canada, but declined the honour because he felt he was too young to receive it.

8 – B: Cirque du Soleil

Cool Canadian Fact: Performers come from all over the world to join Cirque du Soleil, which employs people from over 40 different countries.

9 – C: Dr. Frederick Banting

Cool Canadian Fact: Banting was knighted by King George V in recognition of his work... so he is actually *Sir* Dr. Frederick Banting!

10 – G: Jacques Plante

Cool Canadian Fact: When Plante was the goaltender for the Montreal Canadiens, they won the Stanley Cup five times in a row.

11 – D: Romeo Dallaire

Cool Canadian Fact: Dallaire has received many honours for his humanitarian work. As one of Canada's great heroes, he helped carry the Canadian flag at the 2010 Olympic games.

12 – K: Margaret Atwood

Cool Canadian Fact: Among her many awards and accomplishments, Atwood holds an honorary degree from the Royal Military College of Canada.

THIS PAGE INTENTIONALLY LEFT BLANK



5

Your passengers gave great African-American athlete Jackie Robinson his start by breaking the "colour barrier" and making him a member of their club.



6

Your passenger is an environmentalist and scholar known around the world, especially for hosting a science TV show seen in over 40 countries!



7

Your passenger has been called one of the most celebrated musicians of the 20th century, being especially well-known for interpretations of Bach on piano.



9

Your passenger is a Nobel Prize-winning Canadian scientist who discovered insulin, changing the lives of people all over the world who suffer from diabetes.



8

Your passengers are a team of internationally-famous entertainers, a group originally started by two former street performers from Montreal.



10

Your passenger is an innovator who changed our national winter sport forever, by inventing a mask to protect goal tenders from injury.



1 Your passenger is a communications philosopher who revolutionized the way people think about the media. This person coined the terms "Global Village" and "Channel Surfing."

3



Your passenger is a Canadian actor known all over the world, especially for boldly going "where no one has gone before."

2



Your passenger is a great artist and writer, best known for highly-stylized paintings of Aboriginal symbols and the Canadian wilderness.

4



Your passenger is a film maker who once worked for the National Film Board of Canada. *Star Wars* creator George Lucas says this person was one of his greatest influences!

11













Once a general in the Canadian Armed Forces, your passenger has become an international advocate for human rights, as well as a senator and an author.

12



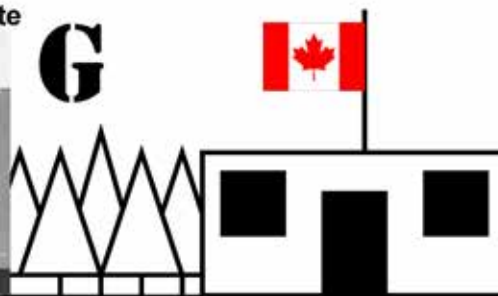

Your passenger is an award-winning Canadian novelist and poet, who draws attention to important issues through fictional stories.

<p>H Marshall MacLuhan</p>   <p>Cut here</p> <p>2 0</p>	<p>Emily Carr</p> <p>A</p>   <p>Cut here</p>
<p>B Cirque du Soleil</p>   <p>Cut here</p> <p>2 0</p>	<p>Dr. Frederick Banting</p> <p>C</p>   <p>Cut here</p>
<p>L Glenn Gould</p>   <p>Cut here</p> <p>2 0</p>	<p>Jacques Plante</p> <p>G</p>   <p>Cut here</p>

Dr. David Suzuki



E



Cut here

I

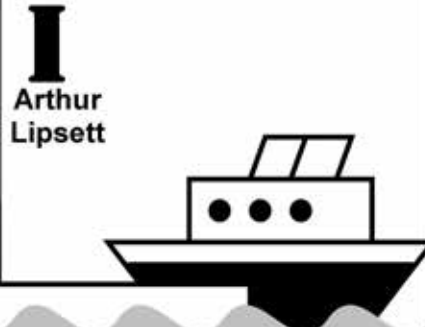
Arthur Lipsett



Cut here

J

The Montreal Royals





Cut here

20

Romeo Dallaire



D



Cut here

K

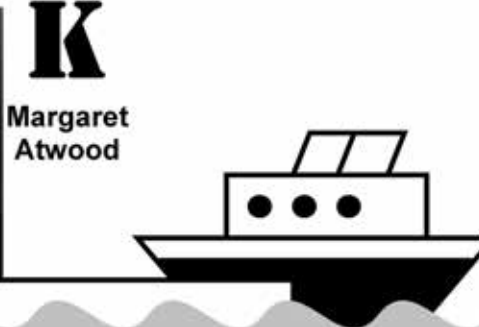

Margaret Atwood



Cut here

William Shatner

F



Cut here

CANADIAN CONTRIBUTIONS: GREAT CANADIANS

OBJECTIVE: The aim of this learning station is to familiarize cadets with some key Canadians' contributions to the nation and consider what their contribution may be.

TIME: 30 min

TRAINING LEVEL: 3–4

PRE-ACTIVITY INSTRUCTIONS:

- This activity may be assigned an instructor or be self-directed by the cadets.
- Identify a quiet space with a table and seating for all team members.
- Gather the required resources:
 - Canadian Contributions Instructions sheet located at Appendix 1 (1 copy),
 - Canadian Contributors sheet located at Appendix 2 (1 per cadet), and
 - Flipchart paper and markers.
- Place the Canadian Contributors sheets on the table in a folder or envelope.
- Post the Canadian Contributions Instructions sheet next to the flipchart.

ACTIVITY INSTRUCTIONS:

Have the cadets read and follow the Canadian Contributors Instructions sheet.

THIS PAGE INTENTIONALLY LEFT BLANK

CANADIAN CONTRIBUTIONS

INSTRUCTIONS

Part 1: Great Canadians

Who are some Canadians who have made a difference in the world through their knowledge, abilities and dedication?

1. As a group, brainstorm to find the names of at least one Canadian who has made a major contribution having to do with each of the following:

Sport

Music

Art

Literature

Science and Technology

Philosophy and Ethics

Human or Animal Rights

2. Write the name of each person on the flip chart paper, along with the contribution they have made.
3. When you finish, compare your list to the handout in the folder.

Part 2: What's your contribution?

You don't have to be a best-selling writer, a rock star or a scientist to be a good global citizen.

1. As a group, discuss what each member of your team could contribute to your community, your country or the world.
2. Your contribution could be something big, like changing government policy for the better, or something smaller like volunteering in the community.
3. Write each team member's name on the flip chart, and put their contribution next to it. Remember to take each person's skills, talents and interests into consideration!

THIS PAGE INTENTIONALLY LEFT BLANK

CANADIAN CONTRIBUTORS

Did any of these famous Canadians make your list? Which of the categories do their contributions fall into?



Emily Carr

One of Canada's first great female artists and writers, she was best known for her highly-stylized paintings of Aboriginal symbols and the Canadian wilderness. She was also associated with the pioneering Group of Seven artists.



Arthur Lipsett

A film maker for the National Film Board of Canada, he became one of *Star Wars* creator George Lucas's greatest ARTISTIC influences. The number of Princess Leia's cell in *Star Wars*, 21-87, is the name of a short film by Lipsett.



Romeo Dallaire

Once a general in the Canadian Armed Forces, he has become an international advocate for human rights recognized all over the world for his humanitarian work. He is also a senator and the author of several books.



Margaret Atwood

An award-winning Canadian novelist and poet, who often draws attention to important issues through her fictional stories. Among her many awards and honours, she holds an honorary degree from the Royal Military College of Canada.



Dr. David Suzuki

An active environmentalist, broadcaster and scholar known around the world, especially for hosting a science TV show, *The Nature of Things*, seen in over 40 countries. He is also the author of numerous books, many of them for children.



Glenn Gould

One of the most celebrated musicians of the 20th century, he was especially well-known for his interpretations of Bach on piano. Along with three Juno awards and five Grammys, he was made a companion of the Order of Canada, but declined because he felt he was too young for such an honour.



Marshall MacLuhan

A communications philosopher who revolutionized the way people think about the media. He coined the terms "Global Village" and "Channel Surfing," and predicted the Internet decades before it came into being.



William Shatner

A Canadian actor, director, writer, musician and recording artist known worldwide, especially for his iconic role in the TV show *Star Trek*. He also played an animated opossum alongside fellow Canadian Avril Lavigne in *Over the Hedge*.



Sir Frederick Banting

A Nobel Prize-winning Canadian scientist, he discovered insulin. His work changed the lives of thousands of people around the world who suffer from diabetes. He was knighted by King George V in recognition of his discovery.



Jacques Plante

As a goaltender, he became an innovator who changed our national winter sport forever, by inventing a mask to protect goalies from injury. While he was playing for the Montreal Canadiens, they won the Stanley Cup five times in a row.

HOW CANADIANS GOVERN THEMSELVES

OBJECTIVE: The aim of this learning station is to familiarize cadets with the types of substantive issues debated by elected representatives.

TIME: 30 min

TRAINING LEVEL: 1–4

PRE-ACTIVITY INSTRUCTIONS:

- Assign an instructor to this activity.
- Find a resolution debated in the Parliament of Canada (a record of votes in Parliament is available at openparliament.ca > VOTES (openparliament.ca/bills/votes/) [disregard procedural votes and votes on bills]) that is appropriate for discussion by cadets, such as resolutions concerning national days or government priorities, taking into consideration:
 - the relevance of the motion to the cadets,
 - the complexity of the motion,
 - whether the motion is controversial enough to allow for motivated debate, and
 - the knowledge level of the cadets.
- If an appropriate motion is not available, select a resolution from the sample resolutions located at Appendix 1 or create your own.
- Gather the required resources:
 - a method of displaying the resolution (such as a whiteboard or flipchart), and
 - five chairs and two desks, arranged as per Figure F-1.

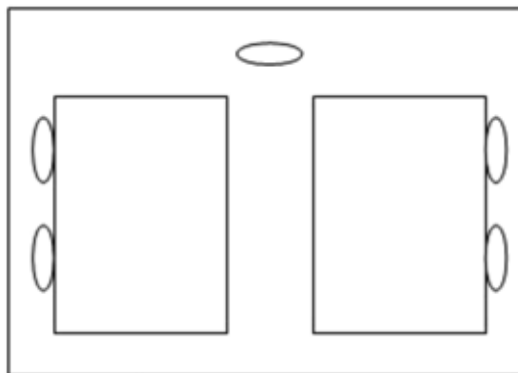

Figure F-1 Orientation of Training Space

ACTIVITY INSTRUCTIONS:

1. Explain to cadets that resolutions are a method the House of Commons can use to collectively express its opinion on a subject. Unlike bills, which, after completing the legislative process, become laws, adopted resolutions are not binding, but still provide an opportunity for substantive debate and can influence future policy. The non-binding nature of motions explains the wording (“That, in the opinion of the House, the government *should consider*”).
2. Introduce the resolution to the cadets and ensure it is understood.
3. Designate half the team “in favour” of the resolution and half “opposed” to the resolution.
4. Give the cadets 7 min to brainstorm arguments for or against the motion and decide which cadet on their side will speak first and which second.
5. Starting with those in favour of the motion, give a cadet on each side 2 min to stand and present their arguments.
6. Starting with those in favour of the motion, give a cadet on each side 2 min to stand and rebut the other side’s arguments or present new arguments.
7. Have the cadets vote on the motion through a voice vote (cadets may vote their conscience, rather than voting on the basis assigned earlier), by:
 - (a) instructing those in favour to say “yea;”
 - (b) instructing those opposed to say “nay;”
 - (c) declaring the result; and
 - (d) in the case of a tie, casting the deciding vote by voting in such a way as to support the status quo (opposing resolutions that implement change).
8. To develop an understanding of the different tensions on Members of Parliament, pose to the cadets the following questions:
 - (a) What if you felt strongly about this issue, but a majority of your constituents felt another way. Would this affect how you voted? How?
 - (b) In this simulation, you were asked to support a position you may not have agreed with. Similar situations occur for Members of Parliament. What if you felt strongly about this issue, but your party and colleagues had decided to take a different stand. Would this affect how you voted? How?
9. As time permits, have the cadets brainstorm resolutions they may move if they were Members of Parliament.

SAMPLE RESOLUTIONS

That, in the opinion of the House, the government should consider restoring the death penalty for the most heinous criminal offences.

That, in the opinion of the House, the government should consider making voting compulsory in Canada.

That, in the opinion of the House, the government should consider abolishing the monarchy.

That, in the opinion of the House, the government should consider acknowledging the inherent rights of animals.

THIS PAGE INTENTIONALLY LEFT BLANK

ELECTIONS

OBJECTIVE: The aim of this activity is to consider the roles of elected representatives and decide what priorities and characteristics the cadets, as constituents, would like the ideal candidate to hold.

TIME: 15 min

TRAINING LEVEL: 1–4

PRE-ACTIVITY INSTRUCTIONS:

- Assign an instructor to this activity.
- Prepare the worksheets for use by the cadets by filling in the title of provincial / territorial legislators; the name of the riding, constituency and municipality; and the title of the appropriate municipal representative.
- Post the following table for the cadets' reference as they complete the activity.

Government	Commonly Discussed Responsibilities	
Federal	<ul style="list-style-type: none"> • National Defence • Foreign Policy • Citizenship • Policing • Criminal Justice • International Trade 	<ul style="list-style-type: none"> • Aboriginal Affairs • International Trade • Immigration (shared) • Agriculture (shared) • Environment (shared)
Provincial and Territorial	<ul style="list-style-type: none"> • Education • Health Care • Natural Resources • Highways • Policing (Ontario, Quebec) 	<ul style="list-style-type: none"> • Aboriginal Affairs • International Trade • Immigration (shared) • Agriculture (shared) • Environment (shared)
Municipal	<ul style="list-style-type: none"> • Social and Community Health • Recycling Programs • Transportation and Utilities 	<ul style="list-style-type: none"> • Snow Removal • Policing • Firefighting

- Gather the required resources:
 - One copy of the job postings worksheets located at Appendix 1 per team, and
 - A pencil and eraser for each team.

ACTIVITY INSTRUCTIONS:

1. Have the cadets select and complete two of the three job posting worksheets located at Appendix 1 (alternatively, if time permits, all three may be completed) by considering what skills / experience the elected representative requires and brainstorming concerns, ideas, and proposals they would like candidates to address in their election platforms.
2. Advise the cadets and ensure that completed postings are consistent with Canadian jurisdictional divisions (as per the table above) and are appropriate and realistic.
3. Discuss with cadets ways in which they may communicate with elected representatives in order to convey their concerns, priorities, and ideas, including writing a letter, signing a petition, and visiting the constituency office.

JOB POSTING FOR CANDIDATE FOR FEDERAL REPRESENTATIVE

SEEKING: CANDIDATES FOR MEMBER OF PARLIAMENT

THE CADETS OF _____ (CORPS /
SQN) ARE SEEKING A MEMBER OF PARLIAMENT TO
REPRESENT _____ (RIDING).

Required Education:

Required Skills:

**IF THE CANDIDATE IS SUCCESSFUL IN THE ELECTION,
THEY WILL HAVE NUMEROUS DUTIES, INCLUDING:**

- Holding the federal government accountable for its work and approve its spending.
- Assisting constituents in using federal government programs, such as:
- Representing the constituents of _____ by bringing their concerns forward, such as:
- Proposing new laws, policies, and ideas, such as:

JOB POSTING FOR CANDIDATES FOR PROVINCIAL / TERRITORIAL REPRESENTATIVE

**SEEKING: CANDIDATES FOR MEMBER
OF _____**

**THE CADETS OF _____ (CORPS / SQN)
ARE SEEKING A MEMBER OF _____ TO REPRESENT
_____ (CONSTITUENCY).**

Required Education:

Required Skills:

**IF THE CANDIDATE IS SUCCESSFUL IN THE ELECTION,
THEY WILL HAVE NUMEROUS DUTIES, INCLUDING:**

- Holding the provincial/territorial government accountable for its work and approve its spending.
- Assisting constituents in using provincial/territorial government programs, such as:
- Representing the constituents of _____ by bringing their concerns forward, such as:
- Proposing new laws, policies, and ideas, such as:

JOB POSTING FOR CANDIDATES FOR MUNICIPAL REPRESENTATIVE

WANTED: CANDIDATES FOR

**THE CADETS OF _____ (CORPS / SQN) ARE SEEKING A
_____ TO REPRESENT _____**

Required Education:

Required Skills:

**IF THE CANDIDATE IS SUCCESSFUL IN THE ELECTION,
THEY WILL HAVE NUMEROUS DUTIES, INCLUDING:**

- Approving the municipal budget and oversee municipal programs.
- Assisting constituents in using municipal government programs, such as:
- Representing the residents of _____ by bringing their concerns forward, such as:
- Proposing new by-laws, policies, and ideas, such as:

THIS PAGE INTENTIONALLY LEFT BLANK

CANADIAN JUSTICE SYSTEM

OBJECTIVE: The aim of this learning station is to familiarize cadets with key elements of the Canadian justice system, and have them consider the role of law and order in Canadian society.

TIME: 30 min

TRAINING LEVEL: 1–4

PRE-ACTIVITY INSTRUCTIONS:

- This activity may be assigned an instructor or be self-directed by the cadets.
- Provide an area large enough for all team members with a table.
- Gather the required resources:
 - The Canadian Justice System Instructions located at Appendix 1 (1 copy per team),
 - The Canadian Justice System – A Brief Overview handout located at Appendix 2 (1 copy per team),
 - Our New Laws template located at Appendix 3 (1 copy per team), and
 - Pens / pencils.
- Post the Canadian Justice System activity instruction sheet on the wall or tape it to the table.
- Place copies of the Canadian Justice System – A Brief Overview and Our New Laws template on the table along with the pens / pencils.

ACTIVITY INSTRUCTIONS:

Have the cadets read and follow the instruction sheet.

THIS PAGE INTENTIONALLY LEFT BLANK

THE CANADIAN JUSTICE SYSTEM

Instructions:

Congratulations! You have just founded your own country. One of the first orders of business is to decide what laws your citizens will be subject to and what consequences, if any, will be imposed when someone breaks the law.

1. Read the brief overview of the Canadian Justice System.
2. As a team, brainstorm answers to the following questions:
 - What laws will your country have?
 - Will they be the same as those in Canada? If not, why not?
 - Will your laws have consequences? If so, what will they be?
3. Create 5 laws and their consequences for your country and write them on the “Our New Laws” template. Your laws can fall under any category.

Things to Think About:

- What would happen in a country that didn't have any laws?
- What would life be like in a country that had severe consequences for people that broke the law?
- Why should the law be different for minors and adults?

THIS PAGE INTENTIONALLY LEFT BLANK

THE CANADIAN JUSTICE SYSTEM

A brief overview...

Understanding the law and the ideas and principles behind it is the responsibility of every Canadian citizen.

Our justice system is based on a long heritage that advocates the rule of law, freedom under the law, democratic principles and due process.

The Canadian justice system is founded on the presumption of innocence. This means that in criminal matters, everyone is presumed innocent until proven guilty.

Canada is governed by an organized system of laws which are intended to provide order, ensure peace and guide our society.

Canadian laws are created by elected representatives and reflect the values and beliefs of citizens.

The law applies to **everyone**, including lawyers, judges and police officers!

Police ensure the safety of citizens and enforce the law. Canada has several types of police which includes municipal, provincial and federal police agencies.

Canada has several types of courts which have been put in place to settle disputes (appeals, criminal, family, traffic, civil, small claims, etc.). The Supreme Court of Canada is the highest court in the country. The Federal Court of Canada deals with matters concerning the federal government.

Lawyers provide advice and assistance on legal matters. If someone cannot afford to hire a lawyer, most communities offer free or low cost legal aid services.

For more information on the Canadian Justice System, visit www.justice.gc.ca

THIS PAGE INTENTIONALLY LEFT BLANK

OUR NEW LAWS

Law	Consequence

THIS PAGE INTENTIONALLY LEFT BLANK

CANADIAN SYMBOLS: TREASURE HUNT

OBJECTIVE: The aim of this learning station is to familiarize cadets with key Canadian symbols.

TIME: 30 min

TRAINING LEVEL: 1–2

PRE-ACTIVITY INSTRUCTIONS:

- Assign an instructor to this learning station. Several assistant instructors may be assigned to help supervise and provide guidance if the cadets are spread out over a large area during the treasure hunt.
- Arrange the use of rooms and hallways around your facility so the cadets can move freely.
- Gather the required resources:
 - Treasure Hunt Set-Up Diagrams located at Appendix 1 (1 copy per instructor),
 - Treasure Hunt Instructions sheet located at Appendix 2 (1 copy),
 - Treasure Hunt Start Here sheet located at Appendix 3 (1 copy),
 - Treasure Hunt Clue sheets located at Appendix 4 (1 copy),
 - Treasure Hunt Secret Word handouts located at Appendix 5 (1 copy per cadet),
 - Treasure Hunt Secret Word Answer Key located at Appendix 6,
 - An orienteering map of your facility, if desired (1 copy per cadet),(this may need to be created),
 - A “treasure” for the cadets, such as canteen gift certificates, fruit, pencils, small hard candies, etc. (1 item per cadet),
 - A timing device such as a stopwatch, and
 - Masking tape.



The treasure hunt can be done either with or without an orienteering map. See an example orienteering map in the Treasure Hunt Set-Up Diagrams located at Appendix 1.

- Post the Canadian Symbols Treasure Hunt Instructions sheet and the Treasure Hunt Start Here sheet at the start point of the treasure hunt.
- If using an orienteering map:
 - Post the decoy clue sheet for each question within the same area as the Clue Sheet with the correct answer.
 - Mark the clue sheets on the map in the correct locations.
- If an orienteering map is not used:
 - Post the three sheets for the first clue (dog, horse and cow) within view of the starting point, but far enough away that the small type cannot be easily read. Place the three animal pictures a few metres apart.
 - Post the correct answer and the decoy clue for each question within view of the clue that leads to them, but again, far enough away that the picture is visible while the words are not. A chart showing the order of the clues is in the Treasure Hunt Set-Up Diagrams at Appendix 1).

- o Provide the instructor at the finish point with a copy of the secret word (HEIRLOOM) and some treasure to distribute to teams as they finish.

ACTIVITY INSTRUCTIONS:

1. Brief the cadets on the treasure hunt and your expectations for their conduct while playing.
2. Distribute Treasure Hunt Secret Word handouts and orienteering maps (if applicable) to each cadet.
3. If multiple teams are playing at the same time, use the stopwatch to start teams on the treasure hunt at 30-second intervals.
4. Provide guidance and supervision as required during the game.
5. As cadets return, check that they have the correct secret word (HEIRLOOM) and, if so, distribute prizes. Each cadet who has completed the sheet gets a prize.
6. If time remains, discuss Canadian symbols with the cadets by asking the following questions:
 - (a) What other national symbols can you think of?
 - (b) Are there other things you think should represent Canada?

TREASURE HUNT SET-UP DIAGRAMS

Sample orienteering map of a cadet
local headquarters training facility:

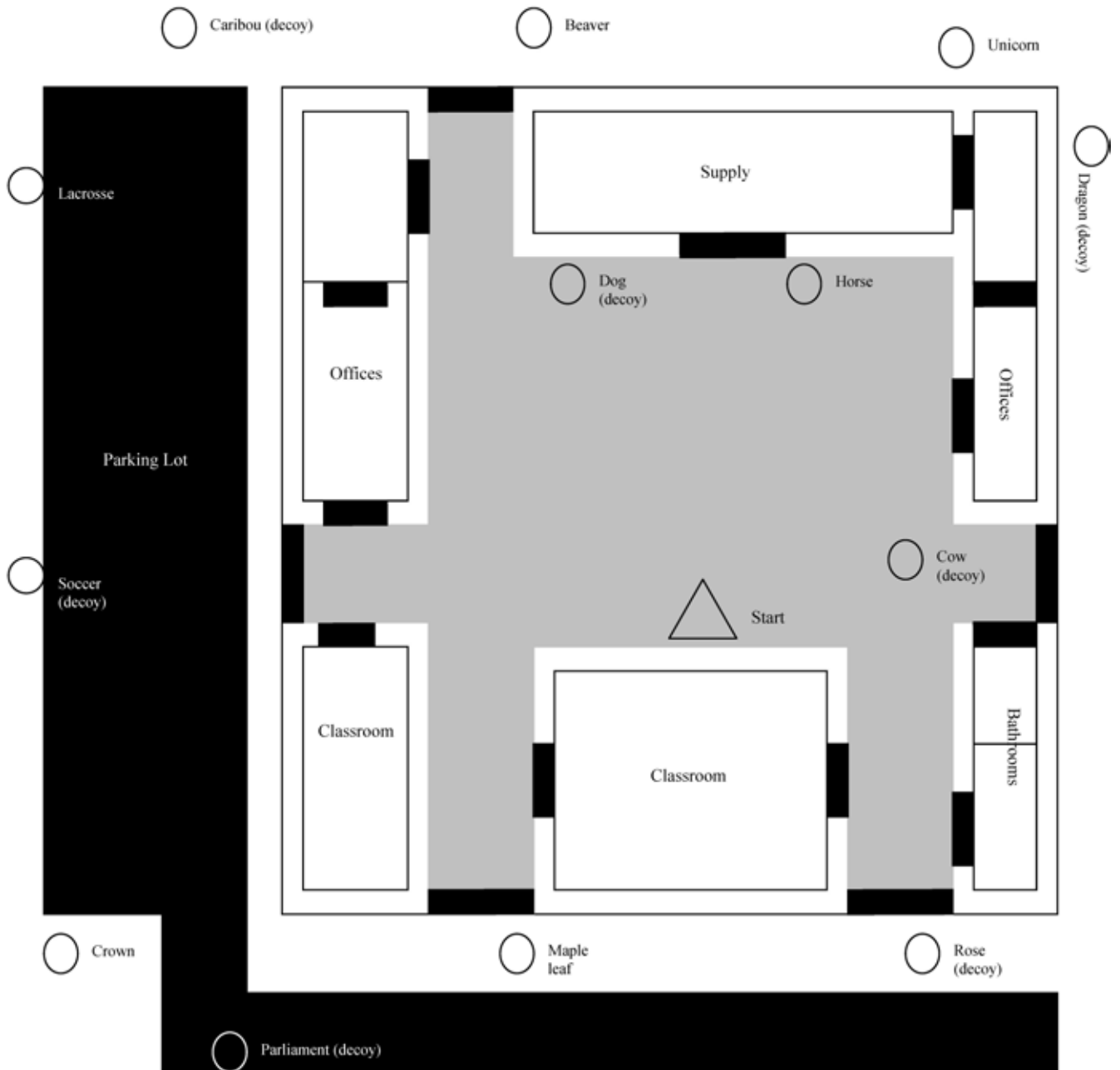

Canadian Symbols Treasure Hunt order of clues:

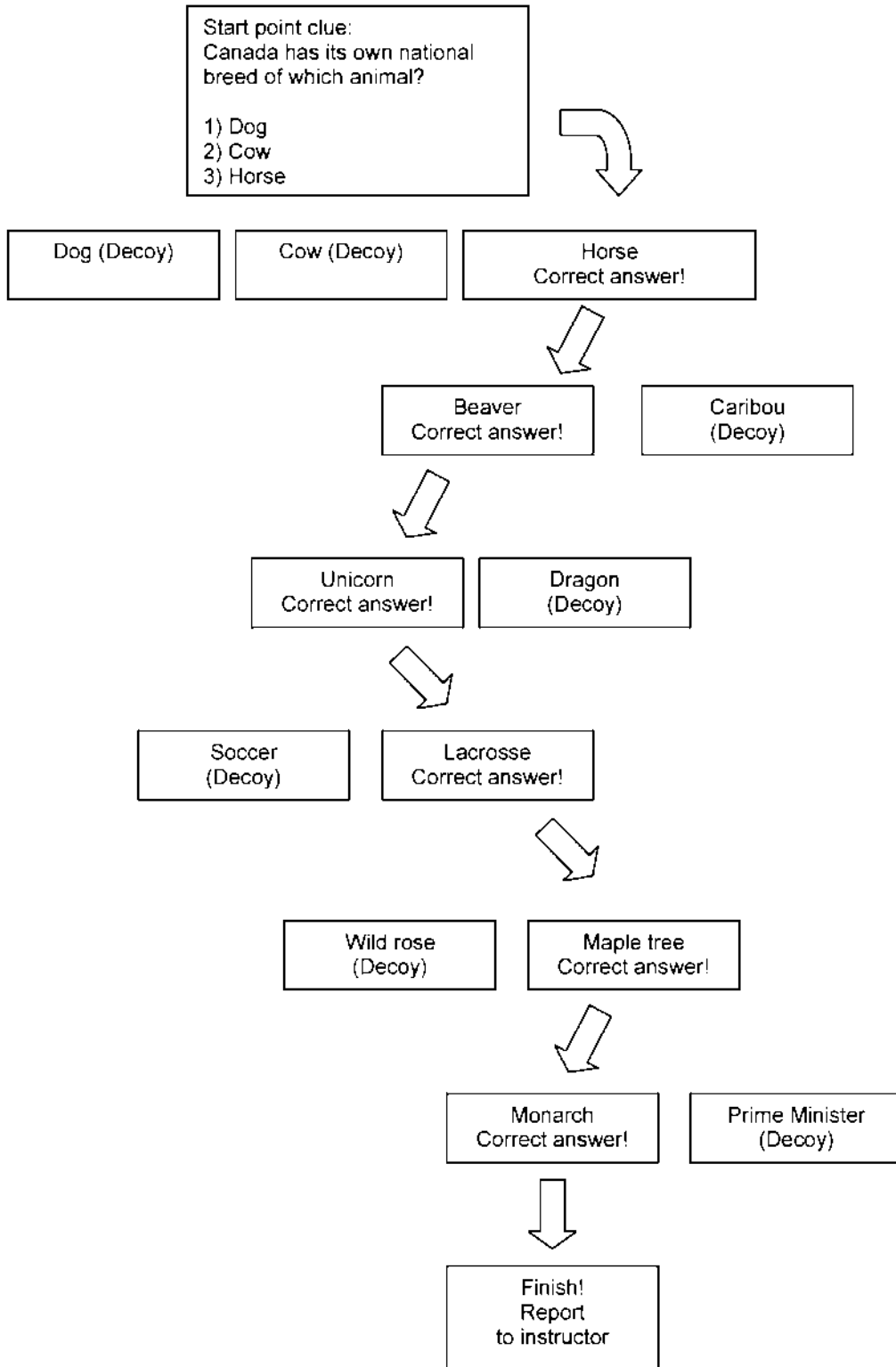

CANADIAN SYMBOLS

Treasure hunt!

Instructions

How well do you know your Canadian symbols? Put your knowledge to the test with this treasure hunt!

1. With your team, find each clue, read it, and guess the correct answer to the question.
2. Every correct answer gives you the next clue in the treasure hunt! But be careful—for every correct answer, there's also one that will lead you astray!
3. Record your answers on the Treasure Hunt handout—the letters in the bubbles spell the secret word when you write them in the spaces at the bottom.
4. When you have all the answers in the right order, take your sheets to the instructor to receive your treasure!



THIS PAGE INTENTIONALLY LEFT BLANK

CANADIAN SYMBOLS

Treasure hunt!

Start Here!

Here's your first clue:

Canada has its own unique national breed of this animal. Is it a:

1. Dog
2. Cow
3. Horse

Find the picture of the correct animal to receive your next clue!

THIS PAGE INTENTIONALLY LEFT BLANK

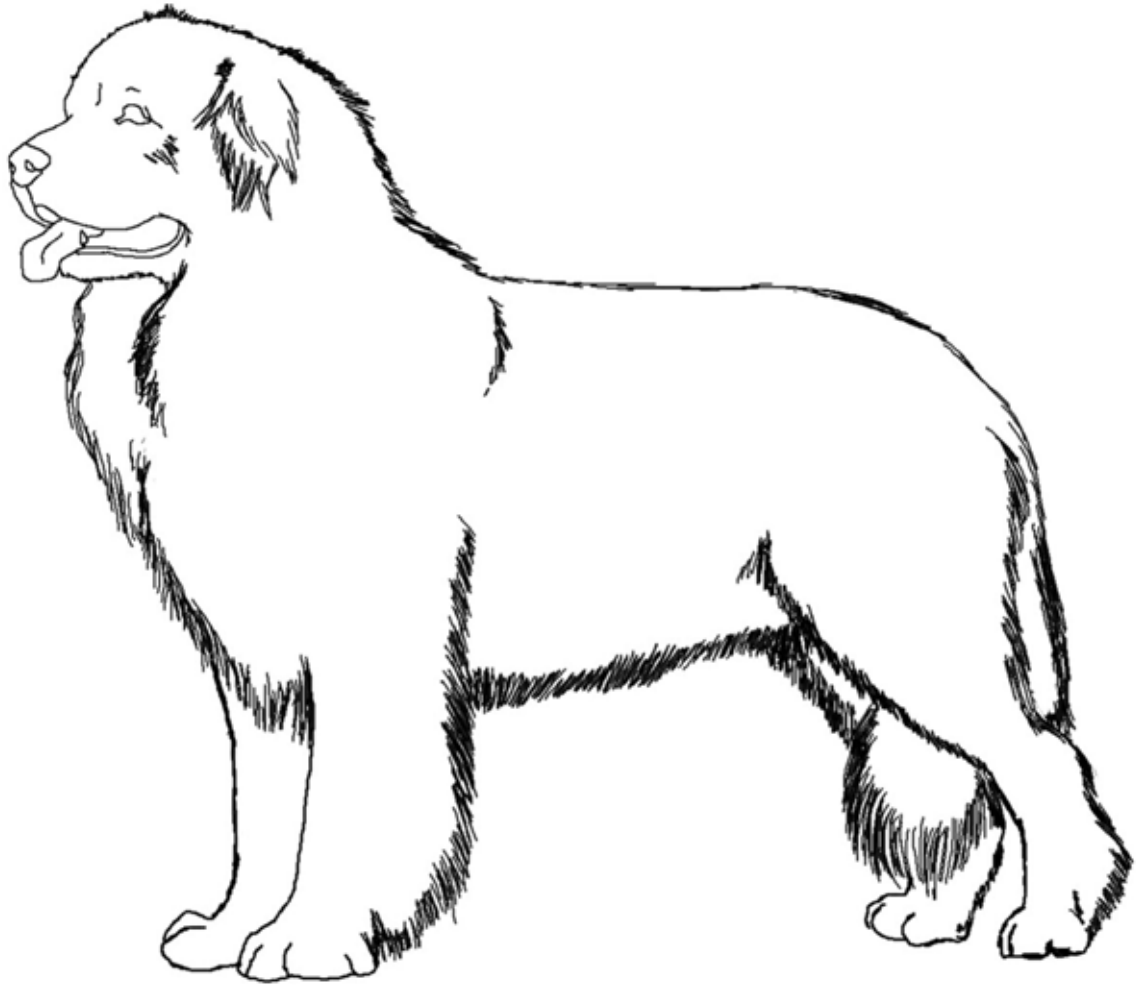

Dog

Sorry! There are several uniquely Canadian breeds of dogs, but we don't have a national breed. Keep trying!

Doggy dog:

Dog dog dog dog dog doggy dog dog dog doggy!

Dog, dog. Puppy. Doggy – dog dog. Dog, dog. Puppy. Doggy – dog dog. Dog doggy dog dog dog:

1. Dog
2. Doggy

Puppy dog dog doggy!

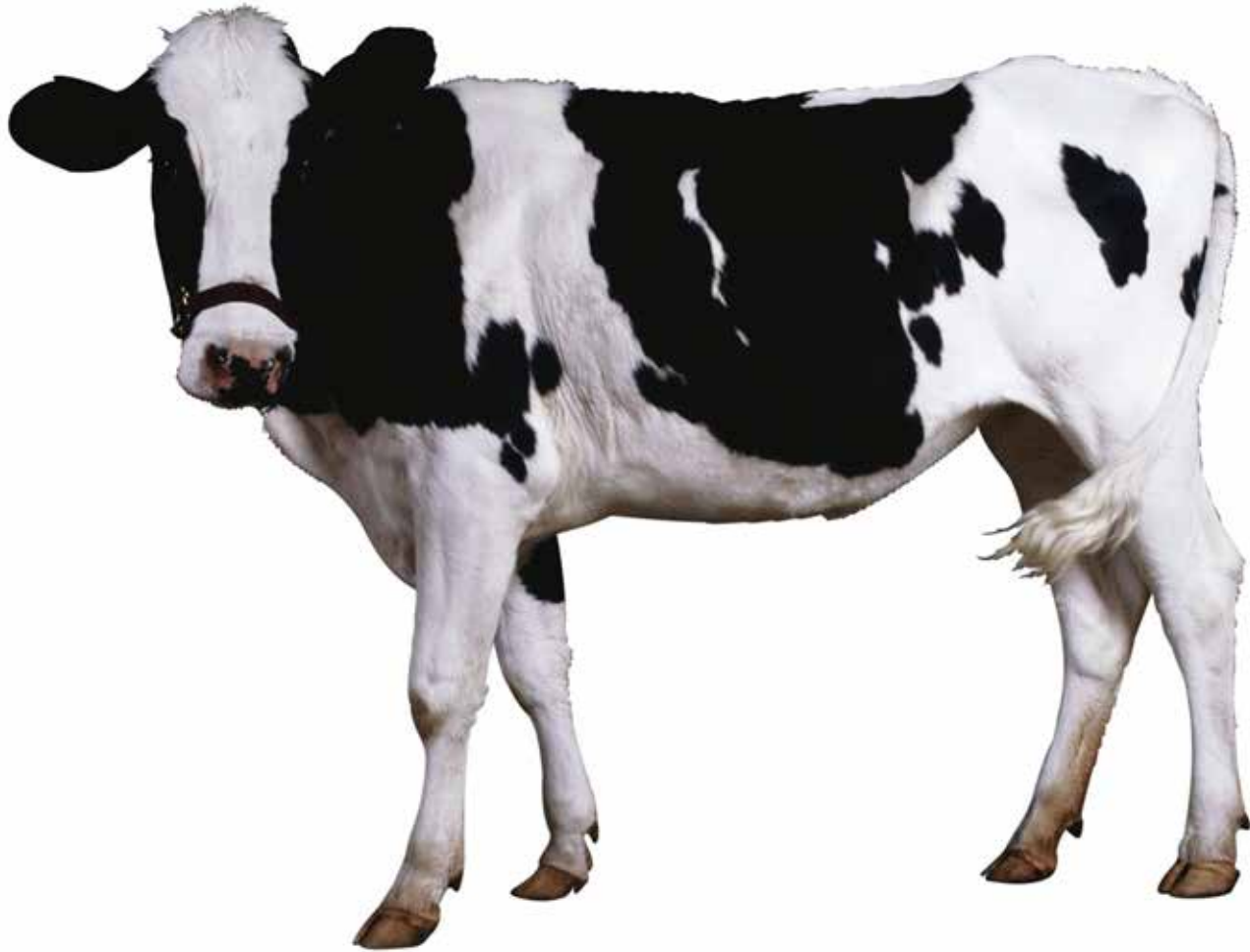

Cow

Sorry! Cows Ice Cream, based in Prince Edward Island, is a Canadian company, but there is no national breed of cow. Keep trying!

Moo cow bull:

Cow cow cow cow cowie. Cows cows cows bull cows!

Cow, cow. Moo. Cowie – cow bull:

1. cow
2. bull

Cowie cow bull cow moo!

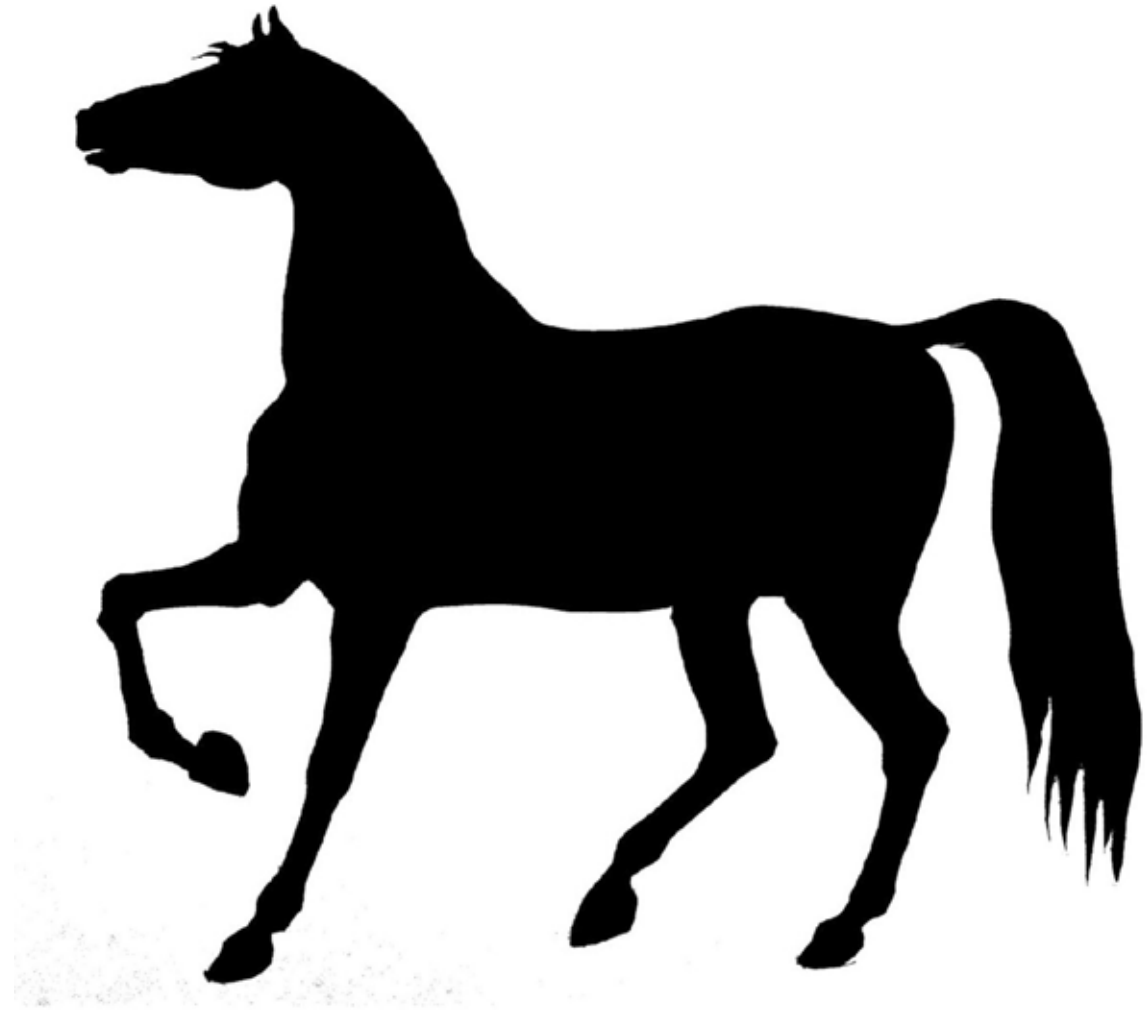

Horse

You got it! Our unique Canadian horses are known for their strength, resilience, intelligence and good temper. They can trace their lineage back to the Royal Stables of the King of France!

Next Clue:

The tradition of using the word “buck” to mean a dollar came from this symbolic Canadian animal, used in making hats, because the Hudson’s Bay Company would pay one “buck” (a special coin) for its hide. Is it a:

1. Caribou
2. Beaver

Find its picture to get another clue!

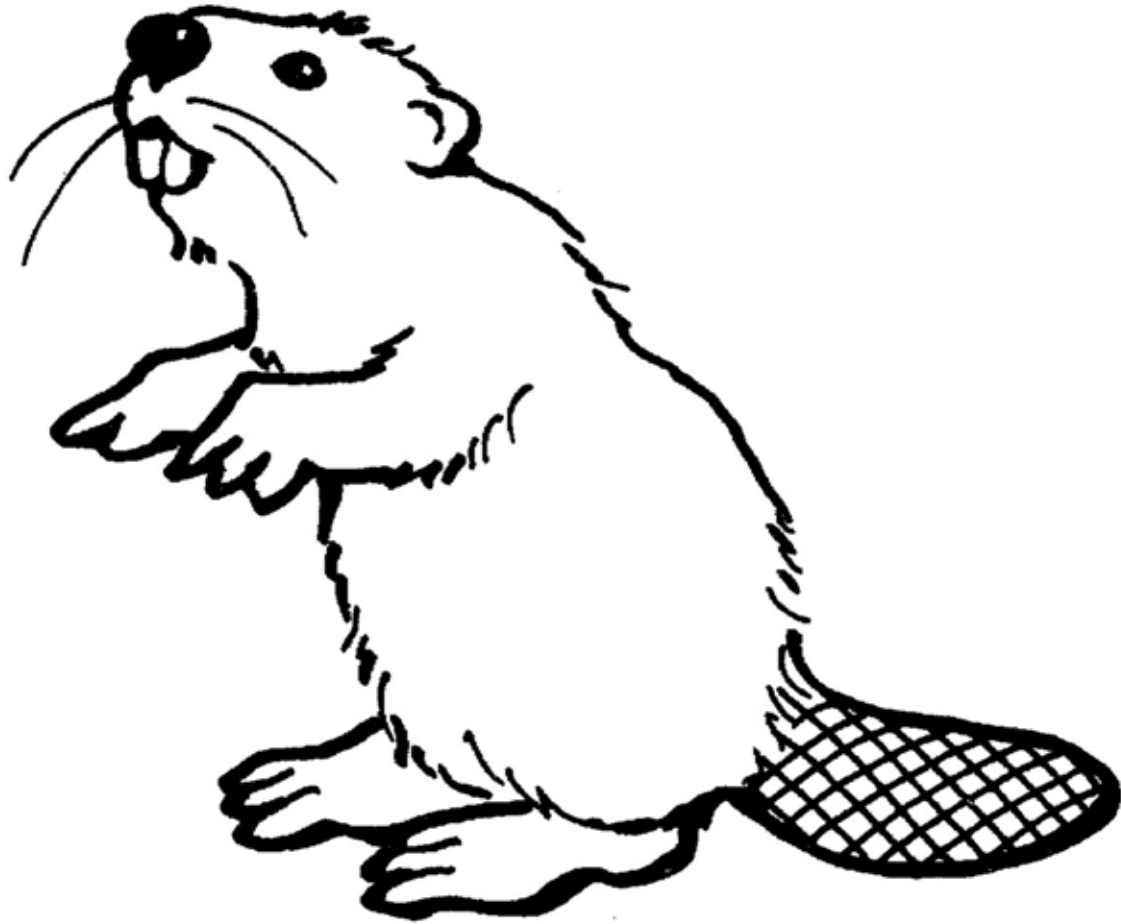

Beaver

Way to go! Fur hats were all the rage in 18th-century Europe. Beavers also represent the hard-working, industrious and community-oriented spirit of Canadians.

Next Clue:

The Canadian coat of arms is supported by two animals, a golden lion which represents England, and this mythical creature that represents Scotland. Is it the:

1. Unicorn
2. Dragon

Find its picture to get another clue!

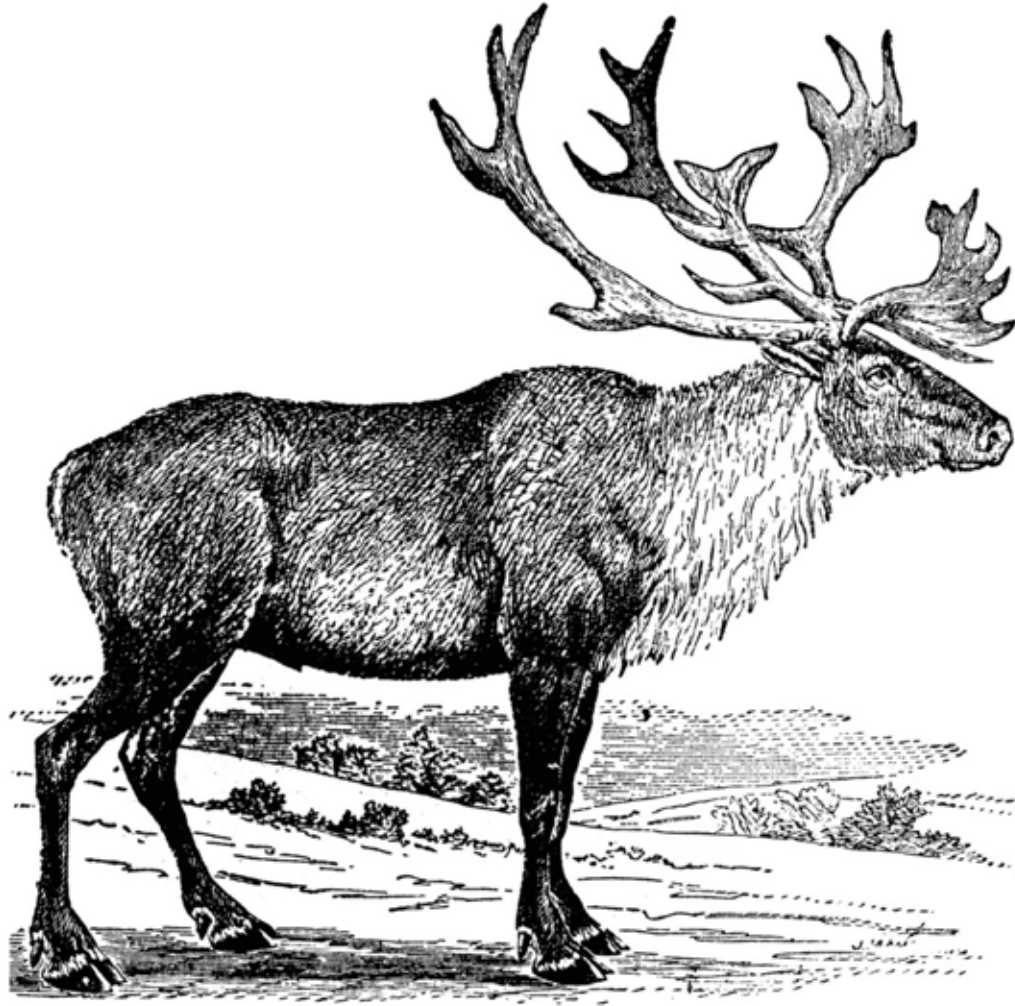

Caribou

Sorry! The caribou is considered a Canadian symbol, but it's not the one you're looking for. Keep trying!

Caribou caribou:

Caribou caribou caribou caribou caribou caribou caribou caribou caribou!

Caribou, caribou. Caribou. Caribou – caribou caribou :

1. Caribou
2. Caribou too

Caribou caribou caribou bou!



Unicorn

Great job! The unicorn on the coat of arms has a coronet around its neck with a broken chain. The broken chain symbolizes Canadians' resistance to oppression.

Next Clue:

Canada's national winter sport is hockey, but what is our national summer sport?

1. Soccer
2. Lacrosse

Find its picture to get another clue!

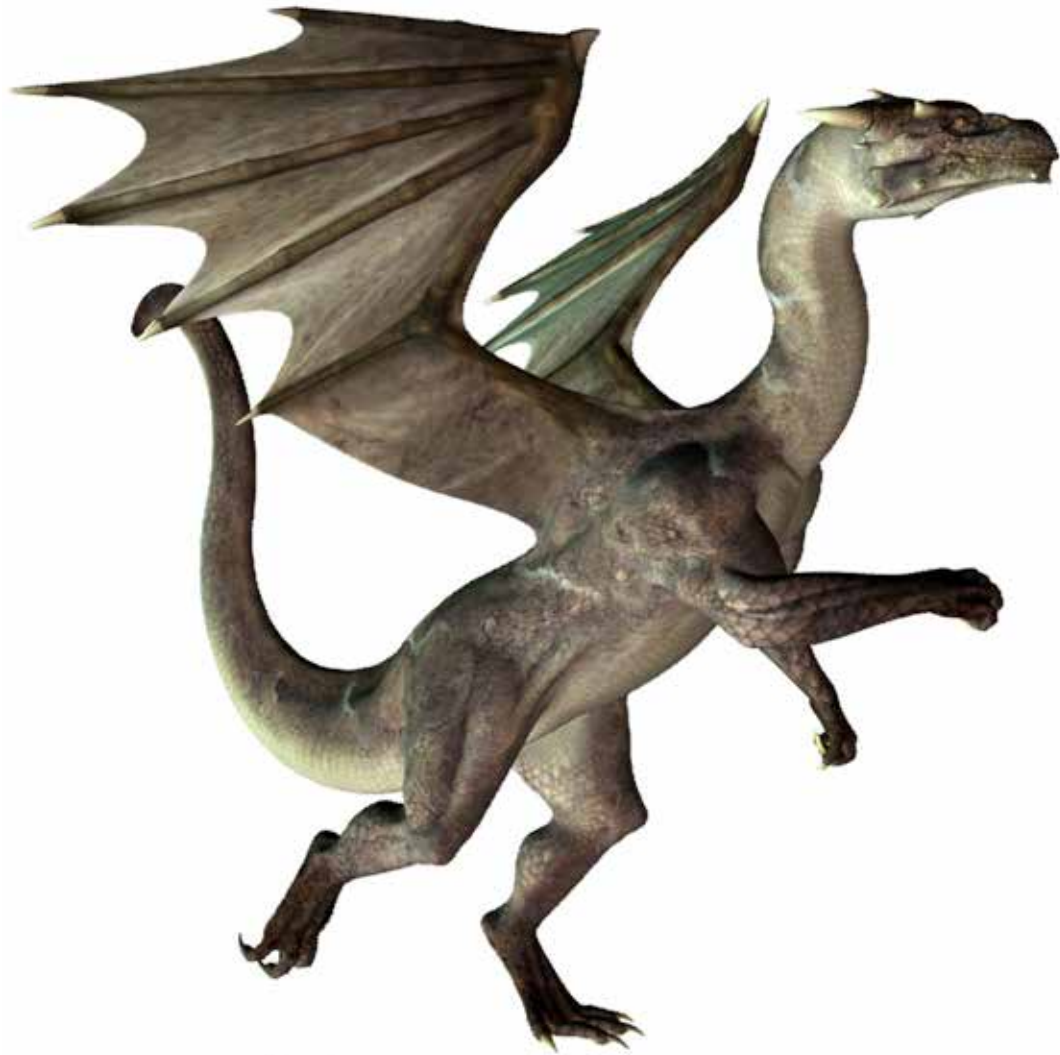

Dragon

Sorry, brave knights. There are no dragons in Canada—
if there were, they would melt all the snow. Keep trying!

Dragon dragon:

Dragon dragon dragon, dragon fire dragon – sparks. Dragon dragon.

Dragon-fire. Dragon, dragon dragon:

1. Fire
2. Scales

Dragon dragon scales!



Lacrosse

Correct! Lacrosse is a traditional Canadian Aboriginal sport that has been around for hundreds of years. Now it's played competitively all over the world.

Next Clue:

Which is Canada's national floral or arboreal emblem?

1. Maple tree
2. Wild rose

Find its picture to get another clue!



Soccer

Sorry! Canada has some great soccer players, but it's not our national sport. Keep trying!

Soccer ball:

Soccer soccer soccer ball. Net ball. Soccer footie soccer soccer. Net, soccer ball net. Net ball soccer net:

1. soccer
2. footie

Soccer net soccer ball!

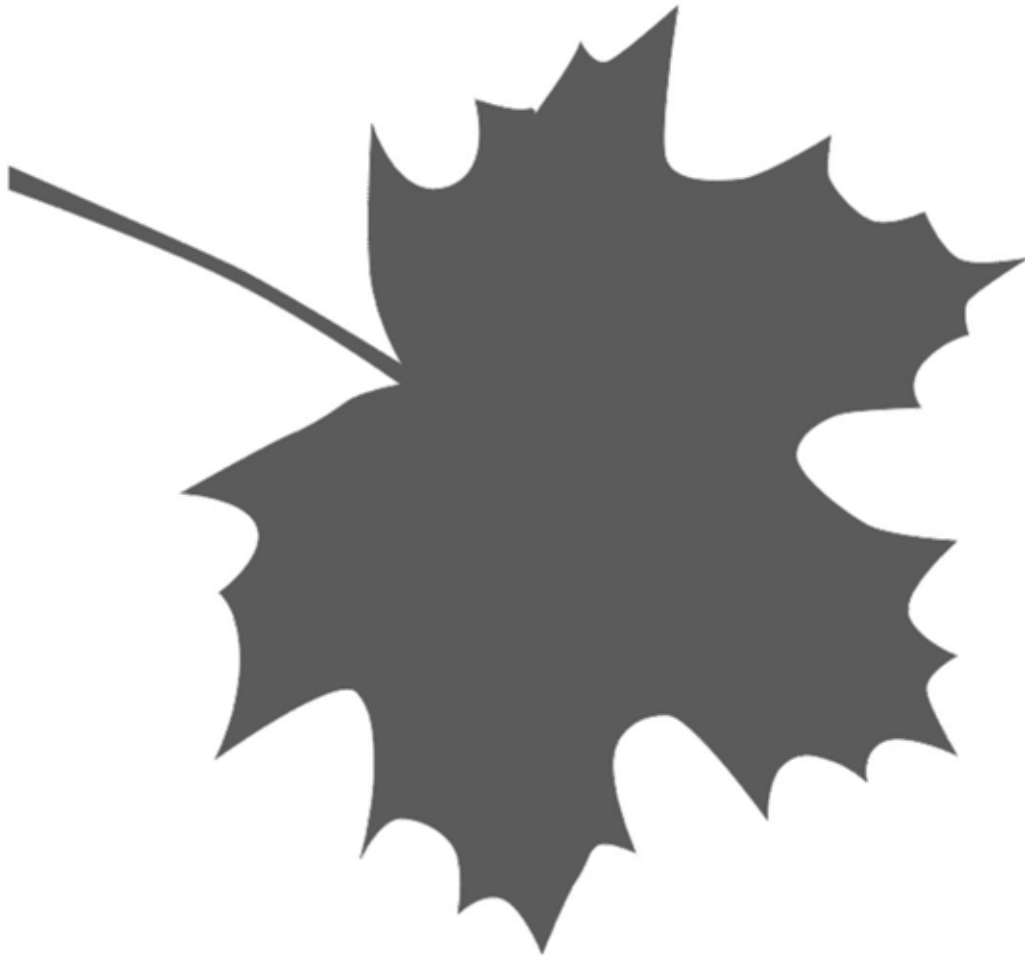

Maple Tree

Correct answer! People in Canada have been enjoying maple syrup for centuries, and the maple leaf has long been used as a symbol for our country. It officially became our arboreal emblem in 1996.

Next Clue:

Whenever you salute an officer, you are actually saluting the authority of this person.

Who is it?

1. Prime Minister of Canada
2. King or Queen of Canada

Find this person's symbol to finish the treasure hunt!



Prime Minister

Sorry! The Prime Minister is our national leader and representative in Ottawa, but officially the commission held by a Canadian Armed Forces officer comes from someone else. Saluting is a really old tradition!

Parliament parliament:

O Canada our home and native land, true patriot love, in all our son's command...

Parliament parliament house of commons:

1. Ottawa
2. Canada

O Canada Canada!



Monarch

Great work! Each officer in the Canadian Armed Forces receives a commissioning scroll signed by the Monarch's representative in Canada, the Governor General. The symbol of the Monarch is the crown, which is incorporated into many of our national, provincial and military symbols.

Congratulations!

**You have finished the treasure hunt!
Report back to your instructor to show off what you've learned!**

TREASURE HUNT SECRET WORD SHEET

As you find the answer to each clue, write it in the spaces here. The gray boxes are letters that spell the secret word! Take this sheet back to your instructor when you finish the treasure hunt to receive your prize!

1.													
2.													
3.													
4.													
5.													
6.													

 O **M**

Secret word

Place the letters from the shaded squares here to find the secret word!

THIS PAGE INTENTIONALLY LEFT BLANK

TREASURE HUNT SECRET WORD ANSWER KEY

1.	H	O	R	S	E						
2.	B	E	A	V	E	R					
3.	U	N	I	C	O	R	N				
4.	L	A	C	R	O	S	S	E			
5.	M	A	P	L	E		T	R	E	E	
6.	M	O	N	A	R	C	H				

Secret word: HEIRLOOM

THIS PAGE INTENTIONALLY LEFT BLANK

CANADIAN SYMBOLS: COAT OF ARMS CHALLENGE

OBJECTIVE: The aim of this learning station is to familiarize cadets with the components of Canada's coat of arms and appreciate its role as a national symbol.

TIME: 30 min

TRAINING LEVEL: 3–4

PRE-ACTIVITY INSTRUCTIONS:

- This activity may be assigned an instructor or be self-directed by the cadets.
- Gather the required resources:
 - Coat of Arms Challenge sheet located at Appendix 1 (1 copy),
 - About Our Coat of Arms handout located at Appendix 2 (1 per cadet),
 - Coat of Arms Challenge worksheet located at Appendix 3 (1 per cadet),
 - Coat of Arms Template located at Appendix 4 (1 per cadet),
 - Masking tape,
 - Pencils and erasers,
 - Pencil crayons or markers and other art supplies (stickers, rubber stamps, etc.), and
 - Pencil sharpener.

ACTIVITY INSTRUCTIONS:

Have the cadets read and follow the instruction sheet.

THIS PAGE INTENTIONALLY LEFT BLANK



COAT OF ARMS CHALLENGE

A coat of arms was originally a symbol that warriors painted on their shields to identify themselves and bring them protection in battle.

Today, a country's coat of arms symbolizes the values and history of that country and identifies them to the world.

Imagine that you have just founded a new country. Your mission is to design a coat of arms to represent your country to the world. Each member of the team should make their own, but you can discuss your decisions with teammates.

1. Read the About Our Coat of Arms handout to familiarize yourself with the parts of the coat of arms and what they mean.
2. Choose appropriate symbols for your own coat of arms and write them in the correct spaces on the Coat of Arms worksheet. Be sure to explain what each symbol represents in the space provided.
3. Draw your new coat of arms and post it on the wall for the rest of the cadets to see!

THIS PAGE INTENTIONALLY LEFT BLANK

ABOUT OUR COAT OF ARMS

Check out this information from the Canadian heritage page (www.pch.gc.ca) to find out about our Canadian coat of arms.

The shield



The design of the arms of Canada reflects the royal symbols of Great Britain and France (the three royal lions of England, the royal lion of Scotland, the royal *fleurs-de-lis* of France and the royal Irish harp of Tara). On the bottom portion of the shield is a sprig of three Canadian maple leaves representative of Canadians of all origins.

The three royal lions of England

The first quarter consists of the three gold lions of England walking and shown full face, on a red background. The lion is the oldest device known in heraldry and, as "king of beasts", was adopted by kings of Leon, Norway and Denmark as their emblem. However, the origin of the three royal lions of England still remains a mystery.

In the 11th century, Henry I, known as "the lion of justice", may have been the first English king to use a lion. It is uncertain as to why a second lion suddenly appeared. When Henry II married Eleanor of Aquitaine, whose family emblem was also a lion, it is believed that he added the third lion. There is no question that, when he led his English troops in the Crusades, Richard I, "the Lion-Hearted" carried a shield emblazoned with three golden lions on a red background. To this day they have been the royal symbol of England.

The royal lion of Scotland

The second quarter consists of a red lion rearing on the left hind foot, within a red double border with *fleurs-de-lis*, on a gold background. The royal lion of Scotland was probably first used by King William, who was known as "the lion". However it was certainly used by his son, Alexander III, who made Scotland an independent nation.

The royal Irish harp of Tara

The third quarter is a gold harp with silver strings, on a blue background. North of the present city of Dublin, there is a hill called Tara which for centuries was the religious and cultural capital of ancient Ireland. If you visit the site, you will see a 750 foot earthen work that is said to have been the site of the banqueting hall of Irish kings. Thomas Moore recalls the history of this site in one of the most famous of all Irish lyrics that begins: "The harp that once through Tara's hall the soul of music shed..." There is a legend, recorded in C.W. Scott-Giles monumental work *The Romance of Heraldry*, that this harp was found and came into the possession of the pope. In the 16th century, Henry VIII suppressed the Irish people in his attempt to become the lawful successor to the kings of ancient Ireland. The pope sent the harp of Tara to England whereupon Henry added its likeness to his royal shield. From this time it has remained a symbol of Ireland.

The royal *fleurs-de-Lis* of France

The fourth quarter depicts three gold *fleurs-de-lis*, on a blue background. The *fleurs-de-lis* was the first heraldic emblem raised in Canada. On July 24, 1534, Jacques Cartier landed at *Gaspé* and erected a cross, affixed with the symbol of his sovereign and the royal house of France.

The three maple leaves

To complete the design of the shield, a Canadian symbol was required. Three red maple leaves conjoined on one stem, on a silver or white background, were then added. Throughout the 19th century, the maple leaf had gradually become closely identified with Canada. The maple leaf had been worn as a symbol of Canada during the visit of the Prince of Wales in 1860. The song "The Maple Leaf Forever", written by the Toronto school teacher Alexander Muir in 1868 had become Canada's national song. During World War I, the maple leaf was incorporated into the badge of many Canadian regiments. It was most appropriate that three maple leaves were given a commanding position within the shield, which made it unmistakably "Canadian".

The ribbon



On the advice of the Prime Minister of Canada, Her Majesty The Queen approved, on July 12, 1994 that the arms of Canada be augmented with a ribbon with the motto of the Order of Canada: "*Desiderantes Meliorem Patriam*". (They desire a better country).

The helm and the mantling



The helm (*heaume* or helmet), which in heraldry is usually placed above the shield of arms, not only serves as a means of displaying the crest, but also has a significance of its own, since its type denotes the rank of the person bearing the arms. On the helm lies a mantling or lambrequin. The mantle, originally, was to protect the head and shoulders of the wearer from the sun's heat. It has become a decorative accessory to the crest and shield.

The arms of Canada show a royal helmet, which is a barred helm of gold looking outward and draped in a mantle of white and red which are the official colours of Canada.

The crest



On the royal helmet is the crest. This symbol consists of a wreath or ring of twisted white and red silk on which stands a crowned gold lion holding in its right paw a red maple leaf. The lion is a symbol of valour and courage.

The crest is used to mark the sovereignty of Canada. It is now the symbol used on the Governor General's Standard.

The supporters



The figures that stand on either side of the shield are known in heraldry as "supporters" and are often depicted in a ferocious manner. The King of England chose two lions while Scotland chose two unicorns.

When James VI of Scotland became James I of England in 1603, he chose one lion and one unicorn as the supporters of his royal shield. Canada adopted the same pattern and used a lion on the shield's left holding a gold pointed silver lance from which flies the Royal Union flag, and a unicorn with gold horn, mane and hoofs, on the shield's right. Around its neck is a gold and chained coronet of crosses and *fleurs-de-lis*. The unicorn holds a lance flying a banner of royalist France, namely three gold *fleurs-de-lis*, on a blue background. The two banners represent the two principal founding nations that had established Canada's most enduring laws and customs.

The motto



Canada's motto "*A Mari usque ad Mare*" (From sea to sea) is based on biblical scripture: "He shall have dominion from sea to sea and from the river unto the ends of the earth (From Sea to sea) – Psalm 72:8". The first official use of this motto came in 1906 when it was engraved on the head of the mace of the Legislative Assembly of the new Province of Saskatchewan. The wording of the motto came to the attention of Sir Joseph Pope, then Under Secretary of State, who was impressed with its meaning. He later proposed it as motto for the new design of the coat of arms, which was approved by Order in Council on April 21, 1921 and by Royal Proclamation on November 21, 1921.

The four floral emblems



At the base of the arms are the floral emblems associated with the Canadian Monarchy: the English rose, the Scottish thistle, the French *fleur-de-lis* and the Irish shamrock.

- **English rose** - The rose first became the symbol of England when Henry III married Eleanor of Provence and the golden rose of Provence became England's new floral symbol. From this golden rose eventually came the red rose of the House of Lancaster and the white rose of the House of York.

- **Scottish thistle** - There is a legend that, in 1010 when they attempted to capture Scotland, the Danes landed secretly at night. As they approached Stains Castle they removed their shoes to avoid making any noise. When they reached the castle's moat, they jumped in not realizing that the moat was dry and overgrown with thistles. The screams of the bare-footed Danes roused the garrison. The castle and Scotland were both saved and, according to legend, it is in memory of that night that the thistle became the floral emblem of Scotland.
- **Irish shamrock** - In Irish legends, it is said that when he brought Christianity to Ireland, Saint Patrick used the three petals of the shamrock to illustrate the Holy Trinity. As a result, the shamrock became the floral emblem of Christian Ireland.
- **The French *fleurs-de-Lis***- Following its adoption as the symbol of France's king, the *fleurs-de-lis* also became the symbol of Christian France. By the 13th and 14th centuries, the three petals of the lily of France were being described by writers as symbols of faith, wisdom and chivalry. As in Ireland, they also came to be seen as symbols of the Holy Trinity.

The imperial crown



On top of the "achievement of the arms of Canada" is the imperial crown which is indicative of the presence of a monarch as Canada's Head of State.

The shapes of symbols in a coat of arms can be altered by an artist since heraldry is an art as well as a science. However the symbols themselves can never be changed without formal approval. In 1957, when Canada's arms were slightly modified to produce a cleaner more contemporary design, the Government replaced the original Tudor crown of the 1921 design by a crown that would represent not just one of the royal families of English monarchs, but centuries of kings and queens of England. In accordance with the expressed wishes of Her Majesty Queen Elizabeth II, the Saint Edward's crown is now used for the arms of Canada. It is this crown that has been used for the coronation of kings and queens in Westminster Abbey for centuries.

COAT OF ARMS CHALLENGE

WORKSHEET

Part of the coat of arms	What you chose	What it represents
Colours and patterns on the Shield		
Motto for your new country		
Items in the Helm		
Animal on the Crest (on top)		
Supporter 1		
Supporter 2		
Floral emblems		
Crown or other symbol of government or allegiance		
Other symbols you choose to incorporate into your country's coat of arms		

THIS PAGE INTENTIONALLY LEFT BLANK

COAT OF ARMS OF THE NATION OF



THIS PAGE INTENTIONALLY LEFT BLANK

CANADA'S ECONOMY

OBJECTIVE: The aim of this learning station is to familiarize cadets with key aspects of Canada's economy and consider ongoing economic issues.

TIME: 30 min

TRAINING LEVEL: 1–4

PRE-ACTIVITY INSTRUCTIONS:

- This activity is self-directed by the cadets.
- Provide a quiet area large enough for all team members with a table and chairs.
- Gather the required resources:
 - Canada's Economy activity instruction sheet located at Appendix 1 (1 copy per team),
 - Canada's Economy overview located at Appendix 2, and
 - Canada's Economy worksheet located at Appendix 3 (1 per cadet).
- Post the Canada's Economy activity instruction sheet on the wall or tape it to the table.
- Place copies of Canada's Economy overview and worksheet on the table.

ACTIVITY INSTRUCTIONS:

Have the cadets read and follow the Canada's Economy activity instruction sheet.

THIS PAGE INTENTIONALLY LEFT BLANK

CANADA'S ECONOMY

INSTRUCTIONS:

1. List what you already know about Canada's Economy and "Pair-Share" your knowledge with another person on your team.
2. Read the brief overview on Canada's Economy.
3. Answer each of the questions on the worksheet. Your answers don't have to be written out in full; they can be in point form. There are no "right" answers but your answers should be well thought out and supported.
4. You have 30 minutes to complete this activity.

Things to consider:

- Which industry do you think is most prevalent in your region?
- What have you learned about Canada's Economy that you didn't know before?
- Which industry are you most likely to go into when you finish school?

THIS PAGE INTENTIONALLY LEFT BLANK

CANADA'S ECONOMY OVERVIEW

A Trading Nation

Canada has always been a trading nation and commerce remains the engine of economic growth. As Canadians, we could not maintain our standard of living without engaging in trade with other nations.

In 1988, Canada enacted free trade with the United States. Mexico became a partner in 1994 in the broader North American Free Trade Agreement (NAFTA), which created the world's largest free trade area, which now links over 450 million people producing \$17 trillion worth of goods and services as of 2012.

Today, Canada has one of the ten largest economies in the world and is part of the G8 group of leading industrialized countries with the United States, Germany, the United Kingdom, Italy, France, Japan and Russia.

Canada's Economy Includes Three Main Types of Industries:

Service industries provide thousands of different jobs in areas like transportation, education, health care, construction, banking, communications, retail services, tourism and government. More than 75% of working Canadians now have jobs in service industries.

Manufacturing industries make products to sell in Canada and around the world. Manufactured products include paper, high technology equipment, aerospace technology, automobiles, machinery, food, clothing and many other goods. Our largest international trading partner is the United States.

Natural resources industries include forestry, fishing, agriculture, mining and energy. These industries have played an important part in the country's history and development. Today, the economy of many areas of the country still depends on developing natural resources, and a large percentage of Canada's exports are natural resources commodities.

Canada – US Relations

Canada enjoys close relations with the United States and each is the other's largest trading partner. Over three-quarters of Canadian exports are destined for the U.S.A. In fact we have the biggest bilateral trading relationship in the world. Integrated Canada-U.S.A. supply chains compete with the rest of the world. Canada exports billions of dollars worth of energy products, industrial goods, machinery, equipment, automotive, agricultural, fishing and forestry products, and consumer

goods every year. Millions of Canadians and Americans cross every year freely in what is traditionally known as “the world’s longest undefended border.”

At Blaine in the State of Washington, the Peace Arch, inscribed with the words “children of a common mother” and “brethren dwelling together in unity,” symbolizes our close ties and common interests.

3. Canada is rich in natural resources such as oil, gas, energy, fresh water, lumber, fishing, agricultural products etc. The potential exists that in the future these resources could become scarce or even run out. At what point, if any, should Canada limit the amount of natural resources that are sold to other countries and why?
4. Should Canada rely more on natural resources as a source of income or focus on developing other manufacturing industries to boost / sustain our economy? What industries should Canada focus on developing in future?
5. What Canadian brands can you think of? What products do you own that are made in Canada?

CANADA'S REGIONS: SYMBOLS MAP

OBJECTIVE: The aim of this learning station is to familiarize cadets with the regions of Canada and their characteristics.

TIME: 30 min

TRAINING LEVEL: 1–2

PRE-ACTIVITY INSTRUCTIONS:

- This activity may be assigned an instructor or be self-directed by the cadets.
- Provide an area large enough for all team members with a table and ample wall space to display the map of Canada.
- Gather the required resources:
 - Regional Symbols activity instruction sheet located at Appendix 1 (1 copy),
 - Map of Canada's Regions located at Appendix 2,
 - Canada's Regions Sheets located at Appendix 3 (1 set),
 - Canada's Regions - Symbols and Place Names located at Appendix 4 (2 sets),
 - Canada's Regions - Symbols answer key located at Appendix 5 (1 copy), and
 - Masking tape.
- Cut two sets of the Canada's Regions Symbols and one set of place names into individual cards, and place them on the table.
- Post the Canada's Regions activity instruction sheet on the wall or tape it to the table.
- Post the Map of Canada's Regions on the wall or place it on the table.
- Either post the Canada's Regions Sheets on the wall or place them on a table. Alternatively, a large map may be used.

ACTIVITY INSTRUCTIONS:

Have the cadets read and follow the Canada's Regions activity instruction sheet.

THIS PAGE INTENTIONALLY LEFT BLANK

REGIONAL SYMBOLS INSTRUCTIONS:

Canada has **five** distinct regions that include many different geographical areas. Even with the diversity of region, many things are similar across the country.

1. Place the province and capital city names on the map.
2. As a team, discuss and determine which symbols belong to each region.
3. Place each of the cut-outs on either the appropriate regional sheet or a large map of Canada (if available). Keep in mind that some of the symbols may belong to more than one region.
4. If your team is uncertain about where to place a symbol, try to figure it out using what you already know about Canada and what makes the most sense (eg, polar bears live in the north).
5. You have 30 minutes to complete this activity.
6. Check the answer key to see how many you got correct.

Things to consider:

- Which regions have you visited? How are they different from your own?
- What have you learned about your own region that you didn't know before?
- What have you learned about the other regions that you didn't know before?

THIS PAGE INTENTIONALLY LEFT BLANK

CANADA'S REGIONS

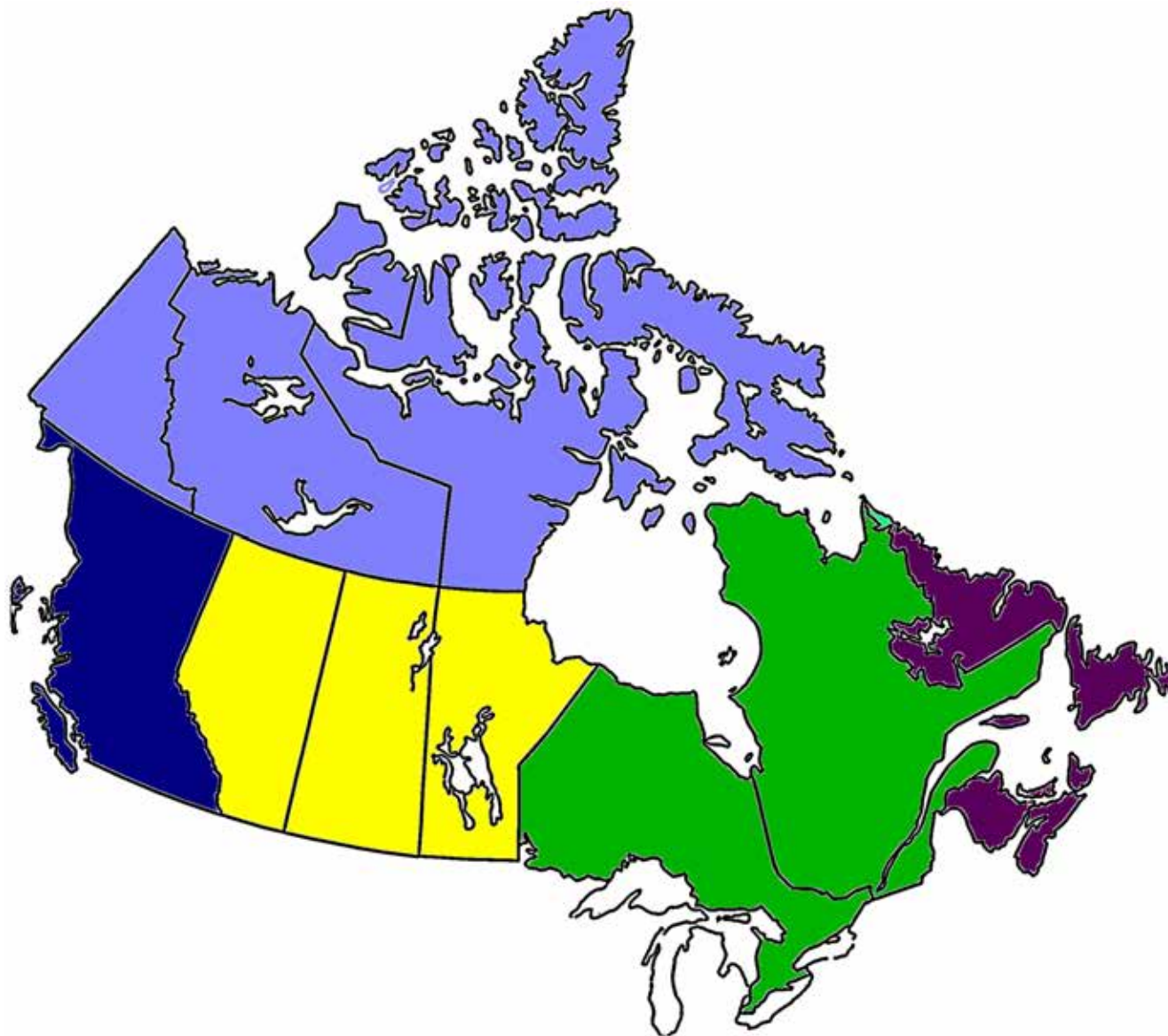

THIS PAGE INTENTIONALLY LEFT BLANK

CANADA'S REGIONS
ATLANTIC

CANADA'S REGIONS
CENTRAL

CANADA'S REGIONS
PRAIRIE

CANADA'S REGIONS
WEST COAST

CANADA'S REGIONS
NORTHERN

THIS PAGE INTENTIONALLY LEFT BLANK

CANADA'S REGIONS SYMBOLS



Igloo



Film Industry



Polar Bear



Salmon



Oil Drill



Off-Shore Oil Rig



Inuksuk



Potatoes



Mountain



Wheat



Gold Miner



Moose



Forestry



CN Tower



Cowboy



Lumberjack



Orca



Fishing Boat



Viking Hat



Hydro Dam



Anne of Green Gables



Farm



Freighter



Celtic cross



Fleur de lis



Gold



Mining



Wine Industry



Fruit



Dairy



Caribou



Freshwater fishing



Dogsled



RCMP



Ukrainian Egg



Natural Gas



Totem Pole



Fireweed

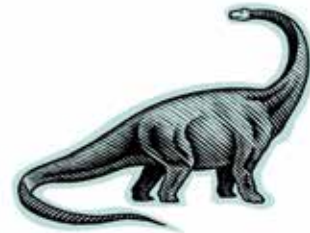

Dinosaur



Cattle Drive



Tepee



Seal



Diamond



Apple



Submarine



Parliament



Chinatown



Confederation Bridge



Iceberg



Lighthouse



Lobster



Maple Syrup



Niagara Falls



Buffalo

Canada's regions

Capital Cities & Provinces / Territories

<i>Ontario</i>	<i>Quebec</i>
<i>Prince Edward Island</i>	<i>Alberta</i>
<i>Yukon</i>	<i>Northwest Territories</i>
<i>Nova Scotia</i>	<i>New Brunswick</i>
<i>Manitoba</i>	<i>St. John's</i>
<i>Halifax</i>	<i>Fredericton</i>
<i>Toronto</i>	<i>Winnipeg</i>
<i>Edmonton</i>	<i>Victoria</i>
<i>Fellowknife</i>	<i>Whitehorse</i>
<i>Manitoba</i>	<i>Saskatchewan</i>
<i>British Columbia</i>	<i>Charlottetown</i>
<i>Newfoundland and Labrador</i>	<i>Quebec City</i>
<i>Regina</i>	<i>Iqaluit</i>
<i>Ottawa</i>	<i>Prairie</i>
<i>Atlantic</i>	<i>Central</i>
<i>West Coast</i>	<i>Northern</i>

THIS PAGE INTENTIONALLY LEFT BLANK

CANADA'S REGIONS ANSWER KEY

From the information below, determine if your team has placed the symbols in the correct regions.

Canada has five distinct regions:

The Atlantic Provinces	<ul style="list-style-type: none"> • Newfoundland and Labrador • Prince Edward Island • Nova Scotia • New Brunswick
Central Canada	<ul style="list-style-type: none"> • Quebec • Ontario
The Prairie Provinces	<ul style="list-style-type: none"> • Manitoba • Saskatchewan • Alberta
The West Coast	<ul style="list-style-type: none"> • British Columbia
The Northern Territories	<ul style="list-style-type: none"> • Nunavut • Northwest Territories • Yukon Territory

Each region enjoys its own distinct heritage, culture and resources:

Region	Resources	Heritage
Atlantic	Fishing, farming, forestry, mining, off-shore oil and gas extraction, hydro-electric, tourism, shipbuilding, shipping.	Celtic, Viking, Aboriginal, English and French
Central	Industry, manufacturing, farming, hydro-electric, forestry, mining, pulp and paper, film, finance, fruit and wine, dairy, beef.	Aboriginal, English and French
Prairie	Farming, mining, hydro-electric, grain, oilseed, oil and natural gas, beef.	English, French, Ukrainian, Aboriginal
West Coast	Forestry, mining, fishing, fruit and wine, tourism, shipping.	English, Asian, Aboriginal
Northern	Mining, oil and gas, hunting, fishing, trapping.	Aboriginal, English

THIS PAGE INTENTIONALLY LEFT BLANK

CANADA'S REGIONS: WORKSHEET

OBJECTIVE: The aim of this learning station is to familiarize cadets with the regions of Canada and symbols associated with each.

TIME: 30 min

TRAINING LEVEL: 3–4

PRE-ACTIVITY INSTRUCTIONS:

- This activity is self-directed by the cadets.
- Provide a quiet area large enough for all team members with a table and chairs.
- Gather the required resources:
 - Canada's Regions activity instruction sheet located at Appendix 1 (1 copy per team),
 - KWL Chart located at Appendix 2 (1 per cadet),
 - Canada's Regions overview located at Appendix 3 (1 per cadet), and
 - Canada's Regions worksheet located at Appendix 4 (1 per cadet).
- Post the Canada's Regions activity instruction sheet on the wall or tape it to the table.
- Place copies of Canada's Regions overview, worksheet and KWL chart on the table.

ACTIVITY INSTRUCTIONS:

Have the cadets read and follow the Canada's Regions activity instruction sheet.

THIS PAGE INTENTIONALLY LEFT BLANK

CANADA'S REGIONS

INSTRUCTIONS:

1. Consider what you already know about each of Canada's Regions. Complete the "K" and "W" columns of the KWL (Know, Want, Learned) chart.
2. Read the brief overview on Canada's Regions.
3. Answer each of the questions on the worksheet. Your answers don't have to be written out in full; they can be in point form. There are no "right" answers but your answers should be well thought out and supported.
4. Complete the "L" column of the KWL chart.
5. You have 30 minutes to complete this activity.

Things to consider:

- Which regions have you visited? How are they different from your own?
- What have you learned about your own region that you didn't know before?
- What have you learned about the other regions that you didn't know before?

THIS PAGE INTENTIONALLY LEFT BLANK

CANADA'S REGIONS KWL CHART

Complete the chart below based on:

1. What you **K**now about each of Canada's Regions,
2. What you **W**ant to know about each of Canada's Regions, and
3. What you have **L**earned about the topic (to be completed after reading the overview as part of the follow-up activity).

REGION	KNOW	WANT TO KNOW	LEARNED
Atlantic			
Central			
Prairie			

REGION	KNOW	WANT TO KNOW	LEARNED
West Coast			
Northern			

THIS PAGE INTENTIONALLY LEFT BLANK

CANADA'S REGIONS OVERVIEW

- Canada is the second largest country in the world.
- Three oceans line our coasts; the Pacific Ocean to the west, the Atlantic Ocean to the east and the Arctic Ocean to the north.
- The United States lies at the southern edge of Canada. The US – Canada boarder is the longest undefended boarder in the world.
- The National Capital is located in Ottawa and is the country's fourth largest metropolitan area.
- The population of Canada is approx 34 million people most of whom live in cities, but Canadians also live in small towns, villages and rural areas.
- Canada is divided into five distinct regions:

The Atlantic Provinces	<ul style="list-style-type: none">• Newfoundland and Labrador• Prince Edward Island• Nova Scotia• New Brunswick
Central Canada	<ul style="list-style-type: none">• Quebec• Ontario
The Prairie Provinces	<ul style="list-style-type: none">• Manitoba• Saskatchewan• Alberta
The West Coast	<ul style="list-style-type: none">• British Columbia
The Northern Territories	<ul style="list-style-type: none">• Nunavut• Northwest Territories• Yukon Territory



The Atlantic Provinces

Atlantic Canada's coasts and natural resources, including fishing, farming, forestry and mining, have made these provinces an important part of Canada's history and development. The Atlantic Ocean brings cool winters and cool humid summers.

- **Newfoundland and Labrador** is the most easterly point in North America and has its own time zone. In addition to its natural beauty, the province has a unique heritage linked to the sea. The oldest colony of the British Empire and a strategic prize in Canada's early history, the province has long been known for its fisheries, coastal fishing villages and distinct culture. Today off-shore oil and gas extraction contributes a substantial part of the economy. Labrador also has immense hydro-electric resources.
- **Prince Edward Island (P.E.I.)** is the smallest province, known for its beaches, red soil and agriculture, especially potatoes. P.E.I. is the birthplace of Confederation, connected to mainland Canada by one of the longest continuous multispan bridges in the world, the Confederation Bridge. Anne of Green Gables, set in P.E.I. by Lucy Maud Montgomery, is a much-loved story about the adventures of a little red-headed orphan girl.
- **Nova Scotia** is the most populous Atlantic Province, with a rich history as the gateway to Canada. Known for the world's highest tides in the Bay of Fundy, the province's identity is linked to shipbuilding, fisheries and shipping. As Canada's largest east coast port, deep-water and ice-free, the capital, Halifax, has played an important role in Atlantic trade and defence and is home to Canada's largest naval base. Nova Scotia has a long history of coal mining, forestry and agriculture. Today there is also off-shore oil and gas exploration. The province's Celtic and Gaelic traditions sustain a vibrant culture. Nova Scotia is home to over 700 annual festivals, including the spectacular military tattoo in Halifax.
- **New Brunswick** is situated in the Appalachian Range, the province was founded by the United Empire Loyalists and has the second largest river system on North America's Atlantic coastline, the St. John River system. Forestry, agriculture, fisheries, mining, food processing and tourism are the principal industries. Saint John is the largest city, port and manufacturing centre; Moncton is the principal Francophone

Acadian centre; and Fredericton, the historic capital. New Brunswick is the only officially bilingual province, and about one-third of the population lives and works in French. The province's pioneer Loyalist and French cultural heritage and history come alive in street festivals and traditional music.

Central Canada

More than half the people in Canada live in cities and towns near the Great Lakes and the St. Lawrence River in southern Quebec and Ontario, known as Central Canada and the industrial and manufacturing heartland. Southern Ontario and Quebec have cold winters and warm humid summers. Together, Ontario and Quebec produce more than three-quarters of all Canadian manufactured goods.

- **Quebec** has nearly eight million people, the vast majority along or near the St. Lawrence River. More than three-quarters speak French as their first language. The resources of the Canadian Shield have helped Quebec to develop important industries, including forestry, energy and mining. Quebec is Canada's main producer of pulp and paper. The province's huge supply of fresh water has made it Canada's largest producer of hydro-electricity. Quebecers are leaders in cutting-edge industries such as pharmaceuticals and aeronautics. Quebec films, music, literary works and food have international stature, especially in *La Francophonie*, an association of French-speaking nations. Montreal, Canada's second largest city and the second largest mainly French-speaking city in the world after Paris, is famous for its cultural diversity.
- **Ontario**, at more than 12 million, makes up more than one-third of Canadians. The large and culturally diverse population, natural resources and strategic location contribute to a vital economy. Toronto is the largest city in Canada and the country's main financial centre. Many people work in the service or manufacturing industries, which produce a large percentage of Canada's exports. The Niagara region is known for its vineyards, wines and fruit crops. Ontario farmers raise dairy and beef cattle, poultry, and vegetable and grain crops. Founded by United Empire Loyalists, Ontario also has the largest French-speaking population outside of Quebec, with a proud history of preserving their language and culture. There are five Great Lakes located between Ontario and the United States: Lake Ontario, Lake Erie, Lake Huron, Lake Michigan (in the U.S.A.) and Lake Superior, the largest freshwater lake in the world.

The Prairie Provinces

Manitoba, Saskatchewan and Alberta are the Prairie Provinces, rich in energy resources and some of the most fertile farmland in the world. The region is mostly dry, with cold winters and hot summers.

- **Manitoba's** economy is based on agriculture, mining and hydro-electric power generation. The province's most populous city is Winnipeg, whose Exchange District includes the most famous street intersection in Canada, Portage and Main. Winnipeg's French Quarter, St. Boniface, has Western Canada's largest Francophone community at 45,000. Manitoba is also an important centre of Ukrainian culture, with 14% reporting Ukrainian origins, and the largest Aboriginal population of any province, at over 15%.
- **Saskatchewan**, once known as the "breadbasket of the world" and the "wheat province," has 40% of the arable land in Canada and is the country's largest producer of grains and oilseeds. It also boasts the world's richest deposits of uranium and potash, used in fertilizer, and produces oil and natural gas. Regina, the capital, is home to the training academy of the Royal Canadian Mounted Police. Saskatoon, the largest city, is the headquarters of the mining industry and an important educational, research and technology centre.
- **Alberta** is the most populous Prairie province. The province, and the world-famous Lake Louise in the Rocky Mountains, were both named after Princess Louise Caroline Alberta, fourth daughter of Queen Victoria. Alberta has five national parks, including Banff National Park, established in 1885. The rugged Badlands house some of the world's richest deposits of prehistoric fossils and dinosaur finds. Alberta is the largest producer of oil and gas, and the oil sands in the north are being developed as a major energy source. Alberta is also renowned for agriculture, especially for the vast cattle ranches that make Canada one of the world's major beef producers.

- **The West Coast:** British Columbia is known for its majestic mountains and as Canada's Pacific gateway. The Port of Vancouver, Canada's largest and busiest, handles billions of dollars in goods traded around the world. Warm airstreams from the Pacific Ocean give the B.C. coast a temperate climate.
- British Columbia (B.C.), on the Pacific coast, is Canada's western most province, with a population of four million. The Port of Vancouver is our gateway to the Asia-Pacific. About one-half of all the goods produced in B.C. are forestry products, including lumber, newsprint, and pulp and paper products—the most valuable forestry industry in Canada. B.C. is also known for mining, fishing, and the fruit orchards and wine industry of the Okanagan Valley. B.C. has the most extensive park system in Canada, with approximately 600 provincial parks. The province's large Asian communities have made Chinese and Punjabi the most spoken languages in the cities after English. The capital, Victoria, is a tourist centre and headquarters of the navy's Pacific fleet.

The Northern Territories

The Northwest Territories, Nunavut and Yukon contain one-third of Canada's land mass but have a population of only 100,000. There are gold, lead, copper, diamond and zinc mines. Oil and gas deposits are being developed. The North is often referred to as the "Land of the Midnight Sun" because at the height of summer, daylight can last up to 24 hours. In winter, the sun disappears and darkness sets in for three months. The Northern territories have long cold winters and short cool summers. Much of the North is made up of tundra, the vast rocky Arctic plain. Because of the cold Arctic climate, there are no trees on the tundra and the soil is permanently frozen. Some continue to earn a living by hunting, fishing and trapping. Inuit art is sold throughout Canada and around the world.

- **Yukon** saw thousands of miners during the Gold Rush of the 1890s, as celebrated in the poetry of Robert W. Service. Mining remains a significant part of the economy. The White Pass and Yukon Railway opened from Skagway in neighboring Alaska to the territorial capital, Whitehorse in 1900 and provides a spectacular tourist excursion across precipitous passes and bridges. Yukon holds the record for the coldest temperature ever recorded in Canada (-63°C).
- **The Northwest Territories (N.W.T.)** were originally made up in 1870 from Rupert's Land and the North-Western Territory. The capital, Yellowknife (population 20,000), is called the "diamond capital of North America." More than half the population is Aboriginal (Dene, Inuit and Métis). The Mackenzie River, at 4,200 kilometers, is the second-longest river system in North America after the Mississippi and drains an area of 1.8 million square kilometers.
- **Nunavut**, meaning "our land" in Inuktitut, was established in 1999 from the eastern part of the Northwest Territories, including all of the former District of Keewatin. The capital is Iqaluit, formerly Frobisher Bay, named after the English explorer Martin Frobisher, who penetrated the uncharted Arctic for Queen Elizabeth I in 1576. The 19-member Legislative Assembly chooses a premier and ministers by consensus. The population is about 85% Inuit, and Inuktitut is an official language and the first language in schools.

CANADA'S REGIONS *WORKSHEET*

1. What three things that stood out / made the most impression on you after reading the overview on Canada's Regions?
2. What, if anything, new have you learned about your own Region?
3. What have you learned about the other regions that you didn't already know?

4. How would you describe Canada to a person interested in moving to our country?

5. The different regions of Canada make it an exciting and interesting place to live. What is your favourite thing about Canada?



**COMMON TRAINING
ALL TRAINING LEVELS
INSTRUCTIONAL GUIDE
CITIZENSHIP**



SECTION 9

EO CX01.01 – PARTICIPATE IN CITIZENSHIP ACTIVITIES

Total Time:

Six sessions (18 periods)

THERE IS NO INSTRUCTIONAL GUIDE PROVIDED FOR THIS EO. REFER TO THE LESSON SPECIFICATION LOCATED IN A-CR-CCP-701/PG-001, ROYAL CANADIAN ARMY CADETS GREEN STAR QUALIFICATION STANDARD AND PLAN.

THIS PAGE INTENTIONALLY LEFT BLANK

CHAPTER 2
PO X02 – PERFORM COMMUNITY SERVICE



**COMMON TRAINING
ALL TRAINING LEVELS
INSTRUCTIONAL GUIDE
COMMUNITY SERVICE**



SECTION 1

EO MX02.01 – PERFORM COMMUNITY SERVICE

Total Time:

3 sessions (9 periods) = 270 min

PREPARATION

PRE-LESSON INSTRUCTIONS

This IG supports EO MX02.01 (Perform Community Service) located in A-CR-CCP-701/PG-001, *Royal Canadian Army Cadets Green Star Qualification Standard and Plan*, Chapter 4.

Read and prepare to conduct The Five Stages of Service Learning located at Annex A.

See Examples of Community Service located at Attachment F to get an idea of what community service using the five stages of service learning might look like.

PRE-LESSON ASSIGNMENT

Nil.

APPROACH

A practical activity was chosen for this lesson as it allows the cadets to interact with their peers while providing a service to the community.

INTRODUCTION

REVIEW

Nil.

OBJECTIVES

By the end of this lesson the cadet shall have performed community service that:

- has value, purpose, and meaning;
- uses previously learned and newly acquired skills and knowledge;
- offers unique learning experiences;
- has real consequences; and
- offers a safe environment to learn, to make mistakes, and to succeed.

IMPORTANCE

It is important for cadets to perform community service as it contributes directly to supporting part of the aim of the Cadet Program—to develop attributes of good citizenship. Through participating in all five stages of service learning, cadets recognize how participation and the ability to respond to authentic needs improves the quality of life in the community, which leads to a lifelong ethic of service and civic participation.

ACTIVITY



Refer to The Five Stages of Service Learning located at Annex A for more details on each stage.



Youth voice and youth choice are essential for cadet buy-in and ownership over the service learning process. To the greatest extent possible, the community service should be cadet-led.

1. Have the cadets complete Stage 1 of Service Learning (Inventory and Investigation) by:
 - (a) developing a list or spreadsheet of cadet interests, skills, and talents through an activity such as:
 - (1) having cadets complete a personal inventory worksheet, such as the one located at Annex B;
 - (2) conducting a survey with the cadets; or
 - (3) interviewing cadets;
 - (b) selecting a need in the community by:
 - (1) identifying an existing program or activity that is addressing a community need;
 - (2) identifying a need in the community that has been observed; or
 - (3) receiving a request from the community for assistance in meeting a need; and
 - (c) investigating the underlying problem and validating the need by having the cadets:
 - (1) examine media, such as books, magazines, or newspapers;
 - (2) conduct interviews with people who have expertise in the subject matter;
 - (3) review past experiences;
 - (4) observe relevant situations (eg, investigating homelessness by visiting a local shelter); or
 - (5) conduct a survey with people who may have knowledge about the subject matter.

2. Have the cadets complete Stage 2 of Service Learning (Preparation and Planning) by developing a plan that uses the identified skills and knowledge to address, as much as possible, the underlying problem behind the community need. The Community Service Proposal at Annex C may be used to help develop the plan. The plan should:
 - (a) describe the involvement of community partners;
 - (b) define the goal of the community service;

- (c) describe anticipated results;
 - (d) identify how to measure the effects;
 - (e) identify how progress will be monitored;
 - (f) define roles and responsibilities of all involved;
 - (g) include a timeline for all tasks; and
 - (h) identify required resources.
3. Have the cadets complete Stage 3 of Service Learning (Action) by completing the community service while monitoring progress using the indicators identified in Stage 2: Preparation and Planning and adapting the plan as necessary.
4. Have the cadets complete Stage 4 of Service Learning (Reflection) by completing an activity that places the community service within the context of themselves personally, the community directly served, and greater communities (eg, national or global), such as:
- (a) the four square reflection tool located at Annex D,
 - (b) a journal, blog, or video blog,
 - (c) an analysis of a “day in the life” of those benefiting from the service. How has it changed? How might they feel differently?
 - (d) a piece of art that represents the community service activity, or
 - (e) another activity that provides a structured avenue for reflecting on the community service.
5. Have the cadets complete Stage 5 of Service Learning (Demonstration) by completing an activity that showcases what they have done and the effect it has had on themselves (such as new skills, knowledge, or understandings) and the community, such as:
- (a) a video or photo essay,
 - (b) a letter to the editor,
 - (c) an article for local or corps / squadron media,
 - (d) a presentation or performance, or
 - (e) a public display of art.



A checklist is located at Annex E to guide cadets through the stages of Service Learning.

END OF LESSON CONFIRMATION

The cadets' participation in community service will serve as the confirmation of this lesson.

CONCLUSION

HOMEWORK / READING / PRACTICE

Nil.

METHOD OF EVALUATION

Nil.

CLOSING STATEMENT

Community service not only has a positive impact on others in your community—it has a positive impact on you by developing critical thinking and problem-solving skills; growing your understanding of diverse cultures and communities; providing an opportunity to learn more about social issues and their root causes; and developing your communication, collaboration, and leadership skills. Seek out opportunities to be a good citizen by positively contributing to your community.

INSTRUCTOR NOTES / REMARKS

Youth voice is key to developing cadets as leaders. Cadets need ample opportunities to express their ideas and opinions, and to make constructive choices and see the results. Community service enables cadets to take initiative, make decisions, interact with community representatives, learn about the role of government in social issues, develop critical-thinking skills, put their ideas into action, and assess and evaluate what happened.

More than one community service activity may be chosen to complete the required training time.

If additional time is required to complete all five stages of service learning, periods from C102.01 (Perform Community Service) may be used.

The community service activity shall not have any partisan political association or support any single religious denomination or belief system.

The community service activity shall not directly benefit the corps / squadron or the sponsor.

REFERENCES

Kaye, Cathryn B. *The Complete Guide to Service Learning: Proven, Practical Ways to Engage Students in Civic Responsibility, Academic Curriculum, & Social Action*. Minneapolis, MN: Free Spirit Publishing Inc, 2010.

THE FIVE STAGES OF SERVICE LEARNING

STAGE 1: INVENTORY AND INVESTIGATION

Objective

The aim of the first stage of service learning is to select a genuine opportunity for meaningful community service by identifying a verified need in the community that appeals to the cadets' interests and which their skills and knowledge will allow them to fill.

Process

First, a personal inventory is created, identifying the skills, knowledge, and strengths of the cadets. This simple list will serve as a tool to identify the optimal manner in which the cadets can address a community need.

Second, a need in the community is identified. This may be done by:

- identifying an existing program or activity that is addressing a community need;
- observing a need in the community; and / or
- receiving a request from the community for assistance in meeting a need.

The cadets then investigate the problem and validate the need. The observable need or issue may be the manifestation or symptom of a larger problem. Where possible, the underlying problem should be the target of the community service rather than the visible need. For example, to address the need posed by litter in a park, the cadets could arrange for the installation of additional garbage cans rather than organizing patrols. This would address the underlying problem, a lack of places to put garbage, rather than the observable issue (the presence of trash).



Even if a need is identified through a request from a community member or organization, an investigation is still conducted to document, authenticate, and understand the underlying problem behind the need.

Research methods that may be used to investigate underlying problems and validate needs include:

- examining the media, such as books, magazines, and newspapers;
- conducting interviews with people who have expertise in the subject matter;
- reviewing past experiences;
- observing relevant situations (eg, investigating homelessness by visiting a local shelter); and
- conducting a survey with people who may have knowledge about the subject matter.

When the investigation is completed, the cadets will understand the extent of the need and have developed a baseline from which they may monitor progress.

STAGE 2: PREPARATION AND PLANNING

Objective

The aim of the second stage of the service learning process is to prepare the cadets to complete the service by developing a plan.

Process

With guidance and support from their supervisor, cadets:

- draw upon previously acquired skills and knowledge;
- acquire new information through varied, engaging means and methods;
- collaborate with community partners;
- develop a plan;
- become ready to provide meaningful community service;
- articulate roles and responsibilities of all involved; and
- define realistic parameters for implementation.



Communicating with stakeholders (those who will be affected by the community service activity) and building partnerships with other community organizations (governments, businesses, community groups, etc.) are key to the success of the community service activity. For example, if cadets are interested in beautifying a local park, they will need to make contacts with the municipality and park users.

STAGE 3: ACTION

Objective

In this stage, the community service is conducted.

Process

While conducting the community service, it is important that the cadets monitor progress towards the objectives, conduct more research as needed, and alter the plan as required.

STAGE 4: REFLECTION



Stage 4: Reflection may occur both during and after implementation of the community service activity. Reflection during the activity may reveal better ways to complete the community service or a new focus.

Objective

The aim of the fourth stage is to place the service learning experience in the context of the cadets, the community, and the global community.

Process

Through reflection activities such as discussion, journaling, and worksheets, cadets:

- describe what happened;
- examine the difference made;
- discuss thoughts and feelings;
- consider project improvements;
- generate ideas and identify questions; and
- receive feedback.

Reflection is integral to service learning. During the reflection stage, cadets link learning and experience with personal growth and awareness. When cadets reflect on their experiences during community service activities, they consider how the knowledge, experience and skills gained relate to their own lives and communities and begin to understand the purpose of their engagement.

Since people naturally reflect in different ways, more cadets will be engaged by allowing a variety of reflection methods. Examples of reflection activities include art, music, role play, journals, sculpture, drama, worksheets, photographs, and discussion.



Reflection through group discussion can have its drawbacks as cadets can be influenced by the comments of others, causing the conversation to go in circles. Have cadets write down responses to reflection questions in brief notes before the group discussion so they can refer to their written thoughts in conversation. This simple act preserves the integrity of each cadet's experience before it can be influenced by others' impressions and assures that everyone has something to contribute.

Regardless of the reflection activity chosen, some questions that can be posed to the cadets to assist them with reflection include:

- What did the experience remind you of?
- What did you learn that you didn't know before?
- How did you feel being at the service site? How did your feelings change from when you first arrived to when you left?
- How did you make a difference today?
- Five years from now, what do you think you will remember about this experience?
- What can we all do to make our time and efforts have a bigger impact?

STAGE 5: DEMONSTRATION

Objective

The aim of the final stage of the service learning model is to showcase what the cadets have done and the effect it has had on them and the community.

Process

Demonstration is the stage of the Community Service Model where cadets showcase what they have done and the effect it has had on them and the community.

Presenting what they have learned allows cadets to teach others while also identifying and acknowledging to themselves what they have learned and how they learned it. When cadets tell others about what they have done and the impact of their actions, it re-enforces the intrinsic value of community service.



Demonstrations need to be cadet-led with supervisor guidance and support to be effective. If cadets do not feel they are in control of the product they are creating, they will not apply their full efforts to complete it.

THIS PAGE INTENTIONALLY LEFT BLANK

PERSONAL INVENTORY

Interests are what you like to think about and what you would like to know more about—for example, outer space, popular music, or a historical event like a world war. Are you interested in animals, movies, mysteries, or visiting faraway places? Do you collect anything?

I like to learn and think about . . .

Skills have to do with things you like to do or that you do easily or well. Do you have an activity you especially like? Do you sing, play the saxophone, or study ballet? Do you know more than one language? Can you cook? Do you have a garden? Do you prefer to paint pictures or play soccer? Do you have any special computer abilities?

I can . . .

Knowledge sets are what you know and understand well. Do you have a favourite subject in school? What do you like to read about in your spare time?

I know about . . .

THIS PAGE INTENTIONALLY LEFT BLANK

COMMUNITY SERVICE PROPOSAL

By: _____

Supervisor: _____ Corps / Squadron: _____

Corps / Sqn Address: _____

Phone: _____ Fax: _____ Email: _____

Project name: _____

Need—Why this plan is needed:

Purpose—How this plan will help:

Participation—Who will help and what they will do:

- Cadets:
- Staff:
- Organizations or groups:

Outcomes—What we expect to happen as a result of our work:

How we will check outcomes—What evidence we will collect and how we will use it:

Resources—What we need to get the job done, such as supplies (itemize on back):

THIS PAGE INTENTIONALLY LEFT BLANK

FOUR SQUARE REFLECTION TOOL

<p>What happened?</p>	<p>How do I feel?</p>
<p>Ideas?</p>	<p>Questions?</p>

THIS PAGE INTENTIONALLY LEFT BLANK

COMMUNITY SERVICE CHECKLIST

Inventory and Investigation	Identify skills and interests	
	Identify a community need to address	
	Investigate the underlying problem	
	Identify potential community partners	
Preparation and Planning	Collaborate with community partners	
	Define the goal of the community service	
	Describe anticipated results	
	Identify how to measure the effects of the community service	
	Identify how progress will be monitored	
	Define roles and responsibilities of all involved	
	Create a timeline for all tasks	
	Identify required resources	
	Create a budget if required	
Action	Monitor progress	
Reflection	Describe what happened	
	Examine the difference made	
	Discuss thoughts and feelings	
	Consider activity improvements	
	Generate ideas and identify questions	
	Receive feedback	
Demonstration	Identify an audience	
	Identify a time and place to do the demonstration	
	Create a demonstration	
	Execute the demonstration	

THIS PAGE INTENTIONALLY LEFT BLANK

EXAMPLES OF COMMUNITY SERVICE

Community Garden. Through a survey of local residents, cadets identify the need for a community garden. The personal inventory reveals a couple of cadets with gardening experience and several more cadets who know people with gardening experience. They contact the municipality to get the required permissions to use an empty lot. Cadets do research into community gardens and form partnerships with those community members interested in having plots in the garden. Cadets plan and build the infrastructure for the community garden, including the creation of plots. They demonstrate their project by giving a joint presentation with their community partners at a municipal council meeting.

Disabled Program. Through the personal inventory one cadet reveals the volunteer work they do for a local disabled program and indicates a need for more volunteers. They talk about some of the things volunteers do for the program, such as organizing activities and entertainment. The cadets express interest in helping out and arrange a visit to become familiar with the program and to meet the participants, staff, and other volunteers. After their visit the cadets brainstorm some activities they can do with the program participants. After planning and executing an evening of fun activities, the cadets reflect on the impact made. Although they are proud of the impact they made for that evening, one cadet points out that the disabled program will still have a shortage of regular volunteers into the future. Cadets then decide to take their community service project one step further by creating an advertising campaign to attract more volunteers to the program.

Food Drive. Cadets decide to get involved with the local food drive. They contact the Food Bank, do a tour of the facility, learn about the food needs of the local community, and spend two hours organizing and sorting non-perishable food items. Cadets help the Food Bank promote the upcoming food drive by creating posters and speaking with local media. Cadets create a sign-up list for parent volunteers to drive, divide themselves into teams of three, and assign each team a geographic area to cover during the food drive. The cadets demonstrate their project by creating an article that they distribute to the local newspaper.

Remembrance Day and Poppy Campaign. Cadets are approached by the Royal Canadian Legion to participate in the annual Poppy Campaign and Remembrance Day ceremony. Cadets research the Royal Canadian Legion and learn about some of the initiatives it leads using the moneys raised during the Poppy Campaign, such as the creation and care of memorials. Cadets also learn the history of the poppy and how it came to be a symbol of remembrance, and invite a veteran to speak about what remembrance means to them. Cadets identify several other ways they can thank and support veterans. They create a demonstration for their Annual Ceremonial Review to make others aware of how they can get involved.

Emergency Health Services. A cadet living in a rural area loses his father to a heart attack. A factor in his father's death was the time it takes for medical assistance to reach his community. Cadets decide to address this problem. After brainstorming, researching, and communicating with local government and medical services, cadets come up with two ways to improve medical assistance in the community. First, they all agree to take first aid training and arrange for a first aid provider to come to the community to deliver that training. Second, they use GPS to create detailed maps of the local community for use by the ambulance services, leading to reduced response times. Some cadets reveal during the reflection activity that they see a potential future career in health services. The cadets demonstrate their accomplishments by doing a first aid display at a CO's Parade.

Recycling Program. Cadets identify the need for a recycling program in their community. Through their research they discover that a recycling program has not been set up in the community because the nearest recycling plant is so far as to make transportation costs prohibitive. The personal inventory indicates several of the cadets have ties to local businesses. Cadets have some discussions with local business owners and realize that the truck that regularly re-stocks the grocery store is empty when it leaves the community. Cadets contact the trucking company and arrange to have the recyclables shipped out regularly. After successfully solving this piece of the puzzle, the cadets enthusiastically go about planning, promoting, and implementing the community's recycling program. To demonstrate the project they give a presentation at a municipal council meeting.

Election. Through their personal inventory, cadets discover a common interest in the upcoming election so they decide to get in touch with election organizers to find out how they can help. The cadets investigate the electoral process and volunteer to register voters and work the polls on election day. During reflection, the cadets discuss what it means to them to be citizens of a democratic country. This leads to discussions about refugees fleeing from countries where they are in danger and oppressed. They decide their next community service activity will be to learn about the stories of local refugees and to host a Citizenship Ceremony.

Animal Humane Society. Upon reviewing their personal inventory, cadets recognize many of them share an interest in the welfare of animals, so they plan a trip to the local animal humane society. After discussing the need to care for pets responsibly, cadets create a brochure called "Taking Care of Your Pet". The brochure is distributed by the humane society and, after making contacts with administration at several local schools, by the cadets who attend these schools. During the reflection activity, some cadets decide to volunteer to walk the dogs as part of their personal community service. The cadets demonstrate their project by creating a display consisting of photos of each cadet either with their pet or with an animal at the humane society. The display is posted at the humane society.



**COMMON TRAINING
ALL TRAINING LEVELS
INSTRUCTIONAL GUIDE
COMMUNITY SERVICE**



SECTION 2

EO CX02.01 – PERFORM COMMUNITY SERVICE

Total Time:

6 sessions (18 periods) = 540 min

THERE IS NO INSTRUCTIONAL GUIDE PROVIDED FOR THIS EO. REFER TO THE INSTRUCTIONAL GUIDE FOR EO MX02.01 (PERFORM COMMUNITY SERVICE).

THIS PAGE INTENTIONALLY LEFT BLANK

CHAPTER 3

PO 103 – PARTICIPATE AS A MEMBER OF A TEAM



**COMMON TRAINING
GREEN STAR
INSTRUCTIONAL GUIDE**



SECTION 1

EO M103.01 – IDENTIFY THE RESPONSIBILITIES OF A FOLLOWER IN A TEAM

Total Time:

30 min

PREPARATION

PRE-LESSON INSTRUCTIONS

Resources needed for the delivery of this lesson are listed in the lesson specification located in A-CR-CCP-701/PG-001, *Green Star Qualification Standard and Plan*, Chapter 4. Specific uses for said resources are identified throughout the instructional guide within the TP for which they are required.

Review the lesson content and become familiar with the material prior to delivering the lesson.

Cut up Scrambled Words Handout located at Attachment A into strips.

PRE-LESSON ASSIGNMENT

Nil.

APPROACH

An interactive lecture was chosen for this lesson to orient the cadets to identify responsibilities of a follower in a team and generate interest.

INTRODUCTION

REVIEW

Nil.

OBJECTIVES

The cadet shall have explained the responsibilities of a follower in a team environment.

IMPORTANCE

Cadets need to learn how to be effective members of a team. Understanding the responsibilities of a follower in a team setting makes cadets more aware of what is expected of them. This knowledge enables them to contribute to the overall success of the team.

Teaching Point 1**Explain the following four responsibilities of a follower.**

Time: 10 min

Method: Interactive Lecture

RESPECT THE LEADER AND OTHER TEAM MEMBERS

The ability to work with other people in a team is a useful skill. A sincere respect for other people is a great asset. In order to be an effective team member one must respect what the leader is asking the team to do. It is also important to respect the opinion and views of the other members of the team.

COOPERATE WITH OTHERS

In order for the team to effectively and efficiently achieve an objective the members must co-operate. Through co-operation a great deal more can be achieved than by working alone.

ADMIT MISTAKES AND LEARN FROM EXPERIENCE

In a team setting one must be able to admit when they are wrong and learn from the mistake. This makes the team stronger and creates a better outcome.

ACCEPT CONSTRUCTIVE CRITICISM

Constructive criticism is observations or thoughts about ways to improve the manner in which a task was completed. Leaders will often provide constructive criticism to members of the team. This criticism is given to assist individuals develop as team member and eventually become leaders. Members must learn to take this criticism and use it in a beneficial way.

CONFIRMATION OF TEACHING POINT 1

QUESTIONS:

- Q1. What is constructive criticism?
- Q2. What does it mean to admit mistakes and learn from experience?
- Q3. Why is it important to respect the leader and other team members?

ANTICIPATED ANSWERS:

- A1. Constructive criticism is observations or thoughts about ways to improve the manner in which a task was completed.
- A2. In a team setting one must be able to admit when they are wrong and learn from the mistake. This makes the team stronger and creates a better outcome.
- A3. The ability to work with other people in a team is a useful skill. A sincere liking and respect for other people is a great asset. In order to be an effective team member one must respect what the leader is asking the team to do. It is also important to respect the opinion and views of the other members of the team.

Teaching Point 2**Explain the following five responsibilities of a follower in a team.**

Time: 15 min

Method: Interactive Lecture

ASSUME RESPONSIBILITY

Team members should be prepared to assume responsibility when needed. The team leader delegates duties to team members and relies on these members to be prepared and willing to take on the responsibility.

BE HONEST

Team members must be honest with others in the team. Most people believe and want to work with someone they trust. Honesty is an important characteristic of a good follower. In order to complete objectives, team members must trust each other and be honest.

ACCEPT OTHER TEAM MEMBERS FOR WHO THEY ARE

It is important to be sensitive to other people's wants and needs and to changes in these wants and needs. Acceptance and understanding of individual differences allows the group to communicate and cooperate.

KNOW THE JOB AND BE PREPARED

A good follower needs to be knowledgeable about the group's goals. An effective follower should be organized and prepared.

COMMUNICATE CLEARLY WITH OTHERS

A follower must be able to understand and communicate with the leader and other team members. Communication works in two directions, listening and speaking. The ability to listen to others is essential in receiving correct information and implementing the strategy outlined for the team.

CONFIRMATION OF TEACHING POINT 2

QUESTIONS:

- Q1. Why is it important to be honest in a team?
- Q2. What does it mean to communicate clearly with others?
- Q3. Why must a team member assume responsibility?

ANTICIPATED ANSWERS:

- A1. Team members must be honest with others in the team. Most people believe and want to work with someone they trust. Honesty is an important characteristic of a good follower. In order to complete objectives, team members must trust each other and be honest.
- A2. A follower must be able to understand and communicate with the leader and other team members. Communication works in two directions, listening and speaking. The ability to listen to others is essential in receiving correct information and implementing the strategy outlined for the team.
- A3. Team members should be prepared to assume responsibility when needed. The team leader delegates duties to team members and will rely on these members to be prepared and willing to take on the responsibility.

END OF LESSON CONFIRMATION

ACTIVITY

Time: 5 min

OBJECTIVE

The objective of this activity is for the cadets to unscramble the responsibilities of a follower in a team and explain what each means.

RESOURCES

- Scrambled responsibilities found in Attachment A.
- Container to pick scrambled responsibilities from.

ACTIVITY LAYOUT

Nil.

ACTIVITY INSTRUCTIONS

1. Divide the class into nine groups. If the class is too small, fewer groups can be formed.
2. Have one member from each group pick a slip from the container.
3. Each group will unscramble the words to reveal one of the responsibilities of a follower.
4. The group is to discuss what the responsibility means.
5. Each group is to present their answer to the class.

SAFETY

Nil.

CONCLUSION

HOMEWORK / READING / PRACTICE

Nil.

METHOD OF EVALUATION

Nil.

CLOSING STATEMENT

Understanding the responsibilities of a follower in a team is essential for team members. Knowing what is expected of them will help create a successful outcome.

INSTRUCTOR NOTES / REMARKS

Nil.

REFERENCES

C3-038 Campbell, R. (2006). *Leadership: Getting it done*. Retrieved 16 Mar 06, from <http://www.ssu.missouri.edu/faculty/rcampbell/leadership/chapter5.htm>.

THIS PAGE INTENTIONALLY LEFT BLANK

SCRAMBLED WORDS

CERPTES HET DERLEA NDA EHORT AETM BESMERM

RPCOEAEOT TWHI TSERSON

IAMTD STSAKIEM DNA RLENA MFOR XRPEIECNEE

PCETCA SRUCONTTIVEC IISCTMRC

SUSAME YEBPISONSILRIT

EB TENHOS

EACTCP HTROE AEMT ESMBRME OFR HWO YEHT RAE

NOWK ETH BOJ NAD EB PPRDREAE

MAOCMUENCIT LYEACRL TIHW EHORST



COMMON TRAINING
GREEN STAR
INSTRUCTIONAL GUIDE



SECTION 2

EO M103.02 – MAP A PERSONAL GOAL FOR THE TRAINING YEAR

Total Time:

30 min

PREPARATION

PRE-LESSON INSTRUCTIONS

Resources needed for the delivery of this lesson are listed in the lesson specification located in A-CR-CCP-701/PG-001, *Green Star Qualification Standard and Plan*, Chapter 4. Specific uses for said resources are identified throughout the instructional guide within the TP for which they are required.

Review the lesson content and become familiar with the material prior to delivering the lesson.

Photocopy the SMART Goal handout located at Attachment A for each cadet.

PRE-LESSON ASSIGNMENT

Nil.

APPROACH

An interactive lecture was chosen for TP1 as it is an effective way to generate interest and motivate the cadets to set personal goals for themselves.

An in-class activity was chosen for TP2 as it is an interactive way to provoke thought and stimulate interest among cadets.

INTRODUCTION

REVIEW

Nil.

OBJECTIVES

By the end of the lesson, the cadets will have mapped a personal goal for the training year.

IMPORTANCE

It is important for cadets to set goals that will encourage personal development and motivate them to complete tasks.

Teaching Point 1**Explain the concept of goal setting.**

Time: 10 min

Method: Interactive Lecture

DEFINITION OF A GOAL

A goal is an aim an individual or group works toward; an object of ambition / effort.

DIFFERENCE BETWEEN SHORT-TERM AND LONG-TERM GOALS

Short-term goals are those that can be met in a short period of time and are often set to achieve long-term goals. For example, if an individual strives to run five kilometers by the end of the year, their short-term goal could be to run two kilometers within two months. By setting achievable short-term goals, individuals can measure their progress in the pursuit of their long-term goals.

HOW TO DEVELOP GOALS

Goals should be set with a specific purpose in mind. They should be measurable and achievable, allowing individuals to track progress. A goal should be something an individual can be motivated toward achieving.

SMART GOAL SETTING

Distribute the SMART Goal handout located at Attachment A. Discuss with the cadets what each letter in “SMART” represents and give an example of a SMART goal.

Cadets should set a specific goal to work toward. The acronym SMART is a tool the cadets may find useful.

S stands for specific: the aim of the goal must be precisely defined.

M stands for measurable: identify a standard against which to assess achievement.

A stands for attainable: ensure needed resources are accessible for accomplishing the goal.

R stands for realistic: ensure the goal is worthwhile for the cadet.

T stands for timely: the completion date of the goal.

Ask the following questions to the cadets to help elicit SMART goals:

Specific. What specific activity, or activities, can you do to help you reach your goal? Your goal should be concise and focused on one specific outcome (your goal cannot be too vague).

Measurable. How often will I work toward my goal? How long will I work at activities that help me to meet my goal? How can I track my progress in meeting my goal? Measuring your progress will help you to track your success and maintain motivation.

Attainable. How can I reach my goal? Are there people who can help me reach my goal? Do I have any attitudes that I need to change in order to meet my goal? Identifying the resources and supports that are available to help meet a goal is important to keep you on track.

Realistic. Can I really reach my goal? Is my goal too big? Would a smaller goal be more realistic and help me ensure success? Running a marathon is a big goal and one that will not likely be achieved by many; however, joining a running club or running smaller distances may be realistic attainable goals.

Timely. When will I start to work on my goal? When do I want to have my goal completed? Goals are more effective if they have time associated with them.



SMART Goal Example

- SMART GOAL:** By the Commanding Officer's (CO's) parade in December, I will have all of my badges sewn onto my uniform in the correct positions.
- Specific:** I will have all my badges sewn onto my uniform in the correct positions. I will not have any loose threads.
- Measurable:** I will get a copy of the dress instructions that show where badges will be sewn onto the uniform. I will ask my mom to help me sew the badges onto my uniform. I will work on my sewing every Thursday night until all the badges are sewn correctly. I will meet my Sergeant the week before the December CO's parade to make sure my badges are sewn onto my uniform in the correct positions. I will spend the Monday night before CO's parade correcting any errors my Sergeant finds with the badges on my uniform.
- Attainable:** I will check with my fellow Green Star cadets to ensure my uniform is correct. I will also seek advice from my Sergeant.
- Timely:** I will start at this week's parade night by asking for a copy of the dress instructions. I will work at completing my goal each Thursday night until CO's parade.

CONFIRMATION OF TEACHING POINT 1

QUESTIONS

- Q1. What is a goal?
- Q2. What is the difference between short-term and long-term goals?
- Q3. What is SMART?

ANTICIPATED ANSWERS

- A1. A goal is an aim an individual or group works toward; an object of ambition / effort.
- A2. Short-term goals are those that can be met in a short period of time and are often set to achieve long-term goals.
- A3. Specific, measurable, attainable, realistic, and timely.

Teaching Point 2**Conduct a goal mapping activity.**

Time: 15 min

Method: In-Class Activity

ACTIVITY

OBJECTIVE

The objective of this activity is to have the cadets map a personal goal for the training year.

RESOURCES

- SMART Goal handout located at Attachment A, and
- Pen / Pencil.

ACTIVITY LAYOUT

Nil.

ACTIVITY INSTRUCTIONS

1. Have the cadets brainstorm and record on flipchart paper a list of achievable training year goals.
2. Have each cadet pick a goal from the list.
3. Have the cadets complete the SMART Goal handout based on their identified goal.
4. Check that each cadet has completed the form.
5. Cadets will keep their completed form.

CONFIRMATION OF TEACHING POINT 2

The cadets' participation in the activity will serve as the confirmation of this TP.

END OF LESSON CONFIRMATION

The cadets' participation in the activity will serve as the confirmation of the lesson.

CONCLUSION

HOMEWORK / READING / PRACTICE

Nil.

METHOD OF EVALUATION

Nil.

CLOSING STATEMENT

You will have many opportunities to set goals in the cadet program. When you set goals remember to be SMART!

INSTRUCTOR NOTES / REMARKS

Nil.

REFERENCES

- C0-021 ISBN 1-58062-513-4 Adams, B. (2001). *The Everything Leadership Book*. Avon, MA: Adams Media.
- C0-022 ISBN 0-02864-207-4 Cole, K. (2002). *The Complete Idiot's Guide to Clear Communication*. Indianapolis, IN: Alpha Books.
- C0-431 Health Canada. (2011). *Eat Well and Be Active Education Toolkit*. Retrieved September 29, 2011, from <http://hc-sc.gc.ca/fn-an/food-guide-aliment/educ-comm/toolkit-trousse/plan-3a-eng.php>

THIS PAGE INTENTIONALLY LEFT BLANK

SMART GOAL

	Definition	My Smart Goal
Specific	<p>What do I want to do?</p> <p>What specific activity, or activities, can you do to help you reach your goal? Your goal should be concise and focused on one specific outcome (your goal cannot be too vague).</p>	
Measurable	<p>How much and how often will I do it?</p> <p>How often will I work toward my goal? How long will I work at activities that help me to meet my goal? How can I track my progress in meeting my goal? Measuring your progress will help you to track your success and maintain motivation.</p>	
Attainable	<p>How will I do it?</p> <p>How can I reach my goal? Are there people who can help me reach my goal? Do I have any attitudes that I need to change in order to meet my goal? Identifying the resources and supports that are available to help meet a goal is important to keep you on track.</p>	
Realistic	<p>Can I do it?</p> <p>Can I really reach my goal? Is my goal too big? Would a smaller goal be more realistic and help me ensure success? Large goals can be broken down into smaller goals that are more easily obtained and tracked.</p>	
Timely	<p>When will I do it?</p> <p>When will I start to work on my goal? When do I want to have my goal completed? Goals are more effective if they have time associated with them.</p>	

THIS PAGE INTENTIONALLY LEFT BLANK



**COMMON TRAINING
GREEN STAR
INSTRUCTIONAL GUIDE**



SECTION 3

EO M103.03 – PARTICIPATE IN TEAMBUILDING ACTIVITIES

Total Time:

60 min

PREPARATION

PRE-LESSON INSTRUCTIONS

Resources needed for the delivery of this lesson are listed in the lesson specification located in A-CR-CCP-701/PG-001, *Green Star Qualification Standard and Plan*, Chapter 4. Specific uses for said resources are identified throughout the instructional guide within the TP for which they are required.

Review the lesson content and become familiar with the material prior to delivering the lesson.

Ensure that an OHP has been set-up.

Bring paper and pens for group work.

PRE-LESSON ASSIGNMENT

Nil.

APPROACH

An in-class activity was chosen for TPs 1–3 as it is an interactive way to present team building activities and the learning objective.

A group discussion was chosen for TP4 as it allows the cadet to interact with their peers and share their knowledge, opinions and feelings about the advantages and characteristics of a successful team.

INTRODUCTION

REVIEW

Nil.

OBJECTIVES

The cadet shall participate in teambuilding activities and discuss the characteristics and advantages of a successful team.

IMPORTANCE

Having the skills to work as an effective team member is essential to the success of the team. Once introduced to these skills, they will continue to develop whenever the individual is placed in a team setting or situation that require people to work together.

Teaching Point 1**Conduct the teambuilding activity “the Human Knot.”**

Time: 10 min

Method: In-Class Activity

BACKGROUND KNOWLEDGE**CHARACTERISTICS OF A SUCCESSFUL TEAM**

- Communication – Clear communication is essential to an effective team. Team members must feel comfortable sharing ideas and concerns with each other and the leader.
- Mutual cooperation and support – It is hard to be innovative when you are not sure how others will react to your ideas. Team members must be aware that even if people disagree the objection is to the idea, not to the person presenting it. Members of a team must have the right to a certain level of trust that precludes backstabbing, gossip and negative behaviours aimed solely at making someone look bad.
- Share a common goal – When a team understands the purpose for a task they have a heightened motivation to work together towards the completion of it.
- High esprit de corps – When each member of the team has a sense of pride and belonging to the team, it is more likely they will want to be part of the team. This sense of belonging will enable the group to become more cohesive and willing to work together to accomplish the task.

ADVANTAGES OF EFFECTIVE TEAMWORK

- Includes everyone and ensures a better outcome – In a team setting people feel that their contributions are valuable. A strong group performance is generated from strong individual efforts. When many individuals are working together to accomplish a task different ideas and opinions mesh together to provide a sound outcome.
- Tasks are easier when more people are involved – When the responsibility and workload are shared among the team members and the team works together to ensure everyone stays on track, the team will offer support to those who need it.
- Increases and develops communication – Teamwork is an opportunity for people to interact in new ways by forming relationships and communicating with new people. Communication is the key to ensuring members are carrying out their role in accomplishing the task.

ACTIVITY**OBJECTIVE**

The objective of this activity is to untangle the “human knot” through teamwork.



This activity highlights the necessity for communication, mutual cooperation and support, including everyone and ensuring a better outcome, high esprit de corps and sharing a common goal.

RESOURCES

Nil.

ACTIVITY LAYOUT

Nil.

ACTIVITY INSTRUCTIONS

1. Divide the class into groups of approximately 10 cadets.
2. Direct each group to stand in a circle and place their right hand in the centre and take the hand of anyone except the person on either side of them.
3. Have them do the same with their left hands.
4. Explain to the cadets that they must not let go of their hands, and that their job is to work together to untangle the “Human Knot.”

SAFETY

Ensure the area where this activity is being conducted is flat and open so as to avoid any falls or collisions with other objects.

CONFIRMATION OF TEACHING POINT 1

The cadets’ participation in the activity will serve as the confirmation of this TP.

Teaching Point 2

Conduct the teambuilding activity “Memory.”

Time: 10 min

Method: In-Class Activity

ACTIVITY

OBJECTIVE

The objective of this activity is to remember as many of the items in the collage both as an individual and as a team.

RESOURCES

- Collage found in Attachment A.
- Overhead projector.
- Pens.
- Paper.
- Whiteboard/flip chart.
- Markers.

ACTIVITY LAYOUT

Nil.

ACTIVITY INSTRUCTIONS

1. Place a copy of the collage found in Attachment A on the OHP.
2. Turn the OHP on and have the cadets observe the overhead for 15 seconds.
3. After 15 seconds turn the OHP off and have the cadets individually write down as many items as they can recall.

4. After approximately two minutes record on the board/flipchart the number of items recalled on an individual basis.
5. Split the cadets into two groups and have them compile a group list of items they recall.
6. After two minutes compare the individual results to the group results.

SAFETY

Nil.

CONFIRMATION OF TEACHING POINT 2

The cadets' participation in the activity will serve as the confirmation of this TP.

Teaching Point 3

Conduct the teambuilding activity "Silent Birthdays."

Time: 10 min

Method: In-Class Activity

ACTIVITY

OBJECTIVE

The objective of this activity is to line up according to birthdays without speaking to one another.

RESOURCES

- Paper; and
- Pens.

ACTIVITY LAYOUT

Nil.

ACTIVITY INSTRUCTION

1. Direct the cadets to line up in birth order from oldest to youngest by not talking to one another.
2. If the task becomes daunting for the cadets provide a method to assist them (i.e. using pens and paper).
3. The pens and paper can be laid out on a table in the vicinity of the activity.
4. When the time is up, starting at the beginning of the line, have each cadet state his or her birthday to see if the task was successful.

SAFETY

Nil.

CONFIRMATION OF TEACHING POINT 3

The cadet's participation in the activity will serve as the confirmation of the TP.

Teaching Point 4

Lead a discussion on the characteristics of a successful team.

Time: 20 min

Method: Group Discussion

DISCUSSION QUESTIONS



TIPS FOR ANSWERING/FACILITATING DISCUSSION:

- Prepare questions ahead of time.
- Be flexible (you are not bound to only the prepared questions).
- Encourage cadets to participate by using praise such as “great idea” or “excellent response, can anyone add to that?”.
- Try to involve everyone by directing questions to non-participants.

SUGGESTED QUESTIONS:

- Q1. What advantages of teamwork were noticed while engaging in the activities?
- Q2. What things made the team successful in the activities?
- Q3. What things were frustrating throughout the activities?
- Q4. Why do you think teamwork is important?



Other questions and answers will develop throughout the reflection stage. The discussion should not be limited to only those suggested.

END OF LESSON CONFIRMATION

The cadets' participation in the activities will serve as the confirmation of the lesson.

CONCLUSION

HOMEWORK / READING / PRACTICE

Nil.

METHOD OF EVALUATION

Nil.

CLOSING STATEMENT

Teamwork is essential to a successful outcome. Knowing what skills contribute to the success of a team will aid in this. Development of these skills will occur each and every time an individual is involved in a team.

INSTRUCTOR NOTES / REMARKS

Nil.

REFERENCES

C0-003 ISBN 0-943210-44-5 Pike, B., & Busse, C. (1995). *101 more games for trainers*. Minneapolis, MN: Lakewood Publishing.

C0-004 ISBN 1-58062-577-0 McClain, G., & Romaine, D.S. (2002). *The everything managing people book*. Avon, MA: Adams Media.

C0-005 ISBN 0-07-046414-6 Scannell, E.E., & Newstrom, J. W. (1994). *Even more games trainers play*. New York: McGraw-Hill.

THIS PAGE INTENTIONALLY LEFT BLANK

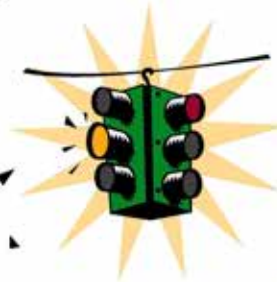

THIS PAGE INTENTIONALLY LEFT BLANK



**COMMON TRAINING
GREEN STAR
INSTRUCTIONAL GUIDE**



SECTION 4

EO C103.01 – PARTICIPATE IN ICEBREAKER ACTIVITIES

Total Time:

30 min

PREPARATION

PRE-LESSON INSTRUCTIONS

Resources needed for the delivery of this lesson are listed in the lesson specification located in A-CR-CCP-701/PG-001, *Green Star Qualification Standard and Plan*, Chapter 4. Specific uses for said resources are identified throughout the instructional guide within the TP for which they are required.

Review the lesson content and become familiar with the material prior to delivering the lesson.

Prepare all materials listed in the resource section of each activity.

PRE-LESSON ASSIGNMENT

Nil.

APPROACH

An in-class activity was chosen for TPs 1 to 3 as it is an interactive way to present icebreaker activities and the learning objective.

A group discussion was chosen for TP 4 as it allows the cadets to interact with their peers and share their knowledge, opinions and feelings about icebreaker activities.

INTRODUCTION

REVIEW

Nil.

OBJECTIVES

The cadet shall participate in icebreaker activities in order to become familiar with other cadets in the group.

IMPORTANCE

Introductions are vital to the success of any team. Cadets may be spending a long period of time together with each other throughout their involvement with the program. These activities will assist in developing positive relationships.

Teaching Point 1

Conduct the icebreaker activity “True Confession Toothpicks.”

Time: 5 min

Method: In-Class Activity

BACKGROUND KNOWLEDGE

ICEBREAKERS

Icebreakers are a method for getting cadets to introduce themselves. These exercises may vary according to the type of training being conducted, the size of the group, and how well the group members know each other. Icebreakers encourage self-disclosure, humour, respect for others, thought and creativity. Most importantly, they allow people to laugh at themselves.

ACTIVITY

OBJECTIVE

The objective of this activity is to assist cadets in getting to know each other by challenging participants to think creatively.

RESOURCES

- Large amount of toothpicks.

ACTIVITY LAYOUT

A circle classroom arrangement may be appropriate for this activity.

ACTIVITY INSTRUCTIONS

1. Give each cadet five toothpicks.
2. Select a cadet to go first; ask them to talk about something they have never done (eg. I have never jay-walked).
3. After the statement, anyone in the group who has done the action must forfeit a toothpick.
4. The next person then shares something they have never done. Again, someone who has done the action must forfeit a toothpick.
5. The disclosers continue until someone has lost all five toothpicks.

SAFETY

Nil.

CONFIRMATION OF TEACHING POINT 1

The cadets' participation in the activity will serve as the confirmation of this TP.

Teaching Point 2**Conduct the icebreaker activity “Two Truths and a Lie.”**

Time: 5 min

Method: In-Class Activity

ACTIVITY

OBJECTIVE

The objective of this activity is to get cadets thinking about differences and similarities between themselves and others.

RESOURCES

Nil.

ACTIVITY LAYOUT

Nil.

ACTIVITY INSTRUCTIONS

1. Divide cadets into groups of four;
2. Cadets will brainstorm three characteristics that make every cadet in the group the same;
3. Cadets will brainstorm three characteristics that make every cadet in the group different;
4. Each group of cadets peer share their similarities and their differences with the rest of the class.

SAFETYNil.

CONFIRMATION OF TEACHING POINT 2

The cadets' participation in the activity will serve as the confirmation of this TP.

Teaching Point 3**Conduct the icebreaker activity “Self Disclosure Introductions.”**

Time: 5 min

Method: In-Class Activity

ACTIVITY

OBJECTIVE

The objective of this activity is to provide innovative ways for the cadets to know one another by adding adjectives to their first or last names.

RESOURCES

Nil.

ACTIVITY LAYOUT

Nil.

ACTIVITY INSTRUCTION

Direct cadets to state their first or last name with an adjective put in front. The adjective should describe a dominant characteristic and start with the first letter of the first or last name. For example: Serious Stan, Mathematical Mary.

SAFETY

Nil.

CONFIRMATION OF TEACHING POINT 3

The cadet's participation in the activity will serve as the confirmation of the TP.

Teaching Point 4

Lead a group discussion on the effectiveness of the icebreakers in introducing themselves to each other.

Time: 10 min

Method: Group Discussion

DISCUSSION QUESTIONS



TIPS FOR ANSWERING/FACILITATING DISCUSSION:

- Prepare questions ahead of time.
- Be flexible (you are not bound to only the prepared questions).
- Encourage cadets to participate by using praise such as “great idea” or “excellent response, can anyone add to that?”.
- Try to involve everyone by directing questions to non-participants.

SUGGESTED QUESTIONS:

Q1. Did the tasks help you introduce yourselves to one another?

Q2. Did the activity help include everyone in the team environment?

Q3. How did you feel about the others in the group after the activity was completed?



Other questions and answers will develop throughout the reflection stage. The discussion should not be limited to only those suggested.

END OF LESSON CONFIRMATION

The cadets' participation in the activities will serve as the confirmation of the lesson.

CONCLUSION

HOMEWORK / READING / PRACTICE

Nil.

METHOD OF EVALUATION

Nil.

CLOSING STATEMENT

Introductions are vital to the success of any team. Cadets may be spending a long period of time together through their involvement with the program. These activities will assist in developing positive relationships.

INSTRUCTOR NOTES / REMARKS

Nil.

REFERENCES

C0-003 ISBN 0-943210-44-5 Pike, B and Busse, C. (1995). *101 More games for trainers*. Minneapolis, MN: Lakewood Books

C0-028 ISBN 0-07-046513-4 Newstrom, J and Edward, S. (1998). *The big book of teambuilding games*. New York, NY: McGraw-Hill.

THIS PAGE INTENTIONALLY LEFT BLANK



**COMMON TRAINING
GREEN STAR
INSTRUCTIONAL GUIDE**



SECTION 5

EO C103.02 – PARTICIPATE IN SELF INTRODUCTIONS

Total Time:

30 min

PREPARATION

PRE-LESSON INSTRUCTIONS

Resources needed for the delivery of this lesson are listed in the lesson specification located in A-CR-CCP-701/PG-001, *Green Star Qualification Standard and Plan*, Chapter 4. Specific uses for said resources are identified throughout the instructional guide within the TP for which they are required.

Review the lesson content and become familiar with the material prior to delivering the lesson.

Prepare all materials listed in the resource section of each activity.

PRE-LESSON ASSIGNMENT

Nil.

APPROACH

An in-class activity was chosen for TP 1 as it is an interactive way to reinforce self-introductions and to provoke thought and stimulate interest among cadets.

A group discussion was chosen for TP2 as it allows the cadets to interact with their peers and share their knowledge, opinions and feelings about self-introductions.

INTRODUCTION

REVIEW

Nil.

OBJECTIVES

The cadet shall introduce themselves to the group.

IMPORTANCE

Communication is an important aspect of leadership. Being able to communicate with other members of the group and the leader will lead to successful completion of tasks. Starting with a short, informal introduction will give the cadets confidence to start developing their communication skills.

Teaching Point 1**Conduct a self-introduction activity.**

Time: 15 min

Method: Interactive Lecture

BACKGROUND KNOWLEDGE

COMMUNICATION

Effective communication skills are key to any successful group or team and are an important factor in becoming an effective leader. A leader who can communicate effectively with the team will move the team towards a positive outcome.

Communication works in both directions. When one person is delivering a message, the team members must be listening to ensure they receive the message correctly. Part of becoming a leader is developing good listening skills. Team members should feel comfortable enough to bring forth ideas to the leader and feel that their ideas are heard and taken into account.

ACTIVITY

OBJECTIVE

The objective of this activity is to have each of the cadets present themselves to the class.

RESOURCES

- White board with markers;
- Pens; and
- Paper.

ACTIVITY LAYOUT

If the class is big, divide the group into smaller groups and use assistant instructors to facilitate the introductions.

ACTIVITY INSTRUCTIONS

1. Have each cadet stand in front of the class and present a short introduction.
2. The introduction should include information such as:
 - (a) their name;
 - (b) what school they attend;
 - (c) what grade they are in;
 - (d) why they joined cadets;
 - (e) their hobbies;
 - (f) their interests; and
 - (g) their general career ambitions.
3. Write this list on the board for the cadets to reference during the introduction.

4. Give the cadets two minutes to write some notes to use during the introduction.
5. Each introduction should be no more than two minutes in length.

SAFETY

Nil.

CONFIRMATION OF TEACHING POINT 1

The cadets' participation in the activity will serve as the confirmation of this TP.

Teaching Point 2

Lead a discussion on the importance of the self-introduction activity in regards to developing communication skills.

Time: 10 min

Method: Group Discussion

DISCUSSION QUESTIONS



TIPS FOR ANSWERING/FACILITATING DISCUSSION:

- Prepare questions ahead of time.
- Be flexible (you are not bound to only the prepared questions).
- Encourage cadets to participate by using praise such as “great idea” or “excellent response, can anyone add to that?”.
- Try to involve everyone by directing questions to non-participants.

SUGGESTED QUESTIONS:

- Q1. How does this exercise emphasize the importance of communication?
- Q2. Why is communication important in a team setting?
- Q3. What feelings were experienced while introducing yourself?



Other questions and answers will develop throughout the reflection stage. The discussion should not be limited to only those suggested.

END OF LESSON CONFIRMATION

The cadets' participation in the activities will serve as the confirmation of the lesson.

CONCLUSION

HOMEWORK / READING / PRACTICE

Nil.

METHOD OF EVALUATION

Nil.

CLOSING STATEMENT

Being able to communicate with others is essential in leadership both as a follower and a leader. Participating in self-introductions will give the cadet confidence to communicate with others in the group and with the leader.

INSTRUCTOR NOTES / REMARKS

Nil.

REFERENCES

C0-021 ISBN 1-58062-513-4 Adams, B. (2001). *The everything leadership book*. Avon, MA: Adams Media.



**COMMON TRAINING
GREEN STAR
INSTRUCTIONAL GUIDE**



SECTION 6

EO C103.03 – PARTICIPATE IN TEAMBUILDING ACTIVITIES

Total Time:

30 min

PREPARATION

PRE-LESSON INSTRUCTIONS

Resources needed for the delivery of this lesson are listed in the lesson specification located in A-CR-CCP-701/PG-001, *Green Star Qualification Standard and Plan*, Chapter 4. Specific uses for said resources are identified throughout the instructional guide within the TP for which they are required.

Review the lesson content and become familiar with the material prior to delivering the lesson.

Prepare all materials listed in the resource section of each activity.

PRE-LESSON ASSIGNMENT

Nil.

APPROACH

An in-class activity was chosen for TPs 1 and 3 as it is an interactive way to present team building activities and the learning objective.

A group discussion was chosen for TPs 2 and 4 as it allows the cadet to interact with their peers and share their knowledge, opinions and feelings about teamwork.

INTRODUCTION

REVIEW

Nil.

OBJECTIVES

The cadet shall participate in teambuilding activities and discuss the characteristics and advantages of a successful team.

IMPORTANCE

Acquiring the skills needed to work as an effective team member is essential to achieving the team's goals.

Teaching Point 1**Conduct the teambuilding activity “Jigsaw.”**

Time: 5 min

Method: In-Class Activity

BACKGROUND KNOWLEDGE

CHARACTERISTICS OF A SUCCESSFUL TEAM

- Communication – Clear communication is essential to an effective team. Team members must feel comfortable sharing ideas and concerns with each other and the leader.
- Mutual cooperation and support – It is hard to be innovative when you are not sure how others will react to your ideas. Team members must be aware that even if people disagree the objection is to the idea, not to the person presenting it. Members of a team must have the right to a certain level of trust that precludes backstabbing, gossip and negative behaviours aimed solely at making someone look bad.
- Share a common goal – When a team understands the purpose for a task they have a heightened motivation to work together towards the completion of it.
- High esprit de corps – When each member of the team has a sense of pride and belonging to the team, it is more likely they will want to be part of the team. This sense of belonging will enable the group to become more cohesive and willing to work together to accomplish the task.

ADVANTAGES OF EFFECTIVE TEAMWORK

- Includes everyone and ensures a better outcome – In a team setting people feel that their contributions are valuable. A strong group performance is generated from strong individual efforts. When many individuals are working together to accomplish a task different ideas and opinions mesh together to provide a sound outcome.
- Tasks are easier when more people are involved – When the responsibility and workload are shared among the team members and the team works together to ensure everyone stays on track, the team will offer support to those who need it.
- Increases and develops communication – Teamwork is an opportunity for people to interact in new ways by forming relationships and communicating with new people. Communication is the key to ensuring members are carrying out their role in accomplishing the task.

ACTIVITY

OBJECTIVE

The objective of this activity is to stress the importance of each team member’s individual contributions and the importance of working as a group.

RESOURCES

- One previously constructed picture puzzle, divided into sets of approximately 10 pieces per participant, broken apart and allocated to each cadet for re-assembly;
- CD player (optional); and
- Appropriate CDs (optional).

ACTIVITY LAYOUT

Nil.

ACTIVITY INSTRUCTIONS

1. Select a suitable picture puzzle (Attachment A).
2. Break the puzzle into nine connectable subsets (so the subsets can be connected to each other)
3. Distribute the subsets to each participant (divide cadets into groups if there are more than 9 participants).
4. Have the cadets assemble the subsets of the puzzle.
5. After the subsets are assembled, have the cadets come together to join the subsets and form the full picture.
6. Set a challenging time limit for the activity and play energizing music to create a sense of urgency.

SAFETY

Nil.

CONFIRMATION OF TEACHING POINT 1

The cadets' participation in the activity will serve as the confirmation of this TP.

Teaching Point 2

Lead a discussion on how the cadets viewed the Jigsaw game in terms of how it fostered teamwork.

Time: 5 min

Method: Group Discussion

DISCUSSION QUESTIONS**TIPS FOR ANSWERING/FACILITATING DISCUSSION:**

- Prepare questions ahead of time.
- Be flexible (you are not bound to only the prepared questions).
- Encourage cadets to participate by using praise such as “great idea” or “excellent response, can anyone add to that?”.
- Try to involve everyone by directing questions to non-participants.

SUGGESTED QUESTIONS:

- Q1. What was your reaction were experienced when you realized your importance to the overall team?
- Q2. What impact did the time deadline have on the effectiveness the group completing the task?
- Q3. What was the impact of having team members available to help with the task?
- Q4. What do you feel the completed picture puzzle represents?
- Q5. Ask the cadets to consider both their productive and counterproductive behaviours. It is likely that they are using the same behaviours in actual team environments, with similar positive and negative effects.

CONFIRMATION OF TEACHING POINT 2

The cadets' participation in the group discussion will serve as the confirmation of this TP.

Teaching Point 3

Conduct the teambuilding activity "Alphabetically."

Time: 10 min

Method: In-Class Activity

ACTIVITY

OBJECTIVE

The objective of this activity is to stress the importance of each team member's individual contributions and the importance of working as a group.

RESOURCES

- Blindfolds (optional)

ACTIVITY LAYOUT

Nil.

ACTIVITY INSTRUCTION

1. Begin with the cadets sitting or standing in random locations throughout the activity area with their eyes closed (or blindfolds on).
2. Direct one cadet to say the first letter of the alphabet.
3. The remainder of the cadets must now state the remaining letters in order without ever having two cadets saying the same letter at the same time.

SAFETY

Nil.

CONFIRMATION OF TEACHING POINT 3

The cadet's participation in the activity will serve as the confirmation of the TP.

Teaching Point 4**Lead a discussion on the characteristics of a successful team.**

Time: 20 min

Method: Group Discussion

DISCUSSION QUESTIONS**TIPS FOR ANSWERING/FACILITATING DISCUSSION:**

- Prepare questions ahead of time.
- Be flexible (you are not bound to only the prepared questions).
- Encourage cadets to participate by using praise such as “great idea” or “excellent response, can anyone add to that?”.
- Try to involve everyone by directing questions to non-participants.

SUGGESTED QUESTIONS:

- Q1. Did the group try to use any non-verbal clues to determine the order within the group? If so, what were they and did they assist in completing the task?
- Q2. What makes this activity so difficult?
- Q3. If a pattern was created, was the activity then easier to complete?
- Q4. Was the activity easier to complete with eyes open? If so, why?
- Q5. How did you feel about the individual contribution that each cadet made?



Other questions and answers will develop throughout the reflection stage. The discussion should not be limited to only those suggested.

END OF LESSON CONFIRMATION

The cadets' participation in the activities will serve as the confirmation of the lesson.

CONCLUSION

HOMEWORK / READING / PRACTICE

Nil.

METHOD OF EVALUATION

Nil.

CLOSING STATEMENT

Teamwork is essential to the outcome of a group task. Knowing what skills contribute to the success of a team will aid in a positive outcome. Development of these skills will occur each and every time an individual is involved in a team.

INSTRUCTOR NOTES / REMARKS

Nil.

REFERENCES

C0-028 ISBN 0-07-046513-4 Newstrom, J and Scannell, E. (1998). *The big book of teambuilding games*. New York, NY: McGraw-Hill.

C0-029 ISBN 0-7872-4532-1 Cain, J and Jolliff, B. (1998). *Teamwork and teamplay*. Brockport, NY: Kendall/Hunt.

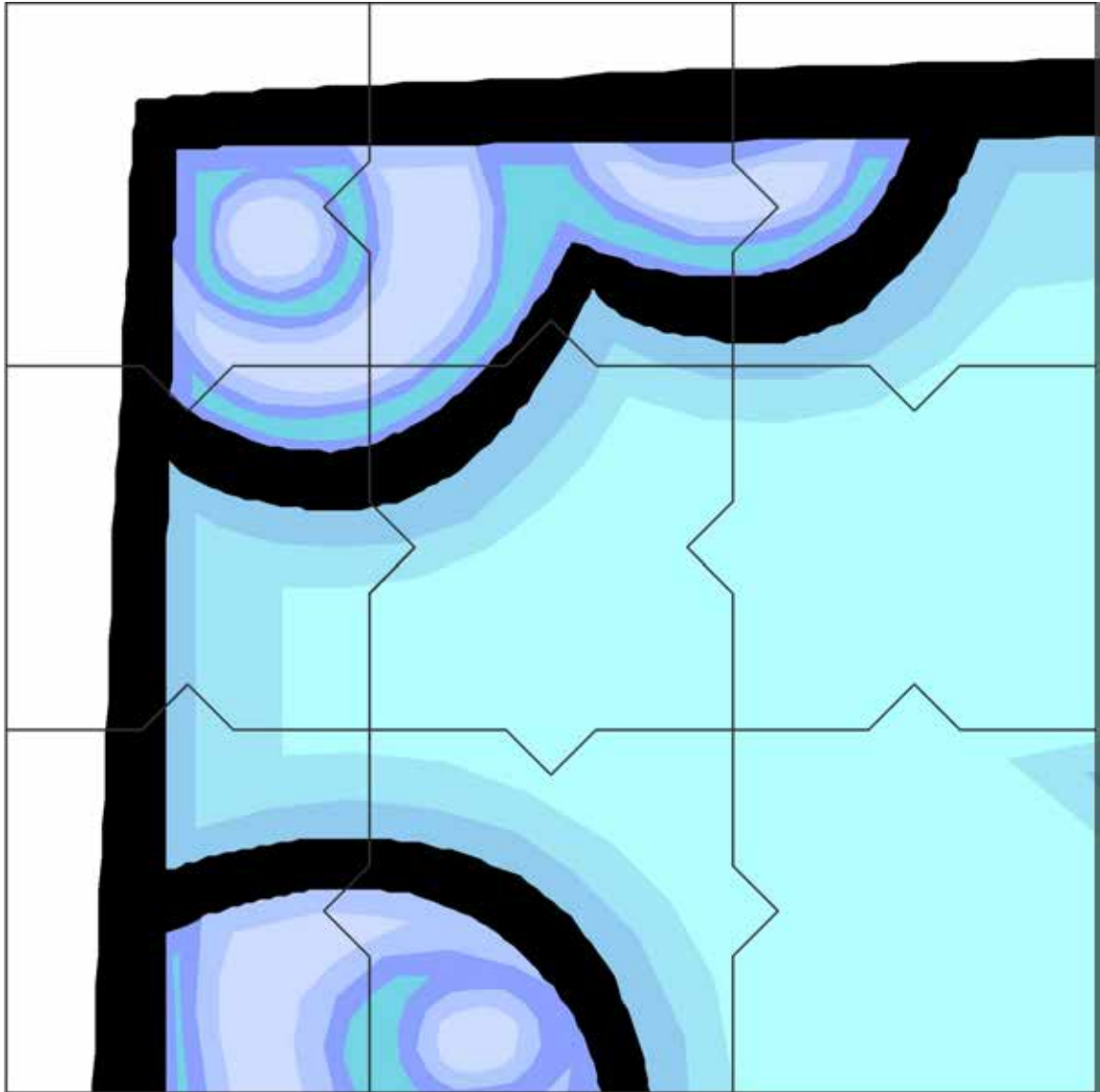



CHAPTER 4

PO X04 – TRACK PARTICIPATION IN PHYSICAL ACTIVITIES



**COMMON TRAINING
ALL TRAINING LEVELS
INSTRUCTIONAL GUIDE
PERSONAL FITNESS
AND HEALTHY LIVING**



SECTION 1

**EO MX04.01 – PARTICIPATE IN 60 MINUTES OF MODERATE- TO VIGOROUS-INTENSITY
PHYSICAL ACTIVITY (MVPA) AND TRACK PARTICIPATION IN PHYSICAL ACTIVITIES**

Total Time:

One session (3 periods) = 90 min

PREPARATION

PRE-LESSON INSTRUCTIONS

This IG supports EO MX04.01 (Participate in 60 Minutes of Moderate- to Vigorous-Intensity Physical Activity [MVPA] and Track Participation in Physical Activities) located in A-CR-CCP-701/PG-001, *Royal Canadian Army Cadets, Green Star Qualification Standard and Plan*, Chapter 4.

Review the warm-up and cool-down located at Annexes A and B.

Select a Cardio Activity for TP 1 as per Annex C.

Assign instructors for Learning Stations 1, 2, 3, and 4 located at Annexes D, E, F and G respectively.

Photocopy the Physical Activity Tracker located at Annex H for each cadet.

Gather the required resources:

- Activity posters / tape / whistle or Instructor Guide / stopwatch as per selected cardio activity,
- Music and music player,
- *Canadian Physical Activity Guidelines for Youth* located at Annex D, Appendix 1 (one copy per Green Star cadet),
- *Canadian Sedentary Behaviour Guidelines* located at Annex D, Appendix 2 (one copy per Green Star cadet),
- The Three Components of Physical Fitness located at Annex D, Appendix 3 (one copy),
- *Eating Well with Canada's Food Guide* (one copy per Red Star team),
- Chairs (one per Silver Star cadet),
- Flipchart paper (one sheet per Silver Star team),
- Pens / pencils,
- Markers (one per Silver Star team),
- Healthy Lifestyle Tool Belt handout located at Annex G, Appendix 1 (one copy per Gold Star cadet), and
- Physical Activity Tracker located at Annex H (one per cadet).

Cut out the Three Components of Physical Fitness, so the three components are separated.

Create the Jeopardy Game Board for Learning Station 2.

PRE-LESSON ASSIGNMENT

Nil.

APPROACH

A practical activity was chosen for TP 1 as it is a fun and interactive way to stimulate interest in physical activities.

An in-class activity was chosen for TPs 2 and 4 as it is a fun and interactive way to stimulate interest in personal fitness and healthy living and in ways to improve participation in physical activity.

An interactive lecture was chosen for TP 3 to orient the cadets to the Physical Activity Tracker requirements.

INTRODUCTION

REVIEW

Nil.

OBJECTIVES

By the end of this session the cadets shall have participated in 60 minutes of MVPA, have participated in a personal fitness and healthy living learning station, and have learned the requirements for tracking MVPA time over a four-week period.

IMPORTANCE

It is important for cadets to participate in this lesson as it will give them tools to be more active and to track their participation in physical activity. Tracking participation in physical activities will make them aware of how much time they spend being physically active. Becoming more physically active and less sedentary will help cadets avoid long-term health issues related to inactivity.

Teaching Point 1**Have the cadets participate in 60 minutes of MVPA.**

Time: 60 min

Method: Practical Activity

BACKGROUND KNOWLEDGE

THE WARM-UP**Purpose of a Warm-Up**

A warm-up session is composed of light cardiovascular exercises and stretches designed to:

- gradually increase respiratory action and heart rate;
- raise the muscle temperature to facilitate reactions in muscle tissue; and
- stretch the muscles.

The warm-up prepares the cardiovascular system for the physical activity. It is composed of activities such as brisk walking, light jogging, or simple games that elevate the heart rate. As a guide, allow 10 minutes to warm up for every hour of physical activity.

THE COOL-DOWN**Purpose of a Cool-Down**

A cool-down is composed of light cardiovascular exercises and stretches designed to:

- allow the body time to slowly recover from physical activity and to help prevent injury;
- prepare the respiratory system to return to its normal state; and
- stretch the muscles to help relax and restore them to their resting length.

Guidelines for Stretching

The following guidelines should be followed while stretching:

- Stretch all major muscle groups, including the back, chest, legs, and shoulders.
- Never bounce while stretching.
- Hold each stretch for 10–30 seconds to let the muscles release fully.
- Repeat each stretch two to three times.
- When holding a stretch, support the limb at the joint.

ACTIVITY

1. Conduct a warm-up as per Annex A.
2. Conduct the selected Cardio Activity for all cadets in Training Levels 1–4 as per Annex C.
3. Conduct the cool-down as per Annex B.

Teaching Point 2**Have the cadets participate in learning stations.**

Time: 20 min

Method: In-Class Activity

1. Divide the cadets into their training levels.
2. Conduct the four learning stations concurrently, as per Annexes D, E, F, and G:
 - (a) Phase One / Green Star / Proficiency Level One: *Canadian Physical Activity Guidelines* and *Canadian Sedentary Behaviour Guidelines*,
 - (b) Phase Two / Red Star / Proficiency Level Two: Nutrition,
 - (c) Phase Three / Silver Star / Proficiency Level Three: Stress, and
 - (d) Phase Four / Gold Star / Proficiency Level Four: Healthy Lifestyle Tool Belt.

Teaching Point 3**Explain Physical Activity Tracker requirements.**

Time: 5 min

Method: Interactive Lecture



Distribute the Physical Activity Tracker located at Annex H.

PHYSICAL ACTIVITY TRACKER REQUIREMENTS

- Phases One and Two / Green and Red Stars / Proficiency Levels One and Two: Track participation in MVPA over a period of four consecutive weeks;
- Phase Three / Silver Star / Proficiency Level Three: achieve a minimum of 60 minutes of MVPA daily for at least 16 days over four consecutive weeks;
- Phase Four / Gold Star / Proficiency Level Four: achieve a minimum of 60 minutes of MVPA daily for at least 20 days over four consecutive weeks; and
- Phase Five / Master Cadet / Proficiency Level Five: achieve a minimum of 60 minutes of MVPA daily for at least 24 days over four consecutive weeks.

Teaching Point 4**Conduct an activity on strategies to improve participation in physical activities.**

Time: 5 min

Method: In-Class Activity

ACTIVITY

1. Ask the cadets: What strategies can you use to improve participation in physical activity?
2. Allow two minutes for cadets to individually list as many strategies as they can.
3. Ask the cadets to share items they have listed and explain why they are strategies for them.



Examples of strategies to improve participation in physical activities include:

- identifying enjoyable activities;
- finding an activity partner;
- tracking progress;
- joining a community or school recreational program;
- setting goals;
- trying a new physical activity;
- building physical activity into daily routine; and
- planning for physical activity.

CONCLUSION

METHOD OF EVALUATION

Nil.

CLOSING STATEMENT

It is important for cadets to participate in moderate- to vigorous-intensity physical activity as it will help them meet the *Canadian Physical Activity Guidelines*. Additionally, participating in personal fitness and healthy living learning stations will help them gain knowledge and skills that they can use throughout their lives.

INSTRUCTOR NOTES / REMARKS

There are numerous potential leadership opportunities for cadets when conducting these learning stations:

- Phase Five / Master Cadet / Proficiency Level Five cadets may plan, prepare and conduct the learning stations activity as a leadership project IAW PO 503 (Lead Cadet Activities); and
- Phase Three / Silver Star / Proficiency Level Three, Phase Four / Gold Star / Proficiency Level Four, and Phase Five / Master Cadet / Proficiency Level Five cadets may complete leadership assignments, such as leading or supervising individual learning stations, IAW POs 303 (Perform the Role of a Team Leader), 403 (Act as a Team Leader), and 503 (Lead Cadet Activities).

REFERENCES

Canadian Society for Exercise Physiology. (2013). *Guidelines*. Retrieved from: <http://www.csep.ca>

Health Canada. (2013). *Physical Activity*. Retrieved from: <http://www.hc-sc.gc.ca/hl-vs/physactiv/index-eng.php>

ParticipACTION. (2011). *Get moving*. Retrieved from: www.participaction.com/en-us/Get-Moving/Easy-Ways-To-Start.aspx

THIS PAGE INTENTIONALLY LEFT BLANK

WARM-UP

WARM-UP MOVEMENTS

1. Have the cadets get into a formation (eg, circle or half-circle) so they can all see the instructor.
2. Demonstrate and have the cadets complete the movements below for 30 seconds each.



Focus more on full range of motion of joints and muscles (and less on stretching).

3. Have the cadets complete continuous cardiovascular movements (eg, jogging, fast walking or skipping) for five minutes.









<p>1.</p>  <p>Jumping Jacks</p>	<p>2.</p>  <p>Butt Kicks</p>	<p>3.</p>  <p>High Knee Grab</p>
<p>4.</p>  <p>Hip Rotations</p>	<p>5.</p>  <p>Jumping Squats</p>	<p>6.</p>  <p>Trunk Rotations</p>
<p>7.</p>  <p>Shoulder Rotations</p>	<p>8.</p>  <p>Wrist Rotations</p>	<p>9.</p>  <p>Ankle Rotations</p>

Figure A-1 Instructor Guide

THIS PAGE INTENTIONALLY LEFT BLANK

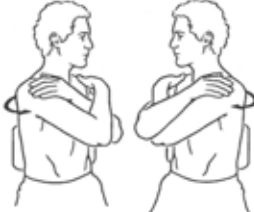

 <p>Figure A1-1 Jumping Jacks</p>	<p>Stand with your hands by your sides. Jump up, swing your arms up to meet above your head while spreading your feet shoulder width apart and landing softly back on the ground.</p> <p>Jump back into the starting position.</p> <p>Repeat the alternating jumps continuously.</p>
 <p>Figure A1-2 Butt Kicks</p>	<p>Jog in place while trying to touch your buttocks with your heels.</p>
 <p>Figure A1-3 High Knee Grab</p>	<p>Keeping your body straight, bring one knee up to your chest, holding it in place with your hands for 5 seconds.</p> <p>Return to the standing position, and repeat with the other knee.</p> <p>Continue alternating between both knees.</p>



Figure A1-4 Hip Rotations

Keep your shoulders square and centered over your feet, with feet planted on the floor.

Place your hands on your hips and rotate your hips in a clockwise direction in large circles. Change direction after 15 seconds.



Figure A1-5 Jumping Squats

Bend your knees to a sitting position (don't let your knees go past your toes), then jump up. Land lightly on the balls of your feet.

Keep your back straight throughout the exercise.

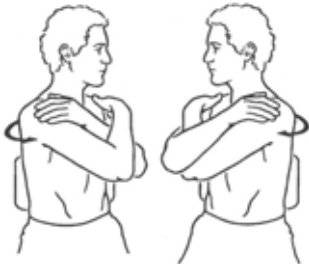

Figure A1-6 Trunk Rotations

Cross your arms over your chest and rotate slowly in one direction until you feel the stretch.

Be careful not to over extend this movement.

Alternate between both sides.



Figure A1-7 Shoulder Rotations

Slowly swing your arms forward in small circles, gradually getting larger.

Repeat in the other direction.



Figure A1-8 Wrist Rotations

Rotate both hands in circular motions at the wrist.
Rotate in both directions.



Figure A1-9 Ankle Rotations

Keeping your foot off the floor, rotate your foot
in one direction, and then the opposite direction.
Switch and repeat on the opposite side.

THIS PAGE INTENTIONALLY LEFT BLANK

COOL-DOWN

ACTIVITY INSTRUCTIONS

1. Have the cadets get into a formation (eg, circle, half-circle) so they can all see the instructor.
2. Have the cadets complete the following movements. Supervise and correct technique as required.





1.  NECK ROLLS	2.  SHOULDER PUSH	3.  SHOULDER SHRUG
4.  ARM CIRCLES	5.  SHOULDER STRETCH	6.  WRIST ROTATIONS
7.  TRICEP STRETCH	8.  FOREARM STRETCH	9.  CHEST STRETCH
10.  SIDE STRETCH	11.  LOWER BACK STRETCH	12.  UPPER BACK STRETCH
13.  HAMSTRING STRETCH	14.  INNER THIGH STRETCH	15.  HIP FLEXOR
16.  ANKLE ROTATIONS	17.  CALF STRETCH	18.  QUADRICEPS STRETCH

Figure B-1 Instructor Guide

THIS PAGE INTENTIONALLY LEFT BLANK

SAMPLE STRETCHES





 <p>Figure B1-1 Neck Stretch</p>	<p>Slowly roll your head across your chest from shoulder to shoulder. Do not roll your head backwards.</p>
 <p>Figure B1-2 Shoulder Push</p>	<p>Stand and extend your arms behind you, interlocking your fingers. Push up and back with your shoulders. Hold this position for a minimum of 10 seconds.</p>
 <p>Figure B1-3 Shoulder Shrug</p>	<p>Stand and raise your shoulders as high as possible and then lower your shoulders, stretching your neck up. Pull your shoulders back as far as possible and then round your shoulders forward by pushing your shoulders forward as far as possible. Hold each position for a minimum of 10 seconds.</p>
 <p>Figure B1-4 Arm Circles</p>	<p>Hold your arms straight out, palms up. Make small circles with your arms, gradually increasing the size. Reverse the direction of your circles.</p>

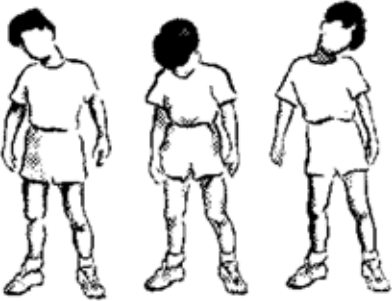

Figure B1-5 Shoulder Stretch

Either standing or sitting, take your right arm in your left hand and bring it across your chest, supporting the joint by holding it behind the elbow. Pull lightly on the elbow towards your chest. You should feel the stretch in your right shoulder.

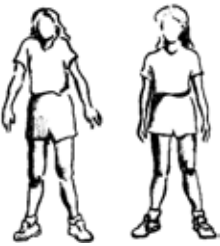
Hold this position for a minimum of 10 seconds and repeat on the opposite side.



Figure B1-6 Wrist Rotations

Rotate your hands in circular motions at the wrist.

Change direction and repeat on both sides.



Figure B1-7 Triceps Stretch

Stand and bring your right arm over your head, bent at the elbow. Use your left hand to gently pull your arm down.

Hold this position for a minimum of 10 seconds and repeat on the opposite side.



Figure B1-8 Forearm Stretch

In a kneeling position, place your hands on the floor in front of you turned so that your fingers are pointing toward your knees, and your thumbs are pointing out. Keeping your hands flat on the floor, lean back.

Hold this position for a minimum of 10 seconds.



 <p>Figure B1-9 Chest Stretch</p>	<p>Stand facing a wall. With your right arm bent and your elbow at shoulder height, place your palm against the wall. Turn your body away from your right arm. You should feel the stretch on the front side of your armpit and across the front of your chest.</p> <p>Hold this position for a minimum of 10 seconds and repeat on the opposite side.</p>
 <p>Figure B1-10 Side Stretch</p>	<p>Stand with your left arm up over your head. Bend at your waist towards the right side of your body.</p> <p>Hold this position for a minimum of 10 seconds and repeat on the opposite side.</p>
 <p>Figure B1-11 Lower Back Stretch</p>	<p>Lie on your back and bring your knees toward your chest. Grasp the back of your knees.</p> <p>Hold this position for a minimum of 10 seconds.</p>
 <p>Figure B1-12 Upper Back Stretch</p>	<p>Extend your arms straight in front of you at shoulder height crossing one arm over the other. With the palms facing each other, intertwine your fingers and press out through your arms. Let your chin fall to your chest as you exhale. You should feel the stretch in the upper back.</p> <p>Hold this position for a minimum of 10 seconds and repeat on the opposite side.</p>



Figure B1-13 Hamstring Stretch

Lie flat on the floor with your knees bent and your back flat on the floor. Slowly raise and straighten one leg, grasping it behind your thigh with both hands.

Hold this position for a minimum of 10 seconds.

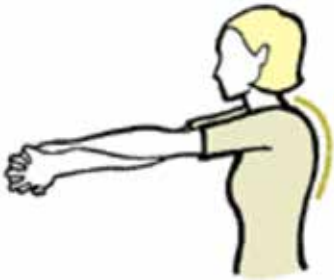

Figure B1-14 Inner Thigh Stretch

Sit on the floor with your knees bent and the soles of your feet together. Grab your toes and pull yourself forward while keeping your back and neck straight.

Hold this position for a minimum of 10 seconds.

Grab your ankles and push your knees down toward the floor with your elbows.

Hold this position for a minimum of 10 seconds.



Figure B1-15 Hip Flexor

Kneel on your right knee. Position your left foot in front of you, bending your knee and placing your left hand on that leg for stability. Keep your back straight and abdominal muscles tight. Lean forward, shifting more body weight onto your front leg. You should feel the stretch in the front of your hip and the thigh of the leg you are kneeling on. Cushion your kneecap with a folded towel if necessary.

Hold this position for a minimum of 10 seconds and repeat on the opposite side.



Figure B1-16 Ankle Rotations

From a sitting position, rotate your foot in a clockwise, and then a counter-clockwise, direction.

Switch and repeat on the opposite side.



Figure B1-17 Calf Stretch

Stand three steps away from and facing a wall. Step in towards the wall with your right leg, bending your right knee and keeping your left leg straight. Extending your arms with your palms forward, reach out to the wall and let your body fall toward the wall. Keep your toes forward and your heels down. Lean your body into the wall with your left leg straight behind your body. You should feel the stretch in your left calf.

Hold this position for a minimum of 10 seconds and repeat on the opposite side.



Figure B1-18 Quadriceps Stretch

Stand with your hand against a wall for balance. Lift your left foot off the ground, bending your knee as if you are trying to kick your bottom with your heel. Do not lean forward at the hips. Grab and hold your ankle with your left hand. You should feel the stretch in your left thigh.

Hold this position for a minimum of 10 seconds and repeat on the opposite side.

THIS PAGE INTENTIONALLY LEFT BLANK

CARDIO ACTIVITY OPTION 1: CIRCUIT TRAINING

OBJECTIVE: This activity is designed to raise awareness of exercises that can be used to achieve sustained moderate- to vigorous-intensity physical activity.

TIME: 40 min

TRAINING LEVEL: 1–4

PRE-ACTIVITY INSTRUCTIONS:

- Select 10 stations from the ones provided at Appendix 1.



Suggested circuits include:

- Stations 1–10;
- Stations 11–20; or
- Stations 21–30.

- Review the selected stations' descriptions located at Appendix 2.
- Assign an instructor and a demonstrator to this activity.
- Gather the required resources:
 - Activity posters for each of the selected stations located at Appendix 1,
 - Tape,
 - Stopwatch,
 - Whistle, and
 - Music.
- Prepare the circuit layout by taping activity posters in numerical order on the wall, at intervals, in a clockwise direction.
- Prepare the demonstrator by reviewing the activity stations and ensuring the demonstrator is using proper technique.

ACTIVITY INSTRUCTIONS:

1. Complete a "walk about" of the 10 stations, explaining the activity at each station to the cadets and highlighting the importance of proper technique while the demonstrator demonstrates the activity. Depending on the size of the corps / squadron this can be done as:
 - (a) one group with one instructor and one demonstrator,
 - (b) five groups with five instructors and five demonstrators, or
 - (c) ten groups with ten instructors and ten demonstrators.
2. Divide the cadets into 10 equal groups.

3. Give the cadets the following instructions:
 - (a) each station is 45 seconds with the start and stop time indicated by a whistle blow,
 - (b) 15 seconds to get to the next station,
 - (c) circuit will be done three times, and
 - (d) one minute rest and rehydration after the first and second completion of the circuit.
4. Supervise the cadets as they participate in the activity, correcting technique and providing encouragement.

CARDIO ACTIVITY OPTION 2: INSTRUCTOR-LED TRAINING

OBJECTIVE: This activity is designed to raise awareness of exercises that can be used to achieve sustained moderate- to vigorous-intensity physical activity.

TIME: 40 min

TRAINING LEVEL: 1–4

PRE-ACTIVITY INSTRUCTIONS:

- Assign an instructor to this activity. The instructor must be capable of leading a physical activity session. Recommended: Basic Fitness and Sports Course or Fitness and Sports Instructor Course cadet.
- Select one of the following options:
 - 1 round of (12 exercises x 3 min each) = 36 min
 - 2 rounds of (12 exercises x 1.5 min each) = 36 min
 - 3 rounds of (12 exercises x 1 min each) = 36 min
 - A combination of timings per exercise that totals 36 min
- Select one of the suggested Instructor Guide located at Appendix 3.
- Review the selected stations' descriptions located at Appendix 2.
- Gather the required resources:
 - Selected Instructor Guide located at Appendix 3,
 - Stopwatch, and
 - Music.

ACTIVITY INSTRUCTIONS:

1. Have the cadets spread out so that they have room to move.
2. Using the Instructor Guide, lead the cadets through the list of 12 physical activities, as per selected option above.
3. Provide water breaks and rest breaks between rounds, or as required.
4. Supervise, correct technique and provide encouragement throughout.

THIS PAGE INTENTIONALLY LEFT BLANK

STATION 1: BICYCLE LEGS



	<p>Keep core tight to protect your back. Do not pull on your head with your hands.</p>
↓ challenge	Place your hands on the floor beside your hips to help balance.

STATION 2: PUSH-UPS

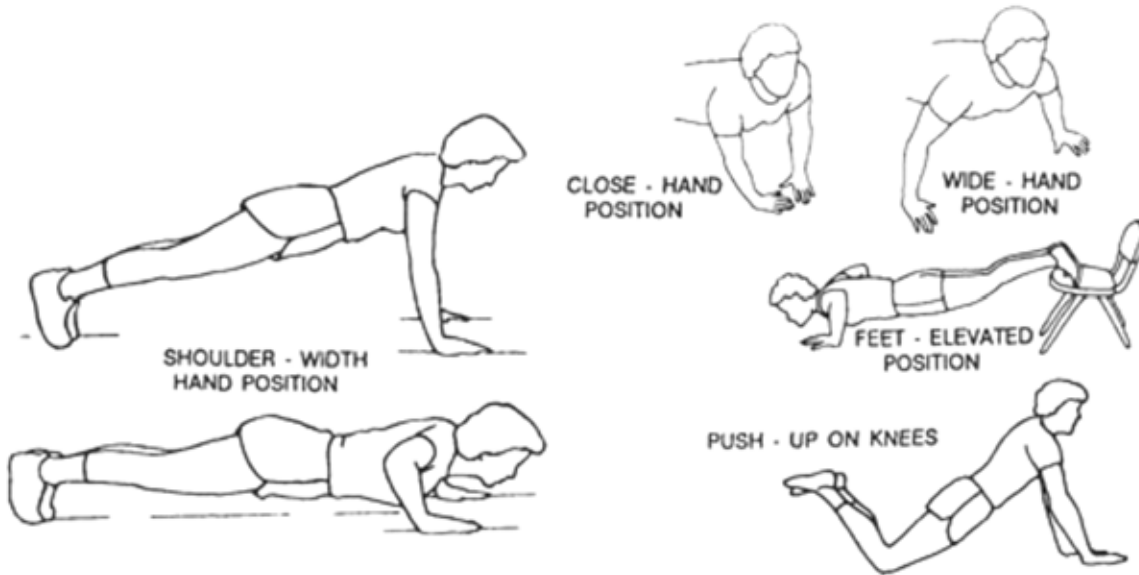

	Keep your body in a straight line.
↓ challenge	Place your knees on the floor.
↑ challenge	Move your hands closer together.

STATION 3: STAR JUMPS

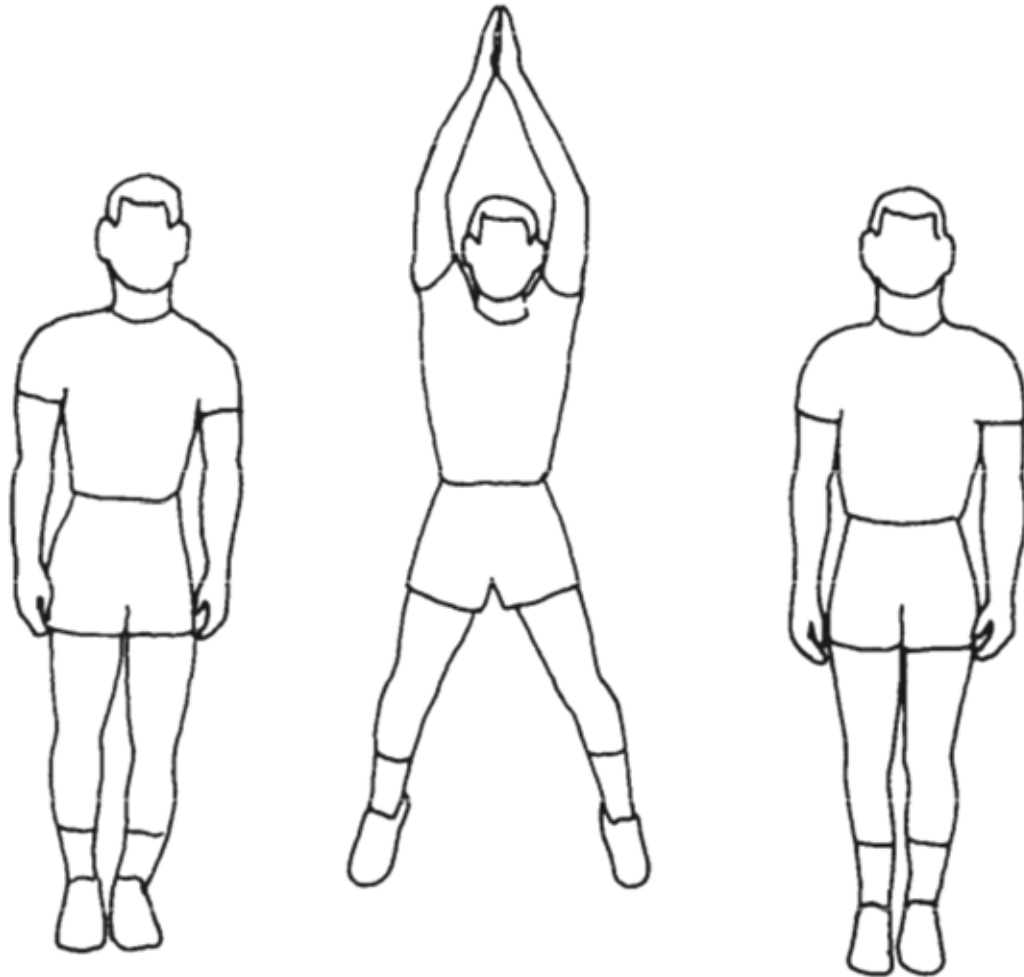

	Land with your knees slightly bent.
↓ challenge	Step between movements instead of jumping.

STATION 4: CURL-UPS

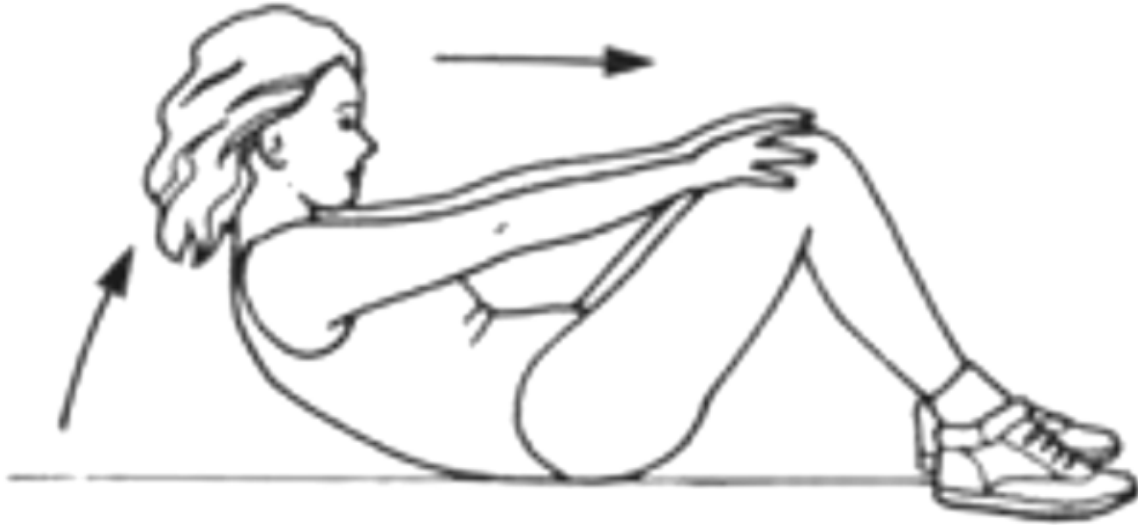

	Keep lower back and feet on the floor.
↓ challenge	Move your feet closer to your buttocks.
↑ challenge	Move your feet away from your buttocks.

STATION 5: FROG JUMPS

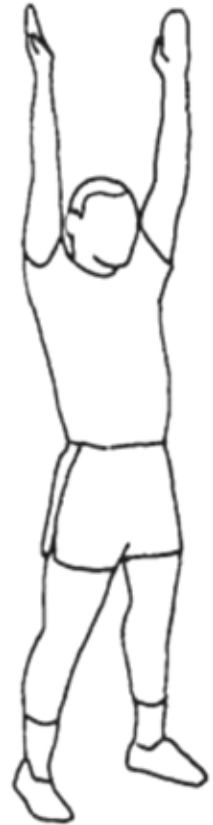

	<p>Keep knees slightly over toes and feet shoulder width apart for balance. Land lightly.</p>
↓ challenge	Remove the jump.
↑ challenge	Increase the height of your jump.

STATION 6: SWIMMER



Keep your core tight to protect your back.

STATION 7: REACHING LUNGES

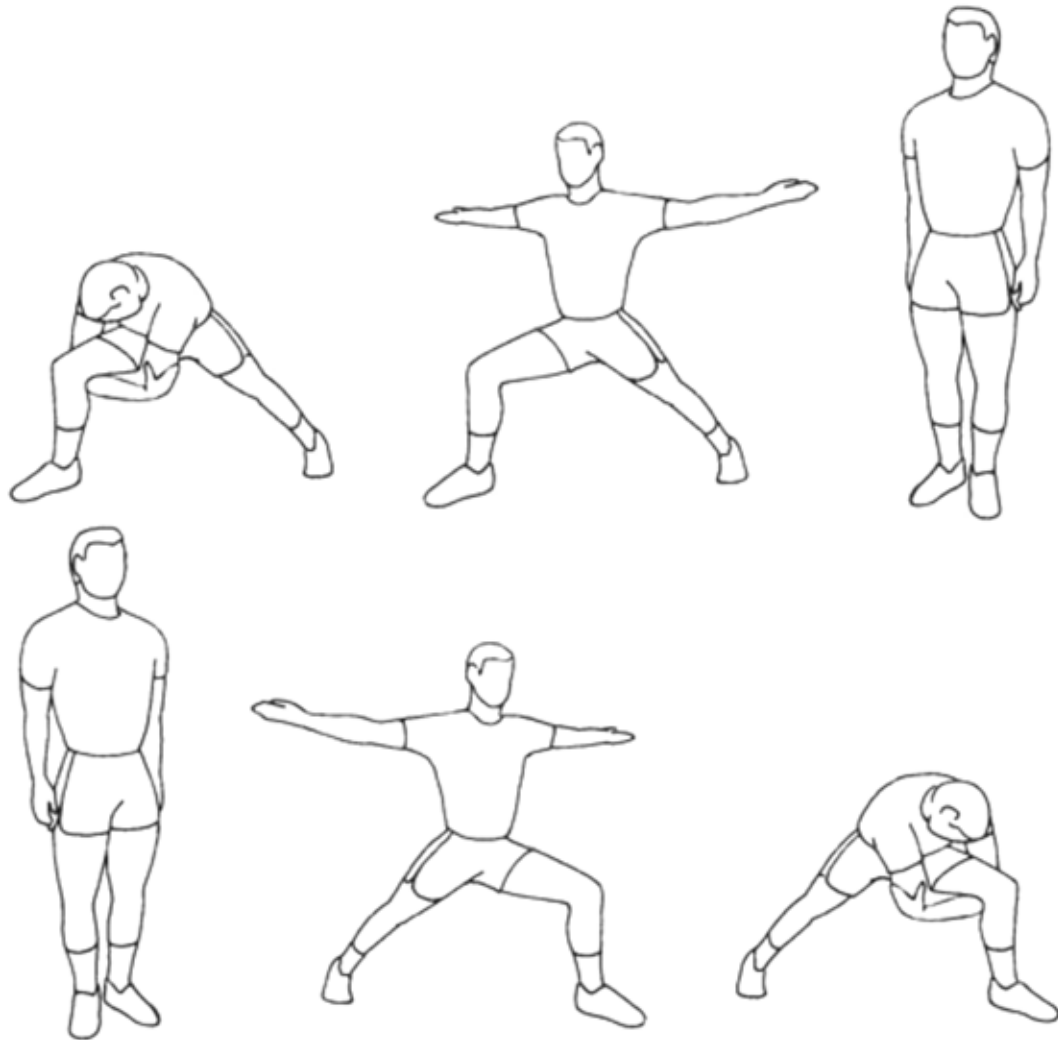

	Keep your posture straight to protect your back.
↓ challenge	Remove reach movement.
↑ challenge	Replace with alternating jump lunges.

STATION 8: CROSS COUNTRY SKIER

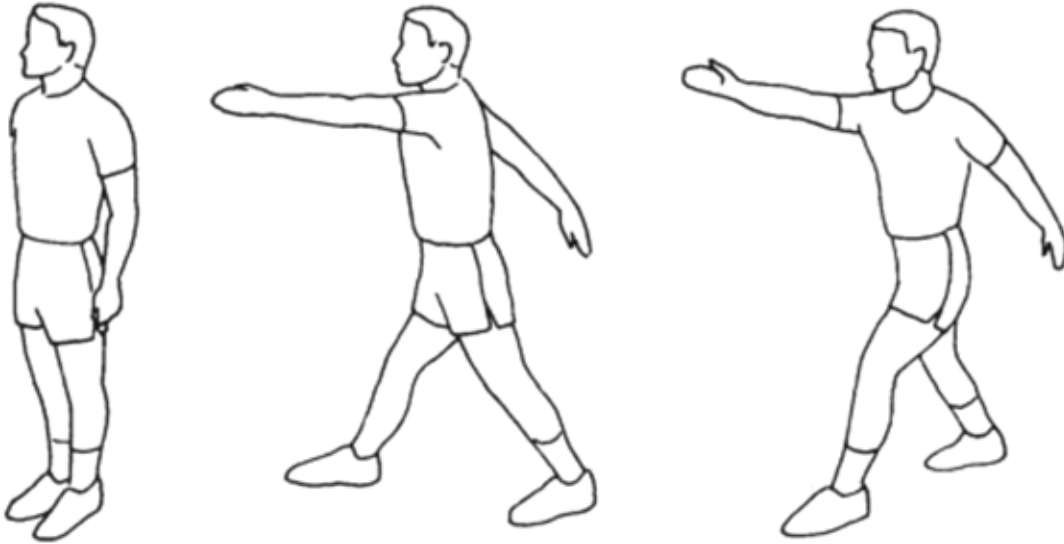

	Land lightly between jumps.
↓ challenge	Step instead of jumping in between positions.

STATION 9: BURPEES



	Keep core tight in plank position to protect your back.
↓ challenge	Stand up instead of jumping. Walk your feet to and from the plank position.
↑ challenge	Add a push-up from the plank position.

STATION 10: SEATED TWISTS

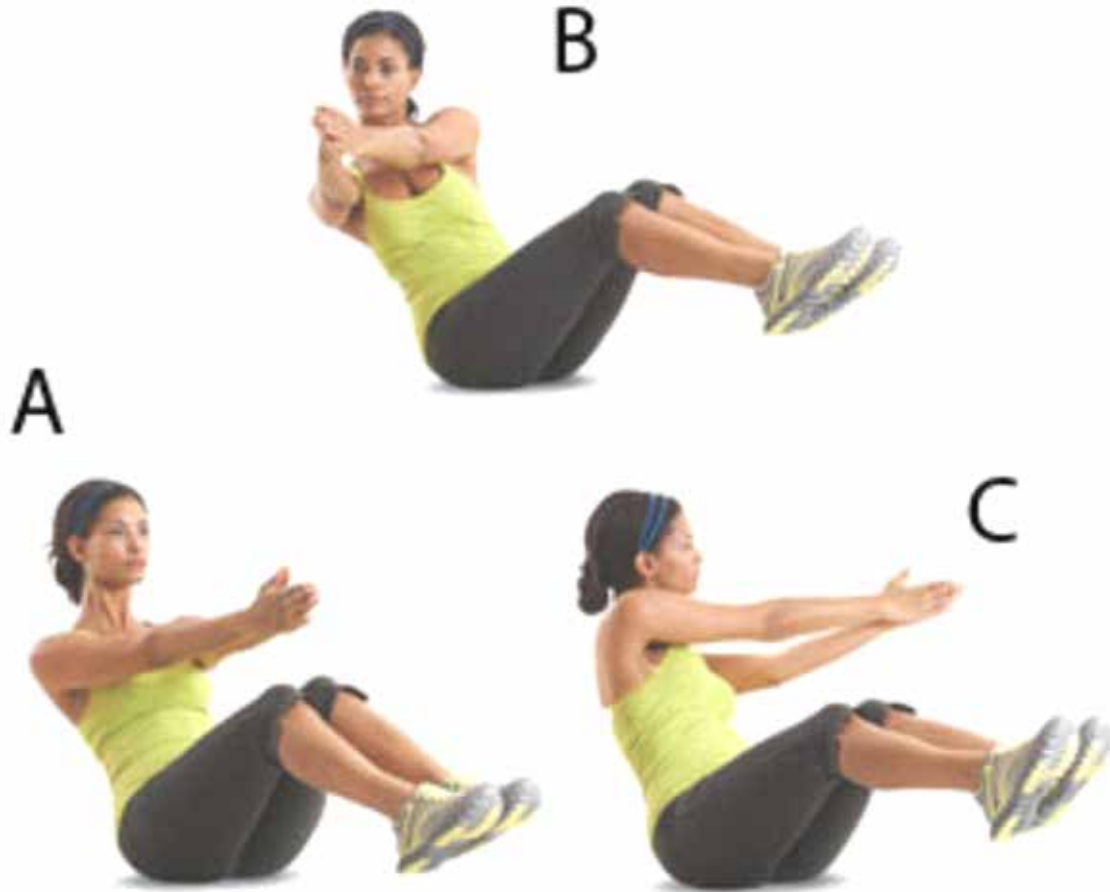

	Keep shoulders and posture straight to protect your back.
↓ challenge	Place feet on the floor for balance.
↑ challenge	Straighten arms and legs.

STATION 11: MOUNTAIN CLIMBER



Keep head up for safety.

↓ challenge

Step movements instead of jumping. Lower tempo.

STATION 12: ALTERNATING TS



	Keep core tight to protect your back.
↓ challenge	Balance on bent forearm and one knee.
↑ challenge	Lift top leg up and hold.

STATION 13: SPIDERMAN PUSH-UPS



	Keep straight line from head to knees.
↓ challenge	Regular push-ups.

STATION 14: LATERAL JUMPS



	Land lightly.
↓ challenge	Step instead of jumping.

STATION 15: FRONT KICK LUNGES



	Keep knees slightly bent while kicking.
↓ challenge	Touch knee instead of toes.

STATION 16: ALTERNATING CANOE STROKES



Keep core tight to protect your back.

STATION 17: JUMPING HIGH KNEES



Keep posture straight to protect your back.

STATION 18: OVER THE TOP



	Keep shoulders square, and back straight.
↑ challenge	Lift foot high off the floor with straightened leg.

STATION 19: SQUAT JUMPS



	Keep back straight. Land lightly.
↓ challenge	Remove the jump.

STATION 20: DONKEY KICKS



Keep core tight.

STATION 21: ALTERNATING JUMP LUNGES



	Keep back straight.
↓ challenge	Step instead of jumping.

STATION 22: FLUTTER KICK

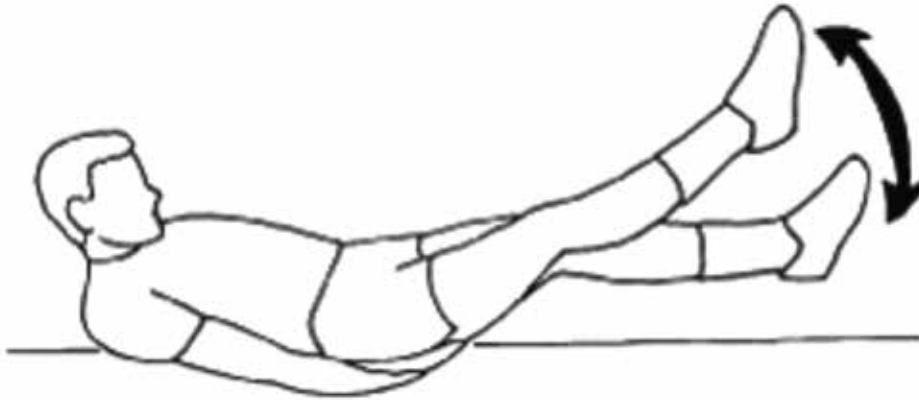

Keep lower back on the floor.

STATION 23: HIGH KNEE BRIDGE



	Keep head and shoulders against the floor.
↓ challenge	Remain in bridge position.

STATION 24: ALTERNATING BRIDGE



	Keep straight line from head to knees.
↓ challenge	Place knees on the floor. Continue the exercise.

STATION 25: WINDMILL JUMPING LUNGES



	Land lightly. Keep front knee behind the toes.
↓ challenge	Hands to knee.

STATION 26: HIGH KNEE SMASH



Keep your back straight.

↓ challenge

Hand to knee instead.

STATION 27: ALTERNATING LEG REACH



Keep back straight and hips square.
Keep supporting knee slightly bent.

STATION 28: LEG SWOOP



Control your movement at all times.

STATION 29: SKATER'S CRUNCH



	Keep core tight.
↓ challenge	Step instead of jumping.

STATION 30: SLALOM JUMPS

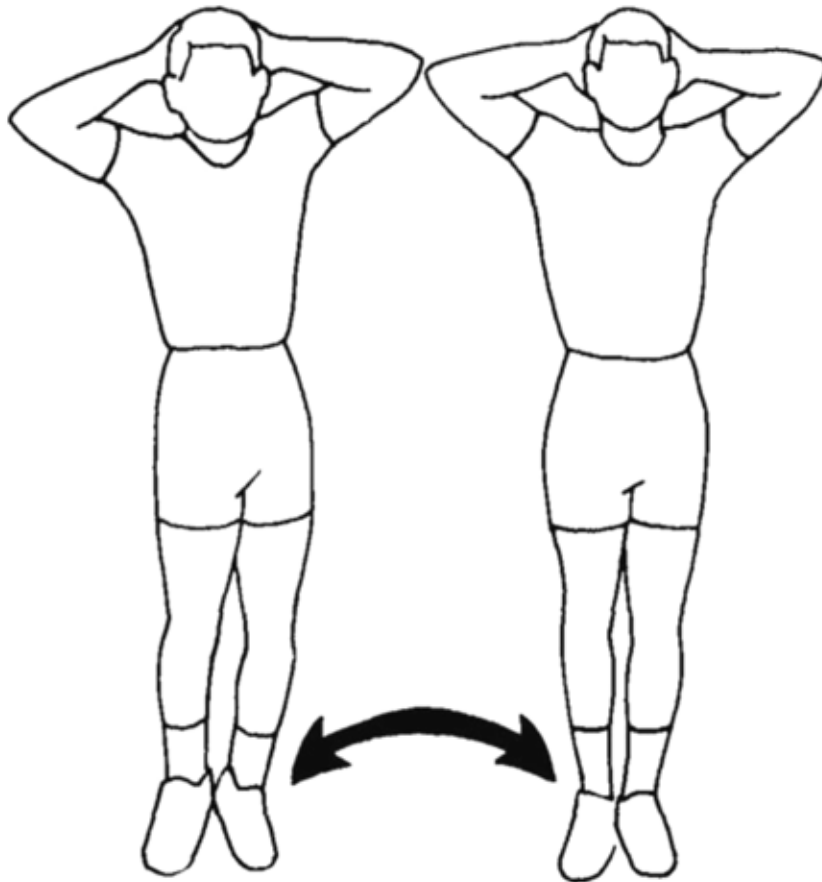

	<p>Keep your back straight. Land lightly.</p>
<hr style="border: 2px solid black;"/>	
↓ challenge	Step between movements instead of jumping.
↑ challenge	Increase the tempo.

Stations	Instructions
Station 1: Bicycle Legs	Lie on your back. Lift your legs off the floor and put your hands on your head. Alternate bringing your left knee to your right elbow, and your right knee to your left elbow.
Station 2: Push-ups	As per CATO 14-18, Cadet Fitness Assessment and Incentive Program.
Station 3: Star Jumps	Stand with your feet together and your arms by your side. In one motion, jump up while attempting to touch your hands above your head and splitting your legs apart, and then bring your body back to the original position before landing on the ground.
Station 4: Curl-ups	As per CATO 14-18, Cadet Fitness Assessment and Incentive Program, or with your hands on your knees.
Station 5: Frog Jumps	Feet shoulder-width apart, squat as low as you feel comfortable. (This may mean as far as having your buttocks close to the ground.) While in the squat position, touch the ground with your fingers. Then, explode upwards and reach your hands into the air. Land lightly and repeat.
Station 6: Swimmer	Lie on your stomach. Lift straight arms and legs in the air and alternate lifting left arm / right leg, and right arm / left leg. Keep your head close to the ground during the exercise.
Station 7: Reaching lunges	From the standing position, lunge to the right with your right leg, with your arms out straight at shoulder level, and your back straight. Ensure your right knee remains behind your toes as you get into position. Then, grab your right thigh with your arms. Release, and come back to the initial position. Repeat on the left side. Alternate between both sides.
Station 8: Cross country skier	Jump up so that your left foot and right arm are in front of your body. Switch your feet and arms. Repeat. Land lightly between jumps.
Station 9: Burpees	From the standing position, kneel and put your hands on the ground. Explode into the push-up position. Explode back into the kneeling position. Jump up in the air, with your arms up. Repeat.
Station 10: Seated Twists	Sit on the ground, and get into a V position. Lift your feet off the floor and then extend your arms in front of you, so that they are at a 90 degree angle with your body. Keeping your arms straight, alternate pointing your hands to the left and to the right. The speed of the movement should be slow and controlled. Keep your core tight.
Station 11: Mountain Climber	Get into a push-up position. Bring the left foot up, so your left knee is by your chest. In one movement, bring your left foot to the back while moving your right foot to the front. Keep alternating between movements. Keep your back straight and your buttocks down.
Station 12: Alternating Ts	Balance your body with your right arm and the outside of your right foot. Lift your right arm straight into the air. Then, smoothly move into a plank position, and keep turning until you balance on the left arm and the outside of the left foot. Repeat from one side to the other.
Station 13: Spiderman push-ups	Get into a push-up position. As you are going down into the push-up, bring one leg up, on the outside, so that the knee of that leg lifts up towards the elbow. On the way up, bring the leg back into place. Alternate between legs.

Stations	Instructions
Station 14: Lateral jumps	Stand on one leg, with the knee slightly bent. Using your arms for momentum, jump in the air, and land on the other leg. Repeat from side to side.
Station 15: Front kick lunges	Move your right foot back, to get into a lunge position. Ensure that the knee that is in front stays behind your toes. Touch your right fingers on the floor by your front toes. When you get up, kick forward with the foot that was behind. Keep kicking with the same foot for half of the time. Then repeat with the other leg for the remainder of the time.
Station 16: Alternating Canoe Strokes	Stand with your legs slightly wider than your shoulders, feet pointing towards the outside. Put your hands together, and in a smooth motion, move them from left to right, as if you were canoeing. The speed of the movement should be slow and controlled. Specific attention should be placed on keeping the core tight.
Station 17: Jumping High Knees	With your arms up, fists in front of your shoulders, run on the spot, while bringing your knees up. Land lightly between movements.
Station 18: Over the Top	Stand with your legs wider than your shoulders, knees bent, and feet pointing towards the outside. Put your hands together by your hips. In a quick motion straighten your legs and extend your arms (still linked at the hands) above your head. Come back to the original position, and alternate with the other side.
Station 19: Squat Jumps	Feet shoulder-width apart, squat down. Ensure your knees remain behind your toes as you squat. From that position, jump up in the air. Land lightly and repeat.
Station 20: Donkey Kicks	Get into the table position, on your hands and knees. Lift one knee off the floor, and while keeping it bent at a 90-degree angle, lift it up so your thigh becomes in-line with your back, and then bring it back to the other knee. Don't let it rest on the floor. Keep kicking with the same leg for half of the time. Then repeat with the other leg for the remainder of the time.
Station 21: Alternating Jump Lunges	From the standing position, jump into the lunge position. Ensure that the knee that is in front stays behind your toes. Then jump into the lunge position with your opposite leg in front. Keep alternating.
Station 22: Flutter Kick	Lie on your back. Lift your shoulders off the floor and place your hands under your buttocks. Lift your legs 10 cm off the floor. Keeping your legs straight, alternate moving your feet up and down without touching the floor.
Station 23: High Knee Bridge	Lie on your back. Place your hands by your sides and bring your feet close to your buttocks, so you can lift the bottom of your body on your heels. Get into the bridge position (knees at a 90-degree angle), and from there, alternate lifting the left and the right knees.
Station 24: Alternating Bridge	Get into the plank position. Simultaneously, lift your right arm and your left leg. Get back into the original position, and then lift your left arm and your right leg. Keep alternating.
Station 25: Windmill Jumping Lunges	Take a side step on the right with the right leg and bend down to touch your right toes with your left hand. Jump up into the same position on the left side. Bend down to touch your left toes with your right hand. Repeat. Keep your back straight throughout the exercise.

Stations	Instructions
Station 26: High Knee Smash	Stand up with your right arm up. In a quick motion, bring your left knee up to meet with your right elbow. Bring the knee back down and repeat for half of the time. Then repeat with the other leg for the remainder of the time.
Station 27: Alternating Leg Reach	From the standing position, lean forward with your hands forward and lift one leg up. Get back into the original position and repeat with the other leg. The speed of the movement should be slow and controlled. Keep the core tight.
Station 28: Leg Swoop	From the push-up position, extend one leg to its opposite side. Get back into the original position. Repeat with the other leg. Keep alternating.
Station 29: Skater's Crunch	With your arms up, fists in front of your shoulders, put your weight on your left leg. Simultaneously, bring your right leg behind, extending past your body on the left side. Jump into the same position on the right side. Keep alternating.
Station 30: Slalom jumps	Stand up and put your hands behind your head. Keeping your feet together, jump from one side to the other.

THIS PAGE INTENTIONALLY LEFT BLANK

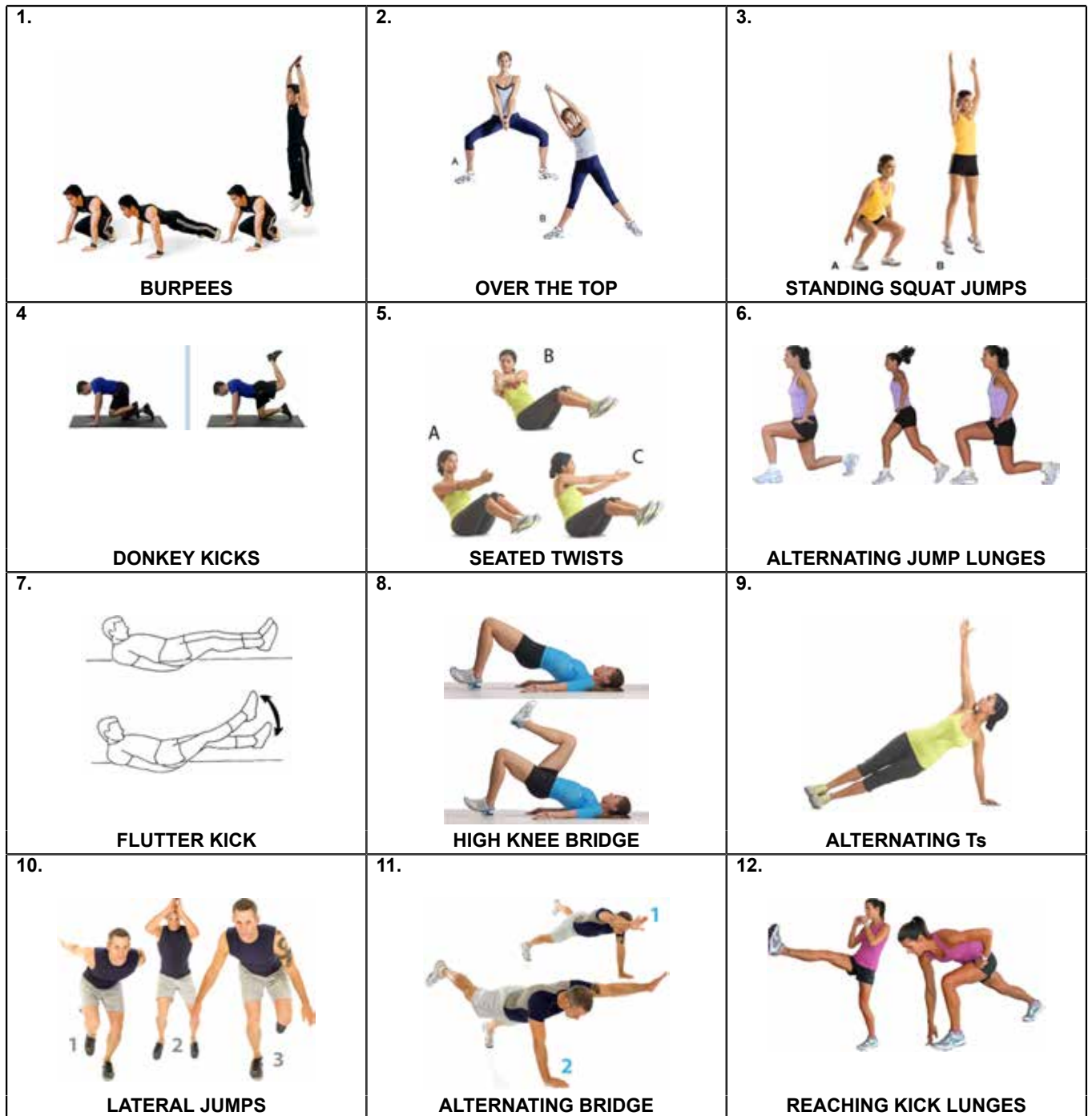

Figure C3-1 Instructor Guide, Option 1

<p>1.</p>  <p>MOUNTAIN CLIMBER</p>	<p>2.</p>  <p>BICYCLE LEGS</p>	<p>3.</p>  <p>SQUAT JUMPS</p>
<p>4.</p>  <p>WINDMILL JUMPING SIDE LUNGES</p>	<p>5.</p>  <p>STAR JUMPS</p>	<p>6.</p>  <p>HIGH KNEE SMASH</p>
<p>7.</p>  <p>ALTERNATING LEG REACH</p>	<p>8.</p>  <p>LEG SWOOP</p>	<p>9.</p>  <p>SPIDERMAN PUSH-UPS</p>
<p>10.</p>  <p>SKATER'S CRUNCH</p>	<p>11.</p>  <p>SLALOM JUMPS</p>	<p>12.</p>  <p>REACHING KICK LUNGES</p>

Figure C3-1 Instructor Guide, Option 2

LEARNING STATION 1: CANADIAN PHYSICAL ACTIVITY GUIDELINES AND CANADIAN SEDENTARY BEHAVIOUR GUIDELINES

OBJECTIVE: This activity is designed to raise awareness of the *Canadian Physical Activity Guidelines* and *Canadian Sedentary Behaviour Guidelines for Youth*, moderate-to-vigorous-intensity activities, and the three components of fitness.

TIME: 20 min

TRAINING LEVEL: 1

PRE-ACTIVITY INSTRUCTIONS:

- Assign an instructor to this activity.
- Gather the required resources:
 - *Canadian Physical Activity Guidelines for Youth* located at Appendix 1 (one copy per cadet), and
 - *Canadian Sedentary Behaviour Guidelines for Youth* located at Appendix 2 (one copy per cadet).
- Cut out the Three Components of Physical Fitness located at Appendix 3 and post on the wall.

ACTIVITY INSTRUCTIONS:

1. Distribute one copy of the *Canadian Physical Activity Guidelines for Youth* to each cadet.
2. Give the cadets three minutes to review the *Canadian Physical Activity Guidelines for Youth*. Ask cadets the following questions:
 - (a) How much moderate- to-vigorous-intensity physical activity should you do daily? (60 min)
 - (b) How often should you do vigorous-intensity activity per week? (3 times)
 - (c) How often in a week should you do activities that strengthen muscles and bones? (3 days per week)
 - (d) What activities can help strengthen muscles and bones? (Examples include planks, curl ups, sit ups, push ups, chin ups, lunges)
3. Explain the difference between moderate and vigorous intensity activity:
 - (a) Moderate-intensity activity will cause you to sweat a bit and breathe harder.
 - (b) Vigorous-intensity activity will cause you to sweat and be out of breath.
4. Point out the three cut-outs on the wall and ask the cadets to identify what they are. (They are the three components of physical fitness.) Explain that a balance of these is important to being physically fit.
5. Advise the cadets that they are now going to try three different activities so that they can feel the difference between moderate- and vigorous-intensity physical activity.
6. Tell the cadets that during the activity they should note when they are doing moderate-intensity activity and when it changes to vigorous-intensity activity. Tell the cadets the change in activity intensity will be different for each individual based on their current level of physical fitness.
7. Have the cadets participate in a six-minute period of activity (2 minutes of walking on the spot, 2 minutes of running on the spot, 2 minutes of jumping jacks).
8. Have the cadets reflect on the activity they have just completed. Suggested questions include:
 - (a) Could you tell when your activity intensity changed? How?
 - (b) Were you surprised at how soon the intensity changed?
 - (c) How often are you supposed to do vigorous-intensity activity?
9. Distribute a copy of the *Canadian Sedentary Behaviour Guidelines for Youth*.

10. Give the cadets three minutes to review the *Canadian Sedentary Behaviour Guidelines for Youth*. Ask the cadets the following questions:

- (a) What is sedentary behaviour? (A time when you are doing very little activity.)
- (b) What are the guidelines for youth for sedentary behaviour? (Minimize the time spent being sedentary each day. Limit recreational screen time to no more than 2 hours per day.)
- (c) What are some alternatives to sedentary behaviours? (Answers may vary. See table below.)

Some examples of alternatives to sedentary behaviour include:



- taking the stairs instead of taking the elevators;
- walking to someone's room and socializing instead of texting them;
- playing sports instead of watching them on television; or
- walking to school or riding a bicycle instead of taking the bus.

Canadian Physical Activity Guidelines

FOR YOUTH - 12 – 17 YEARS

Guidelines



For health benefits, youth aged 12-17 years should accumulate at least 60 minutes of moderate- to vigorous-intensity physical activity daily. This should include:



Vigorous-intensity activities at least 3 days per week.



Activities that strengthen muscle and bone at least 3 days per week.



More daily physical activity provides greater health benefits.

Let's Talk Intensity!

Moderate-intensity physical activities will cause teens to sweat a little and to breathe harder. Activities like:

- Skating
- Bike riding

Vigorous-intensity physical activities will cause teens to sweat and be 'out of breath'. Activities like:

- Running
- Rollerblading

Being active for at least 60 minutes daily can help teens:

- Improve their health
- Do better in school
- Improve their fitness
- Grow stronger
- Have fun playing with friends
- Feel happier
- Maintain a healthy body weight
- Improve their self-confidence
- Learn new skills

Parents and caregivers can help to plan their teen's daily activity. Teens can:

- Walk, bike, rollerblade or skateboard to school.
- Go to a gym on the weekend.
- Do a fitness class after school.
- Get the neighbours together for a game of pick-up basketball, or hockey after dinner.
- Play a sport such as basketball, hockey, soccer, martial arts, swimming, tennis, golf, skiing, snowboarding...

Now is the time. 60 minutes a day can make a difference.



www.csep.ca/guidelines

THIS PAGE INTENTIONALLY LEFT BLANK

Canadian Sedentary Behaviour Guidelines

FOR YOUTH - 12 – 17 YEARS

Guidelines

For health benefits, youth aged 12–17 years should minimize the time they spend being sedentary each day. This may be achieved by



Limiting recreational screen time to no more than 2 hours per day; lower levels are associated with additional health benefits.



Limiting sedentary (motorized) transport, extended sitting and time spent indoors throughout the day.

The lowdown on the slowdown: what counts as being sedentary?

Sedentary behaviour is time when teens are doing very little physical movement. Some examples are:

- Sitting for long periods
- Using motorized transportation (such as a bus or a car)
- Watching television
- Playing passive video games
- Playing on the computer

Spending less time being sedentary can help teens:

- Maintain a healthy body weight
- Improve their self-confidence
- Do better in school
- Improve their fitness
- Have more fun with their friends
- Have more time to learn new skills

Cutting down on sitting down. Help teens swap sedentary time with active time!



Now is the time for teens to get up and get moving!

THIS PAGE INTENTIONALLY LEFT BLANK

**CARDIOVASCULAR
ENDURANCE**

**MUSCULAR STRENGTH
& ENDURANCE**

FLEXIBILITY

THIS PAGE INTENTIONALLY LEFT BLANK

LEARNING STATION 2: NUTRITION JEOPARDY

OBJECTIVE: This activity is designed to raise awareness of proper portion amounts, daily recommended serving sizes, and how to use *Eating Well With Canada's Food Guide*.

TIME: 20 min

TRAINING LEVEL: 2

PRE-ACTIVITY INSTRUCTIONS:

- Assign an instructor to this activity.
- Create the Jeopardy Game Board, as shown in Appendix 1.
- Make copies of *Eating Well With Canada's Food Guide* (one per four cadets) located at Appendix 3.

ACTIVITY INSTRUCTIONS:

1. Divide the cadets into teams of four.
2. Distribute a copy of *Eating Well With Canada's Food Guide* to each team.
3. Explain to the cadets that:
 - (a) The objective of the game is to answer questions correctly and accumulate money.
 - (b) The team that provides the correct answer can select the next question; questions are for all teams to try to answer.
 - (c) *Eating Well With Canada's Food Guide* may be used to find answers.
 - (d) When a team believes they have a correct answer, a cadet from their team must stand up.
 - (e) The first cadet to stand will attempt to answer the question. A correct answer will earn that team the amount of money allocated to that question. For an incorrect answer, that amount will be withdrawn from that team's total.
4. Start the game by reading any of the \$10 questions.
5. When a correct answer is given, read the explanation on the bottom of the question.
6. When all questions on the board have been answered, determine a winning team.
7. As time allows, have the cadets discuss what they have learned through participating in this activity.

THIS PAGE INTENTIONALLY LEFT BLANK

JEOPARDY GAME BOARD

VEGETABLES AND FRUIT	GRAIN PRODUCTS	MILK AND ALTERNATIVES	MEAT AND ALTERNATIVES	VARIOUS
\$10	\$10	\$10	\$10	\$10
\$20	\$20	\$20	\$20	\$20
\$30	\$30	\$30	\$30	\$30
\$40	\$40	\$40	\$40	\$40
\$50	\$50	\$50	\$50	\$50

THIS PAGE INTENTIONALLY LEFT BLANK

Vegetables and Fruit

Q: How many daily servings of vegetables and fruit do teens 14–18 require?	\$10
A: They require 6–8 servings of vegetables and fruit.	
Explanation. Females require seven daily servings, while males require eight. Servings may be fresh, canned, frozen, dried, or even pureed.	
Q: How many millilitres are in one serving of fruit juice?	\$20
A: In one fruit juice serving, there are 125 ml. That is equivalent to ½ cup.	
Q: When eating canned vegetables, what is one portion?	\$30
A: One portion of canned vegetables is 125 ml. That is equivalent to ½ cup.	
Explanation. This amount also applies to fresh and frozen vegetables, cooked leafy vegetables, fresh, frozen, or canned fruits, as well as 100% juice.	
Q: What two colours of vegetables should you eat each day?	\$40
A: You should eat at least one dark green and one orange vegetable each day.	
Q: What methods of cooking vegetables are recommended instead of deep fried?	\$50
A: Enjoy vegetables steamed, baked or stir-fried instead of deep fried.	

Grain Products

Q: How many daily servings of grain products do teens 14–18 require?	\$10
A: They require 6–7 servings of grain products every day.	
Explanation. Females require six daily servings, while males require seven.	
Q: How many slices of bread make up one serving of grain products?	\$20
A: One slice of bread represents one serving of grain products.	
Q: What percentage of your daily grain intake should be from whole grain?	\$30
A: At least half of your grain products should be from whole grain each day.	
Q: One cup of brown rice represents how many portions of grain products?	\$40
A: One cup of rice is two portions of Grain Products.	
Q: How much pasta can you eat if you have to consume 3 portions of Grain Products?	\$50
A: You could consume 1 ½ cups of cooked pasta.	
Explanation. Each ½ cup of pasta is one portion of grain products. The same applies to couscous, cooked rice, bulgur and quinoa.	

Milk and Alternatives

Q: How many daily servings of milk and alternatives do teens 14–18 require?	\$10
A: They require 3–4 servings of milk and alternatives each day.	
Explanation. In this case, both females and males require the same amount daily.	
Q: How much milk can you drink to fulfill one serving of milk and alternatives?	\$20
A: One cup of milk (250 mL) is one portion of milk and alternatives.	
Q: What percentage of milk is recommended for consumption?	\$30
A: The recommendation is to drink skim, 1%, or 2% milk.	
Q: To get adequate vitamin D, how many cups of milk are recommended daily?	\$40
A: The recommendation is 500 mL (2 cups) of milk every day.	
Q: How much yogurt can be consumed for one serving of milk and alternatives?	\$50
A: One portion of yogurt is 175g. That is equivalent to $\frac{3}{4}$ cup.	

Meat and Alternatives

Q: How many daily servings of meat and alternatives do teens 14–18 require?	\$10
A: They require 2–3 servings of meat and alternatives each day.	
Explanation. Females require two daily servings, while males require three.	
Q: How many servings of fish are recommended each week?	\$20
A: At least 2 servings of fish are recommended every week.	
Q: How many eggs make up one serving of meat and alternatives?	\$30
A: Two eggs make one serving of meat and alternatives.	
Q: What cooking methods are recommended for meat and alternatives?	\$40
A: The recommendation is to use cooking methods such as roasting, baking or poaching that require little or no added fat.	
Q: What are some examples of legumes?	\$50
A: Beans and lentils are examples of legumes.	

Miscellaneous

Q: What vegetable oils are recommended for use?	\$10
A: Vegetable oils, such as canola, olive, and soybean are recommended.	
Q: What tool can be used to help compare food products?	\$20
A: The Nutrition Facts table can be used to make wiser choices.	
Explanation. For example, when selecting cheese or yogurts, the Nutrition facts table can help select a lower fat product.	
Q: What should be done with the skin on poultry?	\$30
A: Skin on poultry should be removed. Visible fat from meat should also be trimmed.	
Q: What Food Group would you benefit from having at each meal and snacks?	\$40
A: You would benefit from eating vegetables and fruit at all meals and as snacks.	
Q: What are the benefits of following <i>Canada's Food Guide</i>?	\$50
A: Meeting your needs in vitamins, minerals, and other nutrients; reducing the risk of obesity, type 2 diabetes, heart disease, certain types of cancer and osteoporosis; and contributing to your overall health and vitality.	

THIS PAGE INTENTIONALLY LEFT BLANK



Health Canada Santé Canada

Your health and safety... our priority.

Votre santé et votre sécurité... notre priorité.

Eating Well with Canada's Food Guide

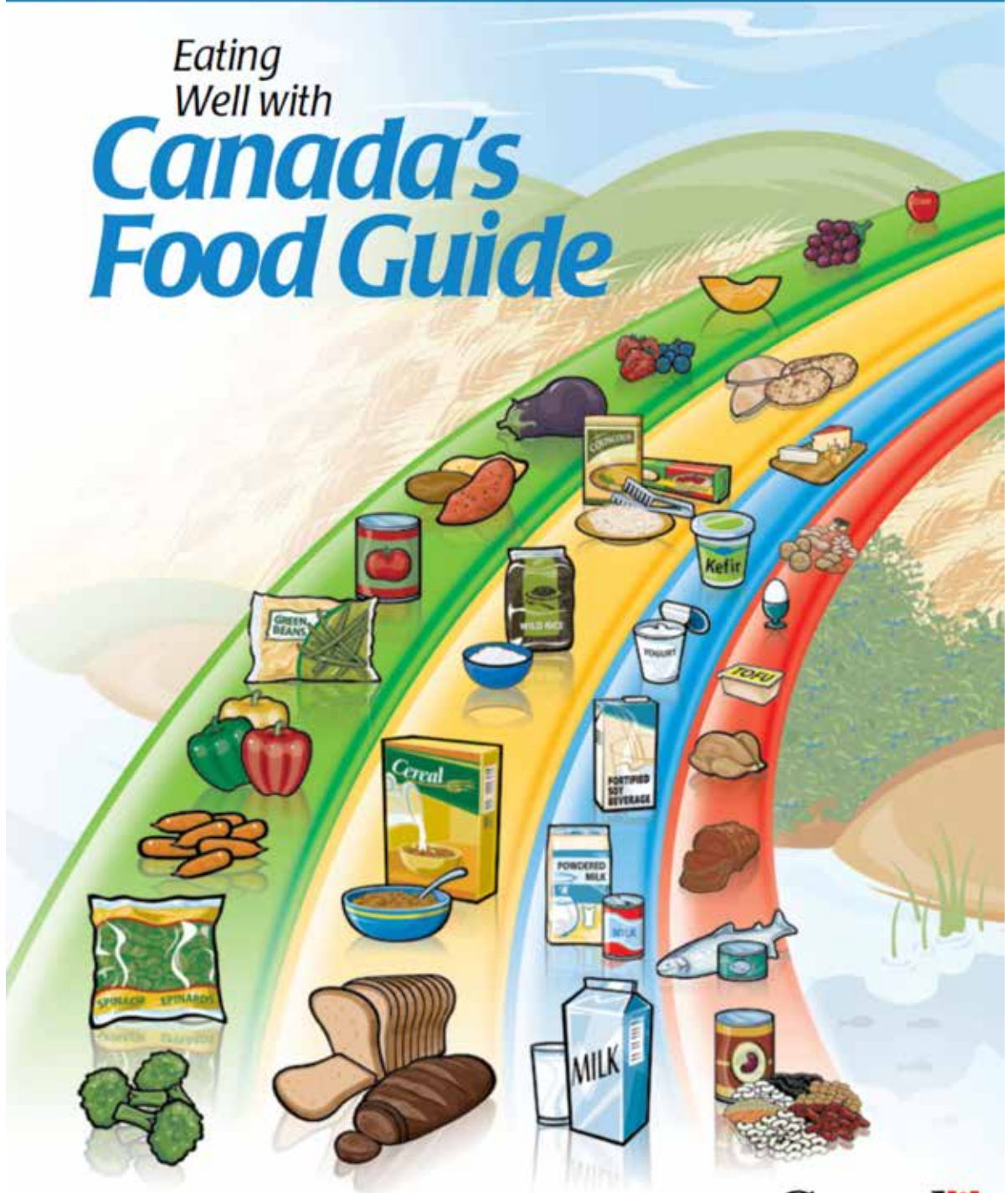

Canada 

Recommended Number of Food Guide Servings per Day

Age in Years Sex	Children			Teens		Adults			
	2-3	4-8	9-13	14-18		19-50		51+	
	Girls and Boys			Females	Males	Females	Males	Females	Males
Vegetables and Fruit	4	5	6	7	8	7-8	8-10	7	7
Grain Products	3	4	6	6	7	6-7	8	6	7
Milk and Alternatives	2	2	3-4	3-4	3-4	2	2	3	3
Meat and Alternatives	1	1	1-2	2	3	2	3	2	3

The chart above shows how many Food Guide Servings you need from each of the four food groups every day.

Having the amount and type of food recommended and following the tips in *Canada's Food Guide* will help:

- Meet your needs for vitamins, minerals and other nutrients.
- Reduce your risk of obesity, type 2 diabetes, heart disease, certain types of cancer and osteoporosis.
- Contribute to your overall health and vitality.

What is One Food Guide Serving?

Look at the examples below.

 <p>Fresh, frozen or canned vegetables 125 mL (½ cup)</p>		 <p>Leafy vegetables Cooked: 125 mL (½ cup) Raw: 250 mL (1 cup)</p>		 <p>Fresh, frozen or canned fruits 1 fruit or 125 mL (½ cup)</p>		 <p>100% Juice 125 mL (½ cup)</p>					
 <p>Bread 1 slice (35g)</p>		 <p>Bagel ½ bagel (45 g)</p>		 <p>Flat breads ½ pita or ½ tortilla (35 g)</p>		 <p>Cooked rice, bulgur or quinoa 125 mL (½ cup)</p>		 <p>Cereal Cold: 30 g Hot: 175 mL (¾ cup)</p>		 <p>Cooked pasta or couscous 125 mL (½ cup)</p>	
 <p>Milk or powdered milk (reconstituted) 250 mL (1 cup)</p>		 <p>Canned milk (evaporated) 125 mL (½ cup)</p>		 <p>Fortified soy beverage 250 mL (1 cup)</p>		 <p>Yogurt 175 g (¾ cup)</p>		 <p>Kefir 175 g (¾ cup)</p>		 <p>Cheese 50 g (1 ½ oz.)</p>	
 <p>Cooked fish, shellfish, poultry, lean meat 75 g (2 ½ oz.)/125 mL (½ cup)</p>		 <p>Cooked legumes 175 mL (¾ cup)</p>		 <p>Tofu 150 g or 175 mL (¾ cup)</p>		 <p>Eggs 2 eggs</p>		 <p>Peanut or nut butters 30 mL (2 Tbsp)</p>		 <p>Shelled nuts and seeds 60 mL (¾ cup)</p>	



Oils and Fats

- Include a small amount – 30 to 45 mL (2 to 3 Tbsp) – of unsaturated fat each day. This includes oil used for cooking, salad dressings, margarine and mayonnaise.
- Use vegetable oils such as canola, olive and soybean.
- Choose soft margarines that are low in saturated and trans fats.
- Limit butter, hard margarine, lard and shortening.



Make each Food Guide Serving count...
wherever you are – at home, at school, at work or when eating out!

- ▶ **Eat at least one dark green and one orange vegetable each day.**
 - Go for dark green vegetables such as broccoli, romaine lettuce and spinach.
 - Go for orange vegetables such as carrots, sweet potatoes and winter squash.
- ▶ **Choose vegetables and fruit prepared with little or no added fat, sugar or salt.**
 - Enjoy vegetables steamed, baked or stir-fried instead of deep-fried.
- ▶ **Have vegetables and fruit more often than juice.**

- ▶ **Make at least half of your grain products whole grain each day.**
 - Eat a variety of whole grains such as barley, brown rice, oats, quinoa and wild rice.
 - Enjoy whole grain breads, oatmeal or whole wheat pasta.
- ▶ **Choose grain products that are lower in fat, sugar or salt.**
 - Compare the Nutrition Facts table on labels to make wise choices.
 - Enjoy the true taste of grain products. When adding sauces or spreads, use small amounts.



- ▶ **Drink skim, 1%, or 2% milk each day.**
 - Have 500 mL (2 cups) of milk every day for adequate vitamin D.
 - Drink fortified soy beverages if you do not drink milk.
- ▶ **Select lower fat milk alternatives.**
 - Compare the Nutrition Facts table on yogurts or cheeses to make wise choices.

- ▶ **Have meat alternatives such as beans, lentils and tofu often.**
- ▶ **Eat at least two Food Guide Servings of fish each week.***
 - Choose fish such as char, herring, mackerel, salmon, sardines and trout.
- ▶ **Select lean meat and alternatives prepared with little or no added fat or salt.**
 - Trim the visible fat from meats. Remove the skin on poultry.
 - Use cooking methods such as roasting, baking or poaching that require little or no added fat.
 - If you eat luncheon meats, sausages or prepackaged meats, choose those lower in salt (sodium) and fat.



* Health Canada provides advice for limiting exposure to mercury from certain types of fish. Refer to www.healthcanada.gc.ca for the latest information.

Advice for different ages and stages...

Children	Women of childbearing age	Men and women over 50
<p>Following <i>Canada's Food Guide</i> helps children grow and thrive.</p> <p>Young children have small appetites and need calories for growth and development.</p> <ul style="list-style-type: none"> • Serve small nutritious meals and snacks each day. • Do not restrict nutritious foods because of their fat content. Offer a variety of foods from the four food groups. • Most of all... be a good role model. 	<p>All women who could become pregnant and those who are pregnant or breastfeeding need a multivitamin containing follic acid every day. Pregnant women need to ensure that their multivitamin also contains iron. A health care professional can help you find the multivitamin that's right for you.</p> <p>Pregnant and breastfeeding women need more calories. Include an extra 2 to 3 Food Guide Servings each day.</p> <p>Here are two examples:</p> <ul style="list-style-type: none"> • Have fruit and yogurt for a snack, or • Have an extra slice of toast at breakfast and an extra glass of milk at supper. 	<p>The need for vitamin D increases after the age of 50.</p> <p>In addition to following <i>Canada's Food Guide</i>, everyone over the age of 50 should take a daily vitamin D supplement of 10 µg (400 IU).</p> 

How do I count Food Guide Servings in a meal?



Here is an example:

Vegetable and beef stir-fry with rice, a glass of milk and an apple for dessert

250 mL (1 cup) mixed broccoli, carrot and sweet red pepper	=	2 Vegetables and Fruit Food Guide Servings
75 g (2 1/2 oz.) lean beef	=	1 Meat and Alternatives Food Guide Serving
250 mL (1 cup) brown rice	=	2 Grain Products Food Guide Servings
5 mL (1 tsp) canola oil	=	part of your Oils and Fats intake for the day
250 mL (1 cup) 1% milk	=	1 Milk and Alternatives Food Guide Serving
1 apple	=	1 Vegetables and Fruit Food Guide Serving

Eat well and be active today and every day!

The benefits of eating well and being active include:

- Better overall health.
- Lower risk of disease.
- A healthy body weight.
- Feeling and looking better.
- More energy.
- Stronger muscles and bones.



Be active

To be active every day is a step towards better health and a healthy body weight.

It is recommended that adults accumulate at least 2 ½ hours of moderate to vigorous physical activity each week and that children and youth accumulate at least 60 minutes per day. You don't have to do it all at once. Choose a variety of activities spread throughout the week.

Start slowly and build up.



Eat well

Another important step towards better health and a healthy body weight is to follow *Canada's Food Guide* by:

- Eating the recommended amount and type of food each day.
- Limiting foods and beverages high in calories, fat, sugar or salt (sodium) such as cakes and pastries, chocolate and candies, cookies and granola bars, doughnuts and muffins, ice cream and frozen desserts, french fries, potato chips, nachos and other salty snacks, alcohol, fruit flavoured drinks, soft drinks, sports and energy drinks, and sweetened hot or cold drinks.

Read the label

- Compare the Nutrition Facts table on food labels to choose products that contain less fat, saturated fat, trans fat, sugar and sodium.
- Keep in mind that the calories and nutrients listed are for the amount of food found at the top of the Nutrition Facts table.

Nutrition Facts	
Per 0 mL (0 g)	
Amount	% Daily Value
Calories 0	
Fat 0 g	0 %
Saturated 0 g	0 %
+ Trans 0 g	
Cholesterol 0 mg	
Sodium 0 mg	0 %
Carbohydrate 0 g	0 %
Fibre 0 g	0 %
Sugars 0 g	
Protein 0 g	
Vitamin A 0 %	Vitamin C 0 %
Calcium 0 %	Iron 0 %

Limit trans fat

When a Nutrition Facts table is not available, ask for nutrition information to choose foods lower in trans and saturated fats.

Take a step today...

- ✓ Have breakfast every day. It may help control your hunger later in the day.
- ✓ Walk wherever you can – get off the bus early, use the stairs.
- ✓ Benefit from eating vegetables and fruit at all meals and as snacks.
- ✓ Spend less time being inactive such as watching TV or playing computer games.
- ✓ Request nutrition information about menu items when eating out to help you make healthier choices.
- ✓ Enjoy eating with family and friends!
- ✓ Take time to eat and savour every bite!



For more information, interactive tools, or additional copies visit *Canada's Food Guide on-line at:*
www.healthcanada.gc.ca/foodguide

or contact:

Publications
Health Canada
Ottawa, Ontario K1A 0K9
E-Mail: publications@hc-sc.gc.ca
Tel.: 1-866-225-0709
Fax: (613) 941-5366
TTY: 1-800-267-1245

Également disponible en français sous le titre :
Bien manger avec le Guide alimentaire canadien

This publication can be made available on request on diskette, large print, audio-cassette and braille.

LEARNING STATION 3: STRESS

OBJECTIVE: This activity is designed to raise awareness of stress, eustress and distress and to give cadets tools to deal with stress.

TIME: 20 min

TRAINING LEVEL: 3

PRE-ACTIVITY INSTRUCTIONS:

- Assign an instructor to this activity.
- Set up the four stations, one per relaxation exercise.
- Gather the required resources:
 - Chairs,
 - Flipchart paper,
 - Pens / pencils, and
 - Markers.

ACTIVITY INSTRUCTIONS:

1. Ask the cadets the following questions:
 - (a) What is stress? (Stress is the body's reaction to a demanding situation.)
 - (b) What is the difference between eustress and distress? (Eustress is described as good stress. This type of stress pushes a person to do better and reach goals. Distress is described as bad stress. This type of stress causes worry, sorrow, anger or pain.)
2. Divide the cadets into groups of three or four.
3. Distribute flipchart paper, pens / pencils and markers to each group.
4. Allow five minutes for cadets to brainstorm ways to overcome bad stress (distress).
5. Allow each group to share one item on their list and share why it is there.

Possible answers:

- | | |
|---------------------------------------|---|
| • going for a walk or a run; | • laughing; |
| • going to the gym / playing a sport; | • practicing yoga or meditations; |
| • listening to music; | • playing with a pet (dog, cat, etc.); |
| • talking to someone about the issue; | • using time wisely; and |
| • watching a movie; | • writing down your problem in a journal. |

6. Demonstrate the first relaxation exercise located at Appendix 1.
7. Allow two minutes for the cadets to perform the exercise.
8. Repeat the process with the other exercises.

THIS PAGE INTENTIONALLY LEFT BLANK

RAG DOLL

1. Sit in a chair (or stand) with feet apart.
2. Stretch the arms and trunk upward and inhale.
3. Exhale and drop the body forward. Let the trunk, head and arms dangle between the legs, keeping the muscles relaxed (as illustrated in Figure F1-1).
4. Remain in this position for 10–15 seconds.
5. Slowly roll up, one vertebrae at a time.



Figure F1-1 Rag Doll

NECK ROLL

1. Sit in a chair or on the floor with legs crossed.
2. Keeping the head and chin tucked, inhale and slowly turn the head as far left as possible (as illustrated in Figure F1-2).
3. Exhale and turn the head to the centre.
4. Repeat Steps 2 and 3 for the right side.
5. Repeat Steps 2–4 three times, trying to turn further each time to feel the stretch in the neck.
6. Drop the chin to the chest and inhale while slowly rolling the head in a semicircle to the left shoulder and exhale while slowly rolling the head back to the centre.
7. Repeat Step 6 for the right side.



Do not roll the head backward or in a full circle.



Figure F1-2 Neck Roll

BODY BOARD

1. Lie on the right side with arms over the head (as illustrated in Figure F1-3).
2. Inhale and stiffen the body like a wooden board.
3. Exhale and relax the muscles.
4. Let the body fall without trying to control the direction (as illustrated in Figure F1-4).
5. Lie still for ten seconds.
6. Repeat Steps 1–5 for the left side.

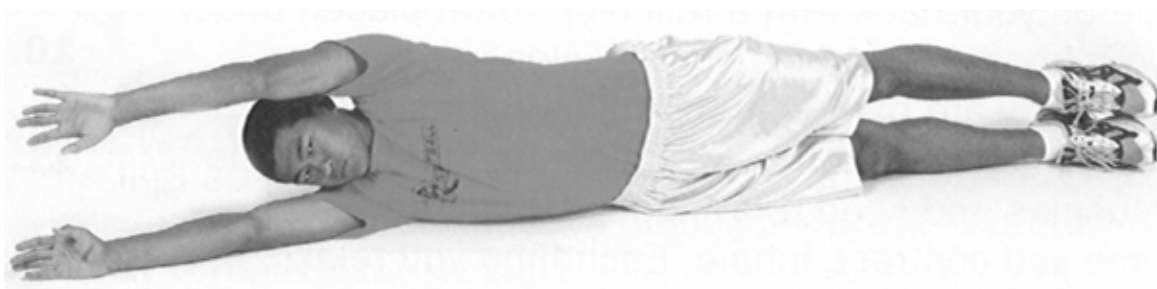

Figure F1-3 Body Board Start Position

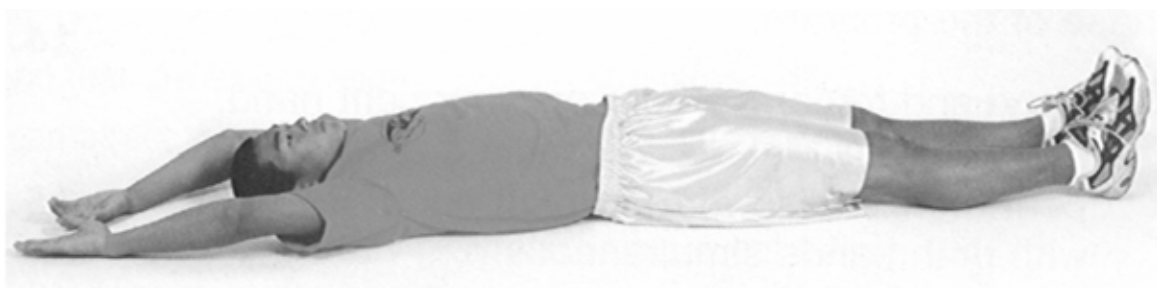

Figure F1-4 Body Board Finish Position

JAW STRETCH

1. Sit in a chair or on the floor with head up and arms and shoulders relaxed.
2. Open mouth as wide as possible and inhale.
3. Relax and exhale slowly.
4. Shift the jaw to the right as far as possible and hold for three seconds (as illustrated in Figure F1-5).
5. Repeat Step 4 for the left side.
6. Repeat Steps 4 and 5 ten times.

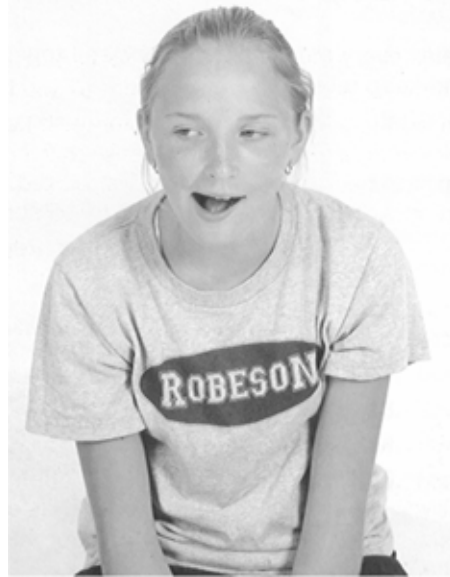

Figure F1-5 Jaw Stretch

LEARNING STATION 4: HEALTHY LIFESTYLE TOOL BELT

OBJECTIVE: This activity is designed to provide an awareness of activities that can be added to enhance healthy living.

TIME: 20 min

TRAINING LEVEL: 4

PRE-ACTIVITY INSTRUCTIONS:

- Assign an instructor to this activity.
- Gather required resources:
 - Healthy Lifestyle Tool Belt handout, located Appendix 1, for each cadet,
 - Mats, and
 - Pens / pencils.

ACTIVITY INSTRUCTIONS:

1. Distribute the Healthy Lifestyle Tool Belt handout to each cadet.
2. Explain that they will be completing five quick activities to develop an awareness of behaviours that can be used to promote a healthier lifestyle.
3. Ask for a volunteer to read the following information:

“The commitments we make to ourselves and to others, and our integrity to those commitments, is the essence and clearest manifestation of our proactivity.”

S. Covey, *The 7 Habits of Highly Effective People*.

Facts:

- Commitments are things we agree to do, whether for ourselves or for someone else.
- To develop integrity we have to stop making so many commitments and check to see, before taking on or making new commitments, if we will actually follow through, for sure.

4. Give the cadets one minute to identify their current commitments in Block 1 of the handout.
5. Have the cadets make a commitment to themselves related to healthy eating in Block 2 of the handout.
6. Ask for a volunteer to read the following information:

“Research unequivocally shows that simple meditation practices for as little as 12–15 minutes per day can have HUGE positive results for us. As we close our eyes, breathe deeply and allow our minds to chillax, we go from active thinking to mellow chill-axing while triggering what Herbert Benson (the preeminent Harvard/MD researcher) calls ‘The Relaxation Response’.”

B. Johnson, *A Philosopher’s Notes*

7. Have the cadets assume the Child's Pose– Balasana or Corpse Pose– Savasana. Allow the cadets to remain in the position for 2 minutes: tell the cadets to breathe calmly, let their bodies relax and their minds unclutter.



Figure J-1 Child's Pose – Balasana



Figure J-2 Corpse Pose – Savasana

8. Ask the cadets how they felt during the exercise.
9. Ask for a volunteer to read the following information:

Author Eckhart Tolle tells us that although it is “important that we accept ourselves and our emotions”, it's also really important to notice what thoughts and behaviours consistently lead to negative outcomes and to stop doing those things and thinking those thoughts.

E. Tolle, *The Power of Now*

10. Have the cadets identify behaviours that they have that consistently lead to negative outcomes in Block 5 of the handout. Examples: slamming the car door, having thoughts that you need to be the best at everything.
11. Have the cadets identify positive behaviours they would like to continue in Block 6 of the handout.
12. Ask for a volunteer to read the following information:

Robin Sharma is a Canadian author whose studies on greatness have found that “all great people have a passionate consistency for their fundamentals”—whether the specific manifestation of one's greatness is being an extraordinary athlete, political leader, entrepreneur, artist or musician. Every day, they attend to their fundamentals—it could be meditating, exercising every day, giving joy, appreciating someone, writing in a journal, practicing music, studying.

R. Sharma, *The Greatness Guide 2*

13. Tell the cadets that fundamentals are basic values or tasks that a person completes as part of their daily regimen and have them identify their current fundamentals in Block 7 of the handout.
14. Have the cadets circle the fundamentals they hope to continue for the rest of their life.



15. Ask for a volunteer to read the following information:

In the book *Spark*, author Dr. John Ratey demonstrates how and why physical activity is crucial to the way we think and feel. “A notable experiment in 2007 showed that cognitive flexibility improves after just one 35-minute treadmill session at either 60 percent or 70 percent of maximum heart rate. The 40 adults in the study (aged 50–64) were asked to rattle off alternative uses for common objects like a newspaper —it’s meant for reading, but it can be used to wrap fish, line a birdcage, pack dishes and so forth. Half of them watched a movie and the other half exercised, and they were tested before the session, immediately after and again 20 minutes later. The movie watchers showed no change, but the runners improved their processing speed and cognitive flexibility after just one workout. Cognitive flexibility is an important executive function that reflects our ability to shift thinking and to produce a steady flow of creative thoughts and answers as opposed to a regurgitation of the usual responses. So if you have an important afternoon brainstorming session scheduled, going for a short, intense run during lunchtime is a smart idea.”

J. Ratey, *Spark: The Revolutionary New Science of Exercise and the Brain*

16. Have the cadets identify activities they think they could be better prepared to perform if they did a short intense period of physical exercise prior to the activity in block 8 of the handout.

THIS PAGE INTENTIONALLY LEFT BLANK

HEALTHY LIFESTYLE TOOL BELT	
<p>1. My current commitments are:</p> <p><input type="checkbox"/> _____</p> <p><input type="checkbox"/> _____</p> <p><input type="checkbox"/> _____</p> <p><input type="checkbox"/> _____</p> <p><input type="checkbox"/> _____</p>	<p>2. My commitment to myself related to healthy eating:</p> <p><input type="checkbox"/> eat no chocolate bars at the cadet canteen</p> <p><input type="checkbox"/> drink water with each meal</p> <p><input type="checkbox"/> _____</p> <p><input type="checkbox"/> _____</p> <p><input type="checkbox"/> _____</p>
<p>3.</p> <div style="text-align: center;">  </div> <p style="text-align: center;">Figure J1-1 Child's Pose – Balasana</p>	<p>4.</p> <div style="text-align: center;">  </div> <p style="text-align: center;">Figure J1-2 Corpse Pose – Savasana</p>
<p>5. My current behaviours that lead to negative outcomes are:</p> <p><input type="checkbox"/> late for timings</p> <p><input type="checkbox"/> _____</p> <p><input type="checkbox"/> _____</p> <p><input type="checkbox"/> _____</p>	<p>6. Positive behaviours I want to continue:</p> <p>_____</p> <p>_____</p> <p>_____</p> <p>_____</p> <p>_____</p>
<p>7. My current fundamentals, the things I attend to every day, are:</p> <p><input type="checkbox"/> meditate for ____minutes</p> <p><input type="checkbox"/> offer thanks to another person</p> <p><input type="checkbox"/> offer praise to another person</p> <p><input type="checkbox"/> exercise ____minutes</p> <p><input type="checkbox"/> write in a journal</p> <p><input type="checkbox"/> _____</p> <p><input type="checkbox"/> _____</p> <p><input type="checkbox"/> _____</p>	<p>8. My brain will be better prepared to perform if I engage in short periods of intense physical exercise before the following activities:</p> <p><input type="checkbox"/> studying</p> <p><input type="checkbox"/> writing an exam</p> <p><input type="checkbox"/> attending a meeting</p> <p><input type="checkbox"/> giving a speech</p> <p><input type="checkbox"/> _____</p> <p><input type="checkbox"/> _____</p> <p><input type="checkbox"/> _____</p>
<p>“You must be the change you want to see in the world” - Mahatma Ghandi</p>	

THIS PAGE INTENTIONALLY LEFT BLANK



PHYSICAL ACTIVITY TRACKER



	Monday	Tuesday	Wednesday	Thursday	Friday	Saturday	Sunday
Week 1	Physical Activity Time 15 30 45 60 75 90	Physical Activity Time 15 30 45 60 75 90	Physical Activity Time 15 30 45 60 75 90	Physical Activity Time 15 30 45 60 75 90	Physical Activity Time 15 30 45 60 75 90	Physical Activity Time 15 30 45 60 75 90	Physical Activity Time 15 30 45 60 75 90
	Physical Activity List	Physical Activity List	Physical Activity List	Physical Activity List	Physical Activity List	Physical Activity List	Physical Activity List
	Less than 2 hours of recreational screen time 😊 ☹️	Less than 2 hours of recreational screen time 😊 ☹️	Less than 2 hours of recreational screen time 😊 ☹️	Less than 2 hours of recreational screen time 😊 ☹️	Less than 2 hours of recreational screen time 😊 ☹️	Less than 2 hours of recreational screen time 😊 ☹️	Less than 2 hours of recreational screen time 😊 ☹️
Week 2	Physical Activity Time 15 30 45 60 75 90	Physical Activity Time 15 30 45 60 75 90	Physical Activity Time 15 30 45 60 75 90	Physical Activity Time 15 30 45 60 75 90	Physical Activity Time 15 30 45 60 75 90	Physical Activity Time 15 30 45 60 75 90	Physical Activity Time 15 30 45 60 75 90
	Physical Activity List	Physical Activity List	Physical Activity List	Physical Activity List	Physical Activity List	Physical Activity List	Physical Activity List
	Less than 2 hours of recreational screen time 😊 ☹️	Less than 2 hours of recreational screen time 😊 ☹️	Less than 2 hours of recreational screen time 😊 ☹️	Less than 2 hours of recreational screen time 😊 ☹️	Less than 2 hours of recreational screen time 😊 ☹️	Less than 2 hours of recreational screen time 😊 ☹️	Less than 2 hours of recreational screen time 😊 ☹️
Cadet's Signature: _____ Date: _____ Supervisor's Signature: _____ Date: _____							



PHYSICAL ACTIVITY TRACKER



	Monday	Tuesday	Wednesday	Thursday	Friday	Saturday	Sunday
Week 3	Physical Activity Time 15 30 45 60 75 90	Physical Activity Time 15 30 45 60 75 90	Physical Activity Time 15 30 45 60 75 90	Physical Activity Time 15 30 45 60 75 90	Physical Activity Time 15 30 45 60 75 90	Physical Activity Time 15 30 45 60 75 90	Physical Activity Time 15 30 45 60 75 90
	Physical Activity List	Physical Activity List	Physical Activity List	Physical Activity List	Physical Activity List	Physical Activity List	Physical Activity List
	Less than 2 hours of recreational screen time 😊 ☹️	Less than 2 hours of recreational screen time 😊 ☹️	Less than 2 hours of recreational screen time 😊 ☹️	Less than 2 hours of recreational screen time 😊 ☹️	Less than 2 hours of recreational screen time 😊 ☹️	Less than 2 hours of recreational screen time 😊 ☹️	Less than 2 hours of recreational screen time 😊 ☹️
Week 4	Physical Activity Time 15 30 45 60 75 90	Physical Activity Time 15 30 45 60 75 90	Physical Activity Time 15 30 45 60 75 90	Physical Activity Time 15 30 45 60 75 90	Physical Activity Time 15 30 45 60 75 90	Physical Activity Time 15 30 45 60 75 90	Physical Activity Time 15 30 45 60 75 90
	Physical Activity List	Physical Activity List	Physical Activity List	Physical Activity List	Physical Activity List	Physical Activity List	Physical Activity List
	Less than 2 hours of recreational screen time 😊 ☹️	Less than 2 hours of recreational screen time 😊 ☹️	Less than 2 hours of recreational screen time 😊 ☹️	Less than 2 hours of recreational screen time 😊 ☹️	Less than 2 hours of recreational screen time 😊 ☹️	Less than 2 hours of recreational screen time 😊 ☹️	Less than 2 hours of recreational screen time 😊 ☹️
Cadet's Signature: _____		Date: _____		Supervisor's Signature: _____		Date: _____	



COMMON TRAINING
ALL TRAINING LEVELS
INSTRUCTIONAL GUIDE
PERSONAL FITNESS
AND HEALTHY LIVING



SECTION 2

**EO MX04.02 – IDENTIFY STRATEGIES TO IMPROVE PARTICIPATION IN
 PHYSICAL ACTIVITIES AND PARTICIPATE IN THE CADET FITNESS ASSESSMENT**

Total Time:

One session (3 periods) = 90 min

PREPARATION

PRE-LESSON INSTRUCTIONS

This IG supports EO MX04.02 (Identify Strategies to Improve Participation in Physical Activities and Participate in the Cadet Fitness Assessment) located in A-CR-CCP-701/PG-001, *Royal Canadian Army Cadets Green Star Qualification Standard and Plan*, Chapter 4.

Review CATO 14-18, *Cadet Fitness Assessment and Incentive Program* and become familiar with the material prior to delivering the lesson.

Photocopy the *Individual Score Sheet for the 20-m Shuttle Run Test* located at CATO 14-18, Annex A, Appendix 1 for each cadet.

Photocopy the *Cadet Fitness Assessment and Incentive Level Results* located at CATO 14-18, Annex B, Appendix 3 for each cadet.

Photocopy Introduction to Goal Setting located at Annex A for one assistant instructor and Review of Goal Setting located at Annex A for the other.

Photocopy the SMART Goals Guide located at Annex A, Appendix 1 for each cadet.

Refer to the warm-up and the cool-down located at Annexes A and B of EO MX04.01 (Participate in 60 Minutes of Moderate- to Vigorous-Intensity Physical Activity and Track Participation in Physical Activities) for TP 3.

Assistant instructors are required for this lesson.

PRE-LESSON ASSIGNMENT

Nil.

APPROACH

An in-class activity was chosen for TP 1 as it is a fun and interactive way for cadets to compare their physical activity to the *Canadian Physical Activity Guidelines for Youth* and the *Canadian Sedentary Behaviour Guidelines for Youth*.

A practical activity was chosen for TPs 2 and 3 as it is a fun and interactive way to build on the cadets' knowledge of personal fitness and healthy living.

INTRODUCTION

REVIEW

Nil.

OBJECTIVES

By the end of this lesson the cadet shall have compared their participation in physical activity to the *Canadian Physical Activity Guidelines for Youth* and *Canadian Sedentary Behaviour Guidelines for Youth*, have participated in the CFA, and set goals to improve their participation in physical activity.

IMPORTANCE

Meeting the *Canadian Physical Activity Guidelines for Youth* and *Canadian Sedentary Behaviour Guidelines for Youth* allows individuals to lead more active, healthy lives. Participating in the CFA will give cadets a tool to evaluate their physical fitness, which will allow them to set personal goals for improvement. Setting SMART goals is another great tool that cadets can use to maintain a healthier lifestyle.

Teaching Point 1

Conduct an activity where cadets compare their participation in physical activities to the *Canadian Physical Activity Guidelines for Youth* and the *Canadian Sedentary Behaviour Guidelines for Youth*.

Time: 15 min

Method: In-Class Activity

ACTIVITY

OBJECTIVE

The objective of this activity is to have the cadets compare their participation in physical activities to the *Canadian Physical Activity Guidelines for Youth* and *Canadian Sedentary Behaviour Guidelines for Youth*.

RESOURCES

- Completed Physical Activity Tracker,
- *Canadian Physical Activity Guidelines for Youth*, and
- *Canadian Sedentary Behaviour Guidelines for Youth*.

ACTIVITY LAYOUT

Nil.

ACTIVITY INSTRUCTIONS

1. Have the cadets think individually about the following questions:
 - (a) Did you meet the minimum requirements of the *Canadian Physical Activity Guidelines for Youth*? (60 minutes of activity daily)
 - (b) Did you meet the requirements of the *Canadian Sedentary Behaviour Guidelines for Youth*? (Limit recreational screen time to no more than 2 hours per day, and limit sedentary (motorized) transport, extended sitting time as well as time spent indoors throughout the day)
 - (c) What are some of your personal barriers to physical activity? How can you overcome these barriers? (See table below)
 - (d) What are some ways to improve your participation in physical activity? (See table below)

Possible barriers to being physically active	Strategies to overcome barriers
No time, energy or motivation. Programs, facilities, transportation are too expensive. No friend / family member to exercise with. The fitness facility isn't nearby or it's on a road that's too busy for safe walking or cycling. Not enough support from family / friends. No confidence or the right clothing. Bad weather. The fitness facility doesn't make me feel welcome or comfortable.	Schedule some time throughout your weekly schedule to commit to be fit! Ask a family member, friend, teacher, officer, or fellow cadet for help. Convince yourself that physical activity will increase your energy level. Make activities that you already do more active (eg, clean your room while listening to upbeat music). Set goals. Track your progress. Get more sleep. Do a self assessment.

2. Divide cadets into pairs and allow five minutes for cadets to discuss questions a–d above.
3. As a large group, allow five minutes for cadets to share what they have learned from their discussions. Emphasize strategies to overcome barriers to being physically active.

SAFETY

Nil.

Teaching Point 2

Have the cadets set a SMART goal to improve their participation in physical activities.

Time: 15 min

Method: Practical Activity

ACTIVITY

OBJECTIVE

The objective of this activity is to have the cadets set a SMART goal to improve their participation in physical activities.

RESOURCES

- SMART Goals Guide located at Appendix 1 for each cadet, and
- Pens / pencils.

ACTIVITY LAYOUT

Nil.

ACTIVITY INSTRUCTIONS

1. Divide cadets into two groups: Year 1, and Years 2–4.
2. Assign each group an assistant instructor.

3. Conduct the following activities as per Annex A:
 - (a) Introduction to Goal Setting for Year 1 cadets; and
 - (b) Review of Goal Setting for Years 2–4, as per Annex A.

SAFETY

Nil.

Teaching Point 3

Supervise while the cadets participate in the Cadet Fitness Assessment.

Time: 60 min

Method: Practical Activity

ACTIVITY



The Cadet Fitness Assessment shall be conducted IAW CATO 14-18, *Cadet Fitness Assessment and Incentive Program*.

OBJECTIVE

The objective of this activity is to have the cadets participate in the Cadet Fitness Assessment.

RESOURCES

- CATO 14-18, *Cadet Fitness Assessment and Incentive Program*,
- Leger 20-m Shuttle Run Test CD,
- Measuring tape,
- CD player,
- Pylons,
- Gym mats,
- 12-cm measuring strips,
- Stopwatches,
- Paper,
- Pens / pencils,
- Metre sticks,
- *Back-saver sit and reach* test apparatuses, and
- *Individual Score Sheet for the 20-m Shuttle Run Test*.

ACTIVITY LAYOUT

Set up the activity IAW CATO 14-18.

ACTIVITY INSTRUCTIONS

1. Have the cadets participate in a warm-up session as per Annex A of EO MX04.01 (Participate in 60 Minutes of Moderate- to Vigorous-Intensity Physical Activity and Track Participation in Physical Activities).
2. Have the cadets perform and score the Cadet Fitness Assessment IAW CATO 14-18.



Have the cadets complete the Cadet Fitness Assessment in pairs. Conduct the 20-m Shuttle Run Test first; conduct the remaining stations as a circuit.

3. Have the cadets participate in a cool-down session as per Annex B of EO MX04.01 (Participate in 60 Minutes of Moderate- to Vigorous-Intensity Physical Activity and Track Participation in Physical Activities).

SAFETY

- Ensure a designated first-aider and first aid kit are available.
- Ensure water is available for the cadets throughout this activity.

CONFIRMATION OF TEACHING POINT 3

The cadets' participation in the Cadet Fitness Assessment will serve as the confirmation of this TP.

END OF LESSONS CONFIRMATION

The cadets' participation in activity will serve as the confirmation of this lesson.

CONCLUSION

HOMEWORK / READING / PRACTICE

Nil.

METHOD OF EVALUATION

Nil.

CLOSING STATEMENT

Participating in the Cadet Fitness Assessment will indicate which of the three components of fitness (cardiovascular endurance, muscular strength and endurance, and muscular flexibility) you need to improve the most. Knowing this will help you set personal goals to improve your physical fitness.

INSTRUCTOR NOTES / REMARKS

The purpose of the Cadet Fitness Assessment is to have cadets measure their personal fitness to help them set individual goals for improvement. Each of the three components of fitness (cardiovascular, muscular strength, and muscular flexibility) are measured, and cadets are assessed using criterion-referenced standards as to whether they are in the healthy fitness zone (HFZ) within each of these components.

The HFZ is the level of fitness needed for good health. Cadets who do not fall within the HFZ for certain components should be coached and encouraged to set goals that will help them improve towards achieving the HFZ in the future.

The Cadet Fitness Assessment shall be set up prior to conducting this EO.

Assistant instructors will be required for this lesson.

The Cadet Fitness Assessment shall be conducted IAW CATO 14-18.

Retain cadets' CFA results for use in EO MX04.03 (Participate in the Cadet Fitness Assessment and identify Strategies for Improving Personal Fitness).

REFERENCES

Canadian Society for Exercise Physiology. (2013). *Guidelines*. Retrieved from: <http://www.csep.ca>

CATO 14-18 Director Cadets 3. (2010). *Cadet fitness assessment and incentive program*. Ottawa, ON: Department of National Defence.

Meredith, M., & Welk, G. (Eds.). (2005). *Fitnessgram / activitygram: Test administration manual (3rd ed.)*. Windsor, ON: Human Kinetics.

The Cooper Institute. (n.d.). *Fitnessgram / activitygram test administration kit: Fitnessgram 8.0 stand-alone test kit*. Windsor, ON: Human Kinetics.

THIS PAGE INTENTIONALLY LEFT BLANK

INTRODUCTION TO GOAL SETTING

OBJECTIVE: This activity is designed to introduce cadets to goal setting.

TIME: 15 min

TRAINING LEVEL: 1

PRE-ACTIVITY INSTRUCTIONS:

Gather the required resources:

- SMART Goals Guide located at Appendix 1 for each cadet, and
- Pens / pencils.

ACTIVITY INSTRUCTIONS:

1. Explain SMART goals to the cadets.

SMART GOALS

Specific. What specific activity can you do to help you reach your goal? Your goal should be concise and focused on one specific outcome (your goal cannot be too vague).

Measurable. How will you measure the achievement of the goal?

Achievable. What might hinder you as you progress towards the goal? What resources can you call upon?

Relevant. What will you get out of this?

Timed. When will you achieve this goal? What will be your first step?

2. Ask the cadets to determine if the following scenario reflects a SMART goal.
Scenario: Cadet Smith and Cadet Trudeau have recently teamed up to motivate each other to become more physically active. They want to get closer to achieving 60 minutes of activity each day. They set a goal to each walk 150 km over the next 30 days, by walking 5 km per day.
Answer: This is a SMART goal. Here is why:
 - **Specific:** The cadets plan to walk 5 kilometres per day for the next 30 days.
 - **Measureable:** They can track the distance spent walking.
 - **Achievable:** It is realistic for each of them to walk 5 km per day. They can reach their goal by working together, providing motivation and support for one another.
 - **Relevant:** Their goal focuses on the aspect of being more physically active. Once they reach their goal, they will experience a sense of accomplishment for completing the task.
 - **Timed:** They have 30 days to reach their goal.
3. Distribute a copy of the SMART Goals Guide located at Appendix 1 to each cadet.
4. Supervise as the cadets set SMART goals linked to meeting the requirements of the *Canadian Physical Activity Guidelines for Youth* and *Canadian Sedentary Behaviour Guidelines for Youth*.
5. As time permits, have the cadets, who wish to, share their SMART goals with the group.

REVIEW OF GOAL SETTING

OBJECTIVE: This activity is designed to review to goal setting.

TIME: 15 min

TRAINING LEVEL: 2–4

PRE-ACTIVITY INSTRUCTIONS:

Gather the required resources:

- SMART Goals Guide located at Appendix 1 for each cadet, and
- Pens / pencils.

ACTIVITY INSTRUCTIONS:

1. Review SMART Goals with the cadets.

SMART GOALS

Specific. What specific activity can you do to help you reach your goal? Your goal should be concise and focused on one specific outcome (your goal cannot be too vague).

Measurable. How will you measure the achievement of the goal?

Achievable. What might hinder you as you progress towards the goal? What resources can you call upon?

Relevant. What will you get out of this?

Timed. When will you achieve this goal? What will be your first step?

2. Give each cadet a copy of the SMART Goals Guide located at Appendix 1.
3. Allow five minutes for cadets to individually complete the handout. Supervise as cadets set SMART goals linked to meeting the requirements of the *Canadian Physical Activity Guidelines for Youth* and *Canadian Sedentary Behaviour Guidelines for Youth*.
4. Divide the cadets into pairs.
5. Supervise as cadets discuss their SMART goals with their partner.
6. As time permits, have the cadets, who wish to, share their SMART goals with the group.



SMART GOALS GUIDE

Rank:	Last Name:
First Name:	Date:

1. Write down your SMART physical fitness goal.

2. Provide a description of how the goal is SMART.

Specific: _____

Measurable: _____

Achievable: _____

Relevant: _____

Timed: _____

3. List some steps that you can take to achieve your goal.

THIS PAGE INTENTIONALLY LEFT BLANK



COMMON TRAINING
ALL TRAINING LEVELS
INSTRUCTIONAL GUIDE
PERSONAL FITNESS
AND HEALTHY LIVING



SECTION 3

**EO MX04.03 – PARTICIPATE IN THE CADET FITNESS ASSESSMENT AND
IDENTIFY STRATEGIES FOR IMPROVING PERSONAL PHYSICAL FITNESS**

Total Time:

One session (3 periods) = 90 min

PREPARATION

PRE-LESSON INSTRUCTIONS

This IG supports EO MX04.03 (Participate in the Cadet Fitness Assessment and Identify Strategies for Improving Personal Physical Fitness) located in A-CR-CCP-701/PG-001, *Royal Canadian Army Cadets Green Star Qualification Standard and Plan*, Chapter 4.

Review CATO 14-18, *Cadet Fitness Assessment and Incentive Program* and become familiar with the material prior to delivering the lesson.

Photocopy the *Individual Score Sheet for the 20-m Shuttle Run Test* located at CATO 14-18, Annex A, Appendix 1 for each cadet.

Photocopy the *Cadet Fitness Assessment and Incentive Level Results* located at CATO 14-18, Annex B, Appendix 3 for each cadet.

Photocopy the Strategies to Improve my Personal Physical Fitness handout located at Annex A for each cadet.

Photocopy Annex B for each assistant instructor.

Refer to the warm-up and the cool-down located at Annexes A and B of EO MX04.01 (Participate in 60 Minutes of Moderate- to Vigorous-Intensity Physical Activity and Track Participation in Physical Activities) for TP 1.

Gather cadets' CFA results from EO MX04.02 (Identify Strategies to Improve Participation in Physical Activities and Participate in the Cadet Fitness Assessment) for use in TP 2.

PRE-LESSON ASSIGNMENT

Nil.

APPROACH

A practical activity was chosen for this lesson as it allows the cadets to participate in the CFA in a safe and controlled environment.

INTRODUCTION

REVIEW

Nil.

OBJECTIVES

By the end of this lesson the cadet shall have participated in the CFA, identified which component of fitness needs the most improvement, identified strategies to improve that component of physical fitness, and set a SMART goal to help improve their personal physical fitness.

IMPORTANCE

It is important for the cadets to participate in the Cadet Fitness Assessment to measure their personal fitness as this will allow them to identify their strengths and their weaknesses. That information will allow cadets to identify strategies and set goals that will guide them towards a healthier lifestyle.

Teaching Point 1**Supervise while the cadets participate in the Cadet Fitness Assessment.**

Time: 60 min

Method: Practical Activity

ACTIVITY

The Cadet Fitness Assessment shall be conducted IAW CATO 14-18, *Cadet Fitness Assessment and Incentive Program*.

OBJECTIVE

The objective of this activity is to have the cadets participate in the Cadet Fitness Assessment.

RESOURCES

- CATO 14-18, *Cadet Fitness Assessment and Incentive Program*,
- Leger 20-m Shuttle Run Test CD,
- Measuring tape,
- CD player,
- Pylons,
- Gym mats,
- 12-cm measuring strips,
- Stopwatches,
- Paper,
- Pens / pencils,
- Metre sticks,
- *Back-saver sit and reach* test apparatuses, and
- *Individual Score Sheet for the 20-m Shuttle Run Test*.

ACTIVITY LAYOUT

Set up the activity IAW CATO 14-18.

ACTIVITY INSTRUCTIONS

1. Have the cadets participate in a warm-up session as per Annex A of EO MX04.01 (Participate in 60 Minutes of Moderate- to Vigorous-Intensity Physical Activity and Track Participation in Physical Activities).
2. Have the cadets perform and score the Cadet Fitness Assessment IAW CATO 14-18.



Have the cadets complete the Cadet Fitness Assessment in pairs. Conduct the 20-m Shuttle Run Test first; conduct the remaining stations as a circuit.

3. Have the cadets participate in a cool-down session as per Annex B of EO MX04.01 (Participate in 60 Minutes of Moderate- to Vigorous-Intensity Physical Activity and Track Participation in Physical Activities).

SAFETY

- Ensure a designated first-aider and first aid kit are available.
- Ensure water is available for the cadets throughout this activity.

CONFIRMATION OF TEACHING POINT 1

The cadets' participation in the Cadet Fitness Assessment will serve as the confirmation of this TP.

Teaching Point 2

Conduct an activity where the cadets identify how to improve their personal physical fitness.

Time: 30 min

Method: Practical Activity

ACTIVITY

OBJECTIVE

The objective of this activity is to have the cadets identify how to improve their personal physical fitness.

RESOURCES

- Cadet Fitness Assessment and Incentive Level Results from EO MX04.02 (Identify Strategies to Improve Participation in Physical Activities and Participate in the CFA), and
- Strategies to Improve My Personal Fitness handout located at Annex A.

ACTIVITY LAYOUT

Nil.

ACTIVITY INSTRUCTIONS

1. Distribute the Strategies to Improve My Personal Fitness handout located at Annex A to each cadet.
2. Have each cadet review their Cadet Fitness Assessment and Incentive Level Results and complete the Strategies to Improve My Personal Fitness handout.
3. With the help of assistant instructors, discuss each cadet's individual results with them and assist them with completing the handout.



A list of example physical activities cadets can do to improve their personal fitness is located at Annex B.

SAFETY

Nil.

CONFIRMATION OF TEACHING POINT 2

The cadets' participation in the activity will serve as the confirmation of this TP.

END OF LESSON CONFIRMATION

The cadets' participation in the activity will serve as the confirmation of this lesson.

CONCLUSION

HOMEWORK / READING / PRACTICE

Nil.

METHOD OF EVALUATION

Nil.

CLOSING STATEMENT

The Cadet Fitness Assessment is a great tool that can help you determine how physically fit you are in the three components of physical fitness (cardiovascular endurance, muscular strength, and muscular flexibility). Knowing where you need to improve will help you target your efforts.

INSTRUCTOR NOTES / REMARKS

The purpose of the Cadet Fitness Assessment is to have cadets measure their personal fitness to help them set individual goals for improvement. Each of the three components of fitness (cardiovascular, muscular strength, and muscular flexibility) are measured, and cadets are assessed using criterion-referenced standards as to whether they are in the healthy fitness zone (HFZ) within each of these components.

The HFZ is the level of fitness needed for good health. Cadets who do not fall within the HFZ for certain components should be coached and encouraged to set goals that will help them improve towards achieving the HFZ in the future.

The Cadet Fitness Assessment shall be set up prior to conducting this EO.

Assistant instructors will be required for this lesson.

The Cadet Fitness Assessment shall be conducted IAW CATO 14-18.

REFERENCES

CATO 14-18 Director Cadets 3. (2010). *Cadet fitness assessment and incentive program*. Ottawa, ON: Department of National Defence.

Meredith, M., & Welk, G. (Eds.). (2005). *Fitnessgram / activitygram: Test administration manual (3rd ed.)*. Windsor, ON: Human Kinetics.

The Cooper Institute. (n.d.). *Fitnessgram / activitygram test administration kit: Fitnessgram 8.0 stand-alone test kit*. Windsor, ON: Human Kinetics.



STRATEGIES TO IMPROVE MY PERSONAL PHYSICAL FITNESS

1. Based on CFA results, which component of fitness do I need to improve the most?

Cardiovascular Endurance?

Muscular Strength?

Muscular Flexibility?

2. What physical activities could I do on a regular basis to help me improve that component of fitness?

3. Set a SMART goal to help improve that component of fitness.

THIS PAGE INTENTIONALLY LEFT BLANK

PHYSICAL ACTIVITIES CADETS CAN DO TO IMPROVE THEIR PERSONAL FITNESS

Examples of physical activities that can help to improve the **cardiovascular endurance component**:

- aerobics,
- basketball,
- cross-country skiing,
- dancing,
- floor hockey,
- hiking,
- ice skating,
- lacrosse,
- orienteering,
- ringette,
- rollerblading,
- running,
- skipping rope,
- snowshoeing,
- soccer, and
- ultimate Frisbee.

Examples of physical activities that can help improve the **muscular strength component**:

- balance ball exercises,
- Pilates,
- resistance exercises using bands,
- resistance exercises using the body,
- weighted ball exercises,
- weighted bar exercises, and
- yoga.

Examples of physical activities that can help improve the **muscular flexibility component**:

- stretching,
- tai chi, and
- yoga.

THIS PAGE INTENTIONALLY LEFT BLANK



**COMMON TRAINING
ALL TRAINING LEVELS
INSTRUCTIONAL GUIDE
PERSONAL FITNESS
AND HEALTHY LIVING**



SECTION 4

**EO CX04.01 – PARTICIPATE IN THE CADET FITNESS ASSESSMENT AND
IDENTIFY STRATEGIES FOR IMPROVING PERSONAL PHYSICAL FITNESS**

Total Time:

One session (3 periods) = 90 min

**THERE IS NO INSTRUCTIONAL GUIDE PROVIDED FOR THIS EO. REFER TO
THE LESSON SPECIFICATION LOCATED IN A-CR-CCP-701/PG-001, ROYAL
CANADIAN ARMY CADETS GREEN STAR QUALIFICATION STANDARD AND PLAN.**

THIS PAGE INTENTIONALLY LEFT BLANK



**COMMON TRAINING
ALL TRAINING LEVELS
INSTRUCTIONAL GUIDE
PERSONAL FITNESS
AND HEALTHY LIVING**



SECTION 5

**EO CX04.02 – PARTICIPATE IN ACTIVITIES THAT REINFORCE
THE THREE COMPONENTS OF PHYSICAL FITNESS**

Total Time:

One session (3 periods) = 90 min

PREPARATION

PRE-LESSON INSTRUCTIONS

This IG supports EO CX04.02 (Participate in Activities that Reinforce the Three Components of Physical Fitness) located in A-CR-CCP-701/PG-001, *Royal Canadian Army Cadets Green Star Qualification Standard and Plan*, Chapter 4.

Select one or two muscular flexibility activities from Annex A, one or two cardiovascular endurance activities from Annex B, and one or two muscular strength activities from Annex C.

Gather the required equipment as per the selected activities.

Print the documents required to conduct the activities.

Refer to the warm-up and the cool-down located at Annexes A and B of EO MX04.01 (Participate in 60 Minutes of Moderate- to Vigorous-Intensity Physical Activity and Track Participation in Physical Activities).

Ensure a designated first-aider and first aid kit are available.

Ensure water is available for the cadets throughout this activity.

PRE-LESSON ASSIGNMENT

Nil.

APPROACH

A practical activity was chosen for this lesson as a fun and interactive way to stimulate interest in the three components of physical fitness.

INTRODUCTION

REVIEW

Nil.

OBJECTIVES

By the end of this activity the cadet shall have participated in activities that reinforce the three components of physical fitness.

IMPORTANCE

It is important for cadets to participate in physical activities that reinforce the three components of physical fitness to help them follow the *Canadian Physical Activity Guidelines for Youth* and *Canadian Sedentary Behaviour Guidelines for Youth* and lead a healthy active lifestyle.

ACTIVITY

1. Have the cadets participate in a warm-up session as per of EO MX04.01 (Participate in 60 Minutes of Moderate- to Vigorous-Intensity Physical Activity and Track Participation in Physical Activities).
2. Conduct the selected activities from Annexes A, B and C.



The Three Components of Physical Fitness

Cardiovascular Endurance. The ability of the body's cardiovascular and respiratory systems to supply oxygen and blood during sustained physical activity (eg, the ability to run a long distance).

Muscular Strength. The ability of a muscle or muscle group to contract many times without tiring (eg, rowing a boat).

Muscular Flexibility. The range of motion of joints or a group of joints. It also refers to the freedom and efficiency in which a joint moves. (eg, the shoulder flexibility required to scratch your back.)

3. Have the cadets participate in a cool-down session as per Annex B of EO MX04.01 (Participate in 60 Minutes of Moderate- to Vigorous-Intensity Physical Activity and Track Participation in Physical Activities).

CONCLUSION

METHOD OF EVALUATION

Nil.

CLOSING STATEMENT

Finding activities that are enjoyable is a great way to follow the *Canadian Physical Activity Guidelines* and *Canadian Sedentary Behaviour Guidelines*, and to lead a healthy active lifestyle.

INSTRUCTOR NOTES / REMARKS

Nil.

REFERENCES

ISBN 0-934387-29-X Panicucci, J. (2008). *Achieving Fitness: An Adventure Activity Guide*. Beverly, MA: Project Adventure, Inc

**FLEXIBILITY ACTIVITY 1:
THE ARTISTS**

OBJECTIVE: This activity is designed to help cadets improve their muscular flexibility.

TIME: 10–20 min

PRE-ACTIVITY INSTRUCTIONS:

Gather the required resources:

- Four images (eg, a provincial / territorial flag, image from a colouring book, famous person)
- Paper,
- Pen / pencil, and
- Masking Tape.

ACTIVITY INSTRUCTIONS:

1. Divide the cadets into groups of two or three.
2. Have each group tape a piece of paper to the floor.
3. Explain to the cadets that:
 - (a) The aim of the activity is to draw the best possible picture, as a group.
 - (b) Legs and arms must remain as straight as possible.
 - (c) The pen or pencil must be held by all team members.
 - (d) Each group will have to draw the image provided.
4. Supervise as the cadets participate in the activity.
5. As time allows, have cadets repeat the activity, with a different image, in different groups.

**FLEXIBILITY ACTIVITY 2:
CIRCLE THE CIRCLE**

OBJECTIVE: This activity is designed to help cadets improve their muscular flexibility.

TIME: 10–20 min

PRE-ACTIVITY INSTRUCTIONS:

Gather hula hoops (one per team).

ACTIVITY INSTRUCTIONS:

1. Divide the cadets into equal teams of four or more cadets.
2. Have the cadets in each team stand in a circle and grasp each other's forearms.
3. Explain to the cadets that they will have to pass a hula hoop around the circle without letting go of each other's arms.
4. Give the signal to start and supervise as the cadets participate in the activity. Allow the cadets to repeat the activity so they can improve their performance.
5. Divide the cadets into different teams. Repeat the activity.
6. As time allows, have the cadets perform the activity as one large team with multiple hula hoops going around the circle.

**FLEXIBILITY ACTIVITY 3:
BEAR SOCCER**

OBJECTIVE: This activity is designed to help cadets improve their muscular flexibility.

TIME: 10–20 min

PRE-ACTIVITY INSTRUCTIONS:

1. Gather the required resources:
 - (a) Two goals (eg, hockey nets, pylons, taped outline on a wall, books, etc.),
 - (b) Boundary markers (eg, pylons, tape, etc.),
 - (c) Light ball (eg, soccer, nerf, dodge, tennis, beach, etc.), and
 - (d) Whistle.
2. Set up a goal on each side of the playing area and identify the centre of the field.

ACTIVITY INSTRUCTIONS:

1. Divide the cadets into two teams.
2. Explain to the cadets that :
 - (a) The objective is to score more goals than the opposite team.
 - (b) To move around players must assume the bear position: hands and feet on the floor with their buttocks in the air.
 - (c) Only feet (no hands!) can be used to stop or move the ball.
 - (d) Play is stopped for a goal or an infraction (indicated with a whistle blow). In this case, possession of the ball is switched to the other team. Players of both teams retreat to their side of the playing field and the ball is placed in the centre of the playing field. All players must be on their side of the field until the ball is touched. The team in possession of the ball must be given 10 feet of room until the ball is touched.
 - (e) Infractions include: touching the ball with the hands, kicking the ball out of bounds, standing up, or poor conduct.
3. Start the game and supervise as the cadets participate in the activity.

THIS PAGE INTENTIONALLY LEFT BLANK

**CARDIOVASCULAR ENDURANCE ACTIVITY 1:
STRIKEFORCE TAG**

OBJECTIVE: This activity is designed to help cadets improve their cardiovascular fitness.

TIME: 10–20 min

PRE-ACTIVITY INSTRUCTIONS:

Nil.

ACTIVITY INSTRUCTIONS:

1. Divide the cadets into groups of at least four.
2. Explain to the cadets that :
 - (a) The goal of this activity is to avoid being tagged by “STRIKEFORCE”.
 - (b) A cadet is designated “STRIKEFORCE” and the remaining cadets join hands and form a small circle.
 - (c) One of the cadets in the circle is identified as the target of “STRIKEFORCE”. Cadets in the circle must work together to keep the target cadet from being tagged by “STRIKEFORCE”.
 - (d) Once the target is tagged, that cadet becomes the new “STRIKEFORCE”. The cadet that was “STRIKEFORCE” joins the circle of cadets. A new cadet becomes the target (not the cadet who was just “STRIKEFORCE”).
3. Ask for a volunteer to be “STRIKEFORCE”.
4. Start the game and supervise as the cadets participate in the activity.

**CARDIOVASCULAR ENDURANCE ACTIVITY 2:
OVER UNDER RELAY**

OBJECTIVE: This activity is designed to help cadets improve their cardiovascular fitness.

TIME: 10–20 min

PRE-ACTIVITY INSTRUCTIONS:

1. Gather the required resources:
 - (a) One ball per team (basketball, dodge, volleyball, tennis, medicine, etc), and
 - (b) Whistle.
2. Determine the number of legs / length of the race and playing field size prior to beginning the activity.

ACTIVITY INSTRUCTIONS:

1. Divide the cadets into teams of three and issue a ball per team.
2. Explain to the cadets that :
 - (a) The goal of this activity is to be the first team to complete the race.
 - (b) All cadets in a team must stand in line, all facing the direction opposite to where they are headed. The cadet in front must pass the ball over their head to their partner in the back, who passes the ball behind their legs to the partner behind them.
 - (c) As soon as they have passed the ball, cadets must run to the back of the line.
 - (d) This continues until the team travels the distance indicated. (Announce the distance required to complete the race.)
 - (e) Both cadets must touch the ball for a proper pass (it cannot be thrown or tossed).
3. Start the race and supervise as the cadets participate in the activity.

**CARDIOVASCULAR ENDURANCE ACTIVITY 3:
BRITISH BULLDOG**

OBJECTIVE: This activity is designed to help cadets improve their cardiovascular fitness.

TIME: 10–20 min

PRE-ACTIVITY INSTRUCTIONS:

1. Gather the required resources:
 - (a) Boundary markers (tape, pylons, rope, etc), and
 - (b) Whistle.
2. Set up the boundaries: A large rectangle of the open space.

ACTIVITY INSTRUCTIONS:

1. Explain to the cadets that:
 - (a) One cadet is designated as the bulldog; they stand in the center of the open space.
 - (b) The remainder of the cadets line up at one end of the playing area.
 - (c) The blowing of a whistle signals the cadets to run across the area to the other line.
 - (d) The bulldog(s) tries to tag as many cadets as possible.
 - (e) Any of the cadets tagged also become bulldogs.
 - (f) If someone runs out of bounds, they become a bulldog. (Point out the boundaries of the activity).
 - (g) The game continues until only one cadet remains untagged. This cadet is declared the winner.
2. Identify one cadet as the bulldog.
3. Have the cadets line up at one end of the playing area.
4. Start the activity and supervise as the cadets participate in the activity.

**CARDIOVASCULAR ENDURANCE ACTIVITY 4:
MONEY GRAB**

OBJECTIVE: This activity is designed to help cadets improve their cardiovascular fitness.

TIME: 10–20 min

PRE-ACTIVITY INSTRUCTIONS:

1. Gather the required resources:
 - (a) Hula hoops (one per team),
 - (b) Monopoly money, and
 - (c) Whistle.
2. Prepare the activity area, by spreading hula hoops on the playing area evenly.
3. Deposit \$1000 in each hula hoop using different denominations (\$100x6, \$50x4, \$20x5, \$10x10).

ACTIVITY INSTRUCTIONS:

1. Divide cadets into equal teams.
2. Explain to the cadets that:
 - (a) Each team of cadets has a hula hoop: it is called the bank.
 - (b) The aim is to be the team who ends up with the most money in their bank.
 - (c) Cadets can withdraw money from the other teams' bank and deposit it in their own.
 - (d) A cadet can only hold one bill at a time.
 - (e) This continues until time runs out.
3. Start the game and supervise as the cadets participate in the activity.
4. When time has run out, ask each team to count the money in their bank and announce a winning team.

**CARDIOVASCULAR ENDURANCE ACTIVITY 5:
RUBBER CHICKEN BASEBALL**

OBJECTIVE: This activity is designed to help cadets improve their cardiovascular fitness.

TIME: 10–20 min

PRE-ACTIVITY INSTRUCTIONS:

1. Gather the required resources:
 - (a) Rubber chicken (or suitable substitute),
 - (b) Boundary markers (tape, pylons, rope, etc), and
 - (c) Whistle.
2. Identify the playing field boundaries: A large open space.

ACTIVITY INSTRUCTIONS:

1. Divide the cadets into two equal teams.
2. Explain to the cadets that:
 - (a) There are two teams: HOME and AWAY.
 - (b) The HOME team begins the game by throwing the chicken within the playing area.
 - (c) The AWAY team begins Fielding the Chicken first.
 - (d) The AWAY team runs up to the chicken and forms a single file, facing the chicken.
 - (e) The AWAY team passes the chicken over under through their file. The first cadet passes the chicken between their legs to the cadet behind them, who passes it over their head to the next cadet in line, and so on.
 - (f) Once the chicken has passed through the entire team, the last cadet crows like a rooster.
 - (g) During that time the HOME team forms a line and races around the AWAY team. Each complete lap around the AWAY team before they crow is scored a run.
 - (h) After the rooster crows, the rooster throws the chicken anywhere in the playing area and the roles are reversed; the AWAY team becomes the HOME team and vice versa.
 - (i) If the chicken is thrown out-of-bounds, that team has to pass the chicken through their line again.
 - (j) The team with the most runs wins.
3. Randomly designate one team of cadets HOME, and the other team AWAY.
4. Start the game and supervise as the cadets participate in the activity.

THIS PAGE INTENTIONALLY LEFT BLANK

**MUSCULAR STRENGTH AND ENDURANCE ACTIVITY 1:
WHEELBARROW RELAY**

OBJECTIVE: This activity is designed to help cadets improve their muscular strength and endurance.

TIME: 10–20 min

PRE-ACTIVITY INSTRUCTIONS:

1. Gather the required resources:
 - (a) Items to be carried (eg, balls, books, shoes), and
 - (b) Whistle.
2. Set up the boundaries of the race area.
3. Set up the items to be carried for each team. Note: Each item in the pile means that one cadet will have to carry it across the race area.

ACTIVITY INSTRUCTIONS:

1. Divide the cadets into pairs.
2. Explain to the cadets that:
 - (a) All items in the pile need to be delivered to the other side of the field.
 - (b) Items can only be delivered via the back of a cadet in the wheelbarrow position.
 - (c) Only one item may be brought at a time.
 - (d) Cadets must alternate positions (wheelbarrow and holder), until all items have been brought to the other side of the field.
 - (e) When an item is dropped midway, it must be brought back to the start.
3. Start the game and supervise as the cadets participate in the activity.

**MUSCULAR STRENGTH AND ENDURANCE ACTIVITY 2:
SOUP CAN PYRAMID**

OBJECTIVE: This activity is designed to help cadets improve their muscular strength and endurance.

TIME: 10–20 min

PRE-ACTIVITY INSTRUCTIONS:

Gather the required resources:

- A minimum of three cans (eg, soup, vegetables, etc.) per cadet,
- Whistle.

ACTIVITY INSTRUCTIONS:

1. Divide the cadets into pairs.
2. Explain to the cadets that:
 - (a) Cadets must use their feet to move cans together.
 - (b) Legs must remain straight.
 - (c) The team must create a line of cans and then stack them until they form a pyramid.
 - (d) Only one can be moved at a time.
 - (e) Cadets must dismantle their pyramid before continuing to their next appendage.
 - (f) Cadets must then build a pyramid using their other foot.
 - (g) The activity can be repeated with cadets using their hands while lying on their stomach.
3. Have the cadets lay down on their backs on the floor.
4. Have each cadet place the bottoms of their feet against their partner's feet.
5. On either side of the legs of each team of cadets, place a collection of cans.
6. Blow the whistle to start the game.
7. Supervise as the cadets participate in the activity.



Canned food could be donated to the local food bank.

**MUSCULAR STRENGTH AND ENDURANCE ACTIVITY 3:
YURT CIRCLES**

OBJECTIVE: This activity is designed to help cadets improve their muscular strength and endurance.

TIME: 10–20 min

PRE-ACTIVITY INSTRUCTIONS:

Nil.

ACTIVITY INSTRUCTIONS:

1. Divide the cadets into two teams of at least three cadets each.
2. Have the teams form circles.
3. Explain to the cadets that:
 - (a) All cadets in one team will perform a leg squat at the same time, while holding arms. Cadets will raise one leg while performing the squat and then the other leg.
 - (b) Each team will attempt the same thing while holding hands or forearms.
 - (c) Then, both teams will squat to see which team can hold the squat the longest.
 - (d) As time allows, have the cadets attempt the activity again as one large group or in different teams.
4. Supervise as the cadets participate in the activity.

**MUSCULAR STRENGTH AND ENDURANCE ACTIVITY 4:
CRAB SOCCER**

OBJECTIVE: This activity is designed to help cadets improve their muscular strength and endurance.

TIME: 10–20 min

PRE-ACTIVITY INSTRUCTIONS:

1. Gather the required resources:
 - (a) Two goals (eg, hockey nets, pylons, taped outline on a wall, books, etc.),
 - (b) Boundary markers (eg, pylons, tape, etc.),
 - (c) Light ball (eg, soccer, nerf, dodge, tennis, beach, etc.), and
 - (d) Whistle.
2. Set up a goal on each side of the playing area and identify the centre of the field.

ACTIVITY INSTRUCTIONS:

1. Divide the cadets into two teams.
2. Explain to the cadets that:
 - (a) The objective is to score more goals than the opposing team.
 - (b) To move around players must assume the table position: hands (behind the back) and feet on the floor with the torso up.
 - (c) Only feet (no hands!) can be used to stop or move the ball.
 - (d) Play is stopped for a goal or an infraction (indicated with a whistle blow). In this case, possession of the ball is switched to the other team. Players of both teams retreat to their side of the playing field and the ball is placed in the centre of the playing field. All players must be on their side of the field until the ball is touched. The team in possession of the ball must be given 10 feet of room until the ball is touched.
 - (e) Infractions include: touching the ball with the hands, kicking the ball out of bounds, standing up, or poor conduct.
3. Start the game and supervise as the cadets participate in the activity.



**COMMON TRAINING
ALL TRAINING LEVELS
INSTRUCTIONAL GUIDE
PERSONAL FITNESS
AND HEALTHY LIVING**



SECTION 6

EO CX04.03 – PARTICIPATE IN A COOKING CLASS

Total Time:

One session (3 periods) = 90 min

**THERE IS NO INSTRUCTIONAL GUIDE PROVIDED FOR THIS EO. REFER TO
THE LESSON SPECIFICATION LOCATED IN A-CR-CCP-701/PG-001, ROYAL
CANADIAN ARMY CADETS GREEN STAR QUALIFICATION STANDARD AND PLAN.**

THIS PAGE INTENTIONALLY LEFT BLANK



**COMMON TRAINING
ALL TRAINING LEVELS
INSTRUCTIONAL GUIDE
PERSONAL FITNESS
AND HEALTHY LIVING**



SECTION 7

EO CX04.04 – ATTEND A PERSONAL FITNESS AND HEALTHY LIVING PRESENTATION

Total Time:

One session (3 periods) = 90 min

**THERE IS NO INSTRUCTIONAL GUIDE PROVIDED FOR THIS EO. REFER TO
THE LESSON SPECIFICATION LOCATED IN A-CR-CCP-701/PG-001, ROYAL
CANADIAN ARMY CADETS GREEN STAR QUALIFICATION STANDARD AND PLAN.**

THIS PAGE INTENTIONALLY LEFT BLANK



**COMMON TRAINING
ALL TRAINING LEVELS
INSTRUCTIONAL GUIDE
PERSONAL FITNESS
AND HEALTHY LIVING**



SECTION 8

EO CX04.05 – ATTEND A LOCAL AMATEUR SPORTING EVENT

Total Time:

One session (3 periods) = 90 min

**THERE IS NO INSTRUCTIONAL GUIDE PROVIDED FOR THIS EO. REFER TO
THE LESSON SPECIFICATION LOCATED IN A-CR-CCP-701/PG-001, ROYAL
CANADIAN ARMY CADETS GREEN STAR QUALIFICATION STANDARD AND PLAN.**

THIS PAGE INTENTIONALLY LEFT BLANK

CHAPTER 5

PO X05 – PARTICIPATE IN PHYSICAL ACTIVITIES



**COMMON TRAINING
ALL TRAINING LEVELS
INSTRUCTIONAL GUIDE
PHYSICAL ACTIVITIES**



SECTION 1

EO MX05.01 – PARTICIPATE IN PHYSICAL ACTIVITIES

Total Time:

3 sessions (9 periods) = 270 min

PREPARATION

PRE-LESSON INSTRUCTIONS

This IG supports EO MX05.01 (Participate in Physical Activities) located in A-CR-CCP-701/PF-001, *Royal Canadian Army Cadets, Green Star Qualification Standard and Plan*, Chapter 4.

Refer to the warm-up and the cool-down located at Annexes A and B of EO MX04.01 (Participate in 60 Minutes of Moderate- to Vigorous-Intensity Physical Activity and Track Participation in Physical Activities).

Select a physical activity to conduct.

Gather the required equipment as per the selected activities.

Assistant instructors / specialists may be required based on the activity selected.



Suggested physical activities are located at the attachments to this IG as follows:

Cardiovascular Activities, including:

- Attachment A - Aerobics,
- Attachment B - Cross-Country Skiing,
- Attachment C - Hiking,
- Attachment D - Ice Skating,
- Attachment E - Instructor-Led Dancing,
- Attachment F - Orienteering,
- Attachment G - Rollerblading,
- Attachment H - Running,
- Attachment I - Skipping Rope,
- Attachment J - Snowshoeing, and
- Attachment K - Swimming.

Muscular Strength Activities, including:

- Attachment L – Muscular Strength Exercises using the Body, Balance Balls, Resistance Bands, and Weighted Balls and Bars,
- Attachment M - Pilates,

Muscular Flexibility Activities, including:

- Attachment N - Stretching,
- Attachment O - Tai Chi, and
- Attachment P - Yoga.

Recreational Team Sports, including:

- Attachment Q - Baseball,
- Attachment R - Basketball,
- Attachment S - Floor Hockey,
- Attachment T - Football (Flag or Touch),
- Attachment U - Lacrosse,
- Attachment V - Ringette,
- Attachment W - Soccer,
- Attachment X - Soccer Baseball,
- Attachment Y - Softball,
- Attachment Z - Ultimate Frisbee, and
- Attachment AA - Volleyball.

Other Physical Activities, including:

- Attachment AB - Active Games,
- Attachment AC - Circuit Training,
- Attachment AD - Martial Arts, and
- Attachment AE - Tabloids.

PRE-LESSON ASSIGNMENT

Nil.

APPROACH

A practical activity was chosen for this lesson as it allows the cadets to participate in physical activities in a safe and controlled environment.

INTRODUCTION

REVIEW

Nil.

OBJECTIVES

By the end of this lesson the cadet shall be expected to have participated in physical activities.

IMPORTANCE

It is important for cadets to participate in physical activities to identify activities that are fun and to promote lifelong participation in physical activity.

Teaching Point 1

Have the cadets participate in physical activities.

Time: 9 x 30 min

Method: Practical Activity

ACTIVITY

OBJECTIVE

The objective of this activity is to provide the cadets an opportunity to participate in physical activities.

RESOURCES

- Equipment / safety equipment required for the selected physical activity, and
- First aid equipment.

ACTIVITY LAYOUT

Activity layout will depend on the selected physical activity.

ACTIVITY INSTRUCTIONS

1. Introduce the selected physical activity, to include:
 - (a) which component(s) of fitness are improved through participation in the selected physical activity, and
 - (b) techniques for participating in the selected physical activity.
2. Have the cadets participate in a safety briefing, to include:
 - (a) rules / regulations of the selected physical activity,
 - (b) requirement for safety equipment for the selected physical activity,
 - (c) location of first aid post, and
 - (d) boundaries or route information.
3. Have the cadets participate in a warm-up session as per Annex A of EO MX04.01 (Participate in 60 Minutes of Moderate- to Vigorous-Intensity Physical Activity and Track Participation in Physical Activities).
4. Have the cadets participate in the selected physical activity.
5. Have the cadets participate in a cool-down session as per Annex B of EO MX04.01 (Participate in 60 Minutes of Moderate- to Vigorous-Intensity Physical Activity and Track Participation in Physical Activities).

SAFETY

- Ensure constant supervision throughout the activity.
- Ensure a first aid post / kit is readily accessible.
- Ensure a first-aider is identified at the start of the activity and is available at all times.
- Ensure cadets remain hydrated throughout the activity.

CONFIRMATION OF TEACHING POINT 1

The cadets' participation in the physical activity will serve as the confirmation of this TP.

END OF LESSON CONFIRMATION

The cadets' participation in the physical activity will serve as the confirmation of this lesson.

CONCLUSION

HOMEWORK / READING / PRACTICE

Nil.

METHOD OF EVALUATION

Nil.

CLOSING STATEMENT

Participating in physical activities can help you:

- improve your health;
- do better in school;
- improve your fitness;
- grow stronger;
- have fun being active with friends;
- feel happier;
- maintain a healthy body weight;
- improve your self-confidence; and
- learn new skills.

INSTRUCTOR NOTES / REMARKS

The aim of this lesson is for cadets to have fun participating in physical activities. Choose activities the cadets will enjoy. Survey cadets to determine those physical activities in which they are interested.

Several physical activities may be conducted concurrently. Choice is an important factor when it comes to enjoying physical activity. The more varying types of physical activities cadets are exposed to, the more likely they are to find an activity they will be interested in pursuing on a regular basis.

Choose activities based on human and material resources accessible to the corps / squadron.

Fitness videos (conducted by a certified trainer), certified trainers and Canadian Forces Personnel Support Programs (PSP) staff may be used to conduct this training.

Activities chosen for this training are not limited to the lists presented above but must be age appropriate, safe, and in-line with the aim of promoting physical fitness.

Physical activity periods may be conducted consecutively to provide the cadets an opportunity to participate in longer, varied physical activities.

REFERENCES

- About Ultimate. (2006). *About ultimate*. Retrieved October 30, 2006, from <http://www.upa.org/ultimate>
- Alberta Centre for Active Living. (2007). *What should parents know about strength training for youth ages 12 to 17?* Retrieved October 4, 2011 from <http://www.centre4activeliving.ca/our-work/faq/strength-train.pdf>
- Anderson, B. (2000). *Stretching: 20th anniversary* (Rev. ed.). ISBN 0-936070-22-6. Bolinas, CA: Shelter Publications, Inc
- Bagshaw, C. (Ed.). (2006). *The ultimate hiking skills manual*. ISBN 978-0-7153-2254-3. Cincinnati, OH: David & Charles
- Berger, K. (2005). *Backpacking & hiking*. ISBN 0-7566-0946-1. New York, NY: DK Publishing, Inc
- Body Bar. (2010). *Programs & education*. Retrieved October 5, 2011, from <http://www.bodybar.com/Programs-Education>
- Canadian Orienteering Federation (1983). A-CR-CCP-151/PT-001 *Orienteering Level 1 Coaching Certification*. National Coaching Certification Program, Canadian Orienteering Federation.
- Canadian Orienteering Federation (1985). *Orienteering Level Two Coaching Certification*.
- Chapman, J.R. Major, M.B.E. (1968). A-CR-CCP-150/PT-001 *Orienteering: an Aid to Training*. London, England: Hillside Printing & Publishing Co.
- Corbin, C., & Lindsey, R. (2007). *Fitness for life: Updated fifth edition*. ISBN 978-0-7360-6675-4. Windsor, ON: Human Kinetics
- Curtis, R. (2005). *The backpacker's field manual: A comprehensive guide to mastering backcountry skills*. ISBN 1-4000-5309-9. New York, NY: Three Rivers Press
- Director Cadets 3. (2006). A-CR-CCP-951/PT-002. *Royal Canadian Army Cadets adventure training safety standards*. Ottawa, ON: Department of National Defence.
- Faigenbaum, A. Ed. & Micheli, L. (1998). *Youth strength training*. Retrieved October 4, 2011, from http://www.acsm.org/AM/Template.cfm?Section=Current_Comments1&Template=/CM/ContentDisplay.cfm&ContentID=8657
- Graydon, D., & Hanson, K. (Eds.). (2001). *Mountaineering: The freedom of the hills* (6th ed.). ISBN 0-89886-427-5 Seattle, WA: The Mountaineers
- Hanlon, T. (1998). *The sports rules book: Essential rules for 54 sports*. ISBN 0-88011-807-5. USA: Human Kinetics Publishers, Inc.
- International Orienteering Federation (2006). Retrieved 20 April 2006, from <http://www.orienteering.org/footer/pictsymb.htm>.
- Kjellstrom, B. (1994). *Be Expert With Map & Compass: The Complete Orienteering Handbook*. ISBN 0-02-029265-1. New York: Hungry Minds, Inc.
- LeBlanc, J., & Dickson, L. (1997). *Straight talk about children and sport: Advice for parents, coaches, and teachers*. ISBN 0-88962-630-8. Oakville, ON: Mosaic Press.
- Livestrong.com. (2011). *Beginner's Pilates exercises*. Retrieved October 4, 2011, from <http://www.livestrong.com/article/452265-beginner-pilates-exercises/>
- Lose the Back Pain (2006). Retrieved April 25, 2006, from www.losethebackpain.com

- Men's Health. (2011). *The 5-minute six-pack abs*. Retrieved October 5, 2011, from <http://www.menshealth.com.sg/fitness/5-minute-six-pack-abs>
- Norris, G. (Ed.). (1998). *National Football Federation: Touch football rule book 2004*. Ottawa, ON: National Football Federation
- Panicucci, J. (2008). *Achieving Fitness: An Adventure Activity Guide*. ISBN 0-934387-29-X. Beverly, MA: Project Adventure, Inc
- Popovic, Srdjan. (2011). *10 Skipping Rope Exercises for a Better Body*. Retrieved October 6, 2011, from <http://www.bloomtofit.com/10-skipping-rope-exercises-for-a-better-body>
- Ringette Canada. (2006). *How ringette is played*. Retrieved October 30, 2006, from <http://www.ringette.ca/e/about/played.htm>
- Roadcycling (2006). Retrieved April 25, 2006, from www.roadcycling.com/artman/upload/stretch.es.jpg
- Shelter Online (2006). Retrieved April 25, 2006, from www.shelterpub.com/_fitness/online_stretches.gif
- Spine Universe. Retrieved April 25, 2006, from www.spineuniverse.com
- Sports fitness advisor. (n.d.). *Medicine ball exercises*. Retrieved October 5, 2011, from <http://www.sport-fitness-advisor.com/medicine-ball-exercises.html>
- Stott, W. (1987). *Armchair Orienteering II: A Practical Guide to Route Planning*. Winnipeg: Manitoba Orienteering Association.
- What is Ultimate Frisbee? (2006). *What is ultimate – the game*. Retrieved October 30, 2006, from http://www.whatisultimate.com/what/what_game_en.html
- Waehner, P. (n.d.). *Resistance band workout for beginners*. Retrieved October 5, 2011 from <http://exercise.about.com/library/bltotalresistancebeginners.htm>
- Walkablock Club of America (2005). Retrieved April 25, 2006, from www.walkablock.com/stretch2.gif
- Women's Heart Foundation (1999-2000). Retrieved April 25, 2006, from www.womensheart.org/content/Exercise/stretching_exercise.asp

THIS PAGE INTENTIONALLY LEFT BLANK

AEROBICS

INTRODUCTION

Aerobic exercise is physical exercise of relatively low intensity and long duration, which depends primarily on the aerobic energy system.

EQUIPMENT

The equipment required will vary based on the selected type of aerobic activity.

ACTIVITY GUIDELINES

Aerobic activities shall be tailored to accommodate a variety of fitness levels. Encourage cadets to participate at their highest level to fully maximize the benefits of aerobic activities.

EXAMPLES OF AEROBIC ACTIVITIES

Step Exercises. Step exercises usually involve an elevated step that the participant steps on and off of. Intensity can be increased by increasing movement speed or the height of the step being used.

Exercise Equipment. Exercise equipment can be used to provide individual aerobic training or in organised classes such as spin class (a group class that uses exercise bikes). Examples include exercise bikes, elliptical trainers, rowing machines, step machines, and treadmills.

Jazzercise. Jazzercise was created in 1969 by Judi Sheppard Missett. It combines aspects of dance with resistance training, Pilates, yoga, and kickboxing. Jazzercise is ranked one of the top fitness programs in the world with over 7800 instructors in 38 countries.

Tae Bo. Made popular in the 1990s, Tae Bo is an exercise routine that uses martial arts at a quick pace to increase the heart rate. It was developed by Billy Banks, an actor turned fitness consultant.

SUGGESTED RESOURCES

Judi Sheppard Missett, Certified Jazzercise Instructor. *Jazzercise Core: Target & Tone Muscle, Fat Burning, Strength Building*. 2009. [DVD]

Judi Sheppard Missett, Certified Jazzercise Instructor. *Jazzercise: Live*. 2008. [DVD]

Billy Banks, Certified Tae Bo Instructor. *This is Tae Bo*. 2010. [DVD]

Billy Banks, Certified Tae Bo Instructor. *Cardio Explosion*. 2010. [DVD]

THIS PAGE INTENTIONALLY LEFT BLANK

CROSS-COUNTRY SKIING

INTRODUCTION

Cross-country skiing is a sport that requires very little skill. However, understanding stroke mechanics and techniques will make skiing more efficient and enjoyable.

EQUIPMENT

Skis. The chart below is a rough guide to follow when selecting a ski length.

Ski Length	Carrying Capacity
168 cm	90–130 lb
168, 178 cm	130–150 lbs
178, 188 cm	150–180 lbs
188 cm	180–220 lbs

Ski Boots. Skis are guided and controlled through the boots, so it is important that they fit well. Boots are made from a variety of materials, from all leather to modelled plastic to a combination of materials. Lighter boots provide more freedom but offer less support. Heavier boots provide more support but usually restrict movement and are harder to fit. Boots that are too tight / loose may cause the skier incredible discomfort and may result in injuries such as blisters.

Ski Poles. Ski poles are an integral part of cross-country ski equipment. Most techniques in cross-country skiing require the skier to not only use their skis, but their arms (poles) as well. Ski poles help the skier maintain balance while climbing inclines, when going downhill and when going forward.

ACTIVITY GUIDELINES

Cross-country skiing shall be limited to new fallen snow, powder snow, and wind-packed snow. It shall also be conducted on novice / beginner trails.

New Fallen Snow. Very loose and light. The snowflakes still have multiple branches. If new snow is dry, it is feathery; if damp, it quickly consolidates into a stage of settled snow.

Powder Snow. New, untouched freshly fallen soft snow. It can give the feeling of floating in a weightless environment. Powder snow can be packed in thick layers that form a natural pillow. Powder snow has a low moisture content, as almost 97 percent of it is air.

Wind-Packed Snow. Snow blown from one direction, compacted by the force of the wind. Wind-packed snow is created by the pressure exerted by wind, causing a form of cold-heat hardening.

The following types of snow should be avoided when conducting cross-country skiing:

Sun Crust Snow. Snow that has had the upper layer melt and then refreeze. Usually on top of powder snow, sun crust snow is stronger than the powder snow below it due to the refreezing. This snow can be dangerous to cross-country ski on if on a slope; the crust may give way and a person may lose their footing. Cross-country skiing on a flat surface over sun crust snow can be difficult as the skis break through the crust and can hook into the crust on the return. The constant hooking and breaking in sun crusted snow can quickly tire the cross-country skier.

Corn Snow. Corn snow occurs after thawing, usually in the spring. It is produced during the cycle of melting and refreezing in the accumulated snow. The structure of the snow is very grainy. Corn snow can be strong enough to carry weight, but can also indicate the presence of rotten snow, which is very dangerous.

Rotten Snow. Caused by repeated melting and freezing and is found mostly on the south side of hills, or in lower levels of snow. Water will seep to the lower layers and will not freeze because it is insulated from the weather by the covering snow layer. Rotten snow can resemble very small icicles, or candle ice. This snow is dangerous. Sudden drops and holes may exist under the surface of the snow. Falling and injury are highly possible.

Slush Snow. When the air temperature becomes warmer than the freezing point, the snow begins to melt and the water content becomes high. Slush snow absorbs water from melting snow. Slush snow is recognizable by depressions in the snow with darker or bluish snow areas. These areas show holes in the ice or an accumulation of water on the surface of the ice.

CROSS-COUNTRY SKIING TECHNIQUES

Falling Down

Falling down is a common occurrence when cross-country skiing. It is not the falling that is difficult when cross-country skiing; getting up after the fall is what most struggle with.

When losing balance and about to fall:

1. Check the area for rocks or tree stumps to avoid, if possible.
2. Sit down to one side or the other of the skis.
3. Keep the legs below the rest of the body.
4. Dig the skis into the snow to stop any forward momentum.

To get up after a fall:

1. Roll onto the back and stick legs, arms, skis and poles into the air to untangle them.
2. Bend the knees and place the skis flat on the ground, concurrently sliding the hips towards the feet and the backs of the skis under the behind.
3. Come to one knee (plant the poles at the sides to assist).
4. Stand up.

Stopping

For their own safety and for the safety of those around them, it is extremely important that cadets are able to slow down and stop themselves on flat ground and on hills. The principles for both are the same and require the cadet to have constant control of their body and their skis. A cross-country ski glides most effectively when it is flat on the ski base. A ski begins to lose forward momentum as soon as it is tipped to either edge.

Therefore, to stop, the skier must tip the ski to the edge—this is called edging.



The wedge position is sometimes referred to as the snowplow position. Some may be more familiar with this term as it is also used in downhill skiing.

There are two types of wedging:

- the half wedge, and
- the full wedge.

To slow down / stop using the half wedge:

1. Decide which ski to move into the half wedge position.
2. Keep the skis parallel to each other.
3. Move into the half wedge position by:
 - (a) bringing the knees together;
 - (b) keeping the tips of the skis together; and
 - (c) moving the tail of the desired ski outward by pushing the heel out and the toes inward.
4. Angle the inside edge of the wedged ski into the snow by rolling the ankle inward (the more the edge is angled into the snow, the faster the skier will slow down / stop).

To slow down / stop using the full wedge:

1. Sink into a crouch.
2. Bring the knees together and point them toward the tips of the skis.
3. Keep the tips of the skis together (but not touching).
4. Move the tails of the skis outward by pushing the heels outward and the toes inward.
5. Angle the inside edges of the skis into the snow by rolling the ankles inwards (the more the edge is angled into the snow, the faster the skier will slow down / stop).

Changing Direction

Whenever on cross-country skis there is always a requirement to change direction of travel. It is a fairly simple process that requires practice in order to perfect.

Changing direction can be carried out by picking up the tip, the tail or the entire ski, one at a time, and moving it toward the new direction of travel—then repeating the process with the other ski. Depending on the degree of the turn, the skier may need to complete this process a number of times before reaching the desired direction.

To change direction:

1. Assume the half-sitting position.
2. Move the left (right) ski forward until the left (right) boot toe is just ahead of the right (left) boot toe.
3. Lift the tip of the left (right) ski about 30 cm (1 foot) off the ground.
4. Move the lifted ski slightly to the left (right), about an arc of 30 degrees.
5. Place the left (right) ski on the ground and transfer the weight to it.
6. Bring the right ski around, in the same manner, to meet the left ski.
7. Repeat Steps 2–6 until facing the desired direction.

Poling

There are two different poling techniques that a cross-country skier can use, to include:

Diagonal Poling. Uses the pole opposite of the gliding ski to create additional forward motion of the skier. The skier plants and pushes with only one pole at a time.

Double Poling. Simultaneously uses both poles to propel the skis and skier forward. Used to go down gentle slopes in order to gain speed and on flats when the skier is not using the diagonal stride.

The following poling principles should be considered:

- Poles cannot push forward unless they are angled to the rear.
- The skier gets a stronger push when their arms are bent rather than straight.
- Pushing the pole back rather than down converts more of the skier's energy into forward motion at the end of a stroke.
- The skier should use their body weight, not just their arms, and pull with their core to move forward.

To diagonal pole:

1. Assume the half-sitting position.
2. Move the left ski so that it is forward of the right ski.
3. Lean forward.
4. Transfer the weight to the left ski.
5. Plant the right pole just ahead of the left ski boot (to the right of the path that the right ski will take).
6. Simultaneously push off with the left ski and push the right pole.
7. Recover by lifting the left pole.
8. Repeat the process with the other pole.

To double pole:

1. Assume the half-sitting position.
2. Keep the elbows close to the body.
3. Lean forward to round the back.
4. Plant the poles just ahead of the ski boots.
5. Contract the abdominal muscles.
6. Push forward and extend the arms back.
7. Stand up.
8. Allow the arms and poles to swing forward.
9. Prepare for the next pole plant.

Executing the Diagonal Stride

When cross-country skiing, the most frequently used technique to move forward is by executing the diagonal stride. It is called the diagonal stride because the right leg and the left pole (and vice versa) work together to move the skier forward. The diagonal stride technique makes for greater forward thrust and easy balance.

Ascending Hills

The biggest factor that affects a skier's ability to traverse up a hill is grip. Grip comes from the skier staying over their feet and pushing their skis straight down into the snow. There are two different techniques that can be used to ascend hills: herringbone and side step.

Herringbone. A technique used to climb straight up a hill on the inside edges of the skis with the tips farther apart than the tails. A skier using the herringbone technique to ascend a hill leaves an imprint that resembles the skeleton of a fish.

To use the herringbone technique to ascend a hill:

1. Place skis into a 'V' formation with the tails close together.
2. Turn the legs out.
3. Transfer the weight onto the left (right) foot.
4. Lift up the right (left) ski and move it forward.
5. Plant the left (right) pole behind the left (right) ski.
6. Repeat until reaching the top of the hill.

Side step. A technique where the skier places their skis horizontal to the hill and moves upward using short side steps. A skier uses the side step when a hill gets too steep, the snow becomes too deep, or the herringbone becomes too tiring.

To use the side step technique to ascend a hill:

1. Place the skis horizontal to the hill to be ascended.
2. Keep the body upright and centred over the skis.
3. Move the torso sideways and up the hill.
4. Plant the pole ahead of them.
5. Lift and move the ski up.
6. Dig the edge of the ski into the snow.
7. Repeat until the top of the hill is reached.

Descend a Hill

The most important factors to descending a hill safely are balance and control. A skier should never just turn their skis downhill and go—the descent must always be controlled. In other words, the skier must always be ready to slow down or stop.

When descending a hill:

1. Adopt the half-sitting position.
2. Keep the head up and look forward.
3. Move the skis so that they are just under shoulder-width apart.
4. Ensure the feet are flat on the skis.
5. Look down the slope to make sure there are no obstacles.
6. Drop the hands to thigh level.
7. Hold the pole shafts toward the back, keeping the tips off the snow.
8. Glide down the hill.
9. Slow down / stop by executing a full wedge.

SUGGESTED RESOURCES

ISBN 0-88011-652-8 Gaskill, Steven. (1998). *Fitness cross-country skiing*. Windsor, ON: Human Kinetics.

THIS PAGE INTENTIONALLY LEFT BLANK

HIKING

INTRODUCTION

Hiking is an activity of vigorous walking in the outdoors / wilderness on an unpaved trail, either on a path or navigating along an unmarked route. It offers an alternative learning environment and allows cadets to explore the outdoor surroundings. The level of challenge can be adjusted by varying the location / terrain of the hikes.

EQUIPMENT

Water Carrier. Carrying water during a hike requires a lightweight water bottle with a tight lid that is easily refillable. Choose a water bottle that can withstand the temperatures of frozen or hot liquids.

Extra Food. It is always advisable to bring extra food on a hike. Snacks such as granola bars, GORP (good old raisins and peanuts), chocolate bars, and dried fruit will provide the hiker with an energy boost. In an emergency situation they may also increase chances of survival.

Extra Clothing. Extra clothing includes an additional layer of warm clothing and a rain coat. A light down vest, sweater, or fleece jacket will provide insulation should the weather be cooler than expected, and during breaks when sweat evaporates and the body cools. Rain coats may also be used in building a shelter in an emergency situation.

Sunscreen. The skin will burn when the amount of exposure to the sun, or ultraviolet light source, exceeds the ability of the body's protective pigment to protect the skin. According to the Canadian Dermatology Association a minimum of SPF 15 with UV-A and UV-B protection should be worn.

Sunglasses. Hikers should always wear sunglasses to protect their eyes against damage from the sun's light. This is especially important in the winter, as snow blindness is a prevalent injury.

Hat. A wide-brimmed hat will protect the back of the neck, ears, and face from burning. A toque in the winter will keep the hiker's ears warm and stop the escape of heat from the head.

Insect Repellent. Mosquitoes and black flies can spread disease and have a negative impact on a hike. Wear loose-fitting clothing with closed cuffs and apply insect repellent to ward off unwanted insects.

Survival Kit. Having a survival kit is a must during any hiking trip. It should include water purification tablets, a light source, waterproof matches, a signalling device and first aid materials.

Notebook and Pencil. Having a notebook and pencil will allow cadets to keep a log of the hike, such as route details, trail condition, trail difficulty, and general observations. This will provide the cadets with beneficial information for planning other hikes. It will also provide a record of the experience.

ACTIVITY GUIDELINES

Terrain Difficulty

A-CR-CCP-951/PT-002, *Royal Canadian Army Cadets Adventure Training Safety Standards*, uses the Yosemite Decimal System (YDS) to rate trail difficulty levels. YDS has a scale from 1–5 and it rates the hardest / most technical section on a terrain / route. It also provides ratings for travel over flat terrain.

Class 1. Hiking, usually on a trail.

Class 2. Simple scrambling, crossing obstacles with the occasional use of hands, requires route-finding skills, may be backcountry dense bush.

Class 3. Angle is steep enough that hands are required for balance; scrambling on rocks using hands and feet, a rope might be carried.

Class 4. Simple climbing, often with exposure requiring a rope belay. A fall could be serious or fatal. Natural protection can usually be easily found.

Class 5. Technical rock climbing begins. Climbing involves the use of ropes, belays, and the placement of natural or artificial protection for the leader in case of a fall. An open-ended decimal extension to Class 5 exists for rating climbs within this category.

Types of Terrain

Easy Terrain. Terrain is flat and footing is secure. Forest roads, trails following streams and rolling hills are generally easy walking.

Moderate Terrain. Terrain with a trail that is mostly solid under foot with either one fairly steep hill or a series of small hills or forest floors with light underbrush.

Difficult Terrain. Any terrain in which a person ascends or descends over 150 m in 1 km. It can also consist of patches of dense forests, thick vegetation and rocky trails / root-covered trails.



Terrain for this activity shall be limited to Class 1 terrain difficulty, and to Easy or Moderate type of terrain.

HIKING TECHNIQUES

An average day of hiking will consist of periods of hiking and periods of rest. The combination of good hiking rhythm, hiking speed, and fixed rest intervals separate beginners from experienced hikers. Enthusiasm often tends to cause one to start too fast, get tired quickly, take an early rest, and start off too fast again.

Stride Rhythm and Speed

A steady hiking rhythm is generally more enjoyable as one over-exerts themselves less and keeps the physical strain at comfortable levels. Having a steady rhythm will enable the cadets to stick to a fixed schedule and lessen the strain put on the body.

Developing a Hiking Rhythm

A hiking rhythm is very personal and is developed over the course of many hikes. Here is how:

- Choose a specific stride rhythm and speed and keep to it. A good rhythm is one that allows the cadet to hike at the same intensity level for at least one hour without having to take a break.
- Adjust rhythm to terrain, weather and weight. The point where a cadet can no longer carry on a conversation indicates that they have gone beyond a comfortable rhythm.
- Make the rhythm a full-body movement where breathing and swinging of the arms happen in harmony. Uneven surfaces (eg, uphill / downhill) can make it difficult to maintain a steady rhythm.

Controlling Fatigue

The purpose of resting is to slow down the heart rate and breathing. Resting gives the body time to get rid of the lactic acids built up in muscles, and to recover from hot spots or sores.

Resting guidelines:

- Rest in regular intervals; try 10 minutes for every hour hiked (make them part of the rhythm). 10 minutes is the most effective rest duration for body recovery.
- Take off backpacks, rest in the shade, and sit down during rests.
- Use only lunch and dinner (supper) breaks as extended rest periods. During these extended breaks, allow feet to rest and dry by removing shoes, and airing out footwear.

Full Body Synchronization

Hiking rhythm is a full body affair. Just like marching, hiking requires coordinated movements where every action has a reaction. The swinging of arms provides momentum, breathing controls pace, etc. To properly control rhythm, one must first learn what body parts work in unison. To employ full body synchronization during hiking, the arms should be in motion at a natural swing, opposite the forward foot.

SUGGESTED RESOURCES

ISBN 0-7566-0946-1 Berger, K. (2005). *Backpacking & hiking*. New York, NY: DK Publishing, Inc.

ISBN 978-0-7153-2254-3 Bagshaw, C. (Ed.). (2006). *The ultimate hiking skills manual*. Cincinnati, OH: David & Charles.

THIS PAGE INTENTIONALLY LEFT BLANK

ICE SKATING

INTRODUCTION

Ice skating increases the body's flexibility and endurance with very low impact. It boosts the cardiovascular system while also improving balance and agility.

EQUIPMENT

- Helmets, and
- Ice skates.

ACTIVITY GUIDELINES

Ice skating shall be conducted at an established ice skating venue such as an ice rink.

ICE SKATING TECHNIQUES

Walking. Many rinks will have a rubber mat on which the cadets can practice walking in skates. When walking in skates, it is recommended to have the skate guards on the ice skates.

First Time on Ice. Have the first-time ice skaters move along the ice around the perimeter, so they can use the walls for support. There may be skating aids available to new ice skaters.

Practice falling. If a fall is anticipated, bend the knees and squat. When falling, hands should be quickly clenched into a fist to minimize the risk of injury from passing skaters.

Getting Up. To get up, ice skaters should get on their hands and knees and place one foot between their hands. Repeat with the other foot and lift up to the standing position.

Moving. To move, ice skaters should lean on their weak leg, and then push in a diagonal direction outwards with the strong leg, pretending they are shovelling snow behind and to the right.

Stopping. To stop, bend the knees slightly inward and then push out with one or both feet. This creates pressure on the ice causing the feet to not slide out.

SUGGESTED RESOURCES

Nil.

THIS PAGE INTENTIONALLY LEFT BLANK

INSTRUCTOR-LED DANCING

INTRODUCTION

Dancing is a social activity that encourages the development of cardiovascular endurance as well as developing strength and flexibility. The intensity of the dance can be modified to accommodate varying levels of fitness as well as ability.

EQUIPMENT

Equipment will vary depending on the selected type of dance.

ACTIVITY GUIDELINES

Dancing shall be structured, well supervised and conducted by a certified instructor or using a video that is conducted by a certified instructor.

This activity shall not be conducted as a social cadet dance.

SUGGESTED TYPES OF DANCE

- Foxtrot,
- Highland Dancing,
- Hip Hop,
- Jitterbug (Swing),
- Line Dancing,
- Salsa, and
- Waltz.

SUGGESTED RESOURCES

Jennifer Galardi. Certified Fitness Instructor. *Dance off the inches: Hip hop party*. 2007. [DVD]

Kristina Milova. Certified Fitness Instructor. *Dance off the inches: Dance it off ballroom*. 2008. [DVD]

Amy Blackburn. Certified Fitness Instructor. *Dance off the inches: Country line dance*. 2008. [DVD]

Desiree Bartlett. Certified Fitness Instructor. *Dance and be fit: Latin groove*. 2008. [DVD]

THIS PAGE INTENTIONALLY LEFT BLANK

ORIENTEERING

INTRODUCTION

By participating as an individual or as a member of an orienteering team, the cadets are given the opportunity to be active in a sport that will contribute to their living a healthy, physically active lifestyle.

EQUIPMENT

- Prepared point-to-point orienteering course,
- Prepared point-to-point orienteering course map,
- Scorecards / control cards,
- Punches
- Description sheets,
- Stopwatches,
- Whistles,
- String / twine,
- Hand-held radios,
- Table,
- Chairs, and
- Marker tape.

ACTIVITY GUIDELINES

Orienteering should be well supervised and conducted by an experienced instructor.

BACKGROUND KNOWLEDGE

Point-to-Point Orienteering

Also known as cross-country orienteering, point-to-point orienteering requires cadets to determine their own routes from one known control to the next, in a specific order. The winner is the cadet(s) who completes the course in the shortest elapsed time.

Point-to-point orienteering is the most popular of orienteering events. One reason is that it is a battle of physical stamina and quickness of mind against other participants.

Scoring Equipment

Control Markers. Found at control points on an orienteering course, control markers consist of three squares joined together to form a hollow triangular shape. Control markers are divided diagonally bottom left to top right into two triangles. The top left-hand triangle is white and the bottom right-hand triangle is an orange-red colour.

Controls may be marked with a control identifier. This identifier may be some type of number / letter or combination of both. The identifier will be written in the top left triangle of the marker and will inform the orienteer that the correct control has been located.

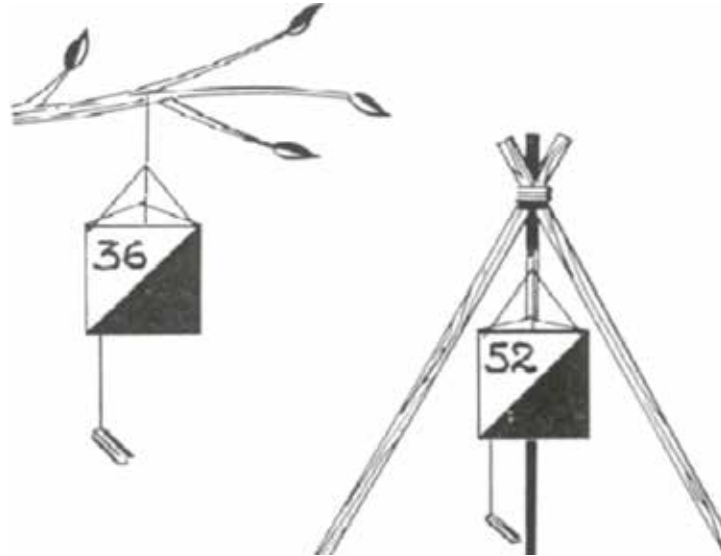

Figure F-1 Control Markers



Orienteering control markers can be created by using cardboard or plastic jugs.

Punches (Clippers). Attached to the control markers, the punch will often hang from the control marker. Each punch on an orienteering course is different and aids an orienteering competition by having the competitors use the punch on their scorecards in a specified order. Each punch has a different series of numbers or letters.

Description Sheets. The description sheets contain all the information on the competitor and their race, as well as International Orienteering Federation (IOF) symbols or written descriptions of the control points.

Scorecards. Also known as the control card, it is what the competitor uses to collect the stamps of the control markers on the course. It is handed in at the end of the race.



Orienteering [®] Control Point Card color 		CLASS <u>MI</u> COURSE <u>W</u> NO. <u>16</u> NAME <u>JOHN DOE</u> CLUB <u>NONESUCH</u> compass	FINISH <u>1:46:45</u> START <u>:18:00</u> TIME <u>1:28:45</u>	DETACH 		FOLD <u>1:28:45</u> color				
day time ck punch ck place ALL COMPETITORS MUST REPORT TO THE FINISH						COURSE <u>W</u> NAME <u>JOHN DOE</u> CLUB <u>NONESUCH</u>				
11	12	13	14	15	16	17	18	19	20	PLACE DAY CLASS <u>MI</u> NAME <u>JOHN DOE</u> CLUB <u>NONESUCH</u>
1	2	3	4	5	6	7	8	9	10	

Figure F-2 Scorecard

Orienteering Maps

The map scale is found at the bottom of the map title. The most common scales for topographical maps in Canada are 1:25 000 and 1:50 000. Common orienteering map scales are 1:5 000,

1:10 000, 1:15 000 and 1:20 000. This means that on a 1:5 000 scale map one unit on the map represents 5 000 units on real terrain. The smaller the map scale, the smaller the area is, and the more detail there is available to the competitor.

Orienteering Techniques

Folding and Holding the Map. Folding the map involves the orienteerer gently folding the map so the route is showing, running along the direction of travel, with everything else folded out of the way. It helps the orienteerer see only the information pertaining to them at the time.

Orienting the Map by Inspection. A map is oriented when north on the map is aligned with north on the terrain. The orienteerer should pick two or three objects around them and then locate them on the map. The real landmarks and the ones on the map should line up.

Thumbing Position. The orienteerers should be holding the map so their thumb is placed on the map to mark their position, adjusting their thumb position to their location each time they stop to reference the map. It saves time, helping to quickly determine where the orienteerer is, no matter how many times they have to stop and look at their map. Two steps involved in this process are ensuring the map is held properly and holding the map so it is oriented north.

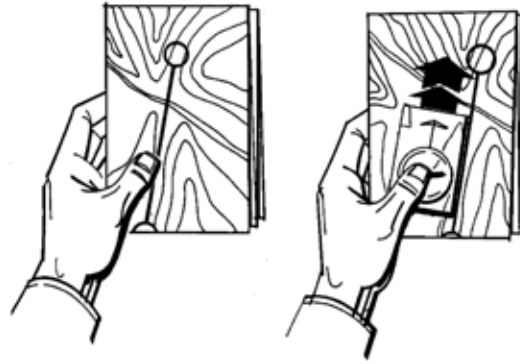

Figure F-3 Thumbing Position

Determining Distance. Orienteers should not rely on features for judging distance; they may no longer exist though they still appear on the map. The best way is step counting or pacing. This is determined by knowing how many steps or paces an individual takes in 100 m. To save time, an orienteerer should know this before beginning.

Checking Off Features. The orienteerer identifies linear features that appear before the control that will alert the orienteerer the control is nearby. As an orienteerer navigates toward the control, they have a mental checklist of the features as they come upon them.

Handrails. A handrail is a prominent linear feature that runs parallel to the direction the participant is supposed to go and leads to the control. A path between two points would be a handrail.

Catching or Collecting Features. Catching or collecting features is a technique for route evaluation that helps the orienteerer make a mental checklist of all the features they must collect or catch before they can get to their control. It is a large distinct feature situated across the line of travel on the route to, or beyond, the control. It must be a feature that is easy to recognize in the terrain, such as a large pond or power line. If it is situated in front of the control, it acts as an alert to the control. When situated beyond the control, it alerts the orienteerer that they have travelled past the point of the control.

Attack Points. Some points are located on small features that are not easily found. For this, the orienteerer might locate a larger feature as close to the control as possible. The orienteerer will look for this feature, called the attack point, run toward this point and then look for the control close by.

Attacking From Above. A control located on the side of a slope is easier for the orienteerer to find when they are coming down the slope. The orienteerer gets a better view of the terrain by looking down on it and is therefore able to find the best route to the control.

Height Assessment Versus Detouring Around. When a hill is between controls, a decision must be made by the orienteerer whether to go over or around. It must be decided if it is easier for the individual to climb the slope and possibly expend more energy, or to go around, which may be a longer route but easier to run due to level ground. The elevation of the slope may be a deciding factor.

Long Easy Route Versus Short Tough Route. A competitor must take into consideration the distance to travel both routes, and how quickly they will be able to travel over the terrain. This will be dependent on the vegetation that will be encountered.

Route Evaluation Techniques Using The CART Acronym

A systematic approach to map reading, represented by an acronym meaning:

- **Control.** What control is the orienteerer trying to find?

- **Attack point.** What is an attack point that is easy to identify? It should be close to and before the marker, distinct, prominent and easy to reach.
- **Route choice.** What is the best route to the attack point? This will depend on the nature of the terrain, the distance to be covered and the skills and abilities of the orienteerer.
- **Technique.** What is the best technique to use on each leg of the competition? This will depend on the terrain, distance and the individual orienteerer, but must be decided before starting the leg.



This may seem overwhelming for the novice orienteerer, but point out to the cadets that they would naturally use some of these techniques without realizing it.

Start and Finish Routine

At the start of the event, the cadets will move to the starting line and wait for a blast from the instructor's whistle. At this point, a departure time must be written down on the recording sheet (as illustrated in Figure B6-5).

Usually at the beginning of the event there will be an area called the starting grid. This gives the participants a three-minute preparation period prior to starting the event.

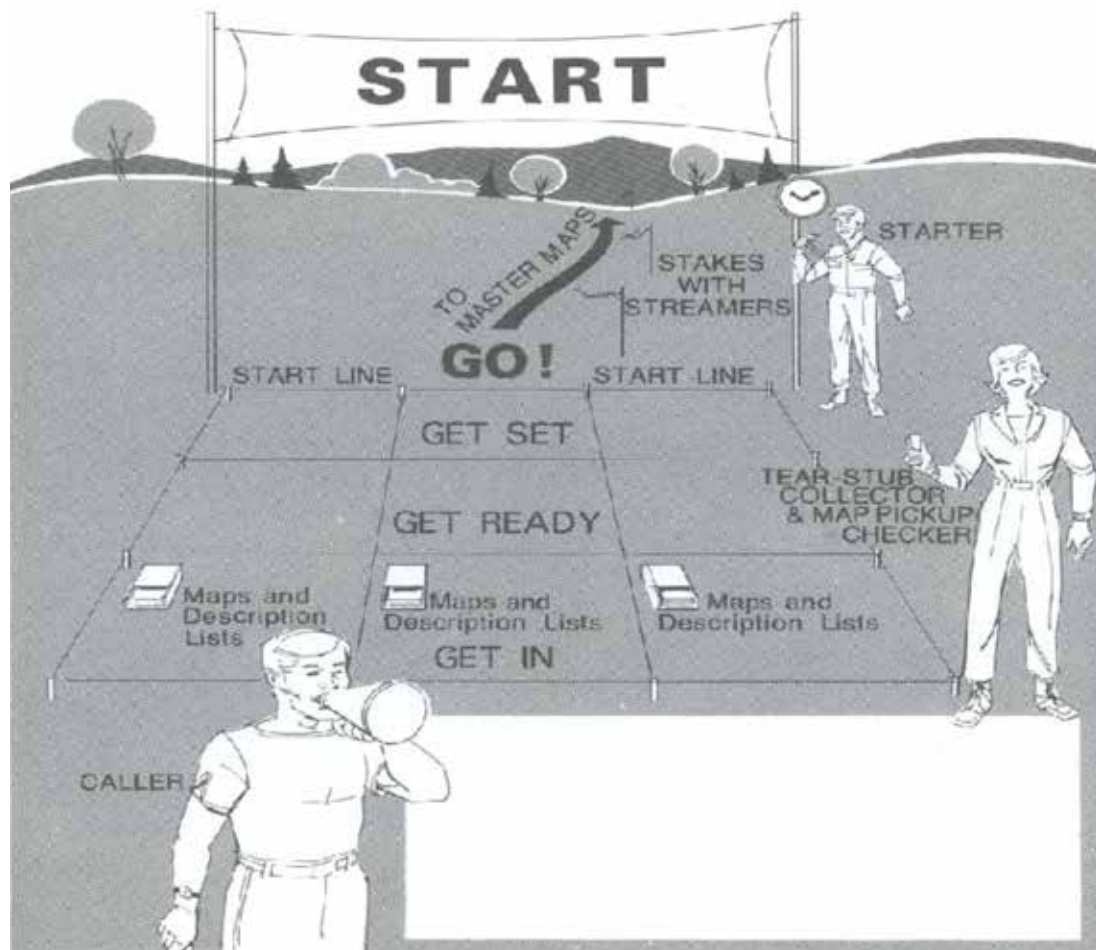

Figure F-4 Starting Grid

Three minutes before the cadet is to start, they are called to the “Get In” row of the starting grid. A minute later, upon hearing a whistle, the cadets move forward to the “Get Ready” row, where they review a copy of the description list and the map (if it is not a pre-marked map). One minute before the start, the cadets move to the “Get Set” row, where pre-marked maps are distributed, but they are not allowed to be looked at until they hear the “Go” whistle.

On the zero-minute, there will be a “Go” whistle, signaling the cadets to begin. It is at this point that the departure time is recorded on the recorder’s sheet.

RECORDING SHEET								
EVENT _____		PLACE _____			DATE _____			
NAME	No.	Team	Class	Start Time	Finish Time	Time Used	Controls Missed	Position

Figure F-5 Recording Sheet



Cadets are to be given pre-marked maps at this level.

Course Layout

A point-to-point type of orienteering (also known as cross-country or free orienteering) event will be conducted to allow the cadets to assist with orienteering. This type of orienteering is considered the ultimate challenge for orienteers. The course and markers are placed in a circular configuration where every competitor must visit the same control in the same order in the shortest amount of time. This challenges the competitor to choose the best possible route and maintain stamina.

The layout of the course is based on the competitor level of experience and usually consists of 8–12 controls situated in varying degrees of difficulty and distance.

RULES AND REGULATIONS

Orienteering meets expect competitors to follow basic rules and regulations that also deal with ethics and safety when participating in a point-to-point orienteering activity.

Technical Rules

- Participants shall not damage, remove or hide any controls during an event.
- Participants shall only use the map provided by the organizer plus a compass during an event.
- Participants shall visit the controls in the specified order in a point-to-point orienteering event.
- Participants must not enter / cross areas marked on the map as uncrossable or out of bounds.

- Participants shall not damage property such as fences or equipment.
- Participants shall not enter / cross gardens, newly-planted fields or those with growing crops.

Safety Rules

- Cadets should wear clothing that covers the full body.
- Cadets must carry a whistle during the event.
- Cadets should be familiar with the international distress signal (three blasts on a whistle).
- Cadets must report to the finish official and hand in their map and control card whether or not they complete the course.
- Cadets must aid injured persons they encounter during the event.
- Cadets must observe traffic rules when crossing roads or railways.
- Organizers shall provide safety bearing information.

Ethical Rules

- Cadets should not follow others.
- Cadets should not discuss the course with others while on the course.
- Cadets who ask for assistance should be shown their location on the map and then report it to an official at the finish.
- Cadets who have finished their course should not divulge information about the course, map or terrain to others who have not started.
- Cadets shall respect the land and environment.

SCORING AND TIMING

The finish line is where all scoring and timings will take place. It is important that the finish area allows officials to properly complete their tasks. Officials will have to record, calculate times and verify each orienteerer visited each control on the course.

When competitors finish, officials are responsible for four main tasks:

1. collecting control cards in order of finish,
2. calculating and recording finish times,
3. verifying control card punch patterns, and
4. displaying results.

SUGGESTED RESOURCES

ISBN 0-02-029265-1 Kjellstrom, B. (1994). *Be Expert With Map & Compass: The Complete Orienteering Handbook*. New York: Hungry Minds, Inc.

Stott, W. (1987). *Armchair Orienteering II: A Practical Guide to Route Planning*. Winnipeg: Manitoba Orienteering Association.

THIS PAGE INTENTIONALLY LEFT BLANK

ROLLERBLADING

INTRODUCTION

Rollerblading increases the body's flexibility and endurance with very low impact. It boosts the cardiovascular system while also improving balance and agility.

EQUIPMENT

- Rollerblades,
- Knee pads, elbow pads, wrist guards, and
- Helmet.

ACTIVITY GUIDELINES

Rollerblading shall be conducted on smooth, paved surfaces such as established paths.

ROLLERBLADING TECHNIQUES

Start on Carpet or Grass. Have new rollerbladers start on carpet or grass because the wheels will not roll. This allows them to get used to the increased height and its affect on their centre of balance.

Falling and Getting Up. Have new rollerbladers fall forward, sliding on their knee pads and wrist guards. If they feel like falling backwards, have them grab their knees. This will pull them forward, so they will either stay upright, or fall forward. Make sure the wrist guards impact at a sliding angle—not straight down, as this may cause a jarring impact that can cause injury.

Practice Moving. Have new rollerbladers get a feel for how to move. Have them take a few steps. Also have them move one foot forward while gradually increasing pressure on that foot until there is almost no pressure on the other. Have them do the same with the other foot until they are able to "glide" back and forth a few times.

Move to a Hard Surface. Concrete is ideal because the wheels will find friction easily while allowing movement more freely than carpet. Asphalt is not recommended for beginners because its smoother surface will force the wheels to roll more easily.

Experiment. Experiment. Practice turning, balancing on one skate, and walking.

Braking. Just like driving riding a bike, or even running, have the cadets anticipate where they want to stop. To brake, move one foot forward and bend the knee slightly and apply pressure on the heel.

SUGGESTED RESOURCES

Nil.

THIS PAGE INTENTIONALLY LEFT BLANK

RUNNING

INTRODUCTION

Running is one of the most common activities to develop cardiovascular fitness. Running may be done at a variety of speeds, which enables the cadets to vary the intensity of the training session.

EQUIPMENT

Running shoes.

ACTIVITY GUIDELINES

Running shall be conducted in a dry, safe environment or indoors on an established running track.

RUNNING TECHNIQUES

There are six main techniques for running, used to cover the distance at maximum speed with minimum effort; they are:

Poise of the Head and Balance of the Body. The poise of the head controls the balance of the body. The head should be held in alignment with the trunk, the neck muscles relaxed, and eyes looking ahead. The chest and hips should be kept square to the front. There should be no bending at the hips, either forward or backward. A conscious effort to maintain alignment may be necessary.

Leg Action. The legs are the driving forces behind the body, as well as the supporting power. When running, the toes should be pointed straight ahead, the knees should be lifted forward, and hip rolling should be avoided. The lower leg should be kept completely relaxed as it swings forward; the foot just clearing the ground. Do not use a bouncing or bounding stride in which the body weight is shifted upwards unnecessarily.

Arm Action. While running, the arms act as speed and balance controllers. The most efficient direction for the swing of the arms is forward and inwards, partly following the direction of the body and partly in towards the centre of gravity of the body. Shoulder movement should be reduced to a minimum. Shoulder rolling and shoulder shrugging should be avoided. Avoid contracting the muscles of the neck. Each person will find the most comfortable height for carrying the hands.

Limb Coordination and Rhythm. These come automatically to maintain body balance and ensure smooth movement. A change or break of rhythm leads to less efficiency and greater fatigue.

Relaxation. A certain degree of relaxation comes naturally, but increasing relaxation of the upper body during running may take practice and concentration. When increases in relaxation occur during running, more efficient motion will take place, resulting in distance being covered in less time.

Breathing. Breathing in and out should be done through both the nose and the mouth. Inhale mostly through the nose and exhale mostly through the mouth. Breathing should follow an automatic rhythmical rate set by limb movement.

Duration of a Training Session

All running activities should begin with a warm-up. The main part of a running training session may be a straight distance run, around a track, on a road, or cross-country. A minimum of 15 and preferably 20 minutes of sustained running is required to increase cardiovascular fitness. Running for time or distance will aid in increasing fitness levels. The cool-down should include slowing the pace of the run and flexibility exercises. It is essential that the heart rate is brought below 100 beats per minute before the cool-down is considered complete.

Alternating Terrain

Running on alternating terrain may be conducted on a course laid out along roads, across fields, over hills, through woods, or on any irregular ground. Running on alternating terrain provides a break in routine. Many runners prefer to follow cross-country trails rather than run on tracks or roads.

SUGGESTED RESOURCES

ISBN 0-684-85455-4 Bingham, John. (1999). *The courage to start: A guide to running for your life*. New York, NY: Fireside.

SKIPPING ROPE

INTRODUCTION

Skipping will help improve cardio-respiratory (heart and lungs) fitness, flexibility and co-ordination. As a high-impact exercise, skipping is great for building bones and a good exercise to lose weight and define muscle mass.

EQUIPMENT

- Running shoes, and
- Skipping rope.

ACTIVITY GUIDELINES

To help prevent injury, running shoes shall be worn during skipping rope exercises.

Skipping to music, combining different foot combinations and also adding circuit exercises helps maintain interest while skipping.

SKIPPING ROPE TECHNIQUES

Running on the Spot. Run on the spot with the rope passing underneath between each step.

Side Rope Swings. Push the skipping rope to the side by moving both hands to one side. On the next skip, bring the rope back to the middle so it goes around the body. This movement is great for transitioning from one combination to another and can be used to relieve arm tension.

High knees. After each skip, bring the knee up to the chest. Attempt to bring each knee up as high as possible to activate the hip flexors and extenders and the abdominal musculature.

Heel to Toe. Alternate landing on the toes of your feet and on the heels of your feet. Be careful when landing on the heel—it should be a soft landing.

Split Jumps. On each skip, alternate one foot forward and one foot back. Land on the toes of each foot.

Criss-Cross. The feet cross and uncross each jump. Alternate between crossing the left foot with the right foot and the right foot with the left foot. Use different combinations of each cross-over. This improves your coordination and focus.



Figure I-1 Criss-Cross Pattern

Double Jumps. Jump high enough and swing the rope fast enough so the rope goes around twice for each jump.

One Foot Jumps. Skip on one foot instead of two. This version works the calf muscles. The number of jumps per foot (double jumps) or the way you land on each foot (heel to toe) can be varied to create and maintain interest.

One + Combo. This is a combination of the one foot jumps and the side rope swing. Do one one-foot-jump on each foot, then do a side swing. Do two one-foot-jumps on each foot then a side swing. Next are three one-foot-jumps and a side swing. Continue progressively increasing the number of jumps.

Two-By-Two Combo. Jump twice on the right foot and twice on the left foot; continue alternating. This combo can be increased to a three-by-three combo or a five-by-five combo.



Figure I-2 Split Jumps Pattern

SUGGESTED RESOURCES

Heart and Stroke Foundation of Canada. (2011). *Skipping skills posters*. Retrieved November 10, 2011 from http://www.jumpropeforheart.ca/Content/Files/SkillsPosters_2011_E.pdf

SHOWSHOEING

INTRODUCTION

Snowshoeing is an aerobic activity that involves walking through the snow and is an easy skill to learn. It tones your entire body while providing an excellent cardiovascular workout; it strengthens leg and heart muscles and improves delivery of oxygen to muscles. People can immediately walk on snowshoes even if they have never worn them before. Snowshoeing helps improve the cardiovascular and muscular strength components of fitness.

EQUIPMENT

Snowshoes. The chart below is a rough guide to follow when in a standard condition of wet powder snow.

Snowshoe Size	Carrying Capacity
20 cm by 56 cm (8 inch by 22 inch)	68 kg (150 lbs)
20 cm by 63 cm (8 inch by 25 inch)	90 kg (200 lbs)
22 cm by 43 cm (9 inch by 34 inch)	113 kg (250 lbs)
24 cm by 86 cm (9.5 inch by 36 inch)	136 kg (300 lbs)

The smaller the snowshoe, the better it will be for climbing over blow downs (fallen trees and bushes) and through brush. The larger the snowshoe, the better flotation on top of snow.

Bindings. The binding attaches the foot to the snowshoe securely, preventing the heel from sliding from side to side, even when travelling across a slope. Bindings most often fit a wide range of boot sizes. In any category of snowshoe, the binding should be made of hardy, flexible rubberized nylon straps, with buckles that do not loosen or freeze and are easily manipulated even when wearing mittens. The bindings must not be fastened too tightly where circulation may be cut off, as the chances of frostbite will increase.

Poles. Telescoping trekking poles are the most versatile choice for snowshoeing. These poles provide better balance and reduce the amount of stress on the knees, shoulders and back. They absorb some of the impact the body would otherwise absorb. The poles, rather than the body, absorb shock, reduce arm and leg fatigue and improve endurance. While snowshoeing, they help a person keep balance while climbing inclines or when backing out of an area in deep snow. Although trekking poles are generally not required when snowshoeing, they are a helpful accessory.

ACTIVITY GUIDELINES

Snowshoeing shall be limited to new fallen snow, powder snow, and wind-packed snow. Refer to the Skiing section for more information on types of snow. The same types of snow as skiing should be avoided when snowshoeing.

SNOWSHOEING TECHNIQUES

Snowshoeing is a very easy skill to learn. People can immediately walk on snowshoes even if they have never worn them before. However, there are techniques that will greatly improve these abilities while snowshoeing over snow-covered terrain.

Striding

To conserve energy when snowshoeing on soft snow, lift the snowshoe to clear the snow and thrust forward to complete each pace. The rest step allows for momentary pauses between steps. With practice, one can adjust the length of the pause to the state of fatigue. As one steps forward, thrust the front snowshoe out and let it plop down, or stamp it firmly into place. Straighten and lock the rear knee joint so the tendons and cartilage are holding weight and pause and relax the thigh muscles, using the poles to maintain balance. Bring the rear leg ahead, thrust the snowshoe out, place it, lock what is now the rear leg, relax momentarily and repeat. The effect is to rest the legs during the time they are actually working hard. A couple of seconds of work with a couple of seconds of rest make it possible to keep going steadily without long stops.

Executing Kick Turns

Kick turns are performed when a change in direction is required. It is commonly used in an enclosed area along the trail. The steps in performing a kick turn are:

1. Lift one leg and swing it back, and then kick it forward and upward.
2. At the top of the kick, just as the tail of the snowshoe clears the snow, turn the foot 180 degrees.
3. Lower and plant the foot in the snow, with the front of the foot facing to the rear.
4. Shift the body weight to the foot facing 180 degrees to the rear and then lift the other foot.
5. Bring the foot over the trailing edge of the planted snowshoe and face the new direction.

Crossing Obstacles

Obstacles such as fallen trees, logs, tree stumps, ditches and small streams can be stepped over. Care must be taken not to place too much strain on the snowshoe ends by bridging a gap, since the frame may break. In shallow snow, there is a danger of catching and tearing the webbing on tree stumps or snags that are only slightly covered. Never bridge two obstacles together with the snowshoes. When jumping over obstacles do not let the tails of the snowshoes fall downward. If the tail of the snowshoe is vertical upon landing, it will strike the snow first and may result in a fall. When possible, find an alternate route around the obstacle.

Ascending Hills

The method chosen to walk uphill will depend on the angle of the incline and the condition of the snow. The following techniques can be used when navigating uphill.

Step kick. When going straight up a hill, this is the most efficient method on firm or hard packed snow where traction is not a concern. Kick the toe of the snowshoe in the snow ensuring that it is firmly planted before shifting weight to the snowshoe.

Edging. Used when walking up a steep slope. Performed by kicking the snowshoe sideways into the slope, or moving the boot heel as far toward the uphill side of the slope as possible. Stamp the snowshoe down, forcing the outside edge of the snowshoe into the slope. When edging, the body will be perpendicular to the slope.

Switchbacking. Used to travel a slope that is fairly steep and is covered in deep powder snow. Ascend the hill by walking across the slope at an angle that is comfortable and not steep enough to allow the snowshoes to slip. To turn back (switchback) to the right, firmly stamp the left snowshoe in the snow and make sure it will hold. Shift the weight to the left foot, face the slope, and then swing the right snowshoe around to point it in the direction of the next switchback and firmly stamp it into the snow. Ensure that the tail of the right snowshoe is not placed on the left snowshoe. Stamp the right web into the snow and gently shift the body weight to step on it. To make a left turn, reverse the procedure.

Descending Hills

The method that is chosen to walk downhill will depend on the angle of the incline and the condition of the snow. The same techniques for ascending hills are used to descend. When descending a hill a person should follow the following guidelines:

- Do not lean forward by bending at the waist. This is a normal tendency for beginners and will increase the chance of falling forward.
- Avoid leaning back on the snowshoes, as if digging in the heels. This will increase the chance of the snowshoes sliding out from under the snowshoer.
- To assume a safe posture, stand straight up, balance the body straight over the foot, slightly bend the knees to compensate for changes, and then relax.

Breaking Snow

In loose snow, the trailbreaker may have several extra pounds of snow on the snowshoes. The snow falls on top of the webbing when walking and sinking in deep snow. This extra weight will exhaust the trailbreaker at a faster rate than the followers. When the trailbreaker feels they can no longer move forward at a progressive pace, they should step to the side and drop to the rear as the rest of the party moves past.

SUGGESTED RESOURCES

Edwards, S. & McKenzie, M. (1995). *Outdoor pursuits series: Snowshoeing*. ISBN 0-87322-767-0. Windsor, ON: Human Kinetics Inc.

Savignano, P. (2001). *Basic essentials: Snowshoeing*. ISBN 0-7627-0629-5. Guilford, CT: The Globe Pequot Press.

THIS PAGE INTENTIONALLY LEFT BLANK

SWIMMING

INTRODUCTION

Swimming is a fun activity that can include doing laps, playing games and aqua aerobics.

EQUIPMENT

The equipment required will depend on the selected swimming activity.

ACTIVITY GUIDELINES

This activity shall be conducted IAW A-CR-CCP-030/PT-001, *Water Safety Orders*, Chapter 6.

SWIMMING GAMES / ACTIVITIES

Whirlpool. Have the cadets stand in a circle holding hands, in the shallow end of the pool. Have the group start walking in a clockwise direction, moving faster and faster creating a whirlpool. Once the group has gained momentum, count to three and have the cadets let go. The whirlpool will spin the cadets outwards.

Sharks and Minnows. This is a game of tag, where one cadet is designated the “shark” and the rest “minnows”. The minnows must constantly move in the water trying to avoid being tagged by the shark.

Aqua Aerobics. Aqua aerobics is an excellent activity for those who have suffered injury or are beginning cardiovascular fitness training as it causes little stress on the joints. If it is selected, it shall be conducted by a certified instructor or using a video that is conducted by a certified instructor.

SUGGESTED RESOURCES

Karen Westfall, Aqua Fitness Expert. *Aqua Combo Splash*. N.D. [DVD]

Katz, Jane. (2003). *Your water workout: No-impact aerobic and strength training from yoga, Pilates, tai chi and more*. ISBN 978-0767914826. USA: Broadway Books.

Kidspot. (2011). *Pool water*. Retrieved November 28, 2011, from www.kidspot.com.au/kids-activities-and-games/Pool-Water+8.htm

THIS PAGE INTENTIONALLY LEFT BLANK

MUSCULAR STRENGTH EXERCISES USING THE BODY, BALANCE BALLS, RESISTANCE BANDS, AND WEIGHTED BALLS AND BARS

INTRODUCTION

Well-structured resistance training can provide youth many health benefits, such as preventing injuries, increasing strength / endurance / power, and assisting to build strong, healthy bones.

EQUIPMENT

- One balance ball per cadet, and/or
- Resistance bands / weighted balls / weighted bars (various resistance levels / weights), and
- One mat per cadet.

ACTIVITY GUIDELINES

Activities using equipment shall be conducted by a F&SI trained in its use or a certified trainer.

Choose a training area that has adequate space (eg, balance balls may roll around very easily).

Conduct each new exercise using the following method (If the exercises are used as part of a circuit, introduce them all before the cadets start the circuit):

1. Demonstrate the complete exercise.
2. Demonstrate the starting position and have the cadets adopt the starting position.
3. Demonstrate the subsequent movements and have the cadets complete each movement.
4. Demonstrate the complete exercise and have the cadets complete the entire exercise.

Safety

To avoid injury and maximize the effectiveness of the exercise, have the cadets complete the movements in a slow, deliberate, and controlled manner. Have them use lightweight equipment.

Ensure the balance balls are sized to the cadets. Cadets should be able to sit on the ball with their feet touching the ground and legs at a 90-degree angle or slightly more.

Instruct the cadets to maintain a good grip on the equipment and to not let go of resistance bands during the exercises as they might snap back and cause injury.

EXAMPLES OF RESISTANCE EXERCISES USING THE BODY

Push Up. Lay face down and place the hands under or slightly wider than the shoulders with fingers stretched out. Straighten the legs with feet slightly apart and tuck the toes under the shins. Push up with the arms until they are straight, keeping the legs and back aligned. Lower the body using the arms until the elbows bend at a 90-degree angle and the upper arms are parallel to the floor.



Figure L-1 Push Up

Curl Up. Lay on the floor with the back and head down. Place the feet flat and legs slightly apart. Feet should be extended as far as possible from the buttocks while still allowing feet to remain flat on the floor. Rest the palms on the mat with the arms straight, parallel to the trunk, and fingers stretched out. Curl up slowly, keeping the heels in contact with the floor.



Figure L-2 Curl Up

Lunge. Stand with one leg forward and one backward. Slowly bend the knees, lowering into a lunge while keeping the front knee and back knee at 90-degree angles. Keeping the weight in the heels, push back up to starting position.



Figure L-3 Lunge

Squat. Stand with feet shoulder-width apart. Push the hips back while bending at the knees, as if sitting into a low chair. Push through the heels and extend the knees to return to the start position.



Figure L-4 Squat

Bridge. Lay on the floor with hands by the sides, knees bent and feet flat on the floor. Keeping the head and shoulders on the floor, raise the hips up to create a straight line from the knees to the shoulders. Hold for 20–30 seconds.



Figure L-5 Bridge

SUGGESTED RESOURCES

ISBN 978-0-7360-6675-4 Corbin, C., & Lindsey, R. (2007). Fitness for life: Updated fifth edition. Windsor, ON: Human Kinetics.

EXAMPLES OF BALANCE BALL EXERCISES

Ball Crunch. Lie on top of the ball with the lower back resting on the ball, fingers behind the ears. Pull the stomach in and curl the head and torso up towards the knees. Lower to the start position.



Figure L-6 Ball Crunch

Ball Plank. Place the forearms on the ball and raise the chest, so the elbows are under the shoulders. Extend the legs behind on the floor. The body should form a straight line from ankles to head. Pull the shoulder blades back and down, and brace the abs. Hold this position for 30 to 60 seconds.



Figure L-7 Ball Plank

Ball Push Up. Begin with the hands set slightly wider than and in line with your shoulders, and shins resting on the ball, forming a straight line with the body from shoulder to ankles. Lower the upper body towards the floor by bending the elbows. Push the upper body back to the original position by straightening the elbows. An alternate for this exercise is to complete the push up with the hands on the ball, placed under the shoulders and pushing up.



Figure L-8 Ball Push-Up

Ball Jackknife. Begin with the hands set slightly wider than and in line with your shoulders, and shins resting on the ball, forming a straight line with the body from shoulder to ankles. Roll the ball towards the chest by raising the hips and slightly rounding the back while pulling the ball forward with the feet. Pause, and then return the ball to the starting position by rolling it backwards.



Figure L-9 Ball Jackknife

Ball Hand-to-Feet Pass. Begin lying on the back with the ball held up with the hands above the chest. Raise the legs towards the ball with knees slightly bent and pass the ball from the hands to the feet. Move the ball towards the floor by lowering the legs. Raise the ball up towards the hands and pass the ball from the hands to the feet.

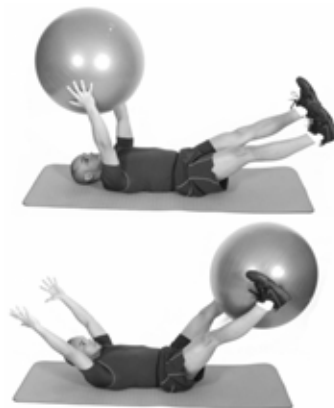

Figure L-10 Ball Hand-to-Feet Pass

SUGGESTED RESOURCES

Mari Winsor, Certified Pilates instructor. *Winsor Pilates ball workout*. 2005. [DVD]

Allie DelRio Pointer, Firm Master Instructor. *The Firm: Core stability ball*. 2006. [DVD]

ISBN 9781856486637 Flett, M. (2003). *Swiss ball: For strength, tone, and posture*. New York, NY: Sterling Publishing Limited.

EXAMPLES OF RESISTANCE BAND EXERCISES

Bicep Curl. Stand on the band with knees bent, holding the handles (or the ends) with the palms facing forward. While keeping the abs in, bend the arms bringing the palms toward the shoulders. Widen the stance on the band to add tension to the band. Return to start and repeat.



Figure L-11 Bicep Curl

Triceps Extension. Hold the band in both hands at shoulder level with the arms bent in front of the chest. Keeping the left hand stationary, straighten the right arm out to the side. Return to start. Repeat for the left arm.



Figure L-12 Triceps Extension

Rear Delt Fly. Hold the band in both hands, a few inches apart, with arms straight out in front at shoulder level. Squeeze the shoulder blades together and pull the band so that the arms are out to the sides like an airplane. Return to the start and repeat, keeping tension on the band the entire time.



Figure L-13 Rear Delt Fly

Overhead Press. Place both feet on the band and grasp handles / ends, bring the hands up just over shoulders with elbows bent and palms facing towards the ears. Press arms up over the head and then lower.

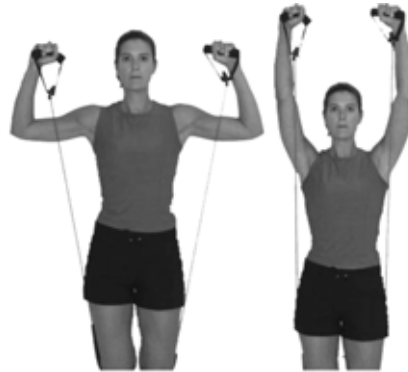

Figure L-14 Overhead Press

Squats. Stand on the band with feet shoulder-width apart, keep tension on the band by holding the ends of the band in each hand with the arms bent halfway up. Lower into a squat (as if sitting in a chair) keeping the knees behind toes. Pull on the band to add tension. Return to the start and repeat.



Figure L-15 Squats

SUGGESTED RESOURCES

Paul Katami, Certified Fitness Instructor. *Paul Katami's A.S.A.P. Band Camp*. 2009. [DVD]

Alison Davis-McLain, Certified Group Fitness Instructor. *The Firm: Pilates Band*. 2006. [DVD]

ISBN 9781856487245 James, M. (2004). *Resistance band workout: A simple way to tone and strengthen your muscles*. New York, NY: PRC Publishing Limited.

EXAMPLES OF RESISTANCE EXERCISES USING WEIGHTED BALLS

Triceps Extension. Stand with feet spread shoulder width apart (or sit on a chair / balance ball). Hold the weighted ball over the head with the elbows tucked in near the ears. Bend the elbows backward to lower the weighted ball behind the head. Raise the ball to the original position.

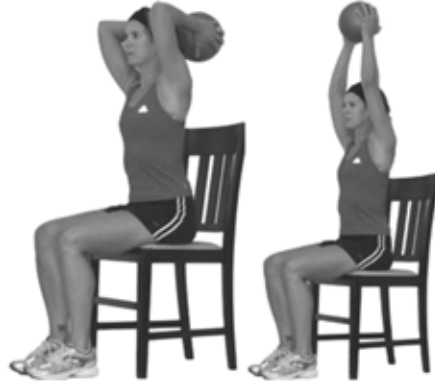

Figure L-16 Triceps Extension

Figure of Eight. Hold the weighted ball with the arms extended over the right shoulder and the knees bent. In one continuous motion bring the weighted ball down in front as if chopping wood, finishing when the ball is toward the left foot. Raise the weighted ball straight up over the left shoulder. Bring the weighted ball down in front using the same motion as the first part of the movement, finishing when the ball is toward the right foot. Repeat in a continuous figure of eight motion.



Figure L-17 Figure of Eight

Weighted Ball Obliques. Lay on the back with the knees bent up towards the chest. Place a weighted ball between the knees and hold in place with the knees. Slowly rotate the legs to one side. Return the legs to the centre. Repeat the movement for the other side.



Figure L-18 Weighted Ball Obliques

Reverse Curls. Lay on the back with the knees bent and feet parallel to the floor. Place a weighted ball between the knees and hold in place with the knees. Slowly raise the ball towards the chest. Slowly return the feet to the original position.



Figure L-19 Reverse Curls

Weighted Ball Twist. Sit on the floor with knees bent and feet placed flat on the floor. Hold a weighted ball straight in front with the arms in line with the shoulders. Keeping the back straight, lean back slightly. Slowly and in a controlled form, pull the abdominal muscles in and rotate the torso to the side. Return to the centre. Repeat the movement for the other side.



Figure L-20 Weighted Ball Twist

SUGGESTED RESOURCES

Patrick Goudeau, National Academy of Sport Medicine (NASM) certified trainer. Patrick Goudeau's Play Ball. 2008. [DVD]

ISBN 9781585189007 Mediate, P. & Faigenbaum, A. (2004). Medicine ball for all training handbook. Monterey, CA : Healthy Learning.

EXAMPLES OF RESISTANCE EXERCISES USING WEIGHED BARS

Bicep Curl. Begin by grasping the weighted bar with an underhand grip about shoulder width apart. Begin with the bar resting at the thighs with the elbows slightly in front of the body. Bend the elbows to bring the bar up towards the shoulders without letting the elbows move behind the body. Return to the starting position.



Figure L-21 Bicep Curl

Shoulder Hold Squat. With feet about hip distance apart, bring the weighted up and over the head to and rest it on the back of the shoulders. Push the hips back while bending at the knees, as if sitting into a low chair. Push through the heels and extend the knees to return to the start position. Be sure not to pull on the bar during the squat, but rest the hands lightly on the underside of the bar during the movement.



Figure L-22 Shoulder Hold Squat

Bent Over Row (Overhand). Begin with the feet hip-width apart (or wider), grasping the weighted bar with an overhand grip. Tilt at the hips and let the bar hang at the knees. Hands should be just outside the knees to begin. Bend the elbows and pull back to bring the bar in towards the crease of the hip. Elbows should be tucked in close to the sides. Extend the elbows to return to the starting position.



Figure L-23 Bent Over Row (Overhand)

Two Arm Chest Press. Lay on the floor with knees bent so both feet are on the floor. Grasp the weighted bar in an overhand grip with hands slightly wider than shoulder width. Ensure the weighted bar begins directly over the chest with arms straight. Bend the elbows out to the sides to bring the bar towards the chest. Extend elbows to return to starting position.



Figure L-24 Two Arm Chest Press

Reverse Abdominal Curl. Lay on the floor with knees bent so both feet are on the floor. Place the bar underneath the knees and lift feet off the floor. Curl the bottom away from the floor to execute the reverse curl. Return to the starting position.



Figure L-25 Reverse Abdominal Curl

SUGGESTED RESOURCES

Rob Glick, Bachelor of Science in Exercise Science. Body bar: Deep definition. 2003. [DVD]

ISBN 978-1-4027-3190-7 Cook, Greg & d'Almeida-Cook, F. (2006). Body bar: 133 moves for full body fitness. New York, NY: Sterling Publishing Co.

THIS PAGE INTENTIONALLY LEFT BLANK

PILATES

INTRODUCTION

Pilates was created by Joseph H. Pilates in the 1920s. This type of exercise focuses on strengthening the core muscles. This muscle-strengthening activity is also helpful for managing weight as it strengthens and lengthens core muscles without adding bulk. Pilates helps improve the muscular strength and muscular flexibility components of fitness.

EQUIPMENT

One mat per cadet.

ACTIVITY GUIDELINES

Pilates shall be conducted by a certified instructor or using a video that is conducted by a certified instructor.

SUGGESTED RESOURCES

Ellen Barret, Certified Pilates and fitness instructor. *Crunch: Pick your spot Pilates*. 2002. [DVD]

Kristin McGee, Pilates master instructor. *Pilates for beginners with Kristin McGee*. 2009. [DVD]

THIS PAGE INTENTIONALLY LEFT BLANK

STRETCHING

INTRODUCTION

Stretching involves performing exercises to lengthen the muscles and improve flexibility. There are three types of stretching:

- **Static Stretching.** Stretching without movement. An example would be a shoulder stretch done by pulling the arm across the body and holding the arm still for a minimum of 10 seconds.
- **Proprioceptive Neuromuscular Facilitation.** Contracting the muscles before statically stretching them, eg. using a towel to help with a calf stretch and contracting the calf by pushing the toes against the towel; followed by pulling on the towel to stretch the calf muscle.
- **Ballistic Stretching.** Using bobbing or bouncing causing the muscles to stretch. This type of stretching is not recommended for beginners as it can lead to injury if done improperly.

EQUIPMENT

One mat per cadet.

ACTIVITY GUIDELINES

Have the cadets wear loose clothing that allows free, unrestricted movement. Have them participate in a general warm-up consisting of light cardiovascular activities that will help raise the heart rate and warm the muscles prior to doing any stretches.

STRETCHES

Sample stretches are located at Attachment B of EO MX04.01 (Participate in 60 minutes of MVPA and Track Participation in Physical Activities). The stretches shall be conducted as static stretches. At no time shall any be conducted as ballistic stretches.

SUGGESTED RESOURCES

ISBN 0-936070-22-6 Anderson, B. (2000). *Stretching: 20th anniversary* (Rev. ed.). Bolinas, CA: Shelter Publications, Inc.

Bob Anderson, Graduate of California State University in Physical Education. *Stretching with Bob Anderson*. 1987. [DVD]

THIS PAGE INTENTIONALLY LEFT BLANK

TAI CHI

INTRODUCTION

In China it is believed that tai chi can delay aging and prolong life, increase flexibility and strengthen muscles and tendons. Tai chi is a centuries-old Chinese martial art that descends from qigong, an ancient Chinese discipline that has its roots in traditional Chinese medicine. It involves a series of slow, meditative body movements that were originally designed for self-defense and to promote inner peace and calm. Tai chi helps improve the muscular flexibility component of fitness.

EQUIPMENT

One mat per cadet.

ACTIVITY GUIDELINES

Tai Chi shall be conducted by a certified instructor or using a video that is conducted by a certified instructor.

Have the cadets wear clothing that allows free, unrestricted movement.

Keep training at a beginner level to allow all cadets to participate safely.

SUGGESTED RESOURCES

Samuel Barnes. Certified Tai Chi Instructor. *Element: Tai Chi for Beginners*. 2008. [DVD]

THIS PAGE INTENTIONALLY LEFT BLANK

YOGA

INTRODUCTION

Yoga is a popular activity that includes attention to flexibility, relaxation, breathing, and strengthening. Through various yoga poses flexibility and range of motion can be improved. Yoga helps improve the muscular flexibility and muscular strength components of fitness.

EQUIPMENT

One yoga mat per cadet.

ACTIVITY GUIDELINES

Yoga shall be conducted by a certified instructor or using a video that is conducted by a certified instructor.

Have the cadets wear clothing that allows free, unrestricted movement.

Keep training at a beginner level to allow all cadets to participate safely.

SUGGESTED RESOURCES

Colleen Saidman & Rodney Yee. Certified Yoga Instructors. *Rodney Yee's Yoga for Beginners*. 2009. [DVD].

Elena Brower, Certified Yoga Instructor. *Element: AM & PM Yoga for Beginners*. 2008. [DVD].

Elena Brower, Certified Yoga Instructor. *Element: Yoga for Beginners*. 2007. [DVD].

THIS PAGE INTENTIONALLY LEFT BLANK

BASEBALL

OBJECTIVE

While trying to prevent the opposing team from scoring runs, each team tries to score as many runs as possible.

SCORING

One point is awarded as a member completes a circuit around the bases.

DEFINITIONS

Ball. A pitch that is outside the strike zone.

Bunt. When the batter drops the ball as a soft ground ball on the infield.

Double play. When two outs are made on the same play.

Fair ball. The ball when it is legally in play.

Fly ball. A ball batted high into the air.

Force play. When a runner is forced to move to the next base because the batter becomes a runner.

Foul ball. A ball that is hit into foul territory (as illustrated in Figure Q-1).

Foul territory . The area outside the foul lines (as illustrated in Figure Q-1).

Home run. When a batter hits a fair ball over the fence, or circles all bases on a hit inside the fence without getting an out on their way around.

Inning. Consists of a top and a bottom half, during which each team will get to bat and field.

Out. An out can be given due to strikeout, force-out, tag-out, and fly-out:

- **Fly-out.** When a fly ball is caught before it touches the ground or fence.
- **Force-out.** When a fielder touches the base with the ball in their possession before the runner reaches the base during a force play.
- **Strikeout.** When a batter has three strikes.
- **Tag-out.** When a fielder tags a runner with the ball when they are not on a base.

Strike. A pitch, in the strike zone at which the batter does not swing, at which the batter swings and misses, or that the batter hits into foul territory during their first two hits. A foul ball on the third is not considered a strike.

Strike zone. The area over the home plate, between the batter's knees and the midpoint between the top of their shoulders and the top of their pants.

Walk. A batter is awarded first base if four "balls" are pitched to the batter during one time up to bat.

NUMBER OF PLAYERS

Nine players per team.

EQUIPMENT

- Bases (four),
- Bats (two),
- Batter's helmets (two),
- Baseball (extras should be on hand),
- Various gloves, and
- Baseball / softball field.

BASIC RULES

The game consists of nine innings, with three outs per inning (for each team). In the case of a tie, the game will continue for additional innings until a team scores an additional run, breaking the tie. Innings may be reduced due to time constraints.

One team takes the field first, taking up the various positions, to include: pitcher, catcher, first baseman, second baseman, third baseman, shortstop, left fielder, centre fielder, and right fielder.

The other team bats first in the top half of the inning, according to the batting order for their players.

The pitcher attempts to get the batter out, preventing him or her from reaching first base and the subsequent bases. A batter is out if they receive a strikeout, force-out, tag-out, or fly-out.

The batter's objective is to get around the bases before the ball reaches the base. The batter has to attempt to get to first base before the ball reaches the base. While the ball is in play the batter can attempt to reach subsequent bases. Once their play is over the next batter is up.

A team scores a run when a player has safely touched all three bases and has made it back to home base, or hits the ball over the fence resulting in a home run.



Further details on the sport of baseball can be found in *The Sports Rules Book: Essential Rules for 54 Sports* (1998), pp. 25–35.

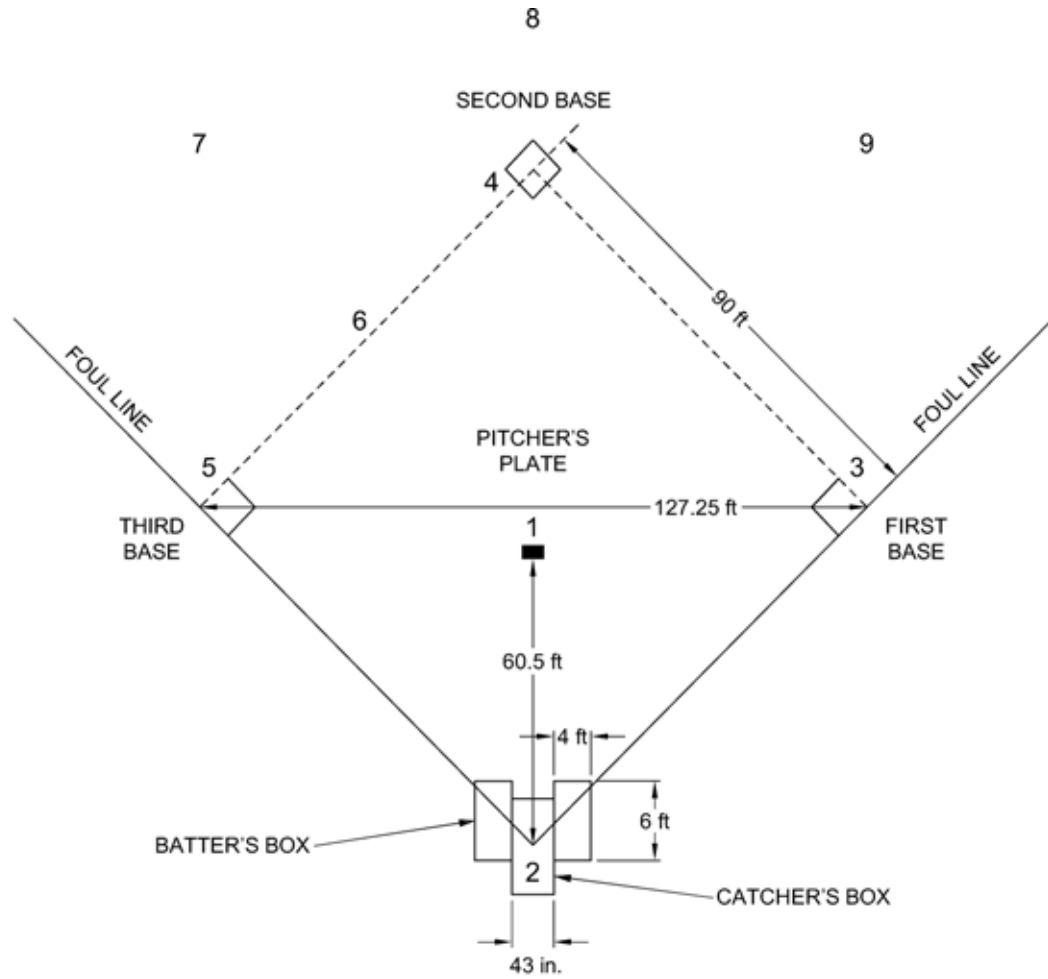

LEGEND

- 1. Pitcher
- 2. Catcher
- 3. First Baseman
- 4. Second Baseman
- 5. Third Baseman
- 6. Shortstop
- 7. Left Fielder
- 8. Centre Fielder
- 9. Right Fielder

Note. From The Sports Rules Book: Essential Rules for 54 Sports (p. 31), by T. Hanlon, 1998, USA: Human Kinetics Publishers, Inc. Copyright 1998 by Human Kinetics Publishers, Inc.

Figure Q-1 Baseball Diamond

BASEBALL SCORE SHEET

Team A

NAMES

Team B

NAMES

Record the number of runs scored by each team for each inning.

	Inning 1	Inning 2	Inning 3	Inning 4	Inning 5	Inning 6	Inning 7	Inning 8	Inning 9	TOTAL
Team A										
Team B										

Note. The scorekeeper must sign the back of the score sheet when completed.

BASKETBALL

OBJECTIVE

Teams attempt to score as many points as possible by passing the basketball through the opposing teams' basket. The team with the highest score at the end of the game is the winner.

SCORING

Field goal. A basket worth two points if scored inside the three-point line and three points if scored from outside the line (as illustrated in Figure R-1).

Free throw. A basket worth one point.

DEFINITIONS

Dribble. Dribbling consists of bouncing the ball on the floor, using only one hand at a time. This can be done while moving on the court or while the player is stationary. Once a player stops dribbling and holds the ball, they cannot dribble again until another player touches the ball.

Double dribble. Dribbling with both hands at once is a violation that results in a turnover or when a player is dribbling, stops and begins again.

Field goal. A two or three-point basket.

Foul. A foul is awarded to a player or coach for misconduct and includes the following:

Away from the ball. Committed by a player in a play not involving the player with the ball.

Blocking and charging. Blocking is illegal contact by a defender, impeding the progress of an offensive player. Charging is illegal contact by an offensive player, pushing or moving into the defender's torso.

Delay of game. When a player prevents the ball from being promptly put into play.

Double personal. Occurs when two opposing players commit personal fouls at the same time.

Double technical. When two opposing players commit technical fouls at the same time.

Elbow. When a player elbows a member of the opposing team.

Excessive timeout. When a team calls a timeout when they have no timeouts left, they are granted a technical foul, but the timeout is allowed.

Face guarding. When a defender places a hand in the face or eyes of an opponent they are guarding from the rear, if the opponent does not have the ball.

Fighting and flagrant fouls.

- **Hand checking.** When a defender uses their hands to check the progress of offensive players when those players are in front of them.
- **Hanging on the rim.** When a player hangs off the rim of the basket, unless it is to protect themselves or another player.
- **Offensive.** If a defender has established legal position in a dribbler's path, the dribbler cannot make contact with the opponent.
- **Personal.** A wide variety of contact fouls including holding, pushing, charging, tripping, and illegally interfering with a player's progress.
- **Player-control.** When the dribbler commits an offensive by charging into a defender who has established legal position, this is called charging.
- **Technical.** Can be on a player, coach, etc. and does not involve contact with the opponent while the ball is alive. Some include profanity, delay of game, excessive time outs, unsportsmanlike conduct, and hanging on the rim.
- **Unsportsmanlike conduct.** Includes actions such as disrespectfully addressing an official; trying to influence an official's decision; arguing with an official; taunting an opponent; etc.

Free throw. A shot given to a player from the free throw line as a result of a foul. It is worth one point.

Pass. The movement of the ball by a player to another player by throwing, batting, or rolling the ball.

Pivot. When a player holding the ball pivots with one foot kept at a point of contact with the floor, while stepping in other directions with the other foot.

Rebound. When a player controls possession of a missed shot, either by a teammate or an opponent.

Sideline pass. When a player throws the ball in from the sidelines of the court.

Traveling. When a player advances on the court with the ball without dribbling it.

Violations. When a player breaks a rule without contact. These include: basket interference and goaltending, double dribble, faking a free throw, kicking or hitting the ball, out of bounds, shot clock, traveling and throw in.

NUMBER OF PLAYERS

Five players per team on the court at a time.

EQUIPMENT

- Basketball,
- Gymnasium / outdoor court, and
- Nets (two).

BASIC RULES

The game consists of four 8-minute quarters.

Teams will consist of a point guard, an off guard / shooting guard, a small forward, a power forward and a centre / post.

The game begins with what is known as a “jump ball”. A player from each team will meet face to face at the centre of the court. When the official tosses the ball straight up between them, both players will attempt to catch or hit the ball to a teammate.

Once the game has begun, the player in possession of the ball must dribble at all times in order to continue to move forward along the court. The player may pass the ball at any time to a teammate.

If a player in possession of the ball stops moving, they may only pivot on the spot or take a maximum of three steps and then pass or shoot the ball towards the basket.

If a team scores, the opposing team will gain possession of the ball. The opposing team throws the ball inbounds to put the ball back into play. On this throw-in, the thrower cannot step on or over the line while still in possession of the ball.

During the game, if the ball is tossed out of bounds or a person is fouled, the opposite team will gain the ball where a free throw will be awarded or a sideline pass will take place.



Further details on the sport of basketball can be found in *The Sports Rules Book: Essential Rules for 54 Sports* (1998), pp. 37–46.

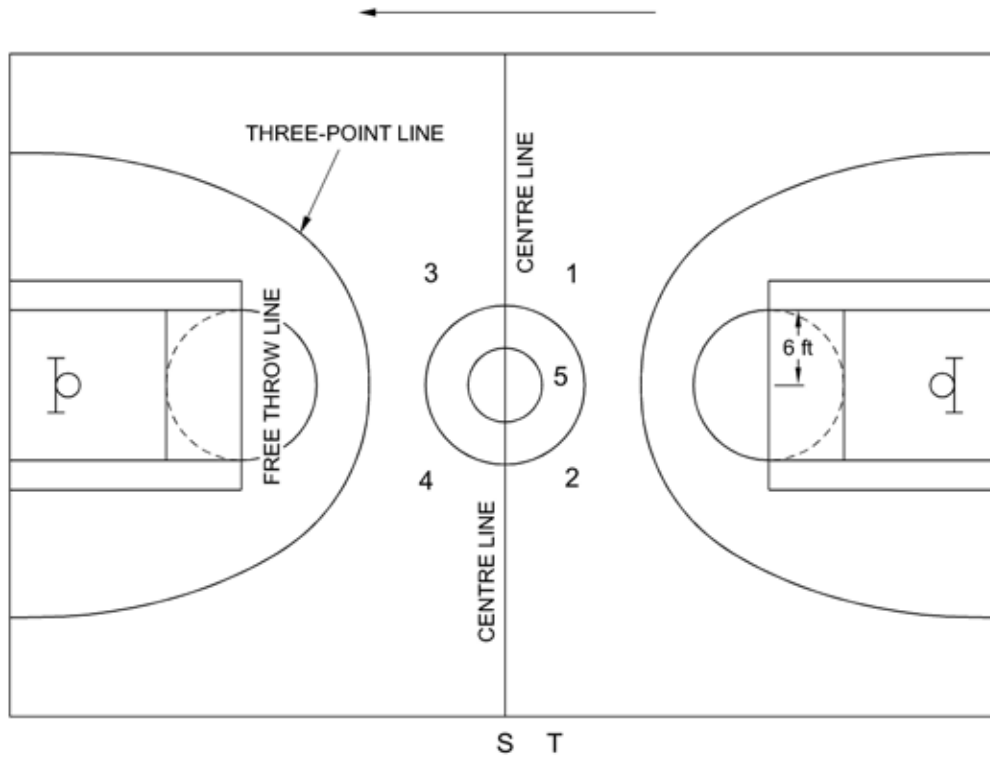

LEGEND

- 1. Point Guard
- 2. Off Guard or Shooting Guard
- 3. Small Forward
- 4. Power Forward
- 5. Centre or Post
- S Scorekeeper
- T Timekeeper

Note. From The Sports Rules Book: Essential Rules for 54 Sports (p. 41), by T. Hanlon, 1998, USA: Human Kinetics Publishers, Inc. Copyright 1998 by Human Kinetics Publishers, Inc.

Figure R-1 Basketball Court

BASKETBALL SCORE SHEET

Team A

NAMES

Team B

NAMES

Record the number of points awarded to each team within each quarter.

A basket is worth two points if it is scored inside the three-point line and three if scored from outside the line and a free throw is worth one point.

First Quarter		Second Quarter		Third Quarter		Fourth Quarter	
Team A	Team B	Team A	Team B	Team A	Team B	Team A	Team B
TOTAL		TOTAL		TOTAL		TOTAL	

Note. The scorekeeper must sign the back of the score sheet when completed.

THIS PAGE INTENTIONALLY LEFT BLANK

FLOOR HOCKEY

OBJECTIVE

Teams attempt to score as many points as possible by shooting the ball into the opposing team's net. The team with the highest score at the end of the game is the winner.

SCORING

A player shooting the ball off their stick into the net, scores a goal.

DEFINITIONS

Faceoff. When two players meet to try to gain possession of the ball when the referee drops it.

Goal. A point / goal is scored when a player gets the ball across the goal line.

Rebound. A ball that bounces off the goalkeeper or the goal post.

Save. When the goalkeeper prevents a goal from being scored.

NUMBER OF PLAYERS

Six players per team on the floor at one time.

EQUIPMENT

- Hockey ball,
- Hockey sticks for the number of players,
- Goalie sticks (two),
- Goalie equipment, and
- Hockey nets (two).

BASIC RULES

A game consists of three 20-minute periods.

Teams will consist of a goalkeeper, three forwards—centre, left wing, and right wing—and two defencemen.

A game begins with a faceoff between two opposing players where an official drops the ball at the centre of the playing field / gymnasium.

Players advance with the ball while stickhandling the ball or passing it to fellow teammates. The ball must be in motion at all times.

Every time a goal is scored, the players return to the initial set-up for a faceoff at the centre of the area of play.

If an attacker in the team's attacking zone causes the play to stop, a faceoff will occur at the nearest faceoff spot in the neutral zone (the central portion between the blue lines).

If a defender in the team's defensive zone causes the play to stop, a faceoff occurs at the point of stoppage.



Further details on the sport of hockey can be found in *The Sports Rules Book: Essential Rules for 54 Sports* (1998), pp. 159–168. These rules then must be adapted for floor hockey.

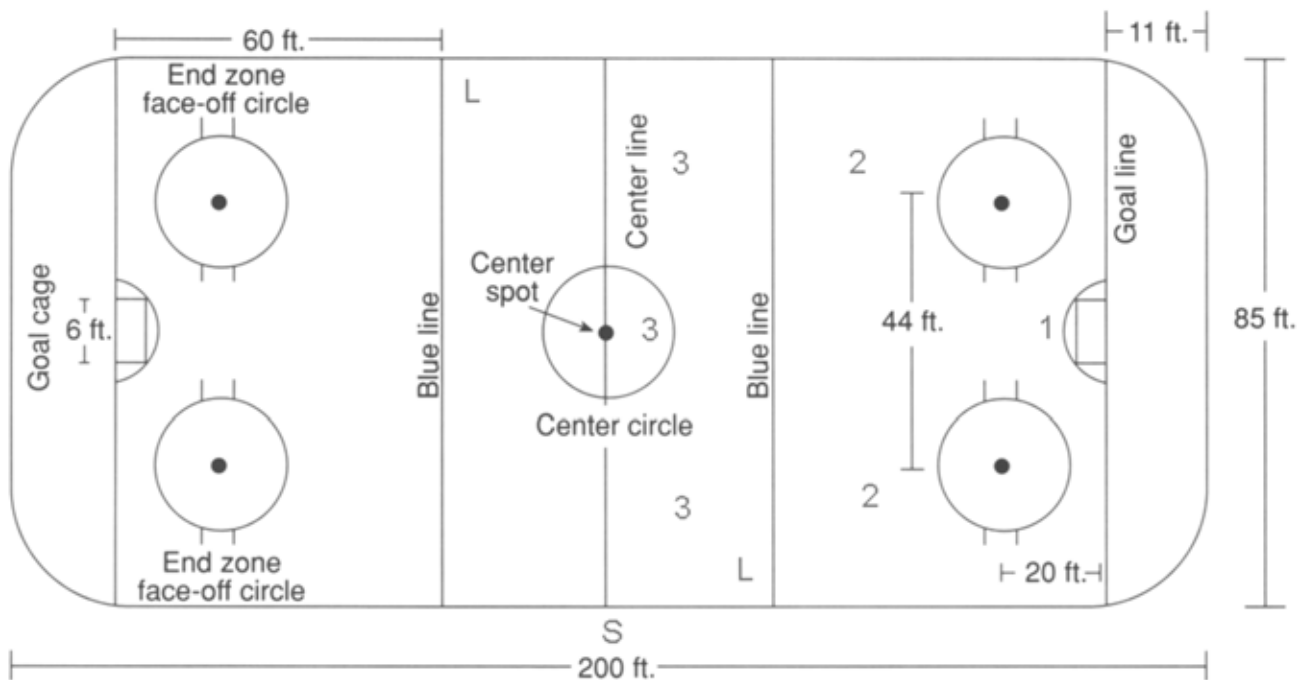

- | | |
|--------------|---------------|
| 1 Goalkeeper | S Scorekeeper |
| 2 Defenseman | L Linesman |
| 3 Forward | |

Note. From The Sports Rules Book: Essential Rules for 54 Sports (p. 162), by T. Hanlon, 1998, USA: Human Kinetics Publishers, Inc. Copyright 1998 by Human Kinetics Publishers, Inc.

Figure S-1 Hockey Set-Up

FLOOR HOCKEY SCORE SHEET

Team A

NAMES

Team B

NAMES

Record the number of goals achieved by each team within each period.

First Period

Second Period

Third Period

Team A	Team B	Team A	Team B	Team A	Team B
TOTAL		TOTAL		TOTAL	

Note. The scorekeeper must sign the back of the score sheet when completed.

FOOTBALL (FLAG / TOUCH)

OBJECTIVE

Teams attempt to score as many points as possible through touchdowns. The team with the highest score at the end of the game is the winner.

SCORING

Touchdown. Worth six points and scored when a player carries the ball into the opponent's end zone or catches the ball in the opponent's end zone before it touches the ground. After a touchdown has been scored, the scoring team can make a one-point convert attempt from the 5-yard line (approximately 4-1/2 m / 15 feet) or a two-point convert attempt from the 10-yard line (approximately 11 m / 36 feet).

Safety. An interception return to the opponent's end zone, on any extra-point play by the defence, will result in the defence scoring two points, plus they will gain possession for the next series at their own 5-yard (4-1/2 m / 15 feet) line.

Rouge. A team is awarded one point when they legally kick the ball into the opponent's end zone and the ball is not brought out of the end. To score off a kick off, the ball must land in the field of play or in the end zone before it goes out of bounds.

DEFINITIONS

Convert. A pass or a run attempt; no kicking allowed.

Dead ball. When the ball is no longer in play and the play is over.

First down. Is a new set of three downs. Each team, when they are the offence, get three downs in which to make a play.

Forward pass. When the ball is intentionally thrown or handed towards the opponent's goal line.

Fumble. When a player loses possession of the ball while the play is still in progress.

Punt. When the ball is deliberately dropped and then kicked with the foot or leg before the ball touches the ground.

Scrimmage line. The line where the players line up for the snap.

Snap. When a player designated as the centre passes the ball between the legs to the quarterback.

Touchback. Occurs when the ball is dead on or behind a team's own goal line, provided the ball's force came from an opponent and it is not a touchdown.

NUMBER OF PLAYERS

Seven players per team on the field at one time for touch football. Eight players per team on the field at one time for flag football.

EQUIPMENT

- Football,
- Flags / ribbons,
- Field, and
- Safety / protective equipment.

BASIC RULES

The game consists of four 15-minute quarters.

Whichever team takes first possession of the ball is the offence. The other team becomes the defence.

The offence has three downs to obtain 10 yards, keep possession of the ball, and attempt to score. If they do not gain 10 yards and a first down, possession of the ball changes and that team then becomes the offence.

To begin the game, a team will kickoff from their own 45-yard line (or on a non-regulation field, ten yards back from the centre line). The remaining players of the team must stay behind the kickoff line until the ball has been kicked.

At the kickoff, all players of the receiving team must be at least 20 yards away from the kickoff line.

To begin a series of three downs, the ball will be placed on the ground at the point where the ball carrier was touched after the kickoff. All members of the offensive team will line up on or behind the line of scrimmage. A player designated as the centre will begin the play by snapping the ball between the legs to the quarterback who must receive the ball from a minimum of five yards behind the line of scrimmage.

The defensive players must be at least one yard from the line of scrimmage on the opposite side during the snap.

All players on the offence, with the exception of the centre, can be in motion prior to the snap. They may not cross the line of scrimmage until after the snap.

In touch football, play is terminated when a defender touches the ball carrier with the hand. In flag football, play is terminated when a defender removes the ball carrier's flag.

The defensive team will have one player during scrimmage play, called the rusher, who will pursue the quarterback after the ball is snapped. The rusher must be at least five yards away from the line of scrimmage at the time the ball is snapped and cannot be lined up directly with the centre of the opposing team.

No player is permitted to block or obstruct the rusher in the direct path to the quarterback.

Teams are only permitted one forward pass on each scrimmage play. Forward passes are not permitted on kickoffs or after punts.

The team that plays defence at the beginning of the first half receives possession at the start of the second half.

If a team fails to make it across midfield within three plays, possession of the ball changes.

Once a ball is punted, the team gives up possession of the ball.

There are no fumbles in touch football.

Must be played as non-contact. Blocking and tackling are not allowed.



Further details on the sport of football can be found in *The Sports Rules Book: Essential Rules for 54 Sports* (1998), pp. 125–136. These rules must be adapted for flag / touch football. Some of these modifications can be found on pp. 132–133. Further rules may be found in the *National Football Federation's Touch Football Rule Book*.

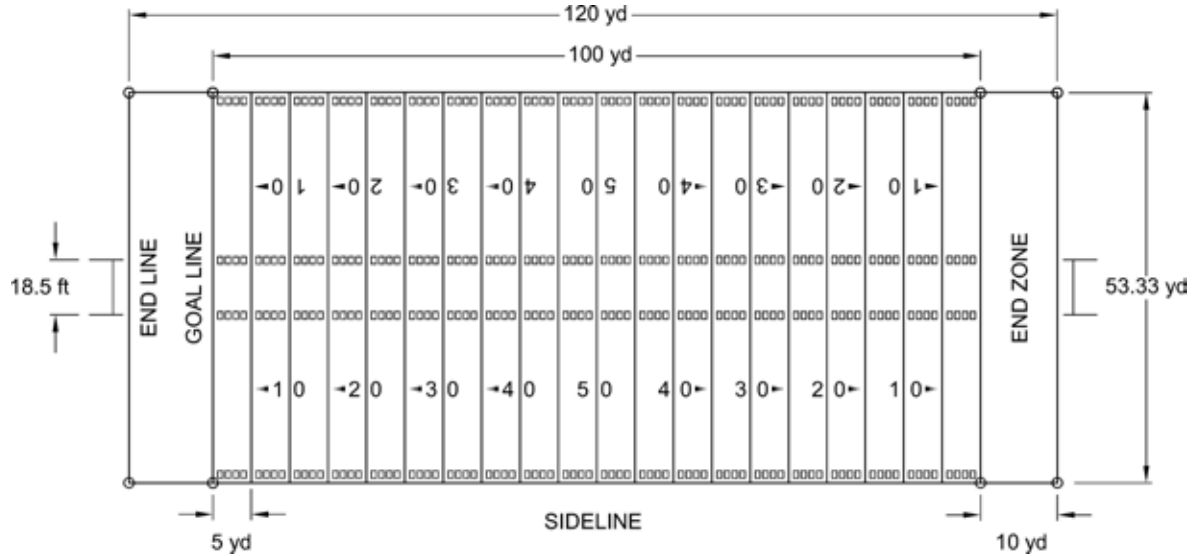

Note. From *The Sports Rules Book: Essential Rules for 54 Sports* (p. 129), by T. Hanlon, 1998, USA: Human Kinetics Publishers, Inc. Copyright 1998 by Human Kinetics Publishers, Inc.

Figure T-1 Football Field

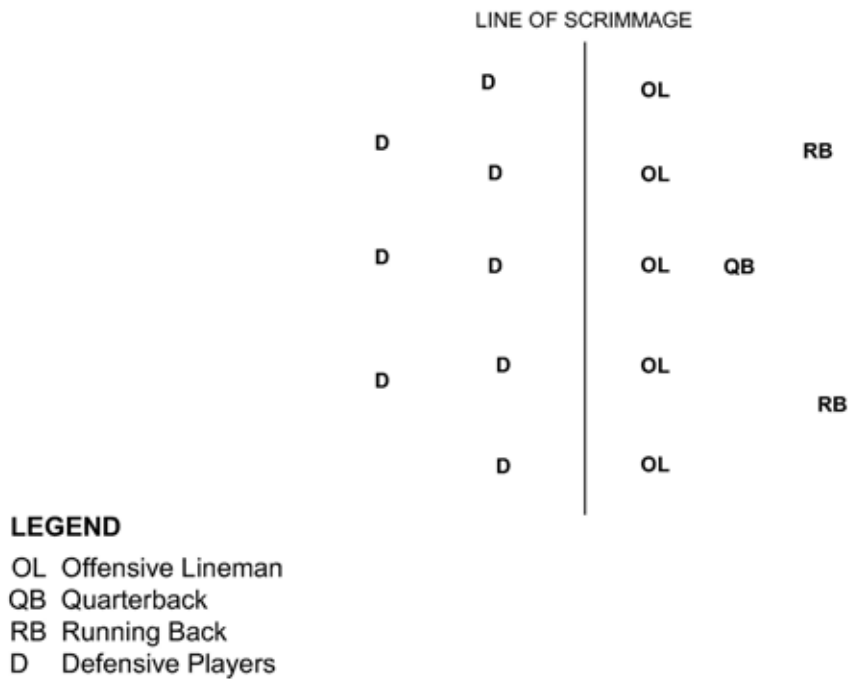

Note. Created by Director Cadets 3, 2007, Ottawa, ON: Department of National Defence.

Figure T-2 Line of Scrimmage

FOOTBALL SCORE SHEET

Team A

NAMES

Team B

NAMES

Record the number of points awarded to each team within each quarter.

A touchdown is worth six points. A safety is worth two points. A rouge is worth one point.

First Quarter		Second Quarter		Third Quarter		Fourth Quarter	
Team A	Team B	Team A	Team B	Team A	Team B	Team A	Team B
TOTAL		TOTAL		TOTAL		TOTAL	

Note. The scorekeeper must sign the back of the score sheet when completed.

LACROSSE

OBJECTIVE

Teams attempt to score as many points as possible by passing the ball into the opposing team's goal. The team with the highest score at the end of the game is the winner.

SCORING

A goal is scored when the ball passes completely over the goal line, between the posts and under the cross bar of the opponent's goal.

DEFINITIONS

Blocking. Occurs when one player moves into the path of an opponent with the ball without giving the opponent a chance to stop or change direction without contact.

Critical scoring area. An area at each end of the field, where the attacking team shoots for a goal.

Deputy. A player on the defensive goalkeeper's team who may enter the goal circle when his or her team is in possession of the ball and the goalkeeper is out of the goal circle.

Draw. With two opposing players toeing the centreline, holding their crosses in the air, parallel to the centreline. The umpire places the ball between the players and when they call ready the players pull their sticks up and away, lifting the ball into the air. All other players must be outside the centre circle for the draw.

Free space to goal. The path to the goal within the critical scoring area.

Marking. Guarding an opponent within a stick's length.

Penalty lane. The path to the goal that is cleared when a free position is awarded to the attacking team within the critical scoring area in front of the goal line.

Pick. A technique used by a player without the ball to force an opponent to take a different direction. The player must give the opponent time to see the pick and react to it.

Throw. Two players of opposing teams stand 1 m (3-1/3 feet) apart; the umpire stands 4–8 m (13–26 feet) away, and throws the ball into the air and the players take it as they move toward the field. No other player can be within 4 m (13 feet) of the players taking the throw.

NUMBER OF PLAYERS

Twelve players per team on the field at one time.

EQUIPMENT

- Ball,
- Field crosses for the number of players,
- Goalkeeper's crosse (two),
- Goalkeeper's helmet, face mask, and throat and chest protector (two of each), and
- Mouth guards for the number of players.

BASIC RULES

The game consists of two 30-minute halves.

The team consists of a goalkeeper, point, cover-point, third man, left defence wing, right defence wing, left attack wing, right attack wing, third home, second home, first home, and centre (as illustrated in Figure U-1).

The game begins with a draw.

The team in possession of the ball attempts to score goals by advancing the ball down the field. This is done by carrying, throwing, rolling, or batting the ball.

If the ball goes out of bounds, it is given to the closest player. If two players of opposing teams are an equal distance from the ball, the game is continued with a throw.

Only one player can be in the goal circle at a time. This can only be the goalkeeper or the deputy.

Within the goal circle, the goalkeeper must clear the ball within 10 seconds. This can be done with the goalkeeper's crosse, hands, or body.

After each goal, the ball is put back into play with a draw.



Further details on the sport of lacrosse can be found in *The Sports Rules Book: Essential Rules for 54 Sports* (1998), pp. 179–186.

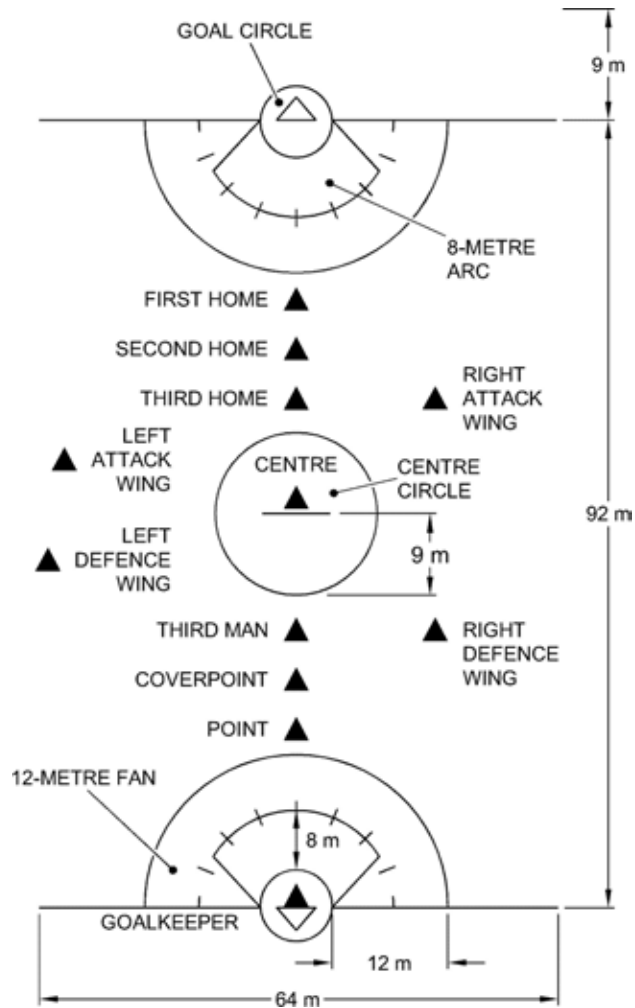

Note. From *The Sports Rules Book: Essential Rules for 54 Sports* (p. 182), by T. Hanlon, 1998, USA: Human Kinetics Publishers, Inc. Copyright 1998 by Human Kinetics Publishers, Inc.

Figure U-1 Lacrosse Field

LACROSSE SCORE SHEET

Team A	
NAMES	

Team B	
NAMES	

Record the number of goals achieved by each team within each half.

First Half	
Team A	Team B
TOTAL	

Second Half	
Team A	Team B
TOTAL	

Note. The scorekeeper must sign the back of the score sheet when completed.

RINGETTE (OFF ICE VERSION)

OBJECTIVE

Teams attempt to score as many points as possible by getting the ring in the opposing team's net. The team with the highest score at the end of the game is the winner.

SCORING

One point for every time a ring passes into the opposing team's net.

NUMBER OF PLAYERS

Six players per team on the floor at one time.

EQUIPMENT

- Nets (two),
- Safety equipment,
- Rubber ring,
- Straight sticks for number of players, and
- Goalkeeper's sticks and masks (two of each).

BASIC RULES

The game is played in two 20-minute periods. Teams consist of a goalkeeper, two defencemen, and three forwards. The stick is placed inside the ring to play. The ring is passed up the playing area in order to get the ring in the opposing team's net.

Play begins with the visiting team being given a free pass in the centre free pass circle (which is like a faceoff circle in hockey). Free passes are used in ringette to restart play. The ring is placed in the free pass circle for this and one player gets to take possession, having five seconds to pass the ring to a teammate. Shots on goal are allowed from the free pass. If the ring is within the goal crease, the only player who is allowed to touch it is the goalie. The goalie will pick up the ring and throw it like a Frisbee to a teammate but it cannot be thrown beyond the blue line. The goalkeeper can also hit the ring with their stick or foot to move it out of the goal crease.



Further details on the sport of ringette can be found at <http://www.ringette.ca>

TEAM A'S DEEP DEFENSIVE ZONE

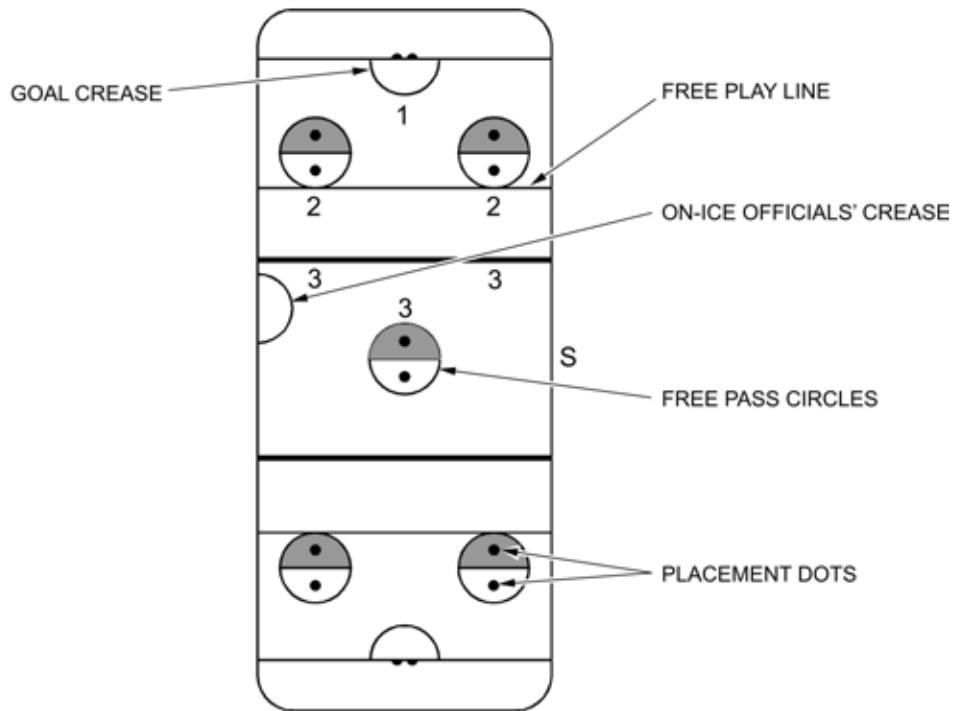

TEAM A'S DEEP OFFENSIVE ZONE

LEGEND

- 1. Goalkeeper
- 2. Defenceman
- 3. Forward
- S Scorekeeper

Note. From How Ringette is Played, by Ringette Canada, n.d. Retrieved October 30, 2006, from <http://www.ringette.ca/e/about/played.htm>

Figure V-1 Ringette Ice / Playing Field

RINGETTE SCORE SHEET

Team A

NAMES

Team B

NAMES

Record the number of goals achieved by each team within each period.

First Period

Team A	Team B
TOTAL	

Second Period

Team A	Team B
TOTAL	

Note. The scorekeeper must sign the back of the score sheet when completed.

THIS PAGE INTENTIONALLY LEFT BLANK

SOCCER

OBJECTIVE

Teams attempt to score as many points as possible by getting the ball in the opposing team's net. The team with the highest score at the end of the game is the winner.

SCORING

A point is scored for every goal made into the net that completely crosses the goal line.

DEFINITIONS

Corner kick. Awarded to the opposing team when players kick the ball over their own goal line. All opposing players must be at least 10 yards (9 m / 29.5 feet) from the ball for a corner kick.

Dribble. To move the ball with the feet in a continuous motion by passing the ball from one foot to the other.

Foul. Results in a direct or indirect free kick for the opposing team at the spot where the foul occurred. Fouls include:

- kicking, tripping or pushing;
- jumping into an opponent;
- violently or dangerously charging an opponent;
- striking an opponent with the hand, arm, or elbow;
- holding an opponent's body or clothing;
- playing the ball anywhere on the arm;
- going offside;
- obstructing an opponent by deliberately blocking their path;
- kicking too high, putting an opponent in danger;
- bending low, putting themselves in danger;
- unsportsmanlike conduct;
- charging an opponent when the ball is no more than one step away;
- charging into the goalkeeper while in the goal area, preventing them from playing the ball or retaining possession of the ball; and
- the goalkeeper taking more than four steps before releasing the ball.

Free kick. Direct free kicks are awarded for fouls on a player; indirect free kicks are awarded for other violations made by the opposing team.

Goal kick. Occurs when a player kicks the ball over the opposing team's goal line. The opposing team is awarded the goal kick. Opposing players must be outside the penalty box area; either the goalkeeper or another player may kick the ball. The ball must be kicked beyond the penalty box area to be put into play. The player who performs the goal kick cannot touch the ball again until another player has done so.

Heads the ball. When a player hits the ball with their head.

Penalty kick. Is awarded to a team when an opposing player commits an intentional foul. All players, except the kicker and the goalkeeper, must stand outside the penalty area, at least ten yards (9 m / 29.5 feet) from the ball. The goalkeeper must stand on the goal line and not move their feet until the kick is made. If a goal is not scored and the ball goes out of bounds after being touched by the goalkeeper, the attacking team gets a corner kick.

Throw-in. Is awarded to a team when the ball goes over the sideline and was last touched by an opponent. A player throws the ball in from over their head, keeping both feet on the ground while releasing the ball. At least part of each foot must be on or behind the sideline.

NUMBER OF PLAYERS

Up to 11 players per team on the field at one time.

EQUIPMENT

- Soccer ball,
- Nets (two), and
- Field or gymnasium.

BASIC RULES

The game consists of two 45-minute halves. Teams will consist of a goalkeeper, defenders, midfielders, and forwards, or strikers. The game begins with a kickoff at the centre of the playing field, where the ball is placed in a stationary position at the centre spot. All players must be on their team's half of the playing field before the kickoff takes place. The player who kicks off may not touch the ball again until another player has. Players have to move the ball up the field with their feet, head, or chest. They may not touch the ball with their hands. The game continues in this manner, with players dribbling the ball and moving it toward the opposing team's goal in order to score.

When a goal is scored the play begins again with the team losing the goal taking the kickoff.

A goal may not be scored directly off a kickoff, goal kick, or throw-in.



Further details on the sport of soccer can be found in *The Sports Rules Book: Essential Rules for 54 Sports* (1998), pp. 237–245.

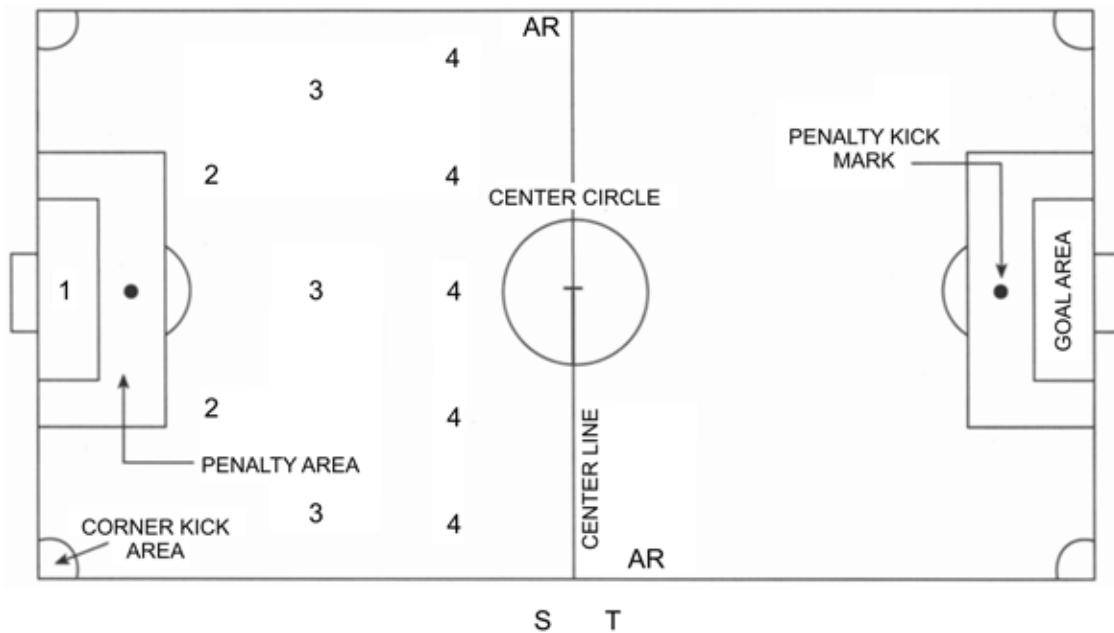

LEGEND

- 1. Goalkeeper
- 2. Defender
- 3. Midfielder
- 4. Forward
- S Scorekeeper
- T Timekeeper
- AR Assistant Referee

Note. From The Sports Rules Book: Essential Rules for 54 Sports (p. 241), by T. Hanlon, 1998, USA: Human Kinetics Publishers, Inc. Copyright 1998 by Human Kinetics Publishers, Inc.

Figure W-1 Soccer Field

SOCCER SCORE SHEET

Team A

NAMES

Team B

NAMES

Record the number of goals achieved by each team within each half.

First Half

Team A	Team B
TOTAL	

Second Half

Team A	Team B
TOTAL	

Note. The scorekeeper must sign the back of the score sheet when completed.

SOCCER BASEBALL / KICKBALL

OBJECTIVE

While trying to prevent the opposing team from scoring runs, each team tries to score as many runs as possible. A run is scored when a team's player runs (in a counter-clockwise direction) and steps on all three bases and the home plate.

SCORING

One point is awarded as a member completes a circuit around the bases. A game lasts five innings where the team with the highest score wins, unless there is a tie. In the case of a tie the game will continue for additional innings until a team scores an additional run, breaking the tie.

DEFINITIONS

Double. A kick in which the batter safely runs to second base.

Double play. When two outs are made on the same play.

Fair ball. The ball when it is legally in play.

Force play. Occurs when a runner is forced to advance to the next base because the batter becomes a runner.

Foul play. Any ball hit into foul territory.

Foul territory. The area outside the foul lines.

Home run. When a batter kicks a fair ball over the fence or circles all bases on a kick that was inside the fence.

Lead off. When a runner leads off a base before the ball has left the pitcher's hand.

Legal touch. When a defensive player tags a runner with the ball while the runner is not on a base. This results in an out.

Out. There are a number of types of outs, which include:

- **Fly-out.** When a fly ball is caught before it touches the ground or fence.
- **Force-out.** When a fielder touches the base with the ball in their possession before the runner reaches.
- **Strikeout.** When a batter has three strikes.
- **Tag-out.** When a fielder tags a runner with the ball when they are not on a base. This is also known as a legal touch.

Steal. When a runner attempts to steal a base during a pitch to the kicker.

Tag-up rule. If the ball is caught in the air after the kicker has kicked it, the kicker is out. Other players who are on bases must touch the base they were on after the ball is caught before they can run to the next base.

NUMBER OF PLAYERS

Nine players per team on the field at one time.

EQUIPMENT

- Soccer ball,
- Baseball / softball field or a gymnasium or field, and
- Bases / pylons (four).

BASIC RULES

The game consists of five innings, with three outs per inning (for each team).

One team takes the field first, taking up the various positions, to include a pitcher, catcher, first baseman, second baseman, third baseman, shortstop, left fielder, centre fielder, right fielder, and other fielders depending on the number of players.

When pitching, the ball must touch the ground at least once and cannot be higher than one foot (30 cm) above the plate when it gets to the kicker. The ball should be pitched to roll as smoothly as possible.

A ball is put into play once the pitcher rolls the ball toward home plate and the kicker has attempted to kick the ball.

The kicker must wait for the ball to be within 1 m of the home plate before they can attempt to kick the ball.

Leading off and stealing bases is not allowed. Bunts are not permitted.

The kicker at home plate must kick the ball with the leg (below the knee) or foot.

Field players can tag the runner out while either carrying the ball or throwing it at the runner and making contact. Thrown balls are to hit below the waist.

A runner who leaves their base before the pitch reaches home plate or before the pitch is kicked, is out and the ball is considered dead.



Further details on the sport of soccer baseball / kickball can be found at <http://www.kickball.com>

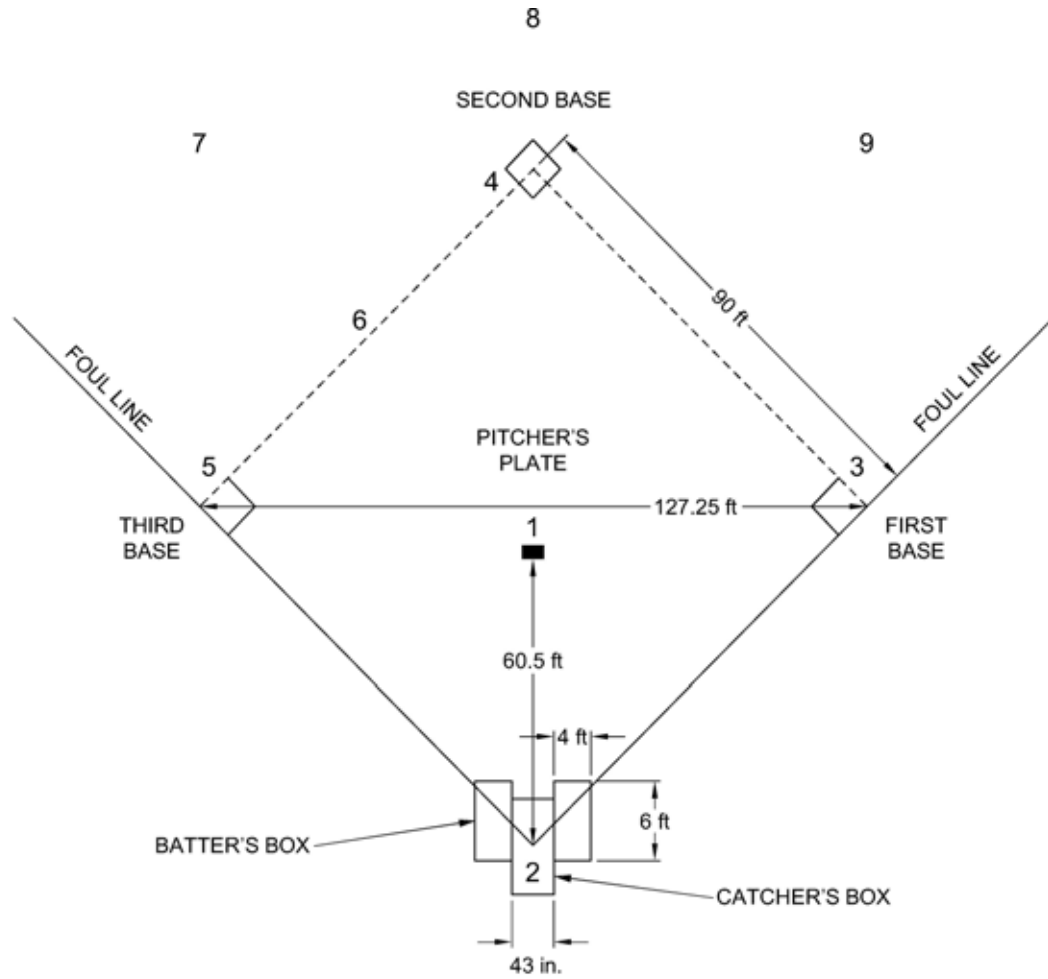

LEGEND

1. Pitcher
2. Catcher
3. First Baseman
4. Second Baseman
5. Third Baseman
6. Shortstop
7. Left Fielder
8. Centre Fielder
9. Right Fielder

Note. From The Sports Rules Book: Essential Rules for 54 Sports (p. 31), by T. Hanlon, 1998, USA: Human Kinetics Publishers, Inc. Copyright 1998 by Human Kinetics Publishers, Inc.

Figure X-1 Baseball Diamond (used for soccer baseball)

SOCCER BASEBALL / KICKBALL SCORE SHEET

Team A

NAMES

Team B

NAMES

Record the number of runs scored by each team for each inning.

	Inning 1	Inning 2	Inning 3	Inning 4	Inning 5	TOTAL
Team A						
Team B						

Note. The scorekeeper must sign the back of the score sheet when completed.

SOFTBALL

OBJECTIVE

While trying to prevent the opposing team from scoring runs, each team tries to score as many runs as possible. A run is scored when a team's player runs (in a counter-clockwise direction) and steps on all three bases and the home plate.

SCORING

One point is awarded as a member completes a circuit around the bases. A game lasts seven innings where the team with the highest score wins, unless there is a tie. In the case of a tie the game will continue for additional innings until a team scores an additional run, breaking the tie.

DEFINITIONS

Ball. A pitch that is outside the strike zone.

Bunt. When a batter hits the ball by letting the ball meet the bat to drop as a soft ground ball on the infield.

Double play. When two outs are made on the same play.

Fair ball. The ball when it is legally in play.

Fake tag. A form of obstruction of a runner by a fielder who neither has the ball nor is about to receive it. The umpire will award the runner the base they would have made, if the obstruction had not been made.

Fly ball. A ball batted high into the air.

Fly-out. A fly ball that is caught before it touches the ground or the fence.

Force play. When a runner is forced to advance to the next base because the batter becomes a runner.

Foul play. Any ball hit into foul territory.

Foul territory. The area outside the foul lines (as illustrated in Figure Y-1).

Home run. When a batter hits a fair ball over the fence or circles all bases on a ball that was hit inside the fence.

Inning. An inning consists of a top and a bottom. During either the top or bottom half each team will get the opportunity to bat and field accordingly.

Interference. This occurs when an offensive player impedes or confuses a defensive player as they are trying to make a play. Interference can be physical or verbal.

Lead off. When a runner leads off a base once the ball has been batted, touches the ground, or reaches home plate, but must return to the base if the ball is not hit.

Out. There are a number of types of outs, which include:

- **Fly-out.** When a fly ball is caught before it touches the ground or fence.
- **Force-out.** When a fielder touches the base with the ball in their possession before the runner reaches.
- **Strikeout.** When a batter has three strikes.
- **Tag-out.** When a fielder tags a runner with the ball when they are not on a base. This is also known as a legal touch.

Overslide. When a player over slides first base when running. It is allowed at first base, but at second and third base, the runner may be tagged out.

Steal. In fast-pitch, a runner may attempt to steal a base during a pitch to the batter.

Strike zone. The area over the home plate, between the batter's back shoulder and front knee.

Walk. A batter is awarded first base if four "balls" are pitched to the batter during one time up to bat.

NUMBER OF PLAYERS

10 players per team on the field at a time if team is not batting.

EQUIPMENT

- Bases (four),
- Bat,
- Batter's helmets,
- Softball,
- Various gloves for the number of players, and
- Baseball / softball field.

BASIC RULES

The game consists of seven innings, with three outs per inning (for each team).

One team takes the field first, taking up the various positions, to include a pitcher, catcher, first baseman, second baseman, third baseman, shortstop, left fielder, centre fielder, right fielder, and extra fielder.

The other team bats first in the top half of the inning, according to the batting order for their players.

The pitcher attempts to get the batter out, preventing them from reaching first base and the subsequent bases.

The pitcher must use an underhand pitch.

A batter is out if they receive a fly-out, force-out, strikeout or tag-out.

The batter's objective is to get around the bases without being tagged and before the ball reaches the base.

A team scores a run when a player has safely touched first, second, and third base, and has made it back home or hits the ball over the fence.



Further details on the sport of softball can be found in *The Sports Rules Book: Essential Rules for 54 Sports* (1998), pp. 247–259.

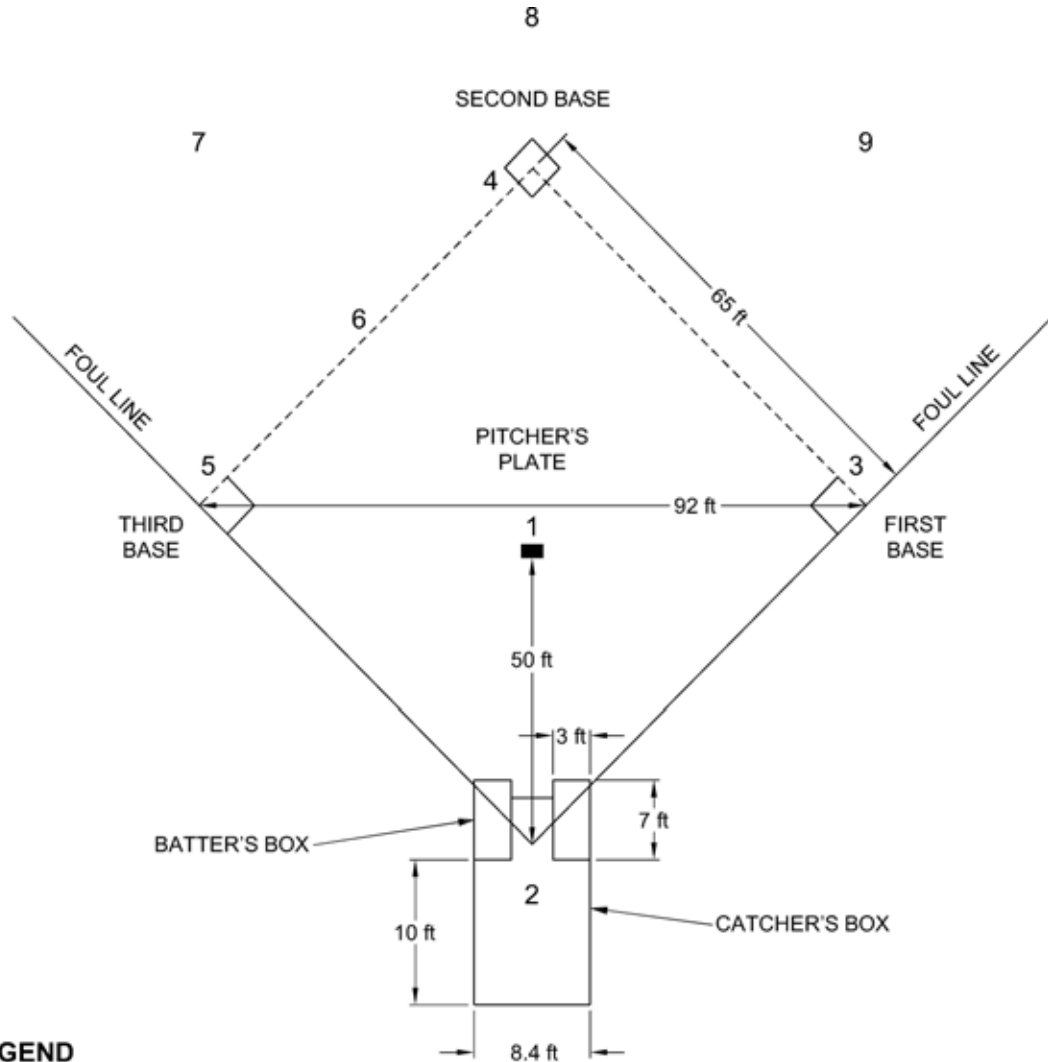

LEGEND

- 1. Pitcher
- 2. Catcher
- 3. First Baseman
- 4. Second Baseman
- 5. Third Baseman
- 6. Shortstop
- 7. Left Fielder
- 8. Centre Fielder
- 9. Right Fielder

Note. From *The Sports Rules Book: Essential Rules for 54 Sports* (p. 251), by T. Hanlon, 1998, USA: Human Kinetics Publishers, Inc. Copyright 1998 by Human Kinetics Publishers, Inc.

Figure Y-1 Softball Field

SOFTBALL SCORE SHEET

Team A

NAMES

Team B

NAMES

Record the number of runs scored by each team for each inning.

	Inning 1	Inning 2	Inning 3	Inning 4	Inning 5	Inning 6	Inning 7	TOTAL
Team A								
Team B								

Note. The scorekeeper must sign the back of the score sheet when completed.

ULTIMATE FRISBEE

OBJECTIVE

Teams attempt to score as many points as possible by catching a pass in the opponent's end zone. The team with the highest score at the end of the game is the winner. Ultimate Frisbee helps improve the cardiovascular and muscular strength components of fitness.

SCORING

Points are awarded to a team when a player catches a pass in the opponent's end zone. A typical game is scored to 15 points.

DEFINITIONS

Clearing. To get out of the area where the thrower wants to pass the Frisbee.

Cut. An attempt to get free of other players in order to receive a pass.

Force. To make it difficult for the thrower to throw the Frisbee in a certain direction in an attempt to try to get them to pass it the other way.

Huck. A long high pass that is nearly the length of the field.

Layout. When a player dives to catch or intercept the Frisbee.

Poach. When a defender moves away from their marker to try to intercept a pass to another player.

Swing. A lateral pass across the pitch, instead of upfield.

Switch. When two defenders exchange the offensive players they were marking.

NUMBER OF PLAYERS

Seven players per team on the field at one time.

EQUIPMENT

- One Frisbee, and
- Pylons to mark boundaries.

BASIC RULES

The game is played in two halves. There is no time set for the halves. Halftime begins when one team reaches eight points.

Each team lines up on the front of their respective end zone line to initiate play. The defence will then throw the Frisbee to the offence.

The Frisbee may be played in any direction by passing to teammates. Players must remain stationary when they hold the Frisbee. It must be passed to other players on the field that is closer to the opponent's end zone.

A player cannot hold the Frisbee for longer than 10 seconds. The defender, who is guarding the player holding the Frisbee (staller), must count out the stall count.

When a pass is not completed due to being out of bounds, being dropped, blocked or intercepted, etc. the defence takes possession of the Frisbee and becomes the offence.

To bring the Frisbee back into play it must be brought to the point on the pitch where it went out, or the nearest point where a defender touched it.

There is no physical contact allowed between the players.

A throw can be made without stopping if it is within three steps of the catch. The thrower cannot change direction or speed up after catching the Frisbee.

After halftime the teams will switch ends of the playing field.



Further details on the sport of ultimate Frisbee can be found at <http://www.whatisultimate.com> or <http://www.upa.org/ultimate>

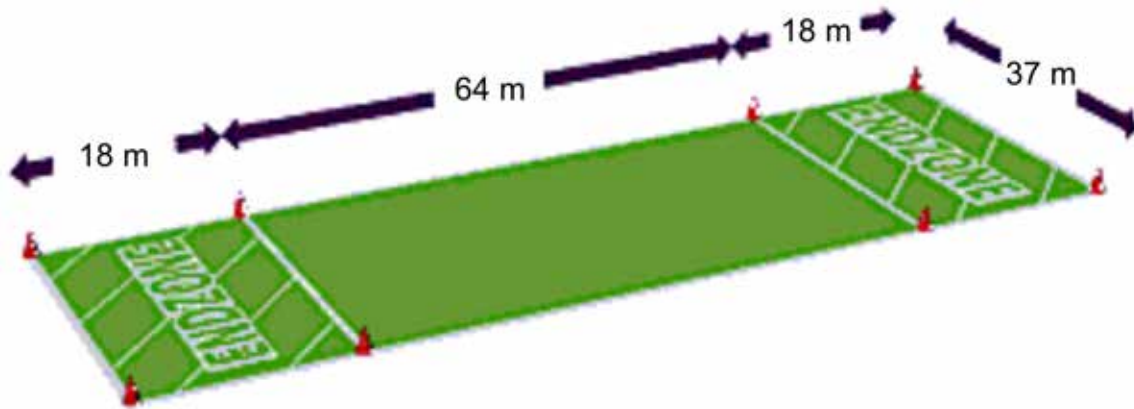

Note. From What is Ultimate Frisbee, by What is Ultimate, n.d. Retrieved October 30, 2006, from http://www.whatisultimate.com/what/what_game_en.html

Figure Z-1 Ultimate Frisbee Field

THIS PAGE INTENTIONALLY LEFT BLANK

VOLLEYBALL

OBJECTIVE

Teams attempt to score as many points as possible by hitting the ball into the opposing team's portion of the court. The team with the highest score at the end of the game is the winner. Volleyball helps improve the cardiovascular and muscular strength components of fitness.

SCORING

One point is awarded every time the ball hits inside the boundary lines of the opposing team's court; the opponents are unable to return the serve within three hits; the opponents hit the ball out of bounds; or the opponents commit a fault or foul when the team was the serving team.

DEFINITIONS

Attack hit. A hit aimed into the opponent's court.

Attack lines. These separate each side of the court into a front zone and a back zone.

Block. Occurs when one or more players stop the ball before, or just after, it crosses the net.

Rally. The exchange of hits back and forth between the teams. The team that wins the rally gets the serve.

Rotation order. Each team has a rotation order that must be kept when it gains the serve. Each time a team gains a serve; players will rotate one position clockwise.

NUMBER OF PLAYERS

Six players per team on the court at one time.

EQUIPMENT

- Volleyball,
- Volleyball net, and
- Volleyball court.

BASIC RULES

The game continues until a team scores 21 points in a rally format (a point is awarded on each play of the game regardless of which team serves the ball) and has a two-point advantage.

The team has three players on the front of the court and three on the back of the court.

Players can hit the ball with their hands clasped together or with either an open or closed fist. Players can strike the ball overhand or underhand.

One team will start the serving, the other receiving. A player retains the serve until the other team wins the right to serve.

Upon completing the serve a team must rotate positions.

The server may stand anywhere behind the end line to serve.

A service fault occurs if the ball touches a player of the serving team; fails to pass through the crossing space over the net; touches the net or any other object; or lands out of bounds.

If the team that is receiving stops their opponents from scoring, they are awarded the serve.

Each team has a maximum of three hits to get the ball over the net to return the ball. This is in addition to blocking.

Except on the serve, the ball is still in play if it touches the net.



Further details on the sport of volleyball can be found in *The Sports Rules Book: Essential Rules for 54 Sports* (1998), pp. 325–334.

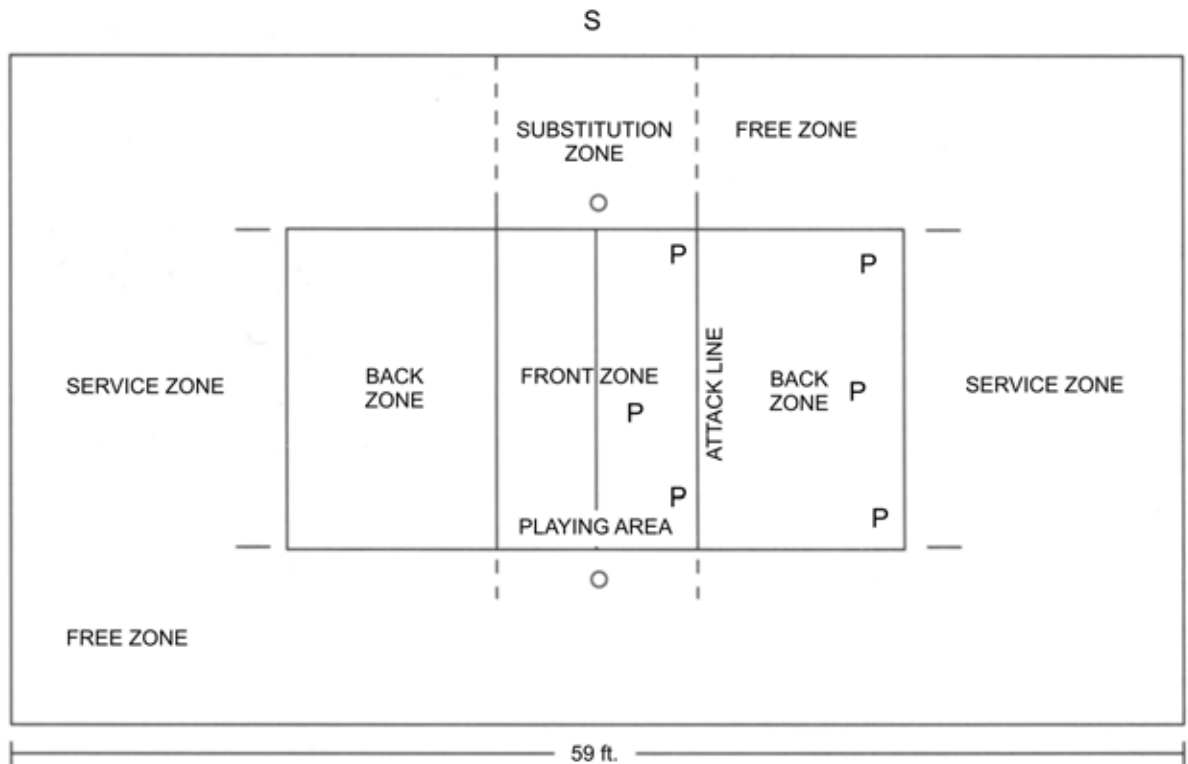

LEGEND

- P Player
- S Scorekeeper

Note. From The Sports Rules Book: Essential Rules for 54 Sports (p. 327), by T. Hanlon, 1998, USA: Human Kinetics Publishers, Inc. Copyright 1998 by Human Kinetics Publishers, Inc.

Figure AA-1 Volleyball Court

VOLLEYBALL SCORE SHEET

Team A

NAMES

Team B

NAMES

Check off each point as it is awarded to a team.

Points	1	2	3	4	5	6	7	8	9	10	11	12	13	14	15	16	17	18	19	20	21	
Team A																						
Team B																						

Note. The scorekeeper must sign the back of the score sheet when completed.

ACTIVE GAMES

INTRODUCTION

Active games are a great way of incorporating multiple components of fitness. These physical activities make fitness fun and can spark an interest in maintaining lifelong fitness. Active games help improve various components of fitness depending on the selected game.

EQUIPMENT

The equipment required for these games will depend on which game is selected.

ACTIVITY GUIDELINES

Active games shall be well supervised.

Active games shall be conducted in a large training area or playing field that is free of obstructions.

Cadets shall wear appropriate physical activity clothing and footwear for this activity.

SUGGESTED ACTIVE GAMES

Battleship

This is a nautical themed active game where the playing area is broken down into different parts of a ship, to include:

- **Bow.** The front of the playing area,
- **Stern.** The back of the playing area,
- **Port.** The left side of the playing area, and
- **Starboard.** The right side of the playing area.

There are special actions to be completed when called during the game, such as:

- **Submarines.** Cadets run to the centre of the playing area, lie down on their back, and raise one foot in the air.
- **Lifeboats Port.** Cadets run to the left side of the playing area, form a single line, sit down and begin to row.
- **Lifeboats Starboard.** Cadets run to the right side of the playing area, form single line, sit down and begin to row.

1. Begin the game with the cadets standing in the centre of the area.
2. Have the leader call one of the above parts of the ship or special action.
3. Have the cadets run to the designated area or perform the special action.
4. Eliminate the last cadet to reach the designated spot or perform the special action, and have them move to help the leader.
5. Continue until a winner is designated.

Cardio Blob Tag

A fast-paced game using two pool noodles where cadets must move or be swallowed by the “blob”.

1. Designate one cadet as the “blob”.
2. Have the “blob” carry a pool noodle to use to tag other cadets (below the shoulders).
3. Have the first tagged cadet join hands with the “blob” and give them the other pool noodle.
4. Ensure that the two cadets making the “blob” always remain joined (holding hands) and move throughout the group tagging other cadets.
5. Have any newly tagged cadets join the “blob” by holding hands with the cadet who tagged them and taking the pool noodle.
6. Allow the “blob” to grow until all the cadets have joined the “blob”.

Tag

There are many variations of tag games, such as cardio blob tag, everybody’s it, and frozen tag. These types of games begin with one or more cadets being designated as “it”. The “it” cadets must run and tag (touch) other cadets to either make them it, freeze them, or add them to the blob. There are many online resources and books for tag games. Select tag games that maximize movement and keep the cadets’ heart rates up.

SUGGESTED RESOURCES

Ultimate camp resource. (n.d.). *Camp games*. Retrieved October 6, 2011, from <http://www.ultimatecampresource.com/site/camp-activities/camp-games.html>

ISBN 0-934387-29-X Panicucci, J. (2008). *Achieving fitness: An adventure activity guide*. Beverly, MA: Project Adventure, Inc.

CIRCUIT TRAINING

INTRODUCTION

Circuit training was developed in the late 1950s at the University of Leeds in England. Circuit training consists of a number of carefully selected and simple-to-perform exercises in a set order called the "circuit". Each exercise is performed in turn, either a set number of times or within a set time period (usually 30–60 seconds), after a brief recovery period. A rotation through all stations is a circuit. The circuit is normally repeated three times.

Timed circuit training allows the activity to be conducted within a specific time limit. They also prevent waiting at exercise stations. They allow each individual to develop their fitness level at their own pace. Circuits that are not timed must be conducted using the maximum number of repetitions that can be done continuously without setting a specific time limit.

Circuit training may be adapted to focus on any component of fitness and may also be used to practice and improve various sports skills.

EQUIPMENT

Circuit training equipment, based on the stations selected.

ACTIVITY GUIDELINES

Circuits shall be designed based on activities and exercises that are appropriate for cadets. Many of the activities and exercises listed in this instructional guide may be used as stations in a circuit (eg, skipping rope and weighted bar exercises).

CIRCUIT DESIGN

When designing a circuit, the following should be considered:

- Exercises in a circuit may focus on cardiovascular endurance (eg, skipping rope), muscular strength (eg, medicine balls), muscular flexibility (eg, stretching), or a combination of them.
- Exercises must be arranged in an order so that no group of muscles is worked consecutively.
- Each station should have enough equipment for all cadets at that station to participate at once.
- When at a recovery station, the cadets must keep walking, jogging or moving around. They should also drink water.
- The number of activities chosen depends on the time allocated to complete the circuit.

Sample General Circuit Training

Each station will last 45 seconds.

<p>Station 1: Cardiovascular Endurance</p> <p>Exercise: Rope skipping Equipment: 6 skipping ropes</p>	<p>Station 2: Recovery</p> <p>Exercise: Jog on the spot Equipment: Nil.</p>	<p>Station 3: Muscular Strength</p> <p>Exercise: Curl-ups Equipment: Gym mats</p>
<p>Station 12: Recovery</p> <p>Exercise: Walk around the circuit Equipment: Nil.</p>	<p>INSTRUCTOR</p>	<p>Station 4: Recovery</p> <p>Exercise: Walk around the circuit Equipment: Nil.</p>
<p>Station 11: Muscular Strength</p> <p>Exercise: Squat thrusts Equipment: Nil.</p>		<p>Station 5: Muscular Flexibility</p> <p>Exercise: Spine twist stretch Equipment: 2 benches</p>
<p>Station 10: Recovery</p> <p>Exercise: Jog on the spot Equipment: Nil.</p>		<p>Station 6: Recovery</p> <p>Exercise: Jog on the spot Equipment: Nil.</p>
<p>Station 9: Muscular Flexibility</p> <p>Exercise: Knee to chest stretch Equipment: Gym mats</p>		<p>Station 7: Cardiovascular Endurance</p> <p>Exercise: Jumping jacks Equipment: Nil.</p>
	<p>Station 8: Recovery</p> <p>Exercise: Walk around the circuit Equipment: Nil.</p>	

SUGGESTED RESOURCES

ISBN 978-0-7360-8118-4 Carpenter, J. & Sinclair, C. Eds. (2011). *Physical best activity guide: Middle and high school levels*, 3rd edition. Windsor, ON: National Association for Sport and Physical Education.

MARTIAL ARTS

INTRODUCTION

Martial arts combine multiple components of fitness, including cardiovascular, muscular strength and muscular flexibility, into a fun, disciplined physical activity.

EQUIPMENT

The equipment required will depend on the selected type of martial arts.

ACTIVITY GUIDELINES

Martial arts shall be conducted by a certified instructor or using a video that is conducted by a certified instructor.

TYPES OF MARTIAL ARTS

Aikido. A Japanese form of self defense that uses wrist, joint and elbow grips to disable an opponent.

Kick Boxing. A martial art that resembles boxing but allows the use of the feet.

Judo. A method of defending oneself without the use of weapons. This method stresses the athletic component of this martial art.

Jiujutsu. A method developed in Japan for defending oneself using the strength and weight of an opponent to disable them.

SUGGESTED RESOURCES

Jeanette Jenkins, Certified by the Thai Boxing Association of Canada. *Crunch: Super-charged kickbox party.* 2007. [DVD]

ISBN 0-8048-3284-6 Westbrook, A. & Ratti, O. (1970). *Aikido and the dynamic sphere: An illustrated introduction.* North Clarendon, VT: Charle E. Tuddle Co., Inc.

THIS PAGE INTENTIONALLY LEFT BLANK

TABLOIDS

INTRODUCTION

Tabloid meets consist of various small, easy to play games or relay events. Tabloid meets are a fun way to be active and cover multiple components of fitness in one activity.

Tabloid meets have numerous advantages:

- a large number of personnel can participate at the same time;
- a wide variety of activities can be conducted;
- can be planned around existing facilities and equipment; and
- emphasis can be placed on team effort rather than on high-calibre performance by a small number of individuals.

Tabloid meets are intended for the cadets to work as a team, communicate, cooperate and have fun.

EQUIPMENT

The equipment required for tabloids will depend on which events are selected.

ACTIVITY GUIDELINES

The size of the group, the number of staff, the time allocated for the meet, the facilities and the equipment are factors that will affect the events, the group sizes, the time allocated at each event and the overall design of the meet. When designing a tabloid, ensure that the selected events are energetic and promote physical activity.

In a tabloid meet, the cadets must rotate through events in a pre-arranged fashion. A diagram of the stations can be displayed or signs with station numbers can be placed at each station.

Size of the Group

The size of the group will determine the number of events required. For example:

- If there are 60 cadets and the organizer wants them in teams of five, there should be at least 12 events (if there is only one team / event) or six events (if there are two teams / event).
- If there are 30 cadets and the organizer wants them in teams of three, there should be at least 10 events (if there is only one team / event) or five events (if there are two teams / event).

Number of Staff

The number of staff available to run the event may affect the number of events. Many personnel may be involved in a novelty events tabloid meet, such as:

- master scorekeeper,
- timekeeper,
- official for each event,
- first-aider, and / or
- runners (could be cadets from each team who bring the results to the master scorekeeper after each event).

Each event is controlled by one official who remains at the event throughout the meet. Their duty is to ensure safety and that the competitors observe the rules. After each event is completed, the official will fill out the scoresheet and send it to the master scorekeeper's table.

The master scorekeeper transfers the information from the team scoresheet to the master scoresheet.

Time Allocated For The Meet

Time allocated for the meet has to take into account the set-up, warm-up, cool-down, tear down, and award ceremony (if applicable).

Events should be planned so they take the same amount of time to be completed. This maintains control of the meet and ensures that all teams are at the same stage of the event.

Facilities

The facilities may offer a variety of events or put restrictions on them (eg, when using a school gym, it may be forbidden to bring food or particular items that could damage the floor).

Sample Tabloid Events

Examples of typical events are as follows:

Events	Description
Accuracy Throw	Each team member has to toss a beanbag or similar item into a ring of concentric circles with various point values. This continues until the time has elapsed.
Ball Over and Under	The team forms a single file line. The first person passes the ball over their head to the next person who then passes the ball between their legs to the next person. This continues to the last member who then runs to the front and starts again.
Basketball Throw	Each team member has to throw a basketball into the net from a specific point. This continues until the time has lapsed.
Skipping	Each team member has to skip with a jump rope as many times as they can without stopping.
Volleyball Bump	The team stands in a circle and a volleyball is bumped from person to person continuously without it touching the floor until the time has lapsed.

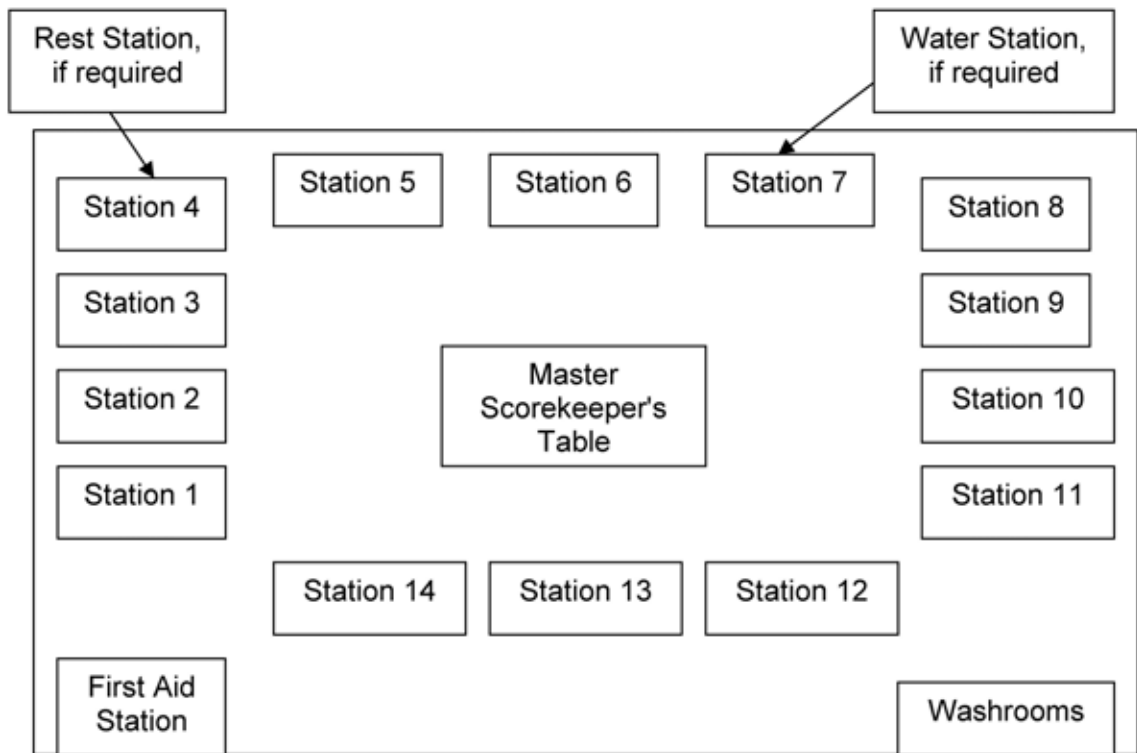

Figure AE-1 Layout of a Tabloid Meet

SUGGESTED RESOURCES

A-PD-050-015/PT-002 Directorate of Physical Education, Recreation and Amenities. (1989). *Physical fitness training in the Canadian Forces* (Vol. 2). Ottawa, ON: Department of National Defence.

The Canadian Association for Health, Physical Education, Recreation and Dance. (1983). *Basic skills series: Tabloid sports*. Calgary, AB: The Canadian Association for Health, Physical Education, Recreation and Dance.

THIS PAGE INTENTIONALLY LEFT BLANK



**COMMON TRAINING
ALL TRAINING LEVELS
INSTRUCTIONAL GUIDE
PHYSICAL ACTIVITIES**



SECTION 2

EO CX05.01 – PARTICIPATE IN PHYSICAL ACTIVITIES

Total Time:

9 x 30 min

THERE IS NO INSTRUCTIONAL GUIDE PROVIDED FOR THIS EO. REFER TO THE INSTRUCTIONAL GUIDE FOR EO MX05.01 (PARTICIPATE IN PHYSICAL ACTIVITIES).

THIS PAGE INTENTIONALLY LEFT BLANK



**COMMON TRAINING
ALL TRAINING LEVELS
INSTRUCTIONAL GUIDE
PHYSICAL ACTIVITIES**



SECTION 3

EO CX05.02 – PARTICIPATE IN A TOURNAMENT

Total Time:

9 x 30 min

PREPARATION

PRE-LESSON INSTRUCTIONS

This IG supports EO CX05.02 (Participate in a Tournament) located in A-CR-CCP-701/PG-001, *Green Star, Qualification Standard and Plan*, Chapter 4.

Refer to EO MX05.01 (Participate in Physical Activities) for a list of sports to select from and rules associated with each.

Refer to the warm-up and the cool-down located at Annexes A and B of EO MX04.01 (Participate in 60 Minutes of Moderate- to Vigorous-Intensity Physical Activity and Track Participation in Physical Activities).

Select a tournament and refer to the following attachments for an overview of how to conduct the selected tournament:

- Attachment A–Round Robin,
- Attachment B–Ladder,
- Attachment C–Pyramid,
- Attachment D–Single Elimination, and
- Attachment E–Double Elimination.

PRE-LESSON ASSIGNMENT

Nil.

APPROACH

A practical activity was chosen for this lesson as it allows the cadets to participate in a tournament in a safe and controlled environment.

INTRODUCTION

REVIEW

Nil.

OBJECTIVES

By the end of this lesson the cadet shall have participated in a tournament.

IMPORTANCE

It is important for cadets to participate in a tournament because it is an activity that promotes camaraderie and a healthy lifestyle, while meeting the Cadet Program aim.

Teaching Point 1**Have the cadets participate in a tournament.**

Time: 9 x 30 min

Method: Practical Activity

BACKGROUND KNOWLEDGE

THE WARM-UP**Purpose of a Warm-Up**

A warm-up session is composed of light cardiovascular activities and stretches designed to:

- gradually increase respiratory action and heart rate;
- raise the muscle temperature to facilitate reactions in muscle tissue; and
- stretch the muscles.

This part of the warm-up prepares the cardiovascular system for the physical activity. It is composed of activities such as brisk walking, light jogging, or simple games that elevate the heart rate. As a guide, allow 10 minutes to warm up for every hour of physical activity.

THE COOL-DOWN**Purpose of a Cool-Down**

A cool-down is composed of light cardiovascular activities and stretches designed to:

- allow the body time to slowly recover from physical activity and to help prevent injury;
- prepare the respiratory system to return to its normal state; and
- stretch the muscles to help relax and restore them to their resting length.

Guidelines for Stretching

The following guidelines should be followed while stretching:

- Stretch all major muscle groups, including the back, chest, legs, and shoulders.
- Never bounce while stretching.
- Hold each stretch for 10–30 seconds to let the muscles release fully.
- Repeat each stretch two to three times.
- When holding a stretch, support the limb at the joint.

ACTIVITY

OBJECTIVE

The objective of this activity is to provide cadets the opportunity to participate in a tournament.

RESOURCES

- Sports / safety equipment required for the selected sport,
- First aid kit,

- Whistles,
- Stopwatch, and
- Schedule of competition.

ACTIVITY LAYOUT

Set up the training area for the selected sport.

ACTIVITY INSTRUCTIONS

1. Have the cadets participate in an introductory briefing, to include:
 - (a) an overview of the sport(s) that will be played during the tournament,
 - (b) type of tournament,
 - (c) rules of the tournament,
 - (d) organization of the draw, and
 - (e) location of first aid post.
2. Have the cadets participate in a warm-up session composed of light cardiovascular activities and stretches.
3. Have the cadets participate in the selected tournament.
4. Have the cadets participate in a cool-down session composed of light cardiovascular activities and stretches.

SAFETY

- Ensure cadets are aware of the rules and regulations.
- Ensure constant supervision throughout the activity.
- Ensure a first aid station / kit is readily accessible.
- Ensure a first-aider is identified at the start of the activity and is available at all times.

CONFIRMATION OF TEACHING POINT 1

The cadets' participation in the tournament will serve as the confirmation of this TP.

END OF LESSON CONFIRMATION

The cadets' participation in the tournament will serve as the confirmation of this lesson.

CONCLUSION

HOMEWORK / READING / PRACTICE

Nil.

METHOD OF EVALUATION

Nil.

CLOSING STATEMENT

Tournaments are fun activities that promote physical fitness, which is part of the aim of the Cadet Program. Participating in physical activities can help you:

- improve your health;
- do better in school;
- improve your fitness;
- grow stronger;
- have fun being active with friends;
- feel happier;
- maintain a healthy body weight;
- improve your self-confidence; and
- learn new skills.

INSTRUCTOR NOTES / REMARKS

Activities chosen for this training are not limited to the list presented but must be age appropriate.

Activities should be chosen based on equipment and facilities accessible to the corps / squadron.

REFERENCES

A0-050 A-PD-050-015/PT-002 Directorate of Physical Education, Recreation and Amenities. (1989). *Physical fitness training in the Canadian Forces* (Vol. 2). Ottawa, ON: Department of National Defence.

C0-187 San Diego County Office of Education. *After school physical activity: Types of tournaments*. Retrieved October 3, 2008, from <http://www.afterschoolpa.com/print/typesoftournaments.html>

THIS PAGE INTENTIONALLY LEFT BLANK

ROUND ROBIN TOURNAMENT

Recommended Use for a Round Robin Tournament

Round robin tournaments are best for league play or one-day tournaments that guarantee a certain number of games. All participants / teams play each other at least once. If there are a large number of participants / teams, a second, third or even fourth pool may be used.



Pool. A group of contestants who compete against each other in a tournament for the right to advance.

The number of courts or fields usually determines the number of pools. This is easy for participants / teams because they play all their games in the same location. The participants / teams may be used as referees, scorekeepers and linesmen during the round robin tournament.

The smaller the number of participants / teams in the pool, the shorter time it takes to complete the pool. Four to six participants / teams per pool are best.

To ensure fairness is shown to participants / teams, when making the pool, names should be chosen randomly (eg, pull the names out of a hat) and placed in the draw.

When using a round robin for a one-day tournament it may be combined with a single elimination tournament. The pool winners and runners-up may fill out a single elimination bracket. These participants / teams will play for the championship.

A tiebreaker system may be put in place before the start of the tournament (eg, points for versus points against).

Sample Draws

To arrange the rounds and the game schedule for an event for an even number of entries, keep the first entry constant and rotate the remaining as follows:

Round 1	Round 2	Round 3	Round 4	Round 5	Round 6	Round 7
1 - 8	1 - 2	1 - 3	1 - 4	1 - 5	1 - 6	1 - 7
2 - 7	3 - 8	4 - 2	5 - 3	6 - 4	7 - 5	8 - 6
3 - 6	4 - 7	5 - 8	6 - 2	7 - 3	8 - 4	2 - 5
4 - 5	5 - 6	6 - 7	7 - 8	8 - 2	2 - 3	3 - 4

Note. Created by Director Cadets 3, 2007, Ottawa, ON: Department of National Defence.

Figure A-1 Robin Draw With an Even Number of Participants



Bye. A term used when a participant / team moves into the next round of competition without participating in the previous round due to an uneven number of teams.

THIS PAGE INTENTIONALLY LEFT BLANK

LADDER TOURNAMENT

Recommended Use for a Ladder Tournament

The ladder tournament is the most popular form of extended tournaments (eg, racquet clubs, league play). It is best with pairs or individual participants such as racquet sports. Ladders may be created by ability grouping (eg, beginner, intermediate or advanced). Players / teams challenge the player / team above them on the ladder.

If the challenger wins, they exchange places on the ladder with the loser. If the challenger loses the competition, they stay where they are on the ladder.

Even though the tournament coordinator may modify the rules to suit the nature of the competition, possible rules for planning a ladder tournament are:

- Each contestant is permitted to challenge the player immediately above him / her, or up to two or three above.
- Provided the player challenged is not already involved in a previous challenge, he / she must accept the invitation within a given period.
- If the challenger wins, or the challenge is not accepted, the positions on the board are switched.

Challenges must be accepted and played within a certain time limit, usually one week. If a participant / team does not challenge within the time limit, they move down the ladder. Usually participants / teams are not allowed to challenge the same participant / team twice in a row.

Sample Draw

To ensure fairness is shown to participants / teams, when making the pool, names should be chosen randomly (eg, pull the names out of a hat).

If the number of entries to a ladder tournament is large, more than one ladder may be used. A player wishing to enter the competition late must challenge the player at the bottom of the lowest ladder.

Upon reaching the top of the ladder, a contestant may challenge the player at the bottom of the next higher ladder.

A winner of a ladder tournament may be declared on a set date, or the tournament may continue until the participants / teams decide that the tournament is over (eg, the participant / team at the top of the ladder cannot be beaten).

Byes

There are no byes in a ladder tournament.

A- DIVISION LADDER

K
B
A
D
E
C
J
F
H
G

B- DIVISION LADDER

c
d
b
a
f
j
e
h
k
g

(NEW ENTRY)

Note. Created by Director Cadets 3, 2007, Ottawa, ON: Department of National Defence.

Figure B-1 Ladder Draw

PYRAMID TOURNAMENT

Recommended Use for a Pyramid Tournament

The pyramid tournament is a popular form of an extended tournament (eg, racquet clubs, league play). A pyramid tournament is similar to a ladder tournament, but the board is in the form of a pyramid, with one participant / team at the top, two in the next row, three in the next, and so on. It is best with pairs or individual participants such as racquet sports. Players / teams challenge the player / team above them on the pyramid. A pyramid tournament gives participants / teams greater opportunity to challenge opponents because the step above them has more participants / teams listed.

If the challenger wins, they exchange places on the pyramid with the loser. If the challenger loses the competition, they stay where they are on the pyramid.

Challenges must be accepted and played within a certain time limit, usually one week. If a participant / team does not challenge within the time limit, they move down the pyramid. Usually participants / teams are not allowed to challenge the same participant / team twice in a row.

Sample Draw

To ensure fairness is shown to participants / teams, when making the pool, names should be chosen randomly (eg, pull the names out of a hat).

A winner of a pyramid tournament may be declared on a set date decided by the organizer, or the tournament may continue until the participants / teams decide that the tournament is over (eg, the participant / team at the top of the pyramid cannot be beaten).

Byes

There are no byes in a pyramid tournament.

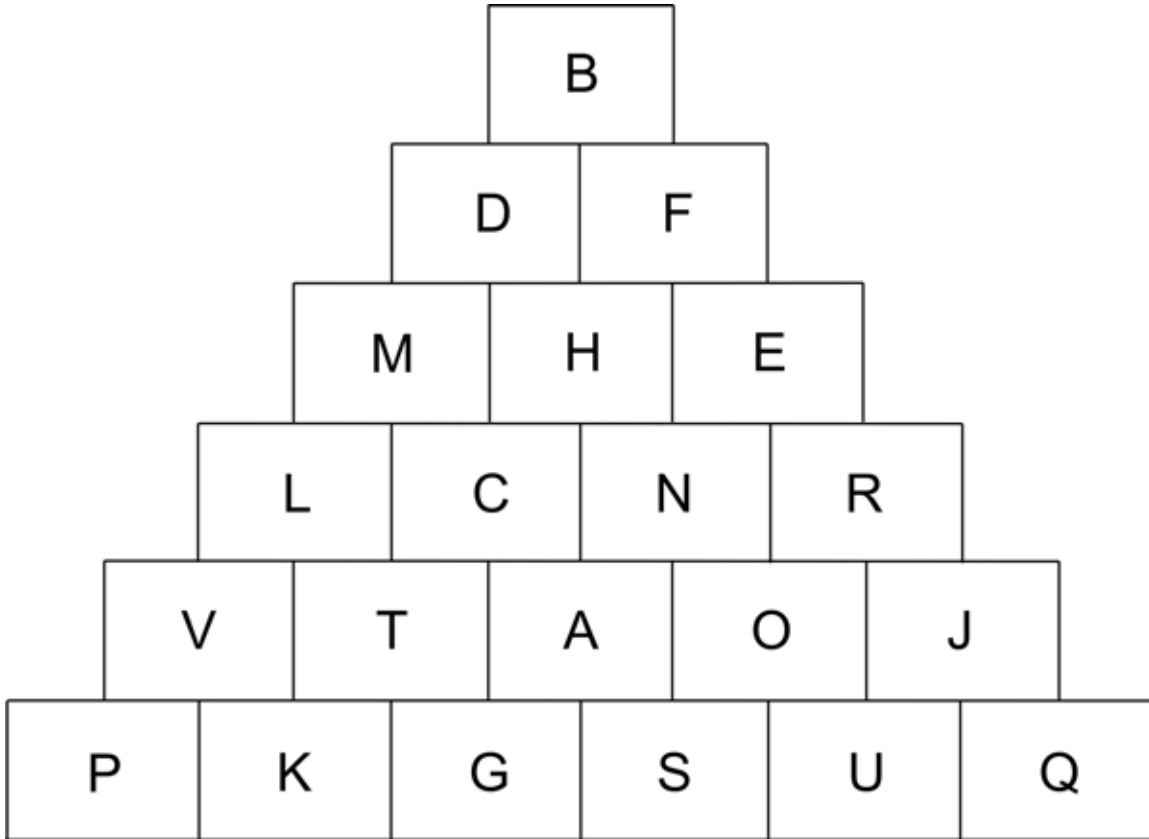

Note. Created by Director Cadets 3, 2007, Ottawa, ON: Department of National Defence.

Figure C-1 Pyramid Draw

SINGLE ELIMINATION TOURNAMENT

Recommended Use for a Single Elimination Tournament

The single elimination tournament is best used when there are a large number of entries, a short period of time and a limited number of courts / fields. It is the easiest of all tournaments to run. When participants / teams win, they continue to play. When participants / teams lose, they are eliminated from the tournament.

If there are a large number of participants / teams, multiple single elimination tournaments may be used. Participants / teams may be divided into skill levels (eg, beginner, intermediate and advanced) as three separate tournaments. This is a good format to use at the end of a round robin tournament with more than one pool, to determine an overall winner.

Sample Draws

To ensure fairness is shown to participants / teams, when making the pool, names should be chosen randomly (eg, pull the names out of a hat).

The maximum number of games to be played is equal to the number of entries minus one. If there are 12 players or teams, 11 games will be necessary to determine the winner.

The number of entries in Round 2 and subsequent rounds is always a power of 2 through the use of byes during Round 1.

Seeded Players

This term refers to outstanding players or teams who are placed in the draw in positions where they should, assuming they win all their matches, meet in the quarter or semifinals. The intent is to prevent the top competitors from meeting in the early rounds. There should be no more than 2 seeds to every 16 entries.

When seeded players are present (eg, when using a round robin combined with a single elimination tournament), the seeded players should be placed in the draw in positions where they should not meet before the quarters or semifinals.

Byes

A bye occurs in the single or double elimination competition when the number of entries is not a power of 2 (eg, 2, 4, 8, 16, 32).

When the number of entry is not a power of two, it is necessary to have a number of byes. All byes must be given in the first series so that the number of entries remaining in the subsequent series is always a power of 2.

When calculating the number of byes, the number of entries is subtracted from the next highest power of 2.

Number of participants / teams	Next highest power of 2	Calculation	Number of byes
2		Power of 2, so there are no byes.	
3	4	$4 - 3 = 1$	1
4		Power of 2, so there are no byes.	
5	8	$8 - 5 = 3$	3
6	8	$8 - 6 = 2$	2
7	8	$8 - 7 = 1$	1
8		Power of 2, so there are no byes.	
9	16	$16 - 9 = 7$	7
10	16	$16 - 10 = 6$	6
11	16	$16 - 11 = 5$	5
12	16	$16 - 12 = 4$	4
13	16	$16 - 13 = 3$	3
14	16	$16 - 14 = 2$	2
15	16	$16 - 15 = 1$	1
16		Power of 2, so there are no byes.	
17	32	$32 - 17 = 15$	15
18	32	$32 - 18 = 14$	14
19	32	$32 - 19 = 13$	13
20	32	$32 - 20 = 12$	12
21	32	$32 - 21 = 11$	11
22	32	$32 - 22 = 10$	10
23	32	$32 - 23 = 9$	9
24	32	$32 - 24 = 8$	8
25	32	$32 - 25 = 7$	7
26	32	$32 - 26 = 6$	6
27	32	$32 - 27 = 5$	5
28	32	$32 - 28 = 4$	4
29	32	$32 - 29 = 3$	3
30	32	$32 - 30 = 2$	2
31	32	$32 - 31 = 1$	1
32		Power of 2, so there are no byes.	

Note. Created by Director Cadets 3, 2008, Ottawa, ON: Department of National Defence.

Figure D-1 Byes Required in a Single or Double Elimination Tournament

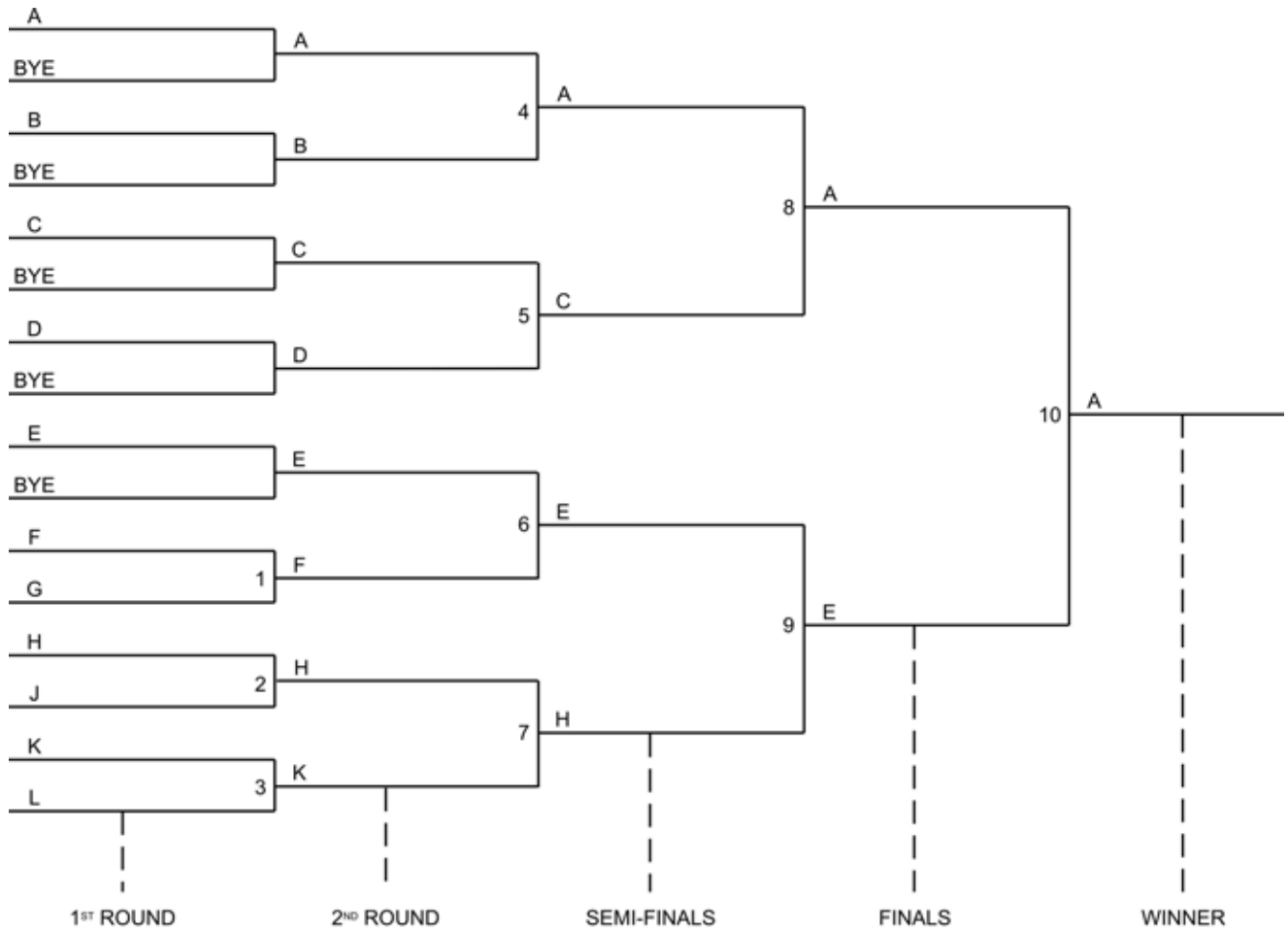

NOTES:

1. For eleven entries there are ten games (11-1) and five byes (16-11).
2. Letters denote advancing teams.
3. Numerals denote the order in which the games are played.

Note. From Physical Fitness Training in the Canadian Forces (Vol. 2) (p. 4-40) by Directorate of Physical Education, Recreation and Amenities, 1989, Ottawa, ON: Department of National Defence.

Figure D-2 Single Elimination Draw

THIS PAGE INTENTIONALLY LEFT BLANK

DOUBLE ELIMINATION TOURNAMENT

Recommended Use for a Double Elimination Tournament

This is very similar to the single elimination tournament with the major difference being that each participant / team must lose two games before being eliminated. This means that the tournament takes more time to conduct.

After their first loss, the participant / team is transferred to the left side of the bracket, where they are eliminated after the second defeat. In the finals, the winner of the left side (loser's bracket) meets the winner of the right side (winner's bracket). If the winner of the loser's bracket should defeat the winner of the winner's bracket, an additional game is required. After the completion of the second game, the participant / team that has suffered two defeats is eliminated and the other participant / team is declared the winner.

Sample Draws

The maximum number of games to be played is equal to double the number of entries minus one. If there are 12 teams or participants, 23 games would be the maximum number of games to be played ($12 \times 2 - 1 = 24 - 1 = 23$).

A double elimination tournament is not advisable when more than 10 teams are part of the event. The winner on the loser's side would be involved in too many games before the championship can be decided.

Seeded Players

If seeded players are competing, they should be placed in each section of the draw so that they may be expected to reach quarter or semifinals without meeting a seeded player. The remaining positions can be drawn randomly out of a hat.

Byes

If the number of entries is not a perfect power of 2, byes will be required.

All byes must be given in the first series so that the number of entries remaining in the subsequent series is always a power of 2. The byes should be divided evenly between the top and bottom halves.

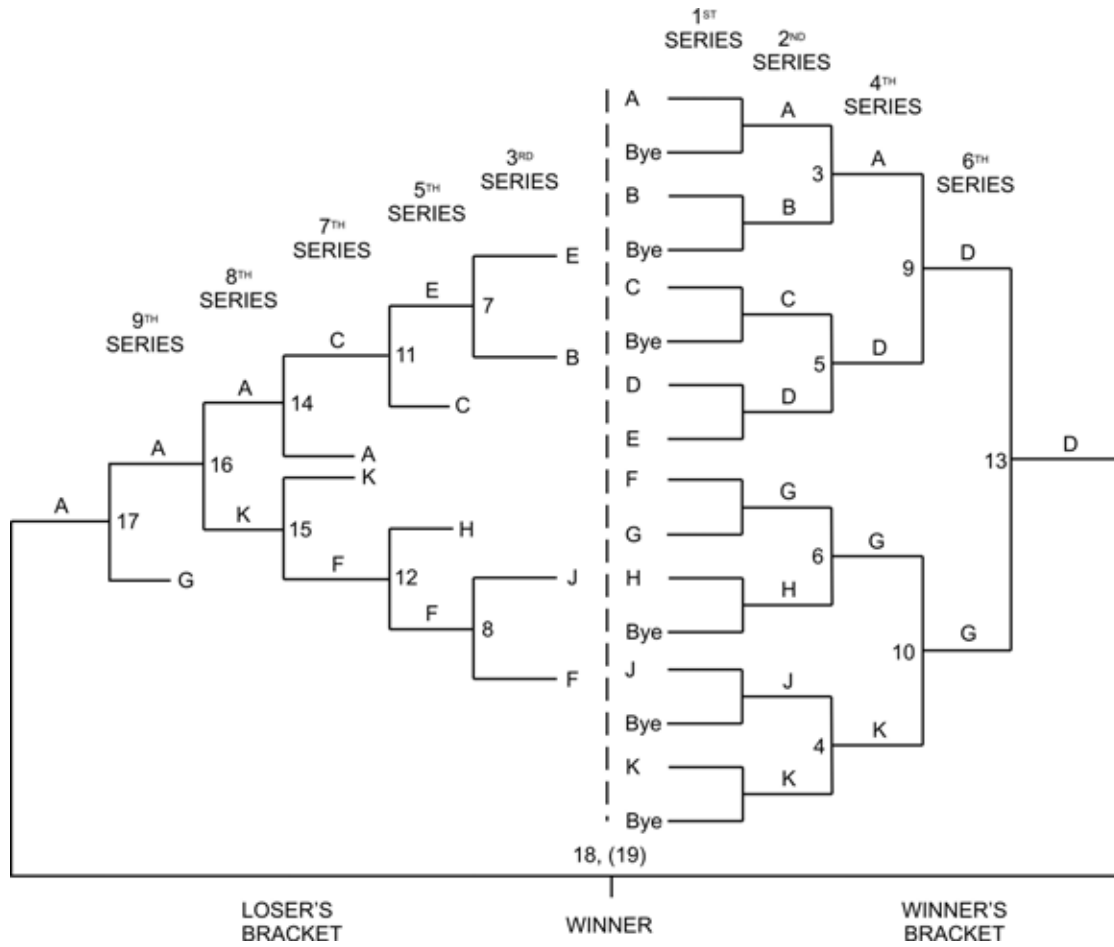

Note. From *Physical Fitness Training in the Canadian Forces (Vol. 2)* (p. 4-40) by Directorate of Physical Education, Recreation and Amenities, 1989, Ottawa, ON: Department of National Defence.

Figure E-1 Double Elimination Draw

CHAPTER 6
PO 106 – FIRE THE CADET AIR RIFLE



**COMMON TRAINING
GREEN STAR
INSTRUCTIONAL GUIDE**



SECTION 1

EO M106.01 – IDENTIFY THE PARTS AND CHARACTERISTICS OF THE DAISY 853C AIR RIFLE

Total Time:

30 min

PREPARATION

PRE-LESSON INSTRUCTIONS

Resources needed for the delivery of this lesson are listed in the lesson specification located in A-CR-CCP-701/PG-001, *Green Star Qualification Standard and Plan*, Chapter 4. Specific uses for said resources are identified throughout the instructional guide within the TP for which they are required.

Prior to instructing this lesson the instructor shall:

- review the lesson content, and become familiar with the material;
- carry out a safety precaution check on all rifles to be used during this lesson; and
- state to cadets that the rifles have been inspected and are safe to handle.

PRE-LESSON ASSIGNMENT

Nil.

APPROACH

An interactive lecture was chosen for this lesson to orient the cadets to the parts and characteristics of the Daisy 853C Air rifle and generate interest.

INTRODUCTION

REVIEW

Nil.

OBJECTIVES

By the end of this lesson the cadet shall be expected to identify the parts, and list the characteristics of the cadet air rifle.

IMPORTANCE

Cadets must have a basic knowledge of the cadet air rifle in order to understand how the rifle works and to safely follow directions given on the range.

Teaching Point 1**Identify the parts of the Daisy 853C air rifle.**

Time: 13 min

Method: Interactive Lecture

PARTS

- Depending on the number of rifles available, distribute them with an optimum ratio of one rifle for every two cadets.
- When possible, have a second instructor in the room to assist.
- **For safety purposes, maintain strict class control at all times.**

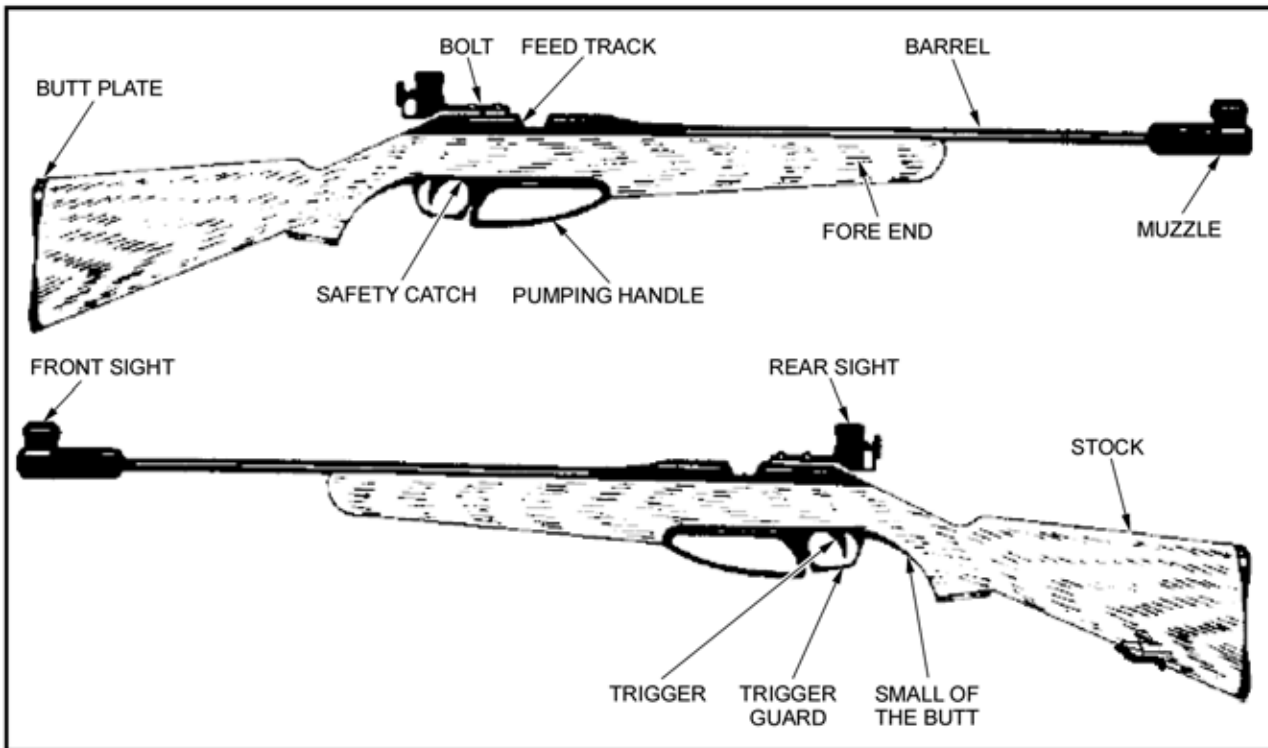

A-CR-CCP-177/PT-001

Figure 1 Parts of the Cadet Air Rifle

Butt Plate (End of the Butt). It is the part of the rifle directly in contact with the marksman's shoulder. When fitted properly, the butt plate aids in achieving a snug fit, and a consistent placement of the rifle into the shoulder. The addition of butt spacers allows for this adjustment in length.

Spacers. Plastic inserts that can be added or removed from the butt plate to vary its length. To add or take away butt spacers, use a Phillips screwdriver to loosen the butt plate and slide in/out the amount of spacers desired.

Small of the Butt (Pistol Grip). Curved area directly behind the trigger guard where the hand controlling the trigger grips the rifle.

Stock. Complete wooden portion of the rifle (from the butt plate end forward).

Fore End (of the Stock). Wooden portion of the stock from the trigger guard forward, in which the barrel and the rifle mechanism are encased.

Sling. It is a web sling made of nylon. Links the rifle to the marksman's arm to support most of the weight of the rifle. One end attaches to the sling bracket and the other to the upper arm.

Sling Bracket (Hand Stop). Adjustable metal clasp attached to the fore stock used to affix the sling to the rifle. It also acts as a hand stop, used to rest the left hand to prevent it from moving.

Trigger. Movable device that releases a spring and releases the rifle mechanism. This rifle has a single stage trigger that cannot be adjusted for weight.

Trigger Guard. Metal band that surrounds and protects the trigger.

Safety Catch. This is a mechanism that, once engaged, prevents the rifle from firing by locking the trigger in place. It is a cross bolt type device located on the trigger guard. The black side indicates that the rifle is unable to fire; the red side indicates the rifle is ready to fire. It should be ON (no red) at all times, unless firing.

Bolt. Metal lever used for opening or closing the rifle mechanism. It must be in the closed position in order to fire. For maximum safety when the rifle is uncased and not firing, the bolt should be kept open.

Pump Handle. Metal lever used to compress the air required to fire the pellet. Whenever the rifle is in a "safe rifle status", the pump lever should be left partially open.

Front Sight. Global front sight that uses aperture inserts.

Rear Sight. Micrometer sight adjustable for windage and elevation. It is easily attached to a metal rail located above the action. This rail allows for adjustment of the sight forward or backward, in order to maintain proper eye relief. The sight is attached using a small flat-blade screwdriver.

Muzzle. Front end of the barrel equipped with attachable barrel weight.

Barrel With Barrel Weight. Steel tube through which the pellet travels, extending from the muzzle to the chamber. The barrel weight ensures that the rifle's weight is evenly distributed and that the rifle's balance is maintained.

Bore. Interior of the barrel has spiral grooves cut into it. The lands are the ridges of metal between the grooves. Together, the grooves and lands are called rifling.

Feed Track. Delicate area where the pellet is inserted manually onto a single pellet adapter, or with a five-shot clip.

Single Shot Adapter. Plastic clip that aids in placing a pellet in the chamber.

Five-shot Clip. Plastic clip that holds a maximum of five pellets and used to place the pellets in the chamber.

Chamber. Location where the pellet is held before firing.

CONFIRMATION OF TEACHING POINT 1

The instructor shall ensure that the cadet can identify the parts of the cadet air rifle by physically pointing to the parts, and having the cadets properly name the part.

Teaching Point 2**Identify the characteristics of the Daisy 853C air rifle.**

Time: 12 min

Method: Interactive Lecture

CHARACTERISTICS

Identify the main characteristics of the cadet air rifle. Focus on these points during the confirmation section of this teaching point.

The characteristics of the Daisy 853C air rifle are:

- **Action.** Single pump pneumatic, straight pull-bolt.
- **Total Length.** 97.8 cm.
- **Total Weight.** 2.5 kg.
- **Calibre.** 0.177 calibre (4.5 mm).
- **Front Sight.** Global type with interchangeable aperture inserts.
- **Rear Sight.** Fully adjustable peep rear sight with micrometer click adjustment.
- **Muzzle Velocity.** 150.8 metres per second.
- **Loading.** Single or auto indexing five-pellet clip.
- **Stock.** Full-length, sporter-styled hardwood with adjustable length.
- **Safety.** Manual cross-bolt trigger block with red indicator.



These characteristics are “Nice to Know” and should be taught only if time permits.

- **Barrel.** Lothar Walther rifled high-grade steel barrel with weight: crowned 12 lands and grooves, right hand twist. Precision bore sized for match pellets. Approximate length 53.1 cm.
- **Maximum Range.** 235.4 metres.
- **Sling.** Adjustable competition web.
- **Trigger Weight.** Minimum 3.5 lb.
- **Chamber.** Open loading and made of steel.
- **Pumping Force.** 20 lbf.



With a muzzle velocity of 150.8 metres per second, the cadet air rifle is not a “firearm” under the current federal firearms legislation, but it is treated as one under the definition used by the Military Police.

CONFIRMATION OF TEACHING POINT 2

QUESTIONS

- Q1. The cadet air rifle has what type of action?
Q2. What is the calibre of the cadet air rifle?
Q3. The cadet air rifle uses what type of safety?

ANTICIPATED ANSWERS

- A1. Single pump pneumatic, straight pull-bolt.
A2. 0.177 calibre (4.5 mm).
A3. Manual cross-bolt trigger block with red indicator.

END OF LESSON CONFIRMATION

This EO may be confirmed with the handout found at Attachment A. Allow cadets a few minutes to complete the handout, then have cadets switch sheets for correcting.



Correctly labelled diagram is located at page M106.01A-2.

CONCLUSION

HOMEWORK/READING/PRACTICE

Cadets are to take home the corrected handout to study the parts of the cadet air rifle.

METHOD OF EVALUATION

Nil.

CLOSING STATEMENT

Knowing the parts and characteristics of the cadet air rifle is important in understanding how the rifle works. This allows the cadet to be able to follow directions given on the range, and properly perform a handling test whenever an air rifle is to be used.

INSTRUCTOR NOTES/REMARKS

Emphasis must be placed on the safety aspect of this lesson.

REFERENCES

A0-027 A-CR-CCP-177/PT-001 D Cdts 3. (2001). *Canadian Cadet Movement: Cadet Marksmanship Programme Reference Manual*. Ottawa, ON: Department of National Defence.

THIS PAGE INTENTIONALLY LEFT BLANK

PARTS AND CHARACTERISTICS OF THE CADET AIR RIFLE

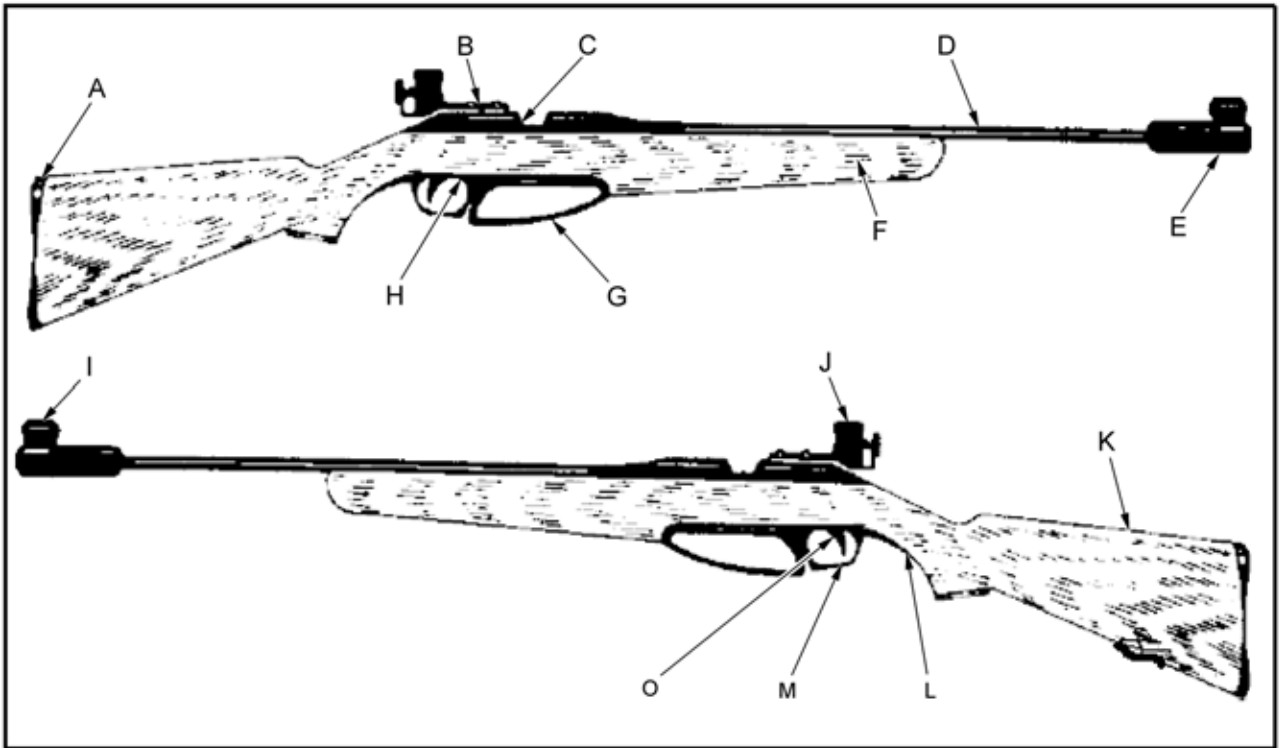

Put the letter next to the matching name of the part of the cadet air rifle.

- | | | | |
|----------------------|-------|-------------------|-------|
| 1. Feed Track | _____ | 8. Safety Catch | _____ |
| 2. Small of the Butt | _____ | 9. Muzzle | _____ |
| 3. Barrel | _____ | 10. Pump Lever | _____ |
| 4. Fore End | _____ | 11. Front Sight | _____ |
| 5. Rear Sight | _____ | 12. Trigger Guard | _____ |
| 6. Trigger | _____ | 13. Butt Plate | _____ |
| 7. Bolt | _____ | 14. Stock | _____ |

ANSWER KEY

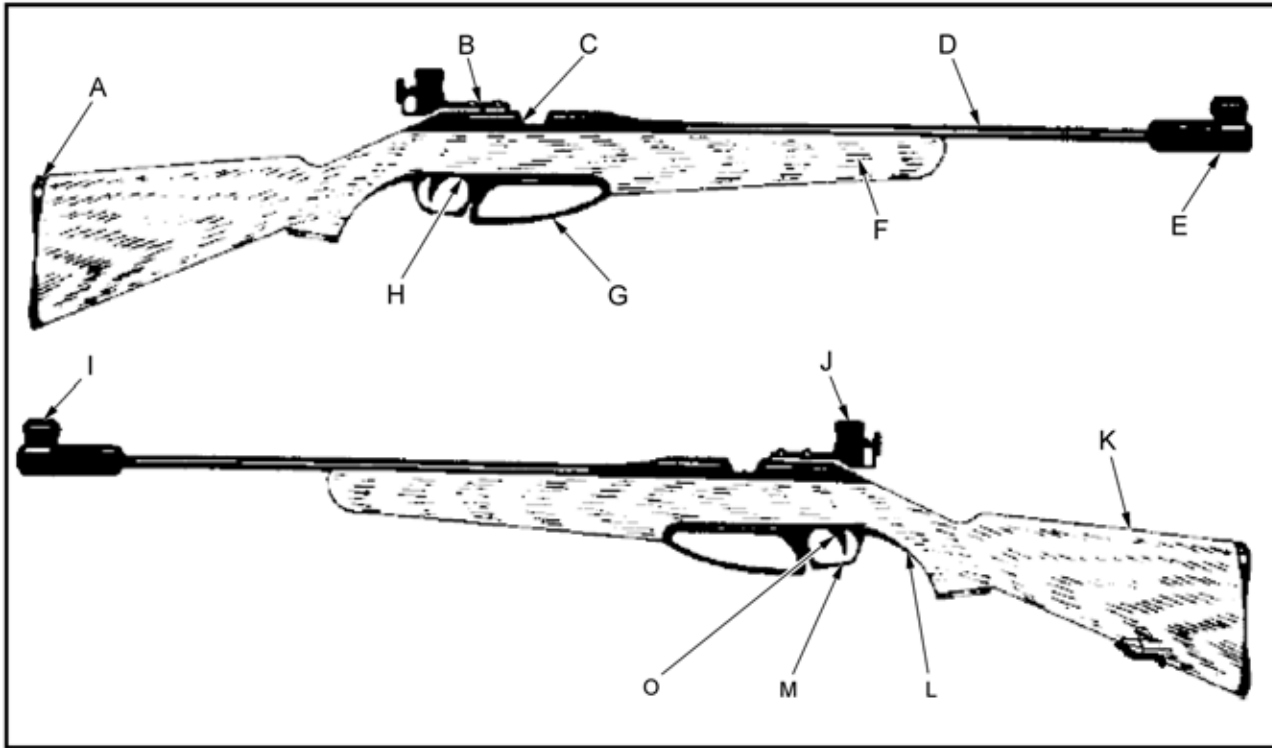

Put the letter next to the matching name of the part of the cadet air rifle.

- | | | | |
|----------------------|------------------------------|-------------------|------------------------------|
| 1. Feed Track | <u> C </u> | 8. Safety Catch | <u> H </u> |
| 2. Small of the Butt | <u> L </u> | 9. Muzzle | <u> E </u> |
| 3. Barrel | <u> D </u> | 10. Pump Lever | <u> G </u> |
| 4. Fore End | <u> F </u> | 11. Front Sight | <u> I </u> |
| 5. Rear Sight | <u> J </u> | 12. Trigger Guard | <u> M </u> |
| 6. Trigger | <u> O </u> | 13. Butt Plate | <u> A </u> |
| 7. Bolt | <u> B </u> | 14. Stock | <u> K </u> |



**COMMON TRAINING
GREEN STAR
INSTRUCTIONAL GUIDE**



SECTION 2

EO M106.02 – CARRY OUT SAFETY PRECAUTIONS ON THE CADET AIR RIFLE

Total Time:

30 min

PREPARATION

PRE-LESSON INSTRUCTIONS

Resources needed for the delivery of this lesson are listed in the lesson specification located in A-CR-CCP-701/PG-001, *Green Star Qualification Standard and Plan*, Chapter 4. Specific uses for said resources are identified throughout the instructional guide within the TP for which they are required.

Prior to instructing this lesson the instructor shall:

- review the lesson content, and become familiar with the material; and
- carry out a safety precaution check on all rifles to be used during this lesson. State to cadets that the rifles have been inspected and are safe to handle.

PRE-LESSON ASSIGNMENT

Nil.

APPROACH

A demonstration and performance was chosen for TPs 1 and 2 as it allows the instructor to explain and demonstrate safety precautions on the cadet air rifle, while providing an opportunity for the cadets to practice under supervision.

An interactive lecture was chosen for TP 3 to orient the cadets to the safety regulations of the Daisy 853C Air rifle and generate interest.

INTRODUCTION

REVIEW

The pertinent review for this lesson from, EO M106.01 (Section 1), will include:

- Having the cadets identify the characteristics of the Daisy 853C, to include:
 - **Action.** Single pump pneumatic, straight pull-bolt.
 - **Calibre.** 0.177 calibre (4.5 mm).
 - **Safety.** Manual cross-bolt trigger block with red indicator.

- **Loading.** Single or auto indexing five-shot clip.
- **Muzzle Velocity.** 150.8 metres per second.
- Having the cadets identify parts of the Daisy 853C by physically pointing to them and naming them, to include:
 - butt plate,
 - small of the butt (pistol grip),
 - sling bracket (hand stop),
 - trigger,
 - trigger guard,
 - safety catch,
 - bolt,
 - pump lever,
 - muzzle,
 - barrel with barrel weight, and
 - feed track.

OBJECTIVES

By the end of this lesson the cadet shall be expected to carry out individual safety precautions on the cadet air rifle.

IMPORTANCE

Safety precautions are essential to ensure everyone's safety on the range. Every time a cadet picks up a rifle or steps on a range, they must have safety in mind and check to ensure the rifle is safe (an individual safety precaution check when receiving, handing over, or returning to a rifle). Even when a rifle is presumably safe, it is to be checked again.

Teaching Point 1**Explain and demonstrate safe rifle status for the cadet air rifle.**

Time: 10 min

Method: Demonstration and Performance

REMOVING A RIFLE FROM THE CASE

The rifle case should be clearly marked on the outside with an arrow, indicating in what direction the rifle inside is pointing. This will ensure that, when the case is opened, the rifle is pointing in a safe direction. The following steps must be followed when removing a rifle from its case:

1. Place the rifle case on a flat surface and ensure the arrow is pointing in a safe direction.
2. Open the case.
3. Cock the action (leave the bolt to the rear).
4. Confirm that the safety catch is ON.
5. Confirm that the pumping lever is partially open.
6. Slide the safety rod in the barrel towards the bolt until it can be seen in the feed track.
7. Remove the rifle from the case.
8. Remove the safety rod when you are on the firing line.

SAFETY CATCH AND SECURITY MEASURES

The safety catch is a mechanism that, once engaged, prevents a rifle from firing by locking its trigger into place. It is located just in front of the trigger, on the trigger guard. To engage the safety catch (ON) it must be pushed towards the right **so no red can be seen**. To fire, the safety catch must be pushed towards the left in the OFF position and a red mark must be seen on it. For maximum security, it is recommended that the safety catch be kept engaged until the rifle is ready for firing.

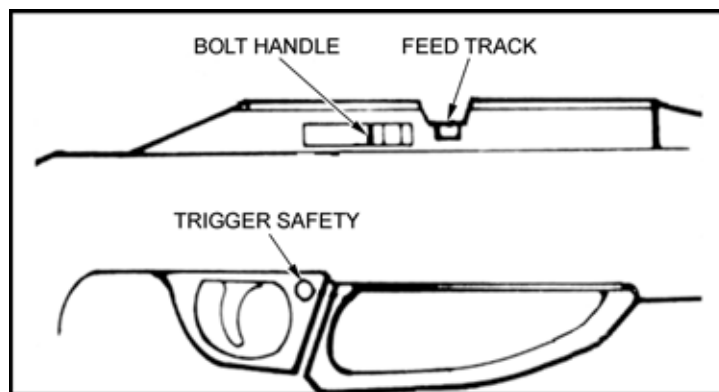

Daisy 853C Operational Manual

Figure 1 Safety Catch

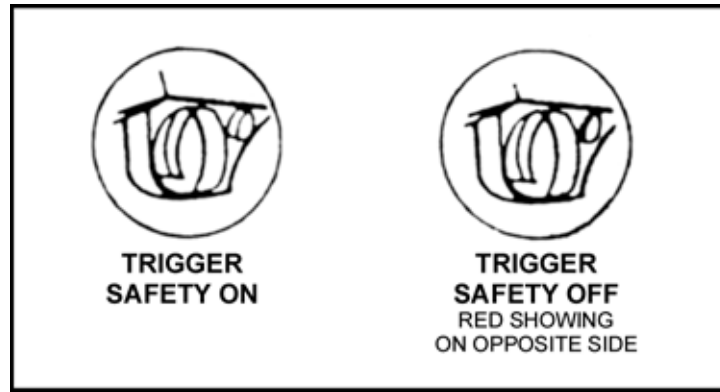

Daisy 853C Operational Manual

Figure 2 Safety Catch Detail View

SAFETY ROD

To ensure that air rifles are not removed from the firing point or stored with a pellet in the chamber or barrel, a safety rod is to be inserted in the barrel from the muzzle end. It consists of two sections of doweling joined together in a “T” shape, and may be made of varying materials. Dimensions are detailed in Figure 3. The tip of the safety rod is to be coloured red so that it is visible in the feed track with the bolt fully to the rear.

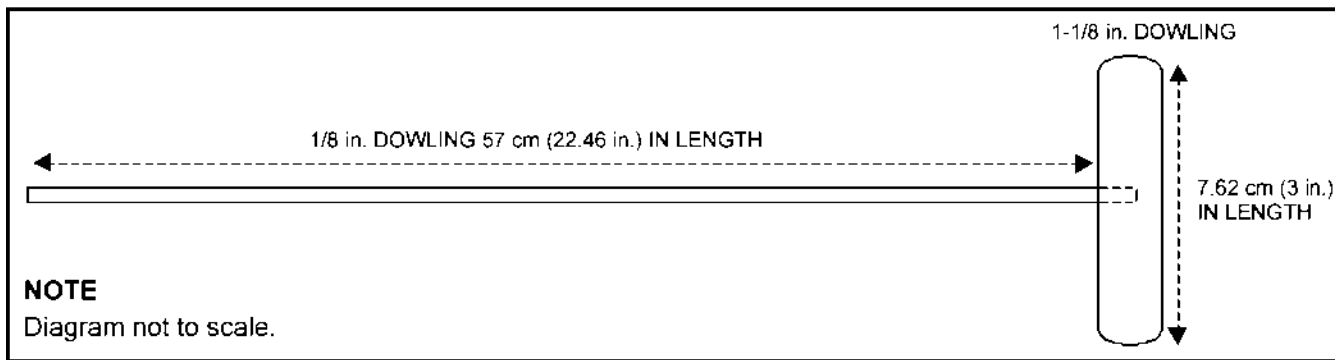

Cadet Marksmanship Program Reference Manual

Figure 3 Safety Rod

SAFE RIFLE STATUS



The instructor shall demonstrate and explain points 1, 2 and 3 of the safe rifle status checks using full demonstrations and explanations prior to each new skill, followed by a chance for the cadets to imitate the skill under supervision.

When not being handled on the range or in a training environment, the air rifle must be in a safe status. The following options denote various states of “safe rifle status”:

1. **In the rifle case:**
 - (a) The safety catch is ON.
 - (b) The bolt is forward.
 - (c) The action is not cocked.

- (d) The safety rod is in the case but not in the barrel.
 - (e) The pump lever is partially open (5 to 8 cm).
2. **On the firing line:**
- (a) The safety catch is ON.
 - (b) The bolt is to the rear.
 - (c) The pump lever is partially open.
3. **Off the firing line:**
- (a) The safety catch is on.
 - (b) The bolt is to the rear.
 - (c) The safety rod is in the barrel (visible in the feed track).
 - (d) The pump lever is partially open.

CONFIRMATION OF TEACHING POINT 1

Have the cadets, under supervision, perform the steps for “Safe Rifle Status” for:

- a. on the firing line; and
- b. off the firing line.

Teaching Point 2

Carry out individual safety precautions.

Time: 10 min

Method: Demonstration and Performance

INDIVIDUAL SAFETY PRECAUTIONS



The instructor shall provide an EXPLANATION and DEMONSTRATION of the complete skill.
The instructor shall also provide an EXPLANATION and DEMONSTRATION of each step required to effectively complete the skill.

Upon receiving a rifle, or when the “Safe Rifle Status” is uncertain, individual safety precautions shall be done to confirm that the rifle is safe. An individual must ensure that:

1. the bolt is open fully to the rear;
2. the safety catch is in the ON position;
3. the pump lever is left partially open; and
4. a safety rod is placed in the barrel.



Cadets will IMITATE the demonstration provided by the instructor for each step within the skill. The instructor(s) will SUPERVISE the cadets during this imitation.

CONFIRMATION OF TEACHING POINT 2

Have cadets carry out individual safety precautions. Cadets will also be required to perform this skill during their air rifle handling test.

Teaching Point 3

Explain and demonstrate safety regulations for the cadet air rifle.

Time: 5 min

Method: Interactive Lecture

SAFETY REGULATIONS

Safety regulations are all common sense and are easy to apply when people understand that they are necessary to help prevent accidents with the air rifle. Regulations include:

1. treating the air rifle as if it is loaded;
2. never pointing the air rifle at anyone;
3. holding the rifle vertically when moving to and from the firing point;
4. leaving fingers off the trigger until ready to fire;
5. wearing safety glasses/goggles; and
6. employing hygiene on the range by washing hands after every practice.



The Canadian Firearms Centre safety training teaches that the vital four “**ACTS**” of firearm safety. The acronym “**ACTS**” stands for:

- **A**ssume every firearm is loaded.
- **C**ontrol the muzzle direction at all times.
- **T**rigger finger must be kept off the trigger and out of the trigger guard.
- **S**ee that the firearm is unloaded – prove it safe.

CONFIRMATION OF TEACHING POINT 3

QUESTIONS

- Q1. Why do we follow safety regulations?
- Q2. What are some common sense safety regulations?
- Q3. What does the acronym “ACTS” stand for?

ANTICIPATED ANSWERS

- A1. To help prevent accidents with the air rifle.

A2. Any from list taught:

- (a) Treating the air rifle as if it is loaded.
- (b) Never point the air rifle at anyone.
- (c) Holding the rifle vertically when moving to and from the firing point.
- (d) Leaving fingers off the trigger until ready to fire.
- (e) Wearing safety glasses/goggles.
- (f) Employing hygiene on the range by washing hands after every practice.

A3. **ACTS** stands for; **A**ssume every firearm is loaded, **C**ontrol the muzzle direction at all times, **T**rigger finger must be kept off the trigger and out of the trigger guard, **S**ee that the firearm is unloaded – prove it safe.

END OF LESSON CONFIRMATION

QUESTIONS

- Q1. What does the arrow on the rifle case indicate?
- Q2. How do we know if the safety catch is ON?
- Q3. What are the vital four “**ACTS**” of firearm safety?

ANTICIPATED ANSWERS

- A1. The direction of the rifle inside the case.
- A2. No red can be seen.
- A3. **ACTS** stands for; **A**ssume every firearm is loaded, **C**ontrol the muzzle direction at all times, **T**rigger finger must be kept off the trigger and out of the trigger guard, **S**ee that the firearm is unloaded – prove it safe.

CONCLUSION

HOMEWORK/READING/PRACTICE

Nil.

METHOD OF EVALUATION

Assessment of this EO will occur during EO M106.05 (Participate in Marksmanship Familiarization Using the Cadet Air Rifle), where cadets are required to successfully complete the Cadet Air Rifle Handling Test prior to firing.

CLOSING STATEMENT

Being able to carry out safety precautions on the cadet air rifle is essential for functioning safely on the range following directions given on the range, and successfully performing a handling test.

INSTRUCTOR NOTES/REMARKS

Emphasis must be placed on the safety aspects of this lesson.

REFERENCES

A0-027 A-CR-CCP-177/PT-001 D Cdts 3. (2001). *Canadian Cadet Movement: Cadet Marksmanship Programme Reference Manual*. Ottawa, ON: Department of National Defence.



**COMMON TRAINING
GREEN STAR
INSTRUCTIONAL GUIDE**



SECTION 3

EO M106.03 – APPLY BASIC MARKSMANSHIP TECHNIQUES

Total Time:

60 min

PREPARATION

PRE-LESSON INSTRUCTIONS

Resources needed for the delivery of this lesson are listed in the lesson specification located in A-CR-CCP-701/PG-001, *Green Star Qualification Standard and Plan*, Chapter 4. Specific uses for said resources are identified throughout the instructional guide within the TP for which they are required.

Prior to instructing this lesson the instructor shall:

- review the lesson content, and become familiar with the material; and
- prepare a mock air rifle range prior to the beginning of the lesson.

PRE-LESSON ASSIGNMENT

Nil.

APPROACH

A demonstration and performance was chosen for this lesson as it allows the instructor to explain and demonstrate basic marksmanship techniques, while providing an opportunity for the cadets to practice under supervision.

INTRODUCTION

REVIEW

The pertinent review for this lesson, from EO M106.02 (Section 2), will include:

QUESTIONS

- Q1. Why are the individual safety precautions performed?
- Q2. What is the purpose of the “safety catch”?

ANTICIPATED ANSWERS

- A1. To confirm a rifle is safe.
- A2. It prevents a rifle from firing by locking its trigger into place.

OBJECTIVES

By the end of this lesson the cadet shall be expected to apply basic marksmanship techniques to include:

- prone position;
- basic holding;
- basic aiming;
- loading;
- firing; and
- unloading.

Cadets will apply the knowledge gained during this lesson when they participate in any range practice.

IMPORTANCE

These techniques must all be applied in harmony. Improving one while not working on another will not produce the best results in the long run. Perfecting these techniques takes time and concentration. Cadets should remember – PRACTICE MAKES PERFECT!

Teaching Point 1**Explain and demonstrate the prone position.**

Time: 4 min

Method: Demonstration and Performance

The first principle of marksmanship is to find a comfortable firing position. A comfortable firing position will enable cadets to fire safely and with much better results. The prone position is the most stable firing position to use.

OBJECTIVES OF A GOOD POSITION

Have cadets down get on the mat and assume the prone position. From here, the instructor is better prepared to observe the cadets imitating the skills being taught.



The instructor shall provide an EXPLANATION and DEMONSTRATION of the complete skill. The instructor shall also provide an EXPLANATION and DEMONSTRATION of each step required to effectively complete the skill.

Obtaining a good prone position is one of the most, if not the most, important principle of marksmanship. A good prone position helps to maintain comfort and stability during the firing session. The prone position is assumed when the marksman lies flat, directly behind the rifle, with a very slight angle between their body and the rifle, and in line with the target. The position should be:

- natural;
- without strain;
- comfortable; and
- stable, in that the:
 - body should form an angle with the line of sight;
 - spine should remain straight;
 - left leg should be parallel with the spine;
 - right foot should turn out and point to the right;
 - left foot should either be straight or point towards the right; and
 - right knee should form an angle with the left leg.

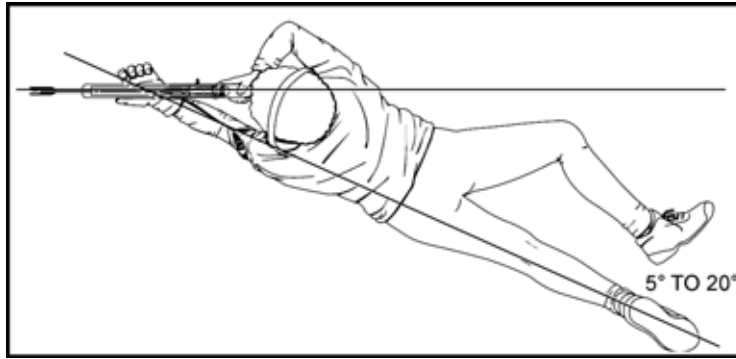

Cadet Marksmanship Program Reference Manual

Figure 1 Prone Position



Cadets will IMITATE the demonstration provided by the instructor for each step within the skill. The instructor(s) will SUPERVISE the cadets during this imitation.

CONFIRMATION OF TEACHING POINT 1



The instructor will divide the group into two, or, by the number of air rifles available.
The instructor shall have one group imitate the actions of the sequence as demonstrated, while the remainder observe. Have them trade places, and repeat.

Teaching Point 2

Explain and demonstrate how to hold the cadet air rifle.

Time: 7 min

Method: Demonstration and Performance

HOLDING THE CADET AIR RIFLE



The instructor shall provide an EXPLANATION and DEMONSTRATION of the complete skill.
The instructor shall also provide an EXPLANATION and DEMONSTRATION of each step required to effectively complete the skill.

The prone position allows holding to be achieved with as little movement and muscular tension as possible, in that the:

- left elbow should be positioned slightly to the left of the rifle;
- left hand must rest firmly against the sling swivel, and the fingers should be relaxed and not grip the fore end;
- right hand should slightly grip the small of the butt with constant pressure;
- right thumb should be placed on the stock directly behind the rear sight or around the small of the butt;
- right elbow should rest naturally where it falls, not too close or too far from the rifle;

- the shoulders should be straight and form right angles with the spine;
- the butt plate is kept firmly in the hollow of the right shoulder. The right elbow will naturally fall in the same spot throughout the relay; and
- the head rests comfortably on the butt and remains straight.



Cadet Marksmanship Program Reference Manual

Figure 2 Prone Position (Front)



Cadet Marksmanship Program Reference Manual

Figure 3 Prone Position (Side)



Cadets will IMITATE the demonstration provided by the instructor for each step within the skill. The instructor(s) will SUPERVISE the cadets during this imitation.

CONFIRMATION OF TEACHING POINT 2



The instructor will divide the group into two, or, by the number of air rifles available. The instructor shall have one group imitate the actions of the sequence as demonstrated, while the remainder observe, and then have them trade places, and repeat.

Teaching Point 3

Explain and demonstrate how to aim the cadet air rifle.

Time: 4 min

Method: Demonstration and Performance

AIMING THE CADET AIR RIFLE

Cadets must constantly strive to maintain proper sight alignment, while obtaining a sight picture. It is the most critical element of the aiming process.

The **aiming process** consists of:

- adopting a comfortable position; and
- ensuring proper body alignment with the target.

Sight Alignment. It is the alignment of the eye, the rear sight, and the front sight. When cadets bring their eye 5 to 15 cm from the rear sight, they will find that the small hole is large enough to look through and see all of the front sight. Proper sight alignment is a matter of centering the front sight tube in the rear sight. The tube will not quite fill the rear sight and cadets will be able to see light around the outside of the tube; we call this a “line of white”.

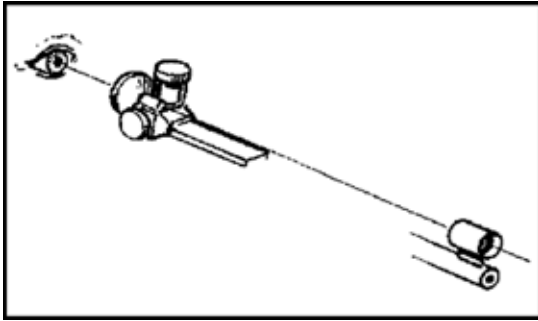

Cadet Marksmanship Program Reference Manual

Figure 4 Sight Alignment

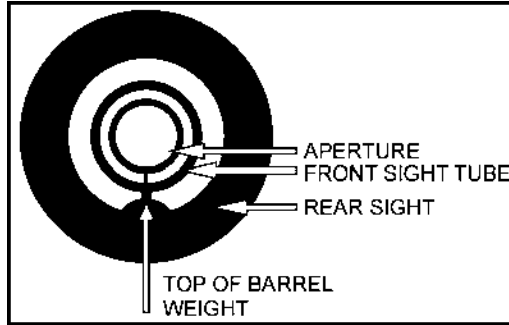

Cadet Marksmanship Program Reference Manual

Figure 5 Line of White

Sight Picture. To obtain a proper sight picture, a bull's-eye is simply added to the innermost ring. The goal during the aiming process is to maintain proper sight alignment while keeping the bull centered in the front sight.

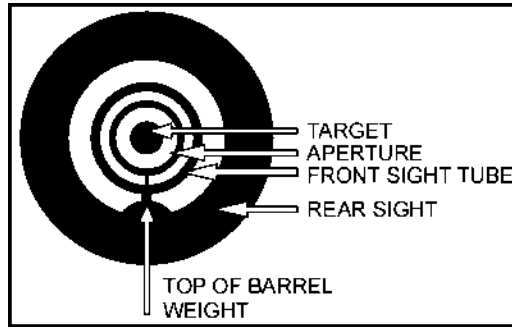

Cadet Marksmanship Program Reference Manual

Figure 6 Sight Picture

CONFIRMATION OF TEACHING POINT 3

QUESTIONS

- Q1. What are the two critical elements of the aiming process?
- Q2. Sight alignment consists of what three things?
- Q3. What is added to the innermost ring to obtain a proper sight picture?

ANTICIPATED ANSWERS

- A1. Adopting a comfortable position, and ensuring proper body alignment with the target.
- A2. The eye, the rear sight, and the front sight.
- A3. A bull's-eye.



The cadets' aiming abilities will be further assessed during future range practices. The instructor(s) will observe cadets during practices, and assess targets to confirm the skill of aiming.

Teaching Point 4

Explain, demonstrate, and have the cadets practice (dry fire) the actions required on the command “Relay, load, commence firing.”

Time: 14 min

Method: Demonstration and Performance

LOADING THE AIR RIFLE

The instructor shall provide an explanation and demonstration of the complete skill.

The instructor shall also provide an explanation and demonstration of each step required to effectively complete the skill.

Then, the cadets, under the supervision of the instructor, will have an opportunity to perform each step.

This will be conducted as a DRY FIRE EXERCISE ONLY.

On the command “Relay load” the following sequence must be followed:

Loading procedure:

1. pick up the rifle with the left hand;
2. ensure the safety catch is in the ON position;
3. pump the air rifle, pausing for three seconds with the pump handle fully extended;
4. bring the pump handle back to closed position;
5. simulate loading a pellet, or load an auto indexing five pellet-clip into the feed track; and
6. close the bolt.



The following methods may be used when pumping the air rifle:

- **Option 1.** Grasp the pistol grip with the right hand. Grasp the pump handle with the left hand. Push downward with the left hand until the pump handle is fully extended. Wait for a few seconds. Using the left hand, bring the pump handle back to the stock of the rifle. The rifle should remain stationary during the pumping process and always point towards the targets.
- **Option 2.** Grasp the pistol grip with the right hand. Grasp the pump handle with the left hand. Place the butt of the rifle under the right arm or shoulder for support. Push downward with the left hand until the pump handle is fully extended. Wait for a few seconds. Using the left hand, bring the pump handle back to the stock of the rifle allowing the underarm and shoulder to help hold the rifle steady when closing the pump handle. Remember that the rifle must always point towards the targets.
- **Option 3. Coach assistance.** Point the rifle in a safe direction and request the assistance from a coach. The coach should move in and pump the rifle using both hands. This should be used as last resorts as any cadet can easily do the above two options.

FIRING THE CADET AIR RIFLE

On the command "Fire", the following sequence must be followed:

1. when the RSO gives the command, place safety catch in the OFF position;
2. aim the air rifle at the target;
3. squeeze the trigger;
4. open the bolt, pump the rifle, re-load, aim and fire;
5. repeat the last step until firing is complete;
6. upon completion, place the safety catch in the ON position, open the bolt and partially open the pump lever; and
7. lay the air rifle down.



Cadet Marksmanship Program Reference Manual

Figure 7 Pumping the air rifle



The rifle should not be pumped more than once per shot. This air rifle is designed to withstand the pressure based on a single pump stroke.

CONFIRMATION OF TEACHING POINT 4

The instructor will divide the group into two, or into the number of air rifles available. The instructor shall have one group imitate the actions of the sequence as demonstrated, while the remainder observe. Have them trade places, and repeat.

Teaching Point 5

Explain, demonstrate, and have the cadets practice the actions required on the command “Relay, unload and prepare for inspection.”

Time: 22 min

Method: Demonstration and Performance



The instructor shall provide an explanation and demonstration of the complete skill.

The instructor shall also provide an explanation and demonstration of each step required to effectively complete the skill.

Then, the cadets, under the supervision of the instructor, will have an opportunity to perform each step.

This will be conducted as a DRY FIRE EXERCISE ONLY.

UNLOADING AND PREPARING FOR INSPECTION

Follow the unloading sequence of the cadet air rifle, to include:

1. pick up the air rifle;
2. remove the five pellet clip (if used);
3. pump the air rifle (hold for three seconds and close);
4. move the bolt forward (do not insert a pellet);
5. place the safety catch in the OFF position;
6. aim the rifle at the target;
7. squeeze the trigger;
8. open the bolt;
9. place the safety catch in the ON position;
10. open the pump lever 5-8 cm;
11. place the rifle on the shoulder, muzzle pointed down range;
12. wait to be cleared by the RSO; and
13. lay the rifle down.

CONFIRMATION OF TEACHING POINT 5

The instructor will divide the group into two, or into the number of air rifles available. The instructor shall have one group imitate the actions of the sequence as demonstrated, while the remainder observe. Have them trade places, and repeat.

END OF LESSON CONFIRMATION

The instructor will divide the group into two, or by the number of air rifles available. The instructor shall have one group imitate the actions of the sequence for all teaching points as demonstrated, while the remainder observe, and then have them trade places, and repeat.

CONCLUSION

HOMEWORK/READING/PRACTICE

Nil.

METHOD OF EVALUATION

Assessment of this EO will occur during EO M106.05 (Participate in Marksmanship Familiarization Using the Cadet Air Rifle), where cadets are required to successfully complete the Cadet Air Rifle Handling Test prior to firing.

CLOSING STATEMENT

The first principle of marksmanship is to find a comfortable firing position. A comfortable firing position will enable cadets to fire safely and with much better results. The prone position is the most stable firing position to use.

INSTRUCTOR NOTES/REMARKS

1. Emphasis must be placed on the safety aspects of this lesson.
2. Ensure thorough confirmation by stages.

REFERENCES

A0-027 A-CR-CCP-177/PT-001 D Cdts 3. (2001). *Canadian Cadet Movement: Cadet Marksmanship Programme Reference Manual*. Ottawa, ON: Department of National Defence.



**COMMON TRAINING
GREEN STAR
INSTRUCTIONAL GUIDE**



SECTION 4

EO M106.04 – FOLLOW RULES AND COMMANDS ON AN AIR RIFLE RANGE

Total Time:

30 min

PREPARATION

PRE-LESSON INSTRUCTIONS

Resources needed for the delivery of this lesson are listed in the lesson specification located in A-CR-CCP-701/PG-001, *Green Star Qualification Standard and Plan*, Chapter 4. Specific uses for said resources are identified throughout the instructional guide within the TP for which they are required.

Prior to instructing this lesson the instructor shall:

- review the lesson content, and become familiar with the material; and
- prepare a mock air rifle range to be used when teaching the lesson.

PRE-LESSON ASSIGNMENT

Nil.

APPROACH

An interactive lecture was chosen for TP 1 to orient the cadets to the rules to be followed on a range and generate interest.

A demonstration and performance was chosen for TP 2 as it allows the instructor to explain and demonstrate responding to range commands, while providing an opportunity for the cadets to practice under supervision.

INTRODUCTION

REVIEW

The pertinent review for this lesson, from EO M106.03 (Section 3), will include:

QUESTIONS

- Q1. What two things do a good prone position help to maintain?
- Q2. Sight alignment consists of what three steps?
- Q3. What is added to the innermost ring to obtain a proper sight picture?

ANTICIPATED ANSWERS

- A1. Comfort and stability.
- A2. The eye, the rear sight, and the front sight.
- A3. A bull's-eye.

OBJECTIVES

By the end of this lesson the cadet shall be expected to handle rifles safely and properly execute range commands.

IMPORTANCE

Firearms safety is the number one priority on and off the range so everyone must do their part to prevent accidents. In marksmanship, the majority of incidents are caused by ignorance of proper rifle operating procedures or by mishandling.

Teaching Point 1**Explain rules cadets must follow on the range.**

Time: 10 min

Method: Interactive Lecture

RULES CADETS MUST FOLLOW ON THE RANGE**The instructor will read Local Range Standing Orders at the beginning of this period.**

Range Standing Orders are locally produced for each range. They detail rules to be followed on that range. General rules observed on all ranges include:

1. Rifles will be proved safe when picked up, handed to or received from another person.
2. Rifles are never pointed at any person.
3. Safety rods shall be inserted into the barrels of rifles when not in use on the range.
4. Horseplay is forbidden on the range.
5. Rifles, whether loaded or not, will always be pointed down range.
6. Eating is not permitted on or near the range or around the pellets.
7. All personnel shall read or be briefed on the contents of the Range Standing Orders.
8. The RSO's directions and orders are to be obeyed at all times.

CONFIRMATION OF TEACHING POINT 1

QUESTIONS

- Q1. When should a rifle be proved safe?
- Q2. When can rifles be pointed at other people?
- Q3. When should the directions and orders of the RSO be followed?

ANTICIPATED ANSWERS

- A1. When picked up, handed to or received from another person.
- A2. Rifles are never pointed at any person.
- A3. The RSO's directions and orders are to be obeyed at all times.

Teaching Point 2**Explain range commands.**

Time: 15 min

Method: Demonstration and Performance



The instructor shall provide an EXPLANATION and DEMONSTRATION of each command and the associated action to be taken.

All loading/firing is to be simulated. No pellets are to be fired.

RANGE COMMANDS CADETS MUST FOLLOW

COMMAND	ACTION
“Cover off your firing point”	Stand up, move behind the firing point and await further commands.
“Place your equipment down and stand back”	Lay the equipment down on the mat and stand back when finished.
“Adopt the prone position”	Adopt the prone position, pick up the rifle, ready the equipment and put on hearing (if applicable) and eye protection.
Type of firing	This command includes information about the range and type of firing. i.e., Relay #__, ten (10) metres, five (5) rounds, Grouping, On Your Own Time...
“Relay, load, commence firing”	<p>Pick up the rifle with the left hand;</p> <p>Ensure the safety catch is in the ON position;</p> <p>Pump the rifle, pausing for three seconds with the pump handle fully extended;</p> <p>Bring the pump handle back to the closed position;</p> <p>Load the pellet;</p> <p>Close the bolt;</p> <p>Place the safety catch in the OFF position; Aim the rifle at the target.</p> <p>Squeeze the trigger;</p> <p>Open the bolt, pump the rifle, re-load, aim, and fire;</p> <p>Repeat the last step until firing is complete;</p> <p>Upon completion, place the safety catch in the ON position, open the bolt, and partially open the pump lever; and</p> <p>Lay down the rifle.</p>
MAY BE GIVEN	

COMMAND	ACTION
<p>“Relay, cease fire”</p> <p>“Relay, resume fire”</p>	<p>Stop firing immediately, put the safety catch in the ON position and lay the rifle down.</p> <p>Put the safety in the OFF position and continue the practice.</p>
<p>“Relay, unload and prepare for inspection”</p>	<p>Pick up the rifle;</p> <p>Remove the five (5) pellet clip if used;</p> <p>Pump the rifle (hold for three seconds and close);</p> <p>Move the bolt forward;</p> <p>Place the safety catch in the OFF position;</p> <p>Aim rifle at target;</p> <p>Pull the trigger;</p> <p>Open the bolt;</p> <p>Place safety catch in the ON position;</p> <p>Open the pump lever 5-8 cm;</p> <p>Place the rifle on the shoulder, muzzle pointed down range;</p> <p>Wait to be cleared by the RSO;</p> <p>Lay the rifle down; and</p> <p>Remove your hearing (if applicable) and eye protection.</p>
<p>“Relay, stand up”</p>	<p>Stand up and leave the equipment on the ground.</p>
<p>“Change targets”</p>	<p>Move forward, walk down the lane to remove old targets and replace them with new ones. Return to the firing point.</p>
<p>“Change relays”</p>	<p>Cadets who have just fired pick up their personal equipment and move off the firing point. The new relay covers off behind the firing point.</p>



Cadets will IMITATE the demonstration provided by the instructor for each step within the process. The instructor(s) will SUPERVISE the cadets during this imitation.



The information in this teaching point is amplified in Annex A, and should be reviewed prior to any cadet participating in a marksmanship practice.

CONFIRMATION OF TEACHING POINT 2

Confirmation of this teaching point shall be accomplished through observation during the above imitation and supervision phases.

END OF LESSON CONFIRMATION

QUESTIONS

- Q1. When is horseplay allowed on the range?
- Q2. The contents of the Range Standing Orders shall be read to whom?
- Q3. What direction must rifles be pointed while on the range?

ANTICIPATED ANSWERS

- A1. Never, it is forbidden.
- A2. Everyone.
- A3. Down range at all times.

CONCLUSION

HOMEWORK/READING/PRACTICE

Study "Range Commands and Action" chart prior to all range practices.

METHOD OF EVALUATION

Assessment of this EO will occur during EO M106.05 (Participate in Marksmanship Familiarization Using the Cadet Air Rifle), where cadets are required to successfully complete the Cadet Air Rifle Handling Test prior to firing.

CLOSING STATEMENT

Firearms safety is the number one priority on and off the range, so everyone must do their part to prevent accidents. In marksmanship, the majority of incidents are caused by either ignorance of proper rifle operating procedures, or by mishandling.

INSTRUCTOR NOTES/REMARKS

Nil.

REFERENCES

A0-027 A-CR-CCP-177/PT-001 D Cdts 3. (2001). *Canadian Cadet Movement: Cadet Marksmanship Programme Reference Manual*. Ottawa, ON: Department of National Defence.

RANGE COMMANDS

COMMAND	ACTION
“Cover off your firing point”	Stand up, move behind the firing point and await further commands.
“Place your equipment down and stand back”	Lay the equipment down on the mat and stand back when finished.
“Adopt the prone position”	Adopt the prone position, pick up the rifle, ready the equipment and put on hearing (if applicable) and eye protection.
Type of firing	This command includes information about the range and type of firing. i.e., Relay #__, ten (10) metres, five (5) rounds, Grouping, On Your Own Time...
“Relay, load, commence firing”	<p>Pick up the rifle with the left hand;</p> <p>Ensure the safety catch is in the ON position;</p> <p>Pump the rifle, pausing for three seconds with the pump handle fully extended;</p> <p>Bring the pump handle back to the closed position;</p> <p>Load the pellet;</p> <p>Close the bolt;</p> <p>Place the safety catch in the OFF position; Aim the rifle at the target.</p> <p>Squeeze the trigger;</p> <p>Open the bolt, pump the rifle, re-load, aim, and fire;</p> <p>Repeat the last step until firing is complete;</p> <p>Upon completion, place the safety catch in the ON position, open the bolt, and partially open the pump lever; and</p> <p>Lay down the rifle.</p>
MAY BE GIVEN	
“Relay, cease fire” “Relay, resume fire”	<p>Stop firing immediately, put the safety catch in the ON position and lay the rifle down.</p> <p>Put the safety in the OFF position and continue the practice.</p>

COMMAND	ACTION
<p>“Relay, unload and prepare for inspection”</p>	<p>Pick up the rifle; Remove the five (5) pellet clip if used; Pump the rifle (hold for three seconds and close); Move the bolt forward; Place the safety catch in the OFF position; Aim rifle at target; Pull the trigger; Open the bolt; Place safety catch in the ON position; Open the pump lever 5-8 cm; Place the rifle on the shoulder, muzzle pointed down range; Wait to be cleared by the RSO; Lay the rifle down; and Remove your hearing (if applicable) and eye protection.</p>
<p>“Relay, stand up”</p>	<p>Stand up and leave the equipment on the ground.</p>
<p>“Change targets”</p>	<p>Move forward, walk down the lane to remove old targets and replace them with new ones. Return to the firing point.</p>
<p>“Change relays”</p>	<p>Cadets who have just fired pick up their personal equipment and move off the firing point. The new relay covers off behind the firing point.</p>



**COMMON TRAINING
GREEN STAR
INSTRUCTIONAL GUIDE**



SECTION 5

EO M106.05 – PARTICIPATE IN MARKSMANSHIP FAMILIARIZATION USING THE CADET AIR RIFLE

Total Time:

90 min

PREPARATION

PRE-LESSON INSTRUCTIONS

Resources needed for the delivery of this lesson are listed in the lesson specification located in A-CR-CCP-701/PG-001, *Green Star Qualification Standard and Plan*, Chapter 4. Specific uses for said resources are identified throughout the instructional guide within the TP for which they are required.

Review the lesson content, unit range standing orders, and become familiar with the material prior to delivering the lesson.

Construct a range IAW A-CR-CCP-177/PT-001, *Canadian Cadet Movement: Cadet Marksmanship Program Reference Manual*.

Photocopy the Cadet Air Rifle Handling Test for each cadet.

PRE-LESSON ASSIGNMENT

Nil.

APPROACH

A practical activity was chosen for this lesson as it is an interactive way to allow the cadet to experience marksmanship familiarization in a safe and controlled environment. This activity contributes to the development of marksmanship skills and knowledge in a fun and challenging setting.

INTRODUCTION

REVIEW

The review for this lesson will be from EO M106.02 (Carry Out Safety Precautions on the Cadet Air Rifle).

QUESTIONS:

- Q1. Why do we follow safety regulations?
- Q2. How would you verify the safety catch is ON?
- Q3. What are the four "ACTS" of firearm safety?

ANTICIPATED ANSWERS:

A1. We follow safety regulations to prevent accidents with the cadet air rifle.

A2. When the safety is ON, no red can be seen.

A3. The mnemonic "ACTS" stands for:

- Assume every firearm is loaded.
- Control the muzzle direction at all times.
- Trigger finger must be kept off the trigger and out of the trigger guard.
- See that the firearm is unloaded (prove it safe).

OBJECTIVES

By the end of this lesson the cadet shall have participated in marksmanship familiarization using the cadet air rifle.

IMPORTANCE

It is important for cadets to participate in a marksmanship familiarization activity because it allows them to experience marksmanship in a fun, dynamic and safe setting.

Teaching Point 1**Supervise the cadets' participation in marksmanship familiarization.**

Time: 10 min

Method: Practical Activity



A range briefing is conducted to pass on vital information and answer any questions the cadets may have prior to participating in a marksmanship activity. The range briefing is required to ensure the safe execution of a marksmanship activity.



The range safety briefing is normally conducted by a Range Safety Officer (RSO), as the safety of the range is their responsibility.

CONDUCT A RANGE BRIEFING

The following elements may be included in a range briefing. They would be adjusted based on the requirements of the activity.

1. Welcome and staff introduction.
2. An overview of the range layout. Description of the out of bounds / danger areas, location of range facilities, location of concurrent activities, as well as routes of access.
3. The general safety rules.
4. An explanation of the activity and course of fire: Type of activity / Training conducted, the distance, the targets being used, the indication (number of rounds and how they will be fired), and the scoring.
5. The equipment being used, eg rifles, ammunition, safety equipment.
6. The safety precautions: individual safety precautions, rifle safety principles, and safe rifle status.
7. The range commands that will be heard during the activity.
8. The cease fire command: When to use it, who can call it, and action upon hearing a cease fire.
9. Immediate actions (IAs) and stoppages: The types of stoppages that may occur and the immediate actions that must be taken.
10. Personal hygiene, eg washing hands after handling ammunition or rifles.
11. First aid and emergencies: Location of first aid point, identification of first aider, action in the event of an emergency, emergency routes of access, emergency response plan.
12. Assignment of relays: Number of relays, assignment of relay, and timing of relay.
13. Concurrent activities: Type, timing, supervisory staff / OPI.
14. Additional items, eg ensuring handling tests have been completed, timing for the activity (when the activity will begin), declaration requirements, breaks, messing / meals / snacks, set up and dismantling of the range.
15. Opportunity for cadets to ask questions.

CONDUCT THE AIR RIFLE HANDLING TEST

As per instructions in the Qualification Standard Plan, Chapter 3, Annex C, conduct the Air Rifle Handling Test.



Each cadet must complete the Air Rifle Handling Test prior to firing pellets or felt cleaning pellets on a range.

ACTIVITY

OBJECTIVE

The objective of this activity is to have the cadets participate in marksmanship familiarization.

RESOURCES

- Cadet air rifle (one per firing lane),
- Air rifle pellets (as per activity chosen),
- Target frames (one per firing lane),
- Targets (as per activity chosen),
- Marksmanship mats (one per firing lane),
- Scoring template,
- .177- / .22-scoring magnifier (scoring magnifier),
- Scoring plug,
- Safety glasses / goggles (one per firing lane and for range staff), and
- Pen / pencil.

ACTIVITY LAYOUT

Nil.

ACTIVITY INSTRUCTIONS

Once the range briefing has been conducted, and cadets have successfully completed the cadet air rifle handling test, supervise the cadets' participation in a marksmanship familiarization activity.

SAFETY

Range activities will be conducted IAW A-CR-CCP-177/PT-001, *Canadian Cadet Movement: Cadet Marksmanship Program Reference Manual*.

CONFIRMATION OF TEACHING POINT 1

The cadets' participation in the activity will serve as the confirmation of this TP.

END OF LESSON CONFIRMATION

The cadets' participation in the marksmanship activity will serve as the confirmation of this lesson.

CONCLUSION

HOMEWORK / READING / PRACTICE

Nil.

METHOD OF EVALUATION

Nil.

CLOSING STATEMENT

Marksmanship is a fun and exciting activity that requires personal discipline and teamwork skills. This activity has also developed into highly competitive levels at the provincial, regional, and national levels.

INSTRUCTOR NOTES / REMARKS

Hand-washing stations must be available for cleanup after the activity is completed.

REFERENCES

A0-027 A-CR-CCP-177/PT-001 Director Cadets 3. (2005). *Canadian cadet movement: Cadet marksmanship program reference manual*. Ottawa, ON: Department of National Defence.

A0-041 CATO 14-41 Director Cadets 4. (2007). *Marksmanship, rifles and ammunition*. Ottawa ON: Department of National Defence.

THIS PAGE INTENTIONALLY LEFT BLANK



**COMMON TRAINING
GREEN STAR
INSTRUCTIONAL GUIDE**



SECTION 6

EO C106.01 – PARTICIPATE IN A RECREATIONAL MARKSMANSHIP ACTIVITY

Total Time:

90 min

PREPARATION

PRE-LESSON INSTRUCTIONS

Resources needed for the delivery of this lesson are listed in the lesson specification located in A-CR-CCP-701/PG-001, *Green Star Qualification Standard and Plan*, Chapter 4. Specific uses for said resources are identified throughout the instructional guide within the TP for which they are required.

Review the lesson content, range standing orders, and become familiar with the material prior to delivering the lesson.

Photocopy the targets located at Attachments B–R as required.

Construct a range IAW A-CR-CCP-177/PT-001, *Canadian Cadet Movement: Cadet Marksmanship Program Reference Manual*.

PRE-LESSON ASSIGNMENT

Nil.

APPROACH

A practical activity was chosen for this lesson as it is an interactive way to allow the cadet to experience recreational marksmanship in a safe and controlled environment. This activity contributes to the development of marksmanship skills and knowledge in a fun and challenging setting.

INTRODUCTION

REVIEW

The review for this lesson consists in the procedures evaluated as part of the Air Rifle Handling Test.

OBJECTIVES

By the end of this lesson the cadet shall have participated in a recreational marksmanship activity.

IMPORTANCE

It is important for cadets to participate in a recreational marksmanship activity because it allows them to experience marksmanship in a fun, dynamic and safe setting.

Teaching Point 1**Supervise the cadet's participation in a recreational marksmanship activity.**

Time: 80 min

Method: Practical Activity



A range briefing is conducted to pass on vital information and answer any questions the cadets may have prior to participating in a marksmanship activity. The range briefing is required to ensure the safe execution of a marksmanship activity.



The range safety briefing is normally conducted by a Range Safety Officer (RSO), as the safety of the range is their responsibility.

CONDUCT A RANGE BRIEFING

The following elements may be included in a range briefing. They would be adjusted based on the requirements of the activity.

1. Welcome and staff introduction.
2. An overview of the range layout. Description of the out of bounds / danger areas, location of range facilities, location of concurrent activities, as well as routes of access.
3. The general safety rules.
4. An explanation of the activity and course of fire: Type of activity / Training conducted, the distance, the targets being used, the indication (number of rounds and how they will be fired), and the scoring.
5. The equipment being used, eg rifles, ammunition, safety equipment.
6. The safety precautions: individual safety precautions, rifle safety principles, and safe rifle status.
7. The range commands that will be heard during the activity.
8. The cease fire command: When to use it, who can call it, and action upon hearing a cease fire.
9. Immediate actions (IAs) and stoppages: The types of stoppages that may occur and the immediate actions that must be taken.
10. Personal hygiene, eg washing hands after handling ammunition or rifles.
11. First aid and emergencies: Location of first aid point, identification of first aider, action in the event of an emergency, emergency routes of access, emergency response plan.
12. Assignment of relays: Number of relays, assignment of relay, and timing of relay.
13. Concurrent activities: Type, timing, supervisory staff / OPI.
14. Additional items, eg ensuring handling tests have been completed, timing for the activity (when the activity will begin), declaration requirements, breaks, messing / meals / snacks, set up and dismantling of the range.
15. Opportunity for cadets to ask questions.

ACTIVITY

OBJECTIVE

The objective of this activity is to have the cadets participate in a recreational marksmanship activity.

RESOURCES

- Cadet air rifle (one per firing lane),
- Cadet air rifle sling (one per firing lane),
- Air rifle pellets (as per activity chosen),
- Target frames (one per firing lane),
- Targets (as per activity chosen),
- Marksmanship mats (one per firing lane),
- Safety glasses / goggles (one per person in the room),
- .177- / .22-scoring magnifier (scoring magnifier),
- Scoring plug,
- Scoring template,
- Stopwatch, and
- Pen / pencil.



Additional resources required for specific marksmanship activities may be found in the Attachments.

ACTIVITY LAYOUT

Nil.

ACTIVITY INSTRUCTIONS

Ensure all cadets have completed the Air Rifle Handling Test prior to the conduct of this activity. Cadets who have not completed the Air Rifle Handling Test must do so prior to firing on the range.

1. Brief cadets on the safety rules or any other guidelines pertaining to the activity.
2. Divide the cadets into relays according to the number of firing lanes.
3. Conduct a recreational marksmanship activity choosing from the following categories:
 - (a) classification,
 - (b) fun activities,

- (c) timed activities, or
- (d) competitive team / individual activities.

SAFETY

Range activities will be conducted IAW A-CR-CCP-177/PT-001, *Canadian Cadet Movement: Cadet Marksmanship Program Reference Manual*.

CONFIRMATION OF TEACHING POINT 1

The cadets' participation in the activity will serve as the confirmation of this TP.

END OF LESSON CONFIRMATION

The cadets' participation in the recreational marksmanship activity will serve as the confirmation of this lesson.

CONCLUSION

HOMEWORK / READING / PRACTICE

Nil.

METHOD OF EVALUATION

Nil.

CLOSING STATEMENT

Marksmanship is a fun and exciting activity that requires personal discipline and teamwork skills. This activity has also developed into highly competitive levels at the zone, regional, and national levels.

INSTRUCTOR NOTES / REMARKS

Hand-washing stations must be available for cleanup after the activity is completed.

REFERENCES

A0-027 A-CR-CCP-177/PT-001 Director Cadets 3. (2005). *Canadian cadet movement: Cadet marksmanship program reference manual*. Ottawa, ON: Department of National Defence.

A0-041 CATO 14-41 Director Cadets 4. (2007). *Marksmanship, rifles and ammunition*. Ottawa ON: Department of National Defence.

RECREATIONAL MARKSMANSHIP ACTIVITIES

CLASSIFICATION

- Classification (Attachment B)

FUN ACTIVITIES

- Pyramid (Attachment C)
- Beach Ball (Attachment D)
- Balloons (Attachment E)
- Rack'em Up (Attachment F)
- Lights Out (Attachment G)
- Save the Day (Attachment H)
- Flower Pot (Attachment I)

TIMED ACTIVITIES

- Chase the Dots (Attachment J)
- Speed Grid (Attachment K)
- Beat the Clock (Attachment L)
- Dartboard (Attachment M)
- Cut the Fuses (Attachment N)
- Shoo-Fly (Attachment O)
- Good Break (Attachment P)

COMPETITIVE TEAM / INDIVIDUAL ACTIVITIES

- Simulated Stage 1 Championship (Attachment Q)
- Simulated Stage 2 Championship (Attachment R)

THIS PAGE INTENTIONALLY LEFT BLANK

CLASSIFICATION

CLASSIFICATION ACTIVITY

Objective: To provide cadets the opportunity to obtain marksmanship classifications.

Scoring: The standard for the classification levels are:

1. Marksman: Two five-round groupings within a circle of 3 cm in diameter.
2. First Class Marksman: Two five-round groupings within a circle of 2.5 cm in diameter.
3. Expert Marksman: Two five-round groupings within a circle of 2 cm in diameter.
4. Distinguished Marksman: Two five-round groupings within a circle of 1.5 cm in diameter.

Equipment Required:

- Air rifle marksmanship equipment,
- Cadet air rifle,
- Air rifle pellets (10 per participant),
- CCT2000GRTD Canadian Cadet Movement Air Rifle Grouping Target (two per cadet),
- Air Rifle Grouping Template from A-CR-CCP-177/PT-001 (p. B1-1),
- Target frame, and
- Stopwatch.

Optional aids to firing are limited to the following:

- Cadet air rifle sling,
- Marksmanship jacket,
- Marksmanship glove, and
- Hat.

Activity Instructions:

1. Brief the cadets on the activity being conducted including any safety rules or other guidelines pertaining to the activity.
2. Distribute two targets to each cadet.
3. Have the cadets write their name and date on the targets and attach them to the target frame.
4. Give each cadet in the relay 10 pellets to fire 5 into the centre of each target.
5. Have the cadets fire, in relays, following the commands given by the RSO.
6. Give the cadets 15 minutes to complete firing.
7. Have the cadets retrieve their targets.
8. Score the targets using the Air Rifle Grouping Template.
9. Record the scores and allow the cadets to keep their targets.

The following are prohibited:

- Cross firing,
- Alterations, other than those permitted in A-CR-CCP-177/PT-001 Part 4, Section 4, Para 5.3,
- A pellet-loading clip,
- Supports used as a rest for the rifle or the forearm,
- A spotting scope,
- Use of sights not provided with the cadet air rifle, and
- Coaching.

PYRAMID

Objective: To fire pellets into each point on the pyramid.

Scoring: Score the targets awarding:

- a. three points for each corner hit on the pyramid,
- b. two points for each hit within one block of a corner,
- c. one point for each hit within two blocks of a corner.

Equipment Required:

- Air rifle marksmanship equipment,
- Cadet air rifle,
- Air rifle pellets (6 per participant),
- Pyramid Target (one per participant),
- Target frame, and
- Stopwatch.

Activity Instructions:

1. Brief the cadets on the activity being conducted including any safety rules or other guidelines pertaining to the activity.
2. Distribute a target to each cadet.
3. Have the cadets write their name and date on the target and attach it to the target frame.
4. Give each cadet in the relay six pellets to fire, two pellets into each corner of the pyramid.
5. Have the cadets fire, in relays, following the commands given by the RSO.
6. Give the cadets three minutes to complete firing.
7. Have the cadets retrieve their targets.
8. Score the targets awarding:
 - (a) three points for each corner hit on the pyramid,
 - (b) two points for each hit within one block of a corner,
 - (c) one point for each hit within two blocks of a corner.
9. Allow the cadets to review and keep their targets.

The following are prohibited:

- Alterations, other than those permitted in A-CR-CCP-177/PT-001 Part 4, Section 4, Para 5.3,
- A pellet-loading clip,
- Supports used as a rest for the rifle or the forearm,
- A spotting scope, and
- Use of sights not provided with the cadet air rifle.

PYRAMID TARGET

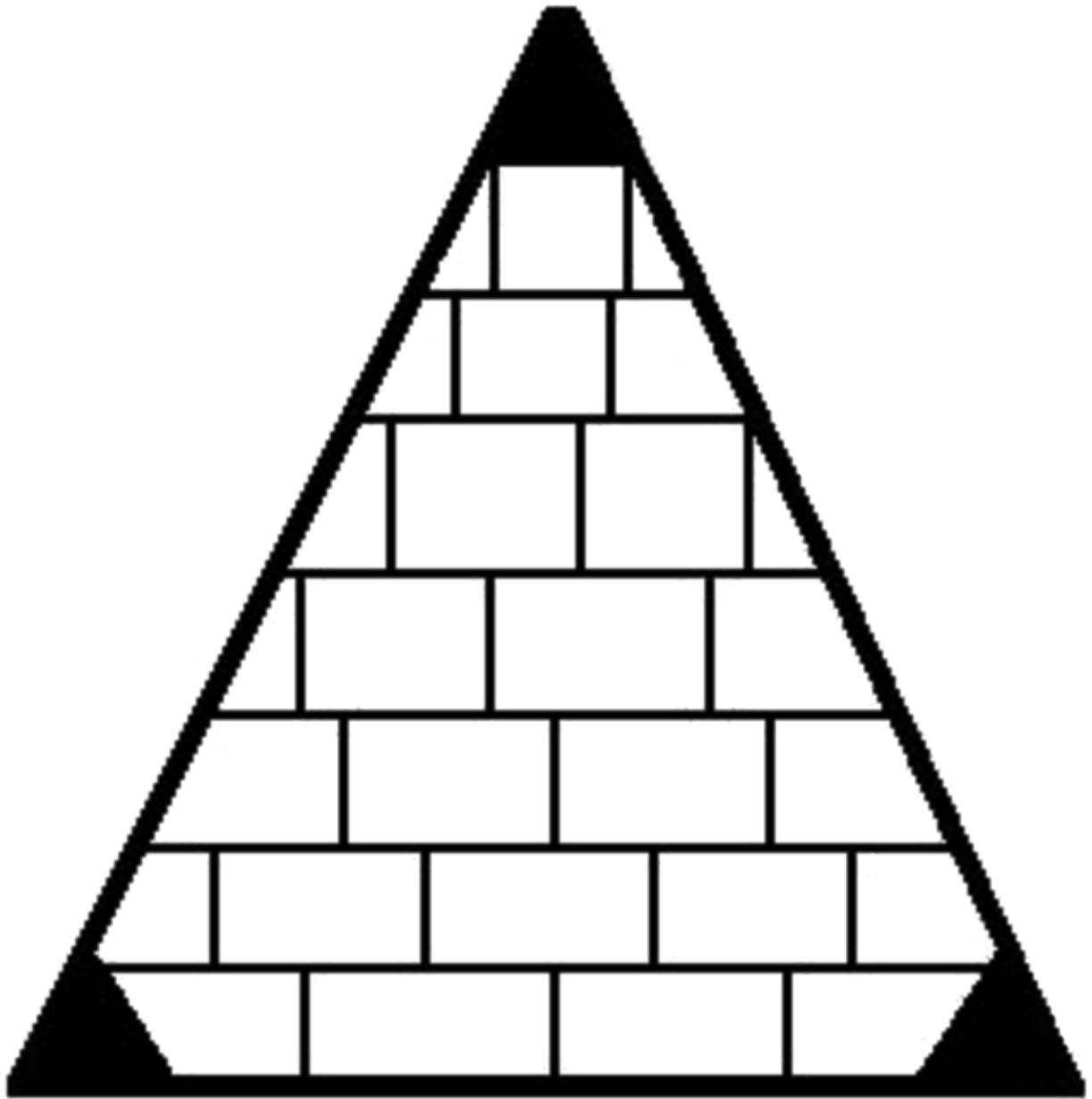

Name:

Date:

Witness:

Score:

THIS PAGE INTENTIONALLY LEFT BLANK

BEACH BALL

Objective: To fire 10 pellets into the black circle on the beach ball.

Scoring: One point is awarded for each successful hit in the black circle.

Equipment Required:

- Air rifle marksmanship equipment,
- Cadet air rifle,
- Air rifle pellets (10 per participant),
- Beach Ball Target (one per participant),
- Target frame, and
- Stopwatch.

Activity Instructions

1. Brief the cadets on the activity being conducted including any safety rules or other guidelines pertaining to the activity.
2. Distribute a target to each cadet.
3. Have the cadets write their name and date on the target and attach it to the target frame.
4. Give the cadets 10 pellets to fire into the black circle of the beach ball.
5. Have the cadets fire, in relays, following the commands given by the RSO.
6. Give the cadets 10 minutes to complete firing.
7. Have the cadets retrieve their targets.
8. Score the targets awarding one point for each pellet hit within the black circle.
9. Allow the cadets to review and keep their targets.

The following are prohibited:

- Cross firing,
- Alterations, other than those permitted in A-CR-CCP-177/PT-001 Part 4, Section 4, Para 5.3,
- A pellet-loading clip,
- Supports used as a rest for the rifle or the forearm,
- A spotting scope, and
- Use of sights not provided with the cadet air rifle.

BEACH BALL TARGET



Name:

Date:

Witness:

Score:

BALLOONS

Objective: To fire pellets into balloons on the target.

Scoring: One point is awarded for each balloon hit by a pellet.

Equipment Required:

- Air rifle marksmanship equipment,
- Cadet air rifle,
- Air rifle pellets (20 per participant),
- Balloon Target (one per participant),
- Target frame, and
- Stopwatch.

Activity Instructions:

1. Brief the cadets on the activity being conducted including any safety rules or other guidelines pertaining to the activity.
2. Distribute a target to each cadet.
3. Have the cadets write their name and date on the target and attach it to the target frame.
4. Give each cadet in the relay 20 pellets to fire, one pellet into each balloon.
5. Have the cadets fire, in relays, following the commands given by the RSO.
6. Give the cadets 15 minutes to complete firing.
7. Have the cadets retrieve their targets.
8. Score the targets awarding one point for each balloon hit.
9. Allow the cadets to review and keep their targets.

The following are prohibited:

- Cross firing,
- Alterations, other than those permitted in A-CR-CCP-177/PT-001 Part 4, Section 4, Para 5.3,
- A pellet-loading clip,
- Supports used as a rest for the rifle or the forearm,
- A spotting scope, and
- Use of sights not provided with the cadet air rifle.

Note: Actual balloons may be used in place of the paper targets.

BALLOON TARGET

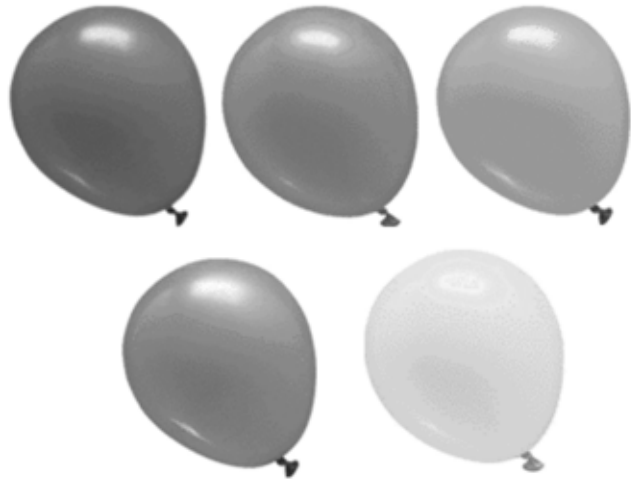
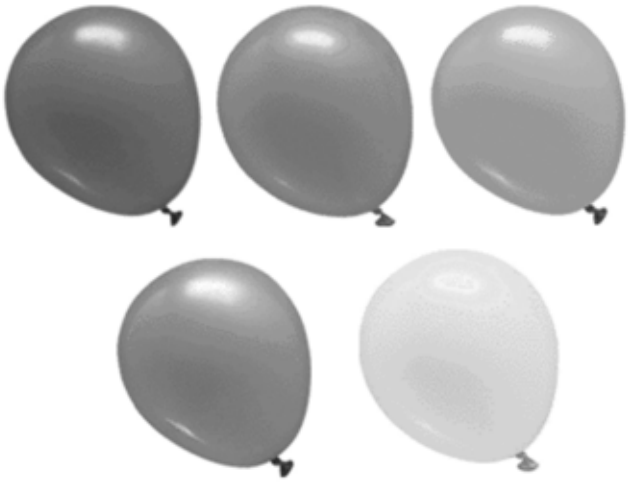
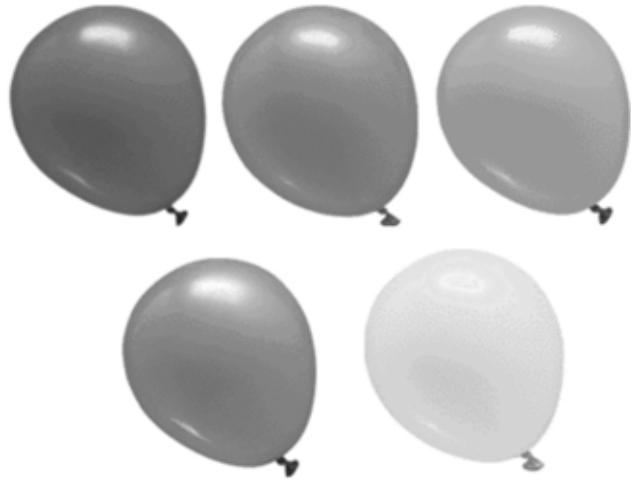
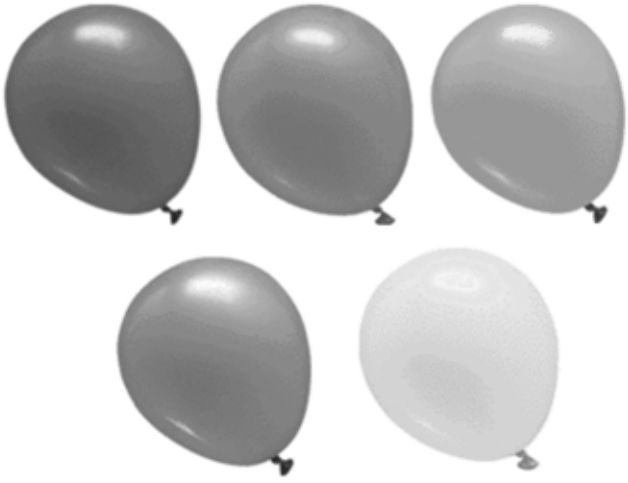

Name:

Date:

Witness:

Score:

RACK'EM UP

Objective: The cadets will be given 15 pellets and 15 minutes to fire a 1 pellet at the centre of each billiard ball.

Scoring: Targets will be scored by totalling the value for each billiard ball where the centre circle has a pellet hole located in it. Value for each ball is found on the billiard ball score sheet.

Equipment Required:

- Air rifle marksmanship equipment,
- Cadet air rifle,
- Air rifle pellets (15 per participant),
- Rack'em up Target (one per participant),
- Rack'em up scoresheet,
- Target frame, and
- Stopwatch.

Activity Instructions:

1. Brief the cadets on the activity being conducted including any safety rules or other guidelines pertaining to the activity.
2. Distribute a target to each cadet.
3. Have the cadets write their name and date on the target and attach it to the target frame.
4. Give each cadet in the relay 15 pellets to fire, one pellet into each billiard ball.
5. Have the cadets fire, in relays, following the commands given by the RSO.
6. Give the cadets 15 minutes to complete firing.
7. Have the cadets retrieve their targets.
8. Score the targets awarding one point for each balloon hit.
9. Allow the cadets to review and keep their targets.

The following are prohibited:

- Cross firing,
- Alterations, other than those permitted in A-CR-CCP-177/PT-001 Part 4, Section 4, Para 5.3,
- A pellet-loading clip,
- Supports used as a rest for the rifle or the forearm,
- A spotting scope, and
- Use of sights not provided with the cadet air rifle.

RACK'EM UP TARGET

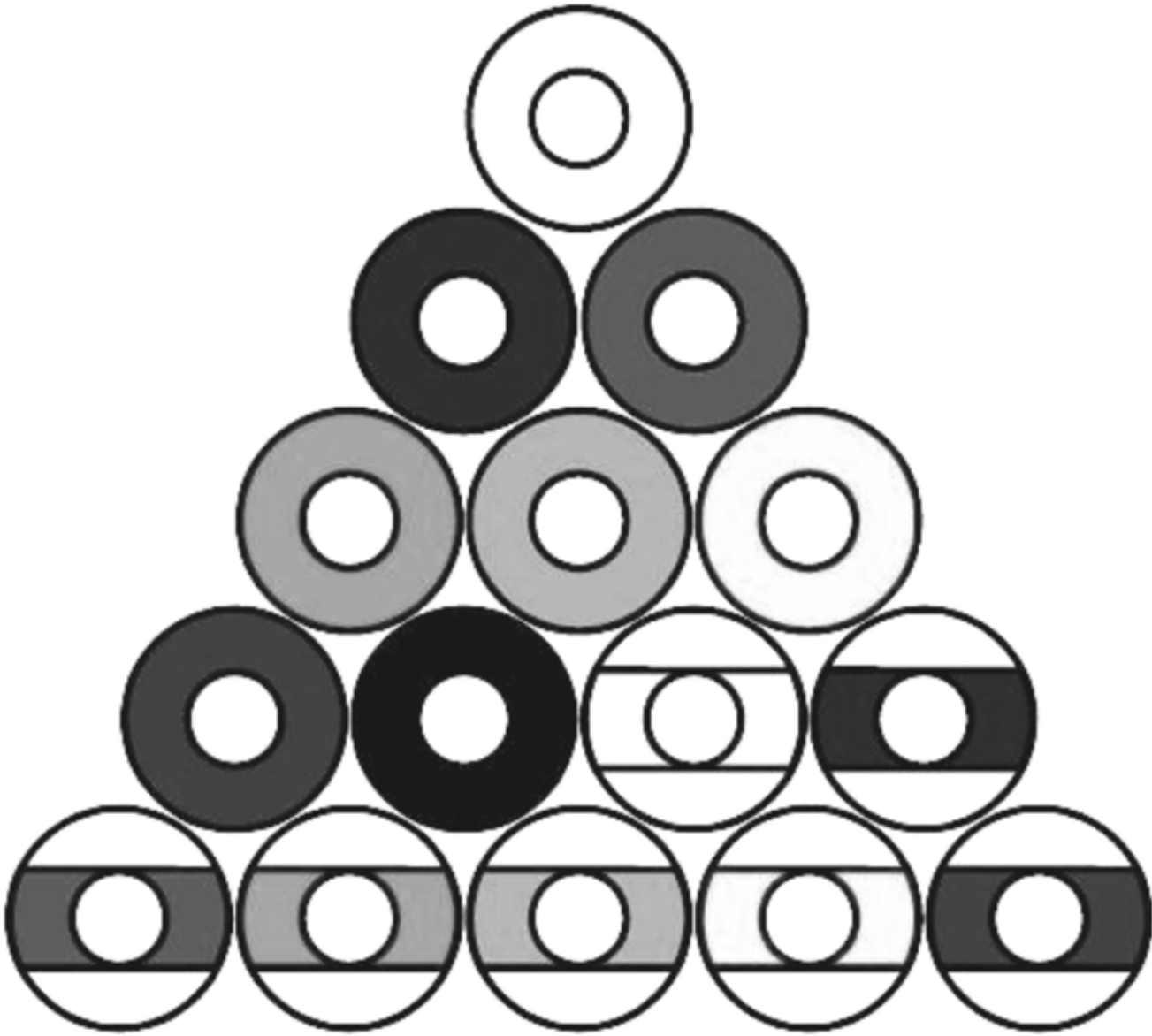

Name:

Date:

Witness:

Score:

RACK'EM UP SCORESHEET

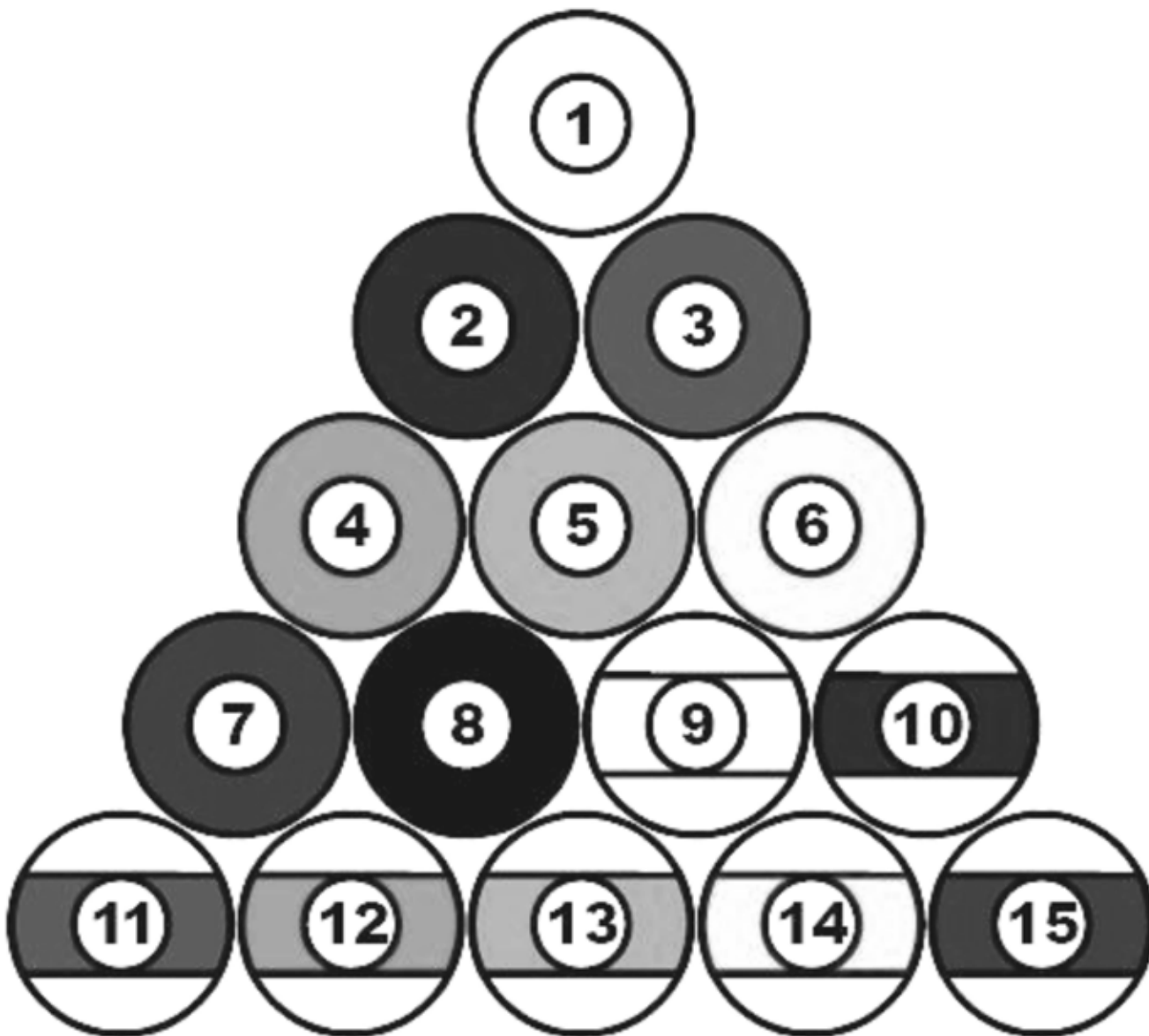

THIS PAGE INTENTIONALLY LEFT BLANK

LIGHTS OUT

Objective: The cadets will be given 10 pellets and 15 minutes to break all 6 light bulbs.

Scoring: One point is awarded for each broken bulb and two points for each broken filament. No points will be awarded for the screw base.

Equipment Required:

- Air rifle marksmanship equipment,
- Cadet air rifle,
- Air rifle pellets (10 per participant),
- Lights Out Target (one per participant),
- Target frame, and
- Stopwatch.

Activity Instructions:

1. Brief the cadets on the activity being conducted including any safety rules or other guidelines pertaining to the activity.
2. Distribute a target to each cadet.
3. Have the cadets write their name and date on the target and attach it to the target frame.
4. Give each cadet in the relay 10 pellets to fire.
5. Have the cadets fire, in relays, following the commands given by the RSO.
6. Give the cadets 15 minutes to complete firing.
7. Have the cadets retrieve their targets.
8. Score the targets (see above).
9. Allow the cadets to review and keep their targets.

The following are prohibited:

- Cross firing,
- Alterations, other than those permitted in A-CR-CCP-177/PT-001 Part 4, Section 4, Para 5.3,
- A pellet-loading clip,
- Supports used as a rest for the rifle or the forearm,
- A spotting scope, and
- Use of sights not provided with the cadet air rifle.

LIGHTS OUT TARGET



Name:

Date:

Witness:

Score:

SAVE THE DAY

Objective: The cadets will be given 5 pellets and 10 minutes to fire at (cut) the fuse of the dynamite.

Scoring: To defuse the dynamite, the cadet must hit the fuse above the split without hitting the dynamite. If the fuse is hit below the split, all three pieces must be hit to defuse the dynamite. A hit on the dynamite will cause it to explode.

Equipment Required:

- Air rifle marksmanship equipment,
- Cadet air rifle,
- Air rifle pellets (five per cadet),
- Save the Day Targets (one per cadet),
- Target frame, and
- Stopwatch.

Activity Instructions:

1. Brief the cadets on the activity being conducted including any safety rules or other guidelines pertaining to the activity.
2. Distribute a target to each cadet.
3. Have the cadets write their name and date on the target and attach it to the target frame.
4. Give each cadet in the relay five pellets to fire at the fuse.
5. Have the cadets fire, in relays, following the commands given by the RSO.
6. Give the cadets 10 minutes to complete firing.
7. Have the cadets retrieve their targets.
8. Score the targets (see above).
9. Allow the cadets to review and keep their targets.

The following are prohibited:

- Cross firing,
- Alterations, other than those permitted in A-CR-CCP-177/PT-001 Part 4, Section 4, Para 5.3,
- A pellet-loading clip,
- Supports used as a rest for the rifle or the forearm,
- A spotting scope, and
- Use of sights not provided with the cadet air rifle.

SAVE THE DAY TARGET

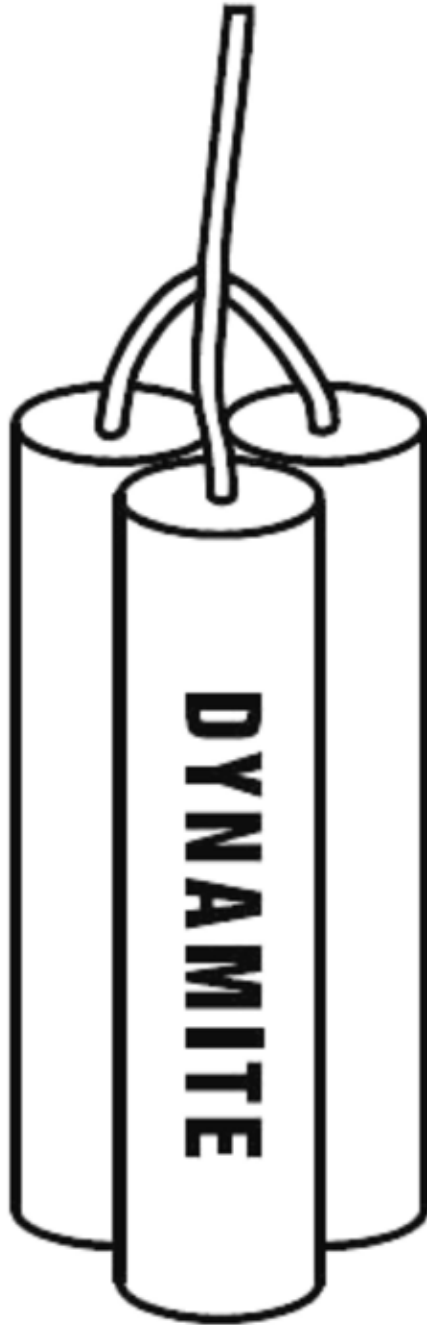

Name:

Date:

Witness:

Score:

FLOWER POT

Objective: The cadets will be given 10 pellets and 15 minutes to hit any part of the flower.

Scoring: One point is awarded for each petal, leaf or stem, and two points for each hit in the centre. One point will be deducted for each hit on the flower pot.

Equipment Required:

- Air rifle marksmanship equipment,
- Cadet air rifle,
- Air rifle pellets (10 pellets per participant),
- Flower Pot Target (one per participant),
- Target frame, and
- Stopwatch.

Activity Instructions:

1. Brief the cadets on the activity being conducted including any safety rules or other guidelines pertaining to the activity.
2. Distribute a target to each cadet.
3. Have the cadets write their name and date on the target and attach it to the target frame.
4. Give each cadet in the relay 10 pellets to fire.
5. Have the cadets fire, in relays, following the commands given by the RSO.
6. Give the cadets 15 minutes to complete firing.
7. Have the cadets retrieve their targets.
8. Score the targets (see above).
9. Allow the cadets to review and keep their targets.

The following are prohibited:

- Cross firing,
- Alterations, other than those permitted in A-CR-CCP-177/PT-001 Part 4, Section 4, Para 5.3,
- A pellet-loading clip,
- Supports used as a rest for the rifle or the forearm,
- A spotting scope, and
- Use of sights not provided with the cadet air rifle.

FLOWER POT TARGET

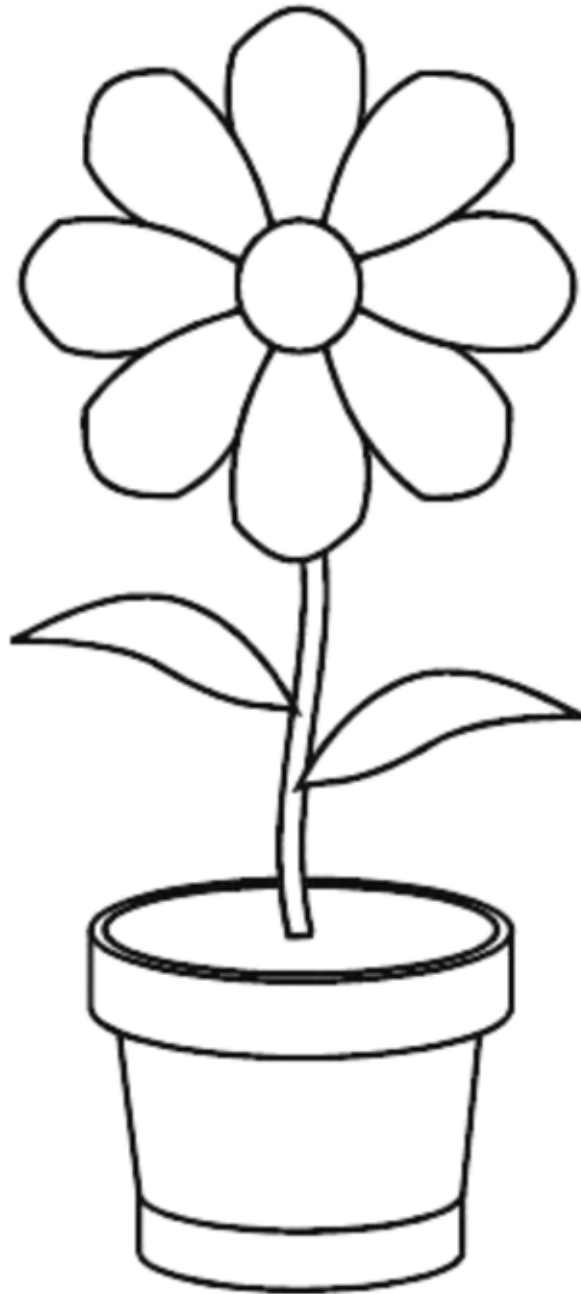

Name:

Date:

Witness:

Score:

CHASE THE DOTS

Objective: To fire pellets into the dots on the target, within a time limit.

Scoring: One point is awarded for each black dot that is hit by a pellet within the time allotted.

Equipment Required:

- Air rifle marksmanship equipment,
- Cadet air rifle,
- Air rifle pellets (10 pellets per participant),
- Chase the Dots Target (one per participant),
- Target frame, and
- Stopwatch.

Activity Instructions:

1. Brief the cadets on the activity being conducted including any safety rules or other guidelines pertaining to the activity.
2. Distribute a target to each cadet.
3. Have the cadets write their name and date on the target and attach it to the target frame.
4. Give the cadets in the relay eight pellets to fire, one pellet into each black dot, in a clockwise direction.
5. Have the cadets fire, in relays, following the commands given by the RSO.
6. Give the cadets four minutes to complete firing.
7. Return any unused pellets to the pellet controller.
8. Have the cadets retrieve their targets.
9. Score the targets awarding one point for each black dot hit.
10. Allow the cadets to review and keep their targets.

The following are prohibited:

- Alterations, other than those permitted in A-CR-CCP-177/PT-001 Part 4, Section 4, Para 5.3,
- A pellet-loading clip,
- Supports used as a rest for the rifle or the forearm,
- A spotting scope,
- Use of sights not provided with the cadet air rifle, and
- Coaching.

Note: To make this activity more difficult, shorten the time allowance.

CHASE THE DOTS TARGET

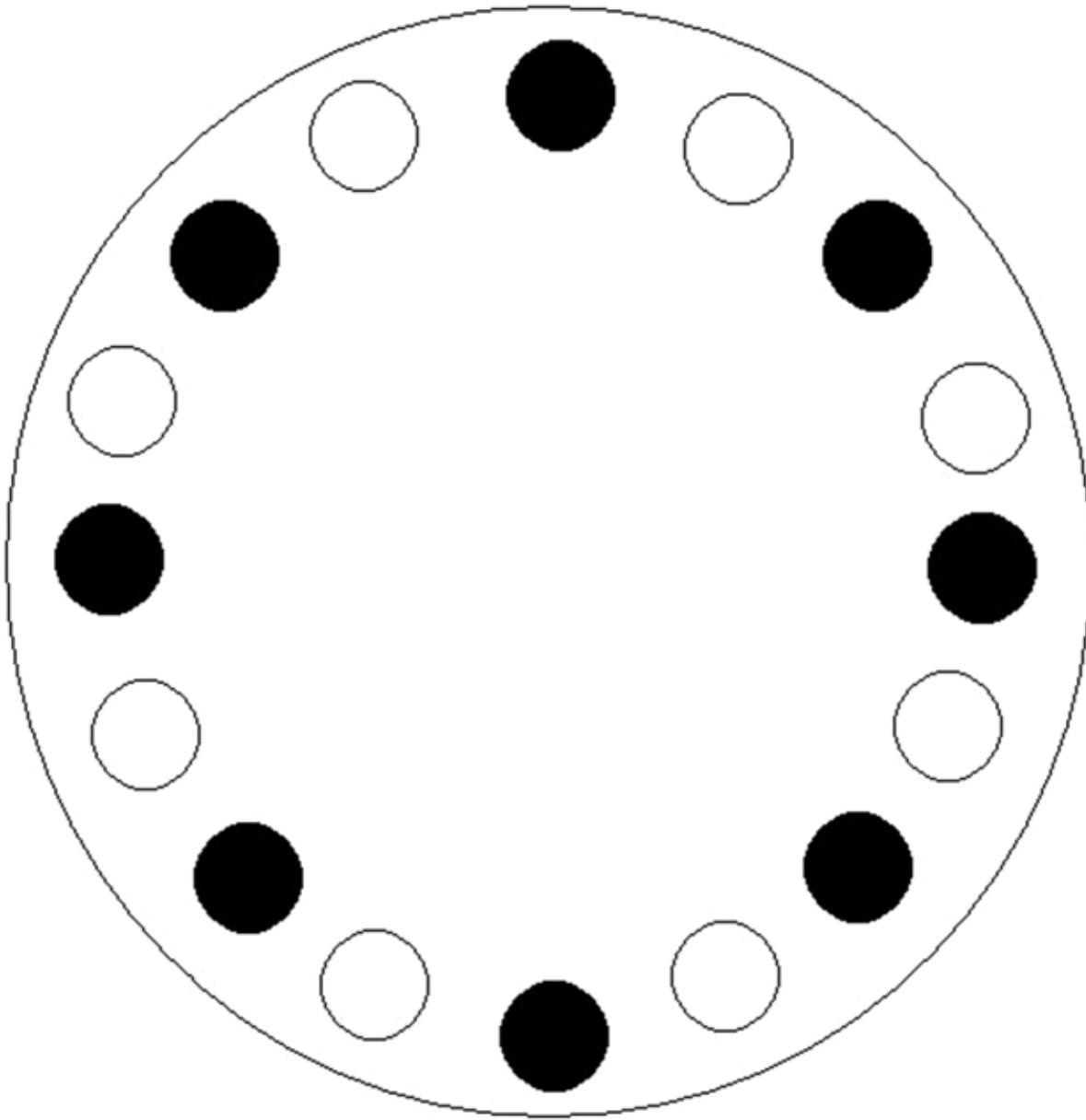

Name: _____

Date: _____

Witness: _____

Score: _____

SPEED GRID

Objective: To fire pellets into the circles on the target, within a time limit.

Scoring: One point is awarded for each circle that is hit by a pellet within the time allotted.

Equipment Required:

- Air rifle marksmanship equipment,
- Cadet air rifle,
- Cadet air rifle five-pellet clip (three per firing lane),
- Air rifle pellets (10 pellets per participant),
- Speed Grid Target (one per participant),
- Target frame, and
- Stopwatch.

Activity Instructions:

1. Brief the cadets on the activity being conducted including any safety rules or other guidelines pertaining to the activity.
2. Distribute a target to each cadet.
3. Have the cadets write their name and date on the target and attach it to the target frame.
4. Give the cadets 15 pellets, pre-loaded into three five-pellet clips.
5. Have the cadets fire one pellet into each circle on the target.
6. Have the cadets fire, in relays, following the commands given by the RSO.
7. Give the cadets eight minutes to complete firing.
8. Return any unused pellets to the pellet controller.
9. Have the cadets retrieve their targets.
10. Score the targets awarding one point for each circle hit.
11. Allow the cadets to review and keep their targets.

The following are prohibited:

- Alterations, other than those permitted in A-CR-CCP-177/PT-001 Part 4, Section 4, Para 5.3,
- Supports used as a rest for the rifle or the forearm,
- A spotting scope,
- Use of sights not provided with the cadet air rifle, and
- Coaching.

Note: To make this activity more difficult, shorten the time allowance.

SPEED GRID TARGET

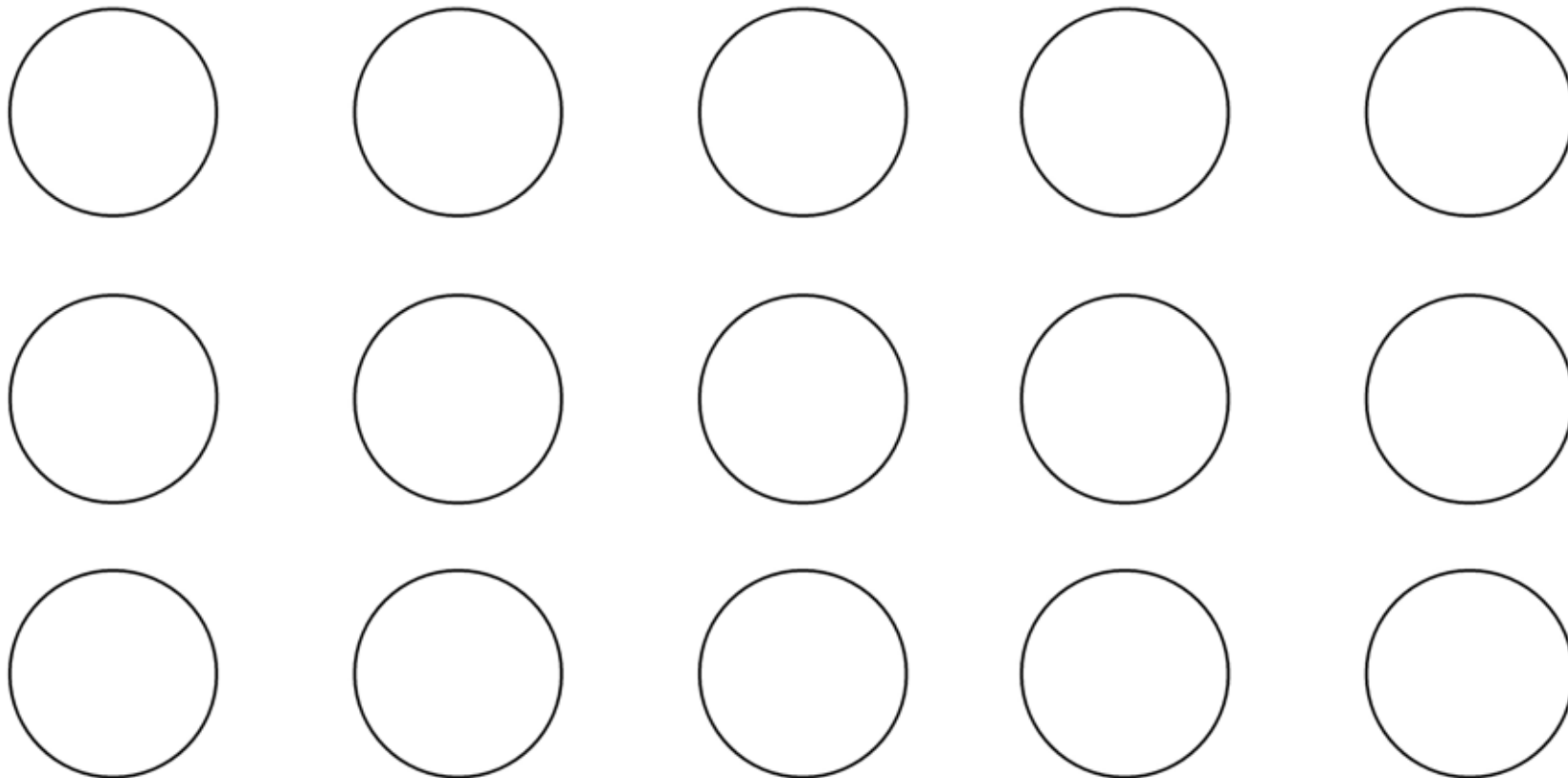

Name: _____

Date: _____

Witness: _____

Score: _____

BEAT THE CLOCK

Objective: To fire pellets into the designated hours (numbers) within a time limit.

Scoring: One point is awarded for each correct hour (number) hit by a pellet within the time allotted.

Equipment Required:

- Air rifle marksmanship equipment,
- Cadet air rifle,
- Cadet air rifle five-pellet clip (three per firing lane),
- Air rifle pellets (10 pellets per participant),
- Beat the Clock Target (one per participant),
- Target frame, and
- Stopwatch.

Activity Instructions:

1. Brief the cadets on the activity being conducted including any safety rules or other guidelines pertaining to the activity.
2. Distribute a target to each cadet.
3. Have the cadets write their name and date on the target and attach it to the target frame.
4. Give the cadets six pellets to fire, one pellet at each hour (number) as it is called.
5. Have the cadets fire, in relays, following the commands given by the RSO.
6. Have the RSO, using the clock, call out one number every 10 second for a total of six numbers.
7. Return any unused pellets to the pellet controller.
8. Have the cadets retrieve their targets.
9. Score the targets awarding one point for each correct number hit on the target.
10. Allow the cadets to review and keep their targets.

The following are prohibited:

- Alterations, other than those permitted in A-CR-CCP-177/PT-001 Part 4, Section 4, Para 5.3,
- Supports used as a rest for the rifle or the forearm,
- A spotting scope,
- Use of sights not provided with the cadet air rifle, and
- Coaching.

Note: To make this activity more difficult, shorten the time allowance.

BEAT THE CLOCK TARGET

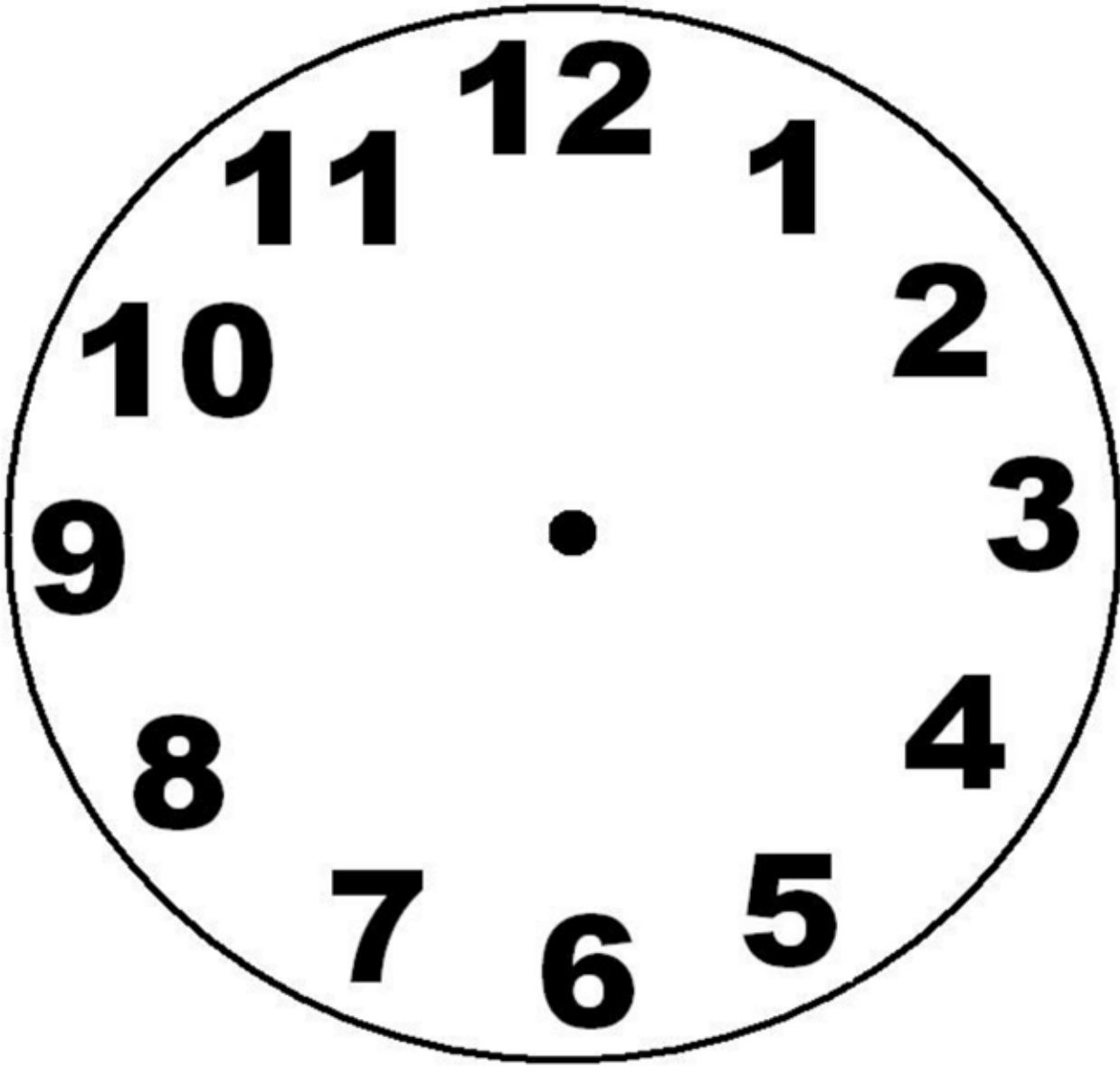

Name: _____

Date: _____

Witness: _____

Score: _____

DARTBOARD

Objective: The cadets will be given 10 pellets and 30 seconds to fire at the highest scores on the dartboard.

Scoring: Targets will be scored by totalling the value for each pellet located in each slice of the board. The bull's-eye has a value of 25 and the area around the outside with the numbers has no point value.

Equipment Required:

- Air rifle marksmanship equipment,
- Cadet air rifle,
- Air rifle pellets (10 per participant),
- Dartboard Target (one per participant),
- Target frame, and
- Stopwatch.

Activity Instructions:

1. Brief the cadets on the activity being conducted including any safety rules or other guidelines pertaining to the activity.
2. Distribute a target to each cadet.
3. Have the cadets write their name and date on the target and attach it to the target frame.
4. Give the cadets 10 pellets to fire.
5. Have the cadets fire a 30 second timed relay, in relays, following the commands given by the RSO.
6. Return unused pellets to the pellet controller.
7. Have the cadets retrieve their targets.
8. Score the targets (see above).
9. Allow the cadets to review and keep their targets.

The following are prohibited:

- Alterations, other than those permitted in A-CR-CCP-177/PT-001 Part 4, Section 4, Para 5.3,
- Supports used as a rest for the rifle or the forearm,
- A spotting scope,
- Use of sights not provided with the cadet air rifle, and
- Coaching.

Note: To make this activity more difficult, shorten the time allowance.

DARTBOARD TARGET

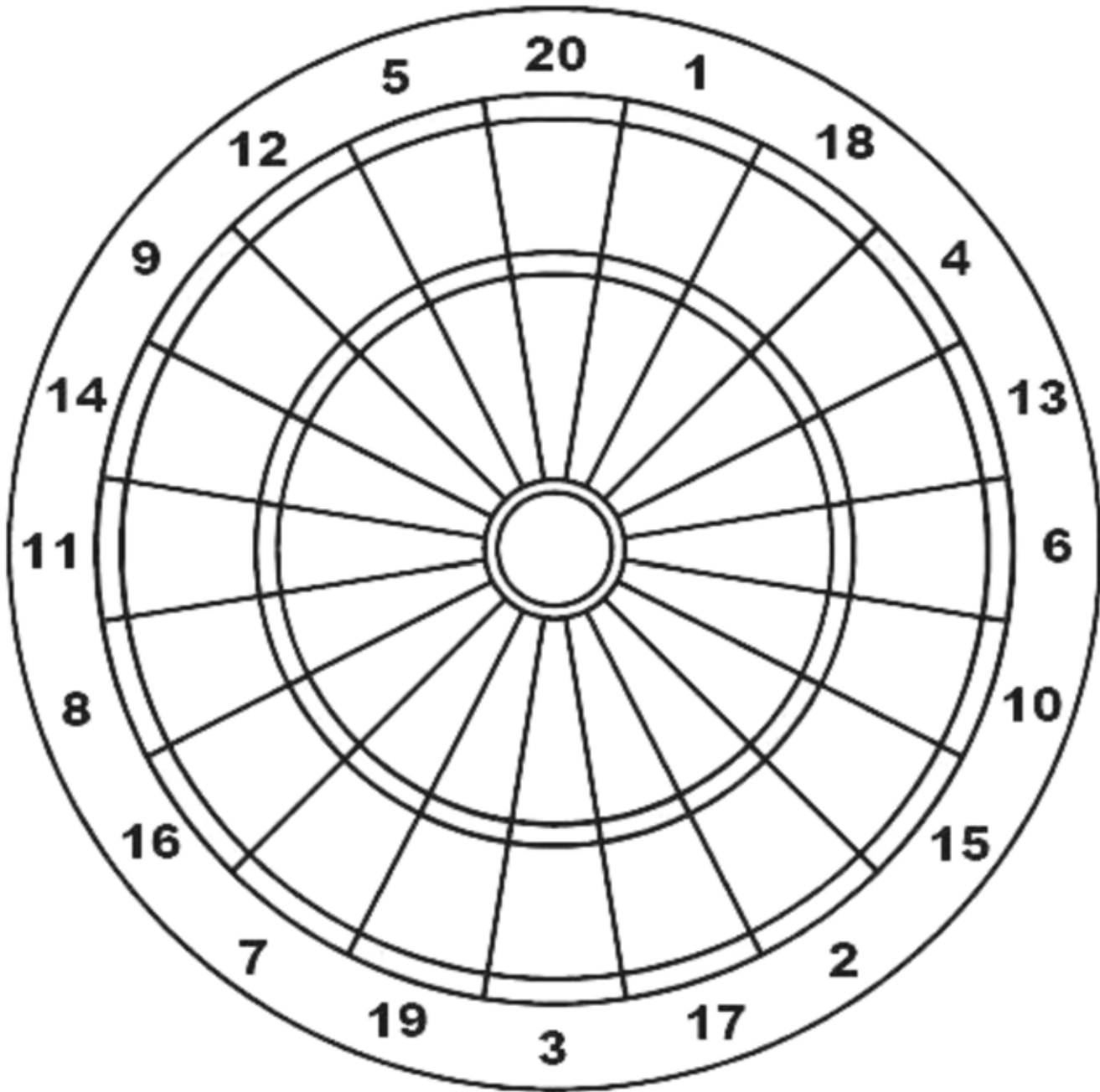

Name: _____

Date: _____

Witness: _____

Score: _____

CUT THE FUSES

Objective: The cadets will be given 10 pellets and 30 seconds to fire at the fuses of all 4 pieces of dynamite.

Scoring: The cadets must hit any portion of the fuse without hitting the dynamite; all four pieces must be hit to defuse the dynamite.

Equipment Required:

- Air rifle marksmanship equipment,
- Cadet air rifle,
- Air rifle pellets (10 per participant),
- Cut the Fuses Target (one per participant),
- Target frame, and
- Stopwatch.

Activity Instructions:

1. Brief the cadets on the activity being conducted including any safety rules or other guidelines pertaining to the activity.
2. Distribute a target to each cadet.
3. Have the cadets write their name and date on the target and attach it to the target frame.
4. Give the cadets 10 pellets to fire.
5. Have the cadets fire a 30 second timed relay, in relays, following the commands given by the RSO.
6. Return unused pellets to the pellet controller.
7. Have the cadets retrieve their targets.
8. Score the targets (see above).
9. Allow the cadets to review and keep their targets.

The following are prohibited:

- Alterations, other than those permitted in A-CR-CCP-177/PT-001 Part 4, Section 4, Para 5.3,
- Supports used as a rest for the rifle or the forearm,
- A spotting scope,
- Use of sights not provided with the cadet air rifle, and
- Coaching.

Note: To make this activity more difficult, shorten the time allowance.

CUT THE FUSES TARGET

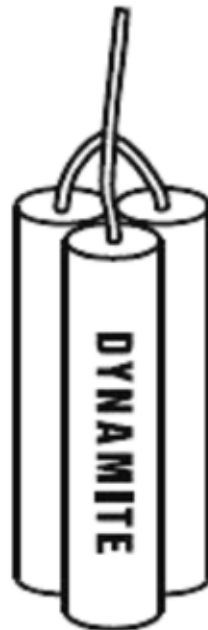
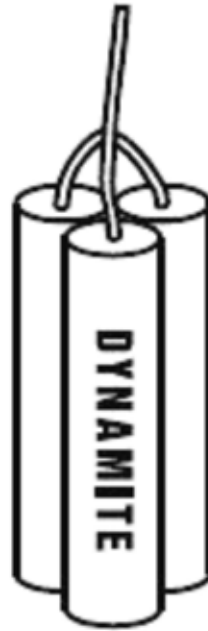

Name:

Date:

Witness:

Score:

SHOO-FLY

Objective: To provide cadets the opportunity to lead a timed air rifle marksmanship activity.

Scoring: Targets will be scored by totalling the number of flies hit. Each fly can only be hit once.

Equipment Required:

- Air rifle marksmanship equipment,
- Cadet air rifle,
- Air rifle pellets (20 per participant),
- Shoo-fly Target (one per participant),
- Target frame, and
- Stopwatch.

Activity Instructions:

1. Brief the cadets on the activity being conducted including any safety rules or other guidelines pertaining to the activity.
2. Distribute a target to each cadet.
3. Have the cadets write their name and date on the target and attach it to the target frame.
4. Give the cadets 20 pellets to fire.
5. Have the cadets fire a five minute timed relay, in relays, following the commands given by the RSO.
6. Return unused pellets to the pellet controller.
7. Have the cadets retrieve their targets.
8. Score the targets (see above).
9. Allow the cadets to review and keep their targets.

The following are prohibited:

- Alterations, other than those permitted in A-CR-CCP-177/PT-001 Part 4, Section 4, Para 5.3,
- Supports used as a rest for the rifle or the forearm,
- A spotting scope,
- Use of sights not provided with the cadet air rifle, and
- Coaching.

Note: To make this activity more difficult, shorten the time allowance.

SHOO-FLY TARGET

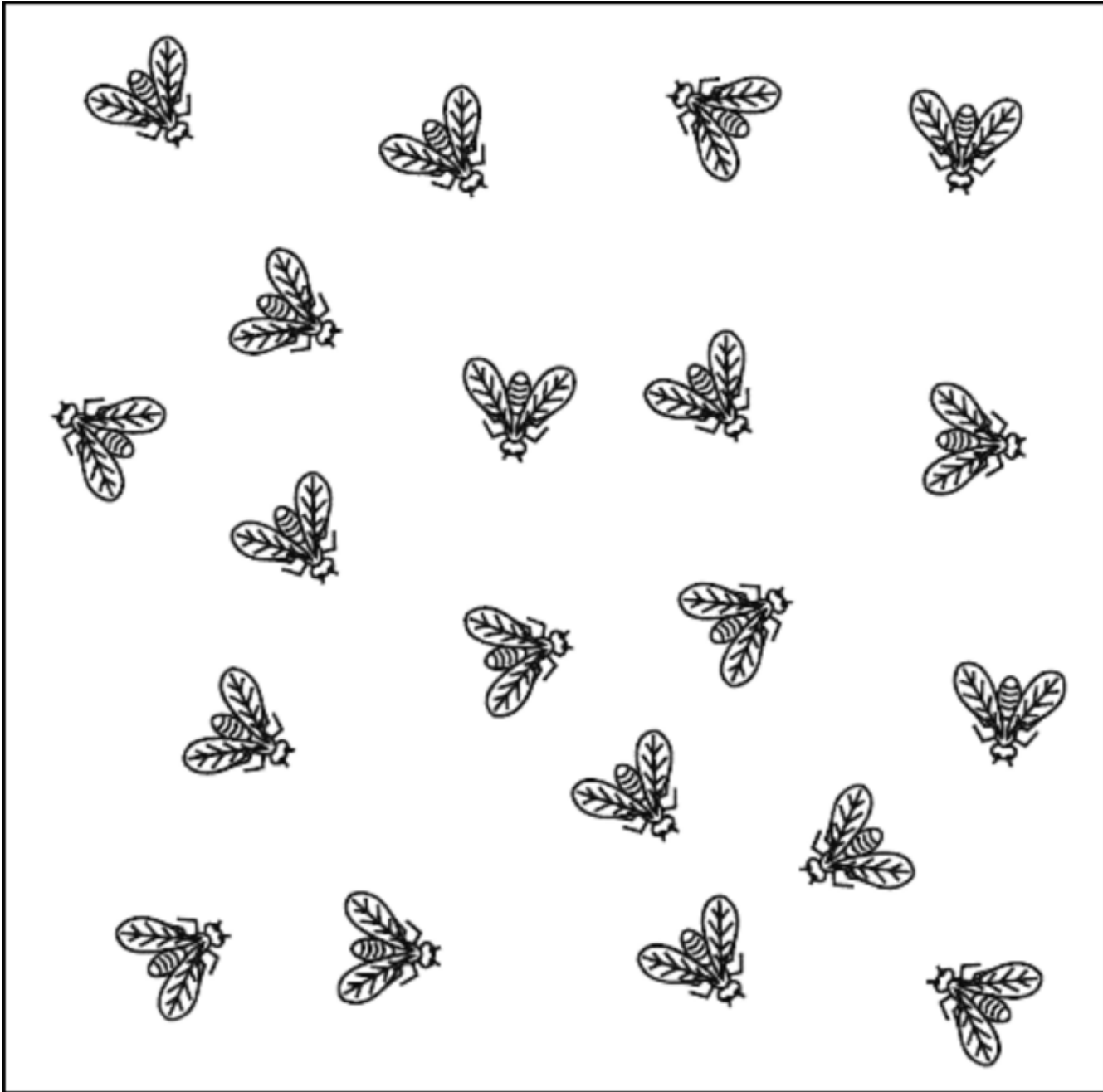

Name: _____

Date: _____

Witness: _____

Score: _____

GOOD BREAK

Objective: To provide cadets the opportunity to lead a timed air rifle marksmanship activity.

Scoring: Targets will be scored by totalling the value for each billiard ball where the centre circle has a pellet hole located in it; additional pellets will be scored as zero.

Equipment Required:

- Air rifle marksmanship equipment,
- Cadet air rifle,
- Air rifle pellets (10 per participant),
- Good Break Target (one per participant),
- Good Break scoresheet,
- Target frame, and
- Stopwatch.

Activity Instructions:

1. Brief the cadets on the activity being conducted including any safety rules or other guidelines pertaining to the activity.
2. Distribute a target to each cadet.
3. Have the cadets write their name and date on the target and attach it to the target frame.
4. Give the cadets 10 pellets to fire.
5. Have the cadets fire a five minute timed relay, in relays, following the commands given by the RSO.
6. Return unused pellets to the pellet controller.
7. Have the cadets retrieve their targets.
8. Score the targets (see above).
9. Allow the cadets to review and keep their targets.

The following are prohibited:

- Alterations, other than those permitted in A-CR-CCP-177/PT-001 Part 4, Section 4, Para 5.3,
- Supports used as a rest for the rifle or the forearm,
- A spotting scope,
- Use of sights not provided with the cadet air rifle, and
- Coaching.

GOOD BREAK TARGET

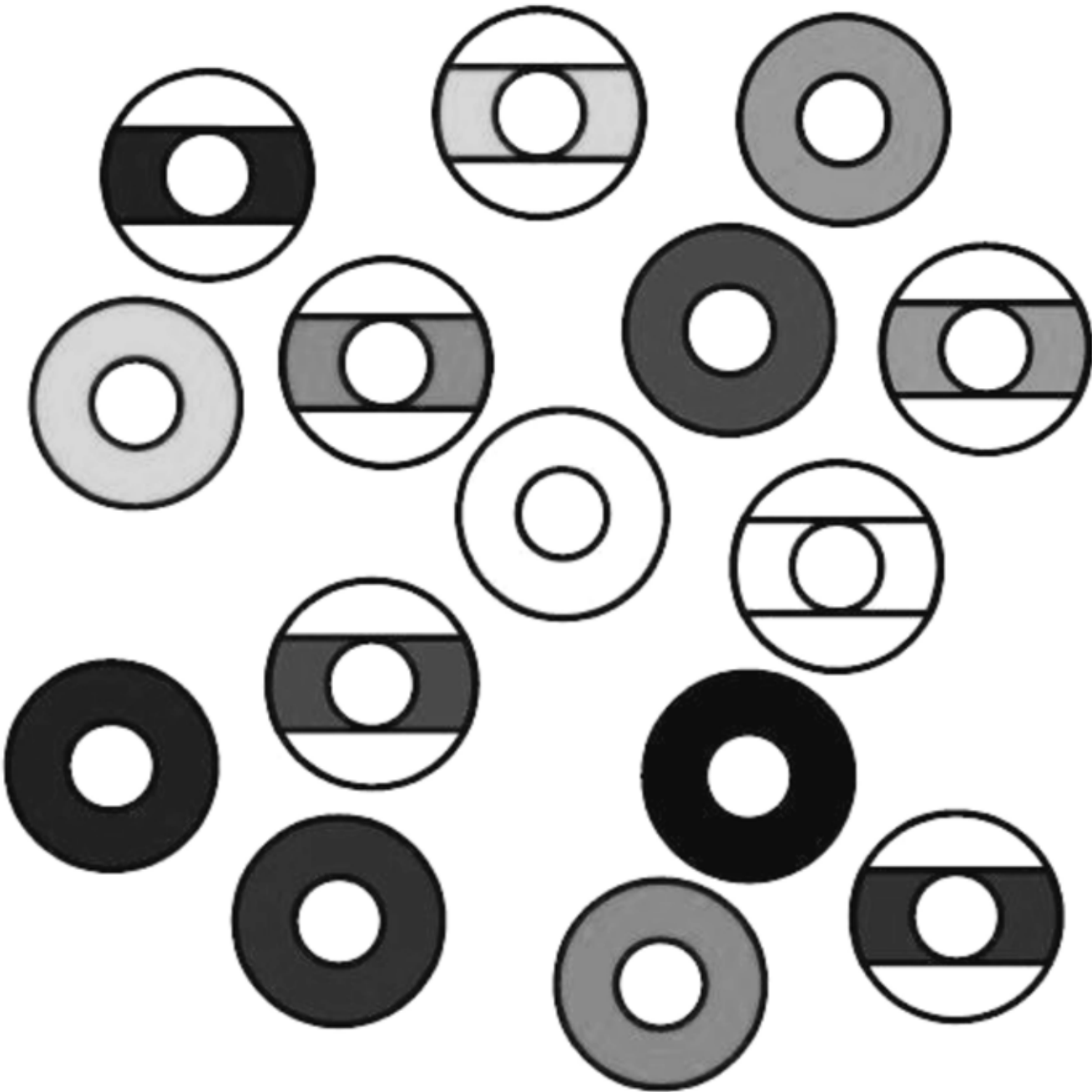

Name:

Date:

Witness:

Score:

GOOD BREAK SCORESHEET

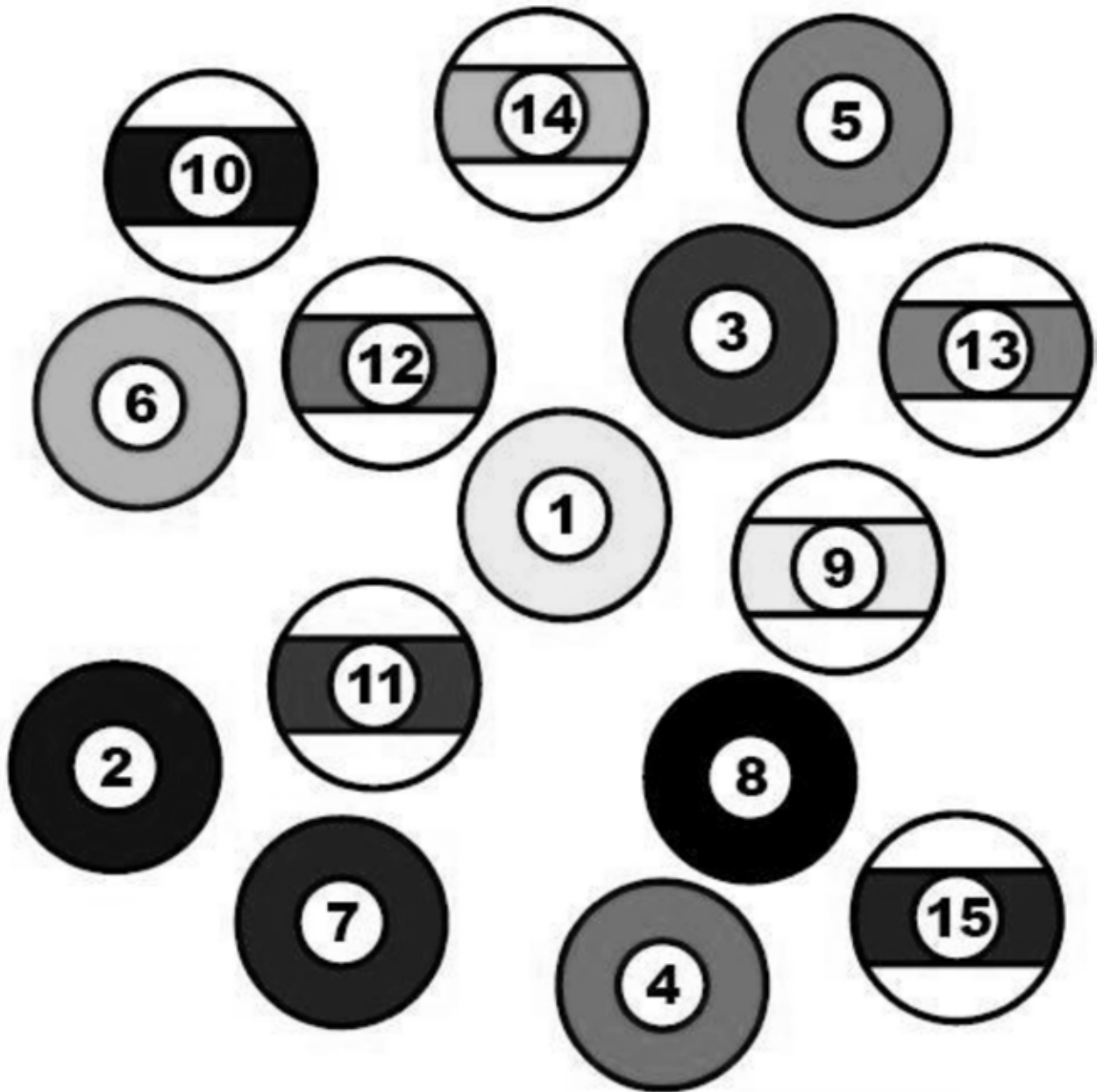

THIS PAGE INTENTIONALLY LEFT BLANK

SIMULATED STAGE 1 CHAMPIONSHIP

Objective: To provide cadets the opportunity to compete in a simulated CCMCS Stage 1 Championship (Match 1.1), intended for team selection by:

- competing as an individual against each other;
- firing at a distance of 10 m;
- firing in the prone unsupported position;
- firing one target per relay;
- loading single pellets only; and
- coaching on the firing line as permitted.

Note: This activity shall be conducted IAW Part 4, Section 3 of A-CR-CCP-177/PT-001, *Canadian Cadet Movement: Cadet Marksmanship Program Reference Manual*.

Scoring: Targets will be scored IAW A-CR-CCP-177/PT-001 *Canadian Cadet Movement: Cadet Marksmanship Program Reference Manual*, to include:

- Each CCM Competition Target has a highest possible score of 100 points (10 diagrams worth 10 points each).
- All pellet holes are scored using the highest value of the scoring ring that it is broken.
- Pellet holes outside the scoring rings are given a value of zero.
- If more than one pellet is fired on a diagram, the pellet hole with the highest value will be discarded until one pellet hole remains on the diagram. A two-point penalty will be applied for each excess pellet hole.
- Only the prescribed number of pellet holes may be fired at each diagram (eg, if two shots were fired at the first diagram, one diagram on the target would remain blank [free of pellet holes]).

Equipment Required:

- Air rifle marksmanship equipment,
- Cadet air rifle,
- Air rifle pellets (10 pellets),
- CCT2001AR853 (CCM Competition Target),
- .177- / .22-scoring magnifier (scoring magnifier),
- Scoring plug,
- Scoring template,
- Target frame,
- Stopwatch.

Optional aids to firing are limited to the following:

- Cadet air rifle sling,
- Marksmanship jacket,
- Marksmanship glove, and
- Hat.

Activity Instructions:

1. Brief the cadets on the activity being conducted including any safety rules or other guidelines pertaining to the activity.
2. Distribute the CCM Competition Target to each cadet.
3. Have the cadets write their name and date on the target and attach it to the target frame.
4. Give the cadets 10 pellets to fire.
5. Have the cadets fire, in relays, following the commands given by the RSO.
6. Give the cadets 15 minutes to complete firing.
7. Have the cadets retrieve their targets.
8. Score the targets using a scoring magnifier and / or scoring template.
9. Allow the cadets to review and keep their targets.

The following are prohibited:

- Alterations, other than those permitted in A-CR-CCP-177/PT-001 Part 4, Section 4, Para 5.3,
- Supports used as a rest for the rifle or the forearm,
- A spotting scope,
- Use of sights not provided with the cadet air rifle, and
- Coaching.

SIMULATED STAGE 2 CHAMPIONSHIP

Objective: To provide cadets the opportunity to compete in a simulated CCMCS Stage 2 Championship (Match 1.2 A), intended for team competition by:

- competing as a team of five competitors;
- firing at a distance of 10 m;
- firing in the prone unsupported position;
- firing two targets per relay;
- firing two relays;
- loading single pellets only; and
- coaching on the firing line as permitted.

Note: This activity shall be conducted IAW Part 4, Section 3 of A-CR-CCP-177/PT-001, *Canadian Cadet Movement: Cadet Marksmanship Program Reference Manual*.

Scoring: Targets will be scored IAW A-CR-CCP-177/PT-001, *Canadian Cadet Movement: Cadet Marksmanship Program Reference Manual*, to include:

- Each member has a highest possible score of 400 points (40 diagrams worth 10 points each).
- The top four competitors will be counted towards the team's highest possible score of 1600 points.
- All shot holes are scored using the highest value of the scoring ring that it is broken.
- Shots outside the scoring rings are given a value of zero.
- If more than the one pellet is fired on a diagram, the shots with the highest value will be discarded until one shot remains on the diagram. A two-point penalty will be applied for each excess shot.
- Only the prescribed number of shots may be fired at each diagram (eg, if two shots were fired at the first diagram, one diagram on the target would remain blank [free of shots]).

Equipment Required:

- Air rifle marksmanship equipment,
- Cadet air rifle,
- Air rifle pellets (40 pellets),
- CCT2001AR853 (air rifle competition target),
- .177- / .22-scoring magnifier (scoring magnifier),
- Scoring plug,
- Scoring template,
- Target frame, and
- Stopwatch.

Activity Instructions:

1. Brief the cadets on the activity being conducted including any safety rules or other guidelines pertaining to the activity.
2. Distribute two CCM Competition Targets to each cadet.
3. Have the cadets write their name and date on the targets and attach them to the target frame.
4. Give the cadets 20 pellets to fire.
5. Have the cadets fire, in relays, following the commands given by the RSO.
6. Give the cadets 30 minutes to complete firing.
7. Have the cadets retrieve their targets.
8. Score the targets using a scoring magnifier and / or scoring template.
9. Allow the cadets to review and keep their targets.
10. Repeat steps 2 to 9.

The following are prohibited:

- Alterations, other than those permitted in A-CR-CCP-177/PT-001 Part 4, Section 4, Para 5.3,
- Supports used as a rest for the rifle or the forearm,
- A spotting scope,
- Use of sights not provided with the cadet air rifle, and
- Coaching.



**COMMON TRAINING
GREEN STAR
INSTRUCTIONAL GUIDE**



SECTION 7

EO C106.02 – CLEAN AND STORE THE CADET AIR RIFLE

Total Time:

30 min

PREPARATION

PRE-LESSON INSTRUCTIONS

Resources needed for the delivery of this lesson are listed in the lesson specification located in A-CR-CCP-701/PG-001, *Green Star Qualification Standard and Plan*, Chapter 4. Specific uses for said resources are identified throughout the instructional guide within the TP for which they are required.

Prior to instructing this lesson the instructor shall:

- review the lesson content, and become familiar with the material; and
- prepare a mock air rifle range to be used in the conduct of the lesson.

PRE-LESSON ASSIGNMENT

Nil.

APPROACH

This lesson will be presented using the demonstration and performance method. The demonstration and performance method was chosen to allow cadets to participate in supervised exploration of practical instructional material. This method provides the instructor the opportunity to introduce the subject matter, demonstrate and explain procedures, and supervise the cadets while they imitate the skill. This method appeals to all learning styles.

INTRODUCTION

REVIEW

Nil.

OBJECTIVES

By the end of this lesson the cadet shall be expected to clean and store the cadet air rifle during a range practice.

IMPORTANCE

Many inaccuracy complaints can be traced back to a dirty bore. Therefore, air rifles must be cleaned and maintained on a regular basis in order to ensure proper operation and sustained accuracy.

Teaching Point 1**Explain and demonstrate the procedure for cleaning the cadet air rifle.**

Time: 15 min

Method: Demonstration and Performance

THE IMPORTANCE OF CLEANING THE AIR RIFLE

No one should attempt to clean a rifle until individual safety precautions have been performed on the rifle, and it is certain that the barrel is clear of any obstructions.

It is important to keep the air rifle clean because a dirty bore will eventually cause accuracy problems. Although air rifles do not suffer from powder deposits as do small bore and large bore rifles, they do experience a build-up of residue in the barrel.

WHEN TO CLEAN THE AIR RIFLE

There are four main times to clean the cadet air rifle:

1. Before firing.
2. After firing.
3. Periodically.
4. Before storage.



Cadets will not actually be cleaning the air rifle during this period of instruction. This may be done after participating in a range practice.

CLEANING PROCEDURE FOR THE AIR RIFLE

When	Action
Before firing	Fire two to three felt cleaning pellets.
After firing	Fire two to three felt cleaning pellets.
Periodically	<ol style="list-style-type: none"> 1. Fire a felt cleaning pellet soaked in SAE 30 motor oil. 2. Wait five minutes. 3. Fire three felt cleaning pellets.
Before storage of three months or more.	<ol style="list-style-type: none"> 1. Fire two to three felt cleaning pellets. 2. Fire one felt cleaning pellet soaked in SAE 30 motor oil. 3. Fire three felt cleaning pellets when taking rifle out of storage.

CONFIRMATION OF TEACHING POINT 1

QUESTIONS

- Q1. What must be done before attempting to clean an air rifle?
- Q2. When are the four times an air rifle must be cleaned?
- Q3. How many felt cleaning pellets are fired before participating in a range practice?

ANTICIPATED ANSWERS

- A1. Individual safety precautions.
- A2. Before firing, after firing, periodically, and before storage for three months or more.
- A3. Two to three cleaning pellets will be fired before participating in a range practice.

Teaching Point 2**Explain and demonstrate the sequence for storing the air rifle.**

Time: 10 min

Method: Demonstration and Performance

STORING THE AIR RIFLE IN THE CASE

The sequence for storing the cadet air rifle is the reverse order of the procedure for removing the air rifle from the case:

1. Ensure the open case is pointed in a safe direction.
2. Close the action (bolt forward and closed).
3. Slide safety rod out of the barrel.
4. Place the rifle in the case in the direction of the arrow on the case.
5. Confirm pumping lever is partially open.
6. Confirm the safety catch is ON.
7. Close the case.

CONFIRMATION OF TEACHING POINT 2

QUESTIONS

- Q1. What position is the bolt in for storage?
- Q2. What direction is the rifle placed in the case?
- Q3. What position is the safety catch placed in for storage?

ANTICIPATED ANSWERS

- A1. Forward and closed.
- A2. In the direction of the arrow on the case.
- A3. ON, with no red showing.

END OF LESSON CONFIRMATION

QUESTIONS

- Q1. What must be done before anyone should attempt to clean an air rifle?
- Q2. What types of problems can be caused by a dirty bore?
- Q3. Before storage cleaning is done when a rifle will be stored for how long?

ANTICIPATED ANSWERS

- A1. They perform individual safety precautions.
- A2. It is important to keep the air rifle clean because a dirty bore will eventually cause accuracy problems.
- A3. Three months or more.

CONCLUSION

HOMEWORK/READING/PRACTICE

Nil.

METHOD OF EVALUATION

The instructor will confirm cadets' ability to clean and store the cadet air rifle at the end of a range practice.

CLOSING STATEMENT

A dirty air rifle and bore will cause accuracy and operation problems. Therefore, air rifles must be cleaned and maintained on a regular basis in order to ensure proper operation and sustained accuracy.

INSTRUCTOR NOTES/REMARKS

Emphasis must be placed on the safety aspects of this lesson.

REFERENCES

A0-027 A-CR-CCP-177/PT-001 D Cdts 3. (2001). *Canadian Cadet Movement: Cadet Marksmanship Programme Reference Manual*. Ottawa, ON: Department of National Defence.

CHAPTER 7
PO 107 – SERVE IN AN ARMY CADET CORPS



ROYAL CANADIAN ARMY CADETS
GREEN STAR
INSTRUCTIONAL GUIDE



SECTION 1

EO M107.01 – PARTICIPATE IN A DISCUSSION ON YEAR ONE TRAINING

Total Time: 30 min

PREPARATION

PRE-LESSON INSTRUCTIONS

Resources needed for the delivery of this lesson are listed in the lesson specification located in A-CR-CCP-701/PG-001, *Green Star Qualification Standard and Plan*, Chapter 4. Specific uses for said resources are identified throughout the instructional guide within the TP for which they are required.

Review the lesson content and become familiar with the material prior to delivering the lesson.

PRE-LESSON ASSIGNMENT

Nil.

APPROACH

An interactive lecture was chosen for this lesson to orient the cadet on the content of green star training and opportunities at the corps.

INTRODUCTION

REVIEW

Nil.

OBJECTIVES

By the end of the lesson the cadet shall be expected to be familiar with the performance objectives (POs) associated with the green star qualification and be familiar with the corps optional training opportunities.

IMPORTANCE

Having an overview of the training opportunities provided to green star cadets prepares new cadets for the training year, allowing them to understand how training fits together and identify areas they are particularly interested in. This overview should excite and energize cadets for the coming year.

Teaching Point 1**Discuss the content and format of green star training.**

Time: 15 min

Method: Interactive Lecture

COMMON TRAINING

There is common cadet training which applies to sea, army and air cadets. POs for these common cadet subjects are as follows:

PO Number and Topic	PO Statement
100 Positive Social Relations for Youth	Participate in <i>Positive Social Relations for Youth</i> Training
101 Citizenship	Perform Individual Acts that Better the Community
102 Community Service	Perform Community Service
103 Leadership	Participate as a Member of a Team
104 Personal Fitness and Healthy Living	Track Participation in Physical Activities
105 Physical Activities	Participate in Physical Activities
106 Marksmanship	Fire the Cadet Air Rifle
107 General Cadet Knowledge	Serve in an Army Cadet Corps
108 Drill	Perform Drill Movements During an Annual Ceremonial Review
111 Biathlon	Participate in Recreational Summer Biathlon Activities

ARMY CADET TRAINING

The expedition is one activity that distinguishes army cadets from the other cadet elements. For army cadets, expedition is defined as “any activity that consists of dynamic travel of no less than 36 hours in duration, where there is a clear goal associated with the activity.” Expedition training in Green Star is supported by the following POs:

PO Number and Topic	PO Statement
121 Field Training	Participate as a Member of a Team During an Overnight Bivouac Field Training Exercise (FTX)
122 Navigation	Identify location Using a Map
123 Hiking	Participate in a Day Hike



Ask the cadets to share what PO they are most interested in and why.



Allow time for cadets to ask questions about the various POs they will experience in Green Star.

Another PO army cadets will participate in is PO 120 (Demonstrate Knowledge of the Organization and Traditions of the Canadian Forces). This PO provides cadets with the knowledge and opportunity to effectively interact with CF members, while promoting an interest therein.

Teaching Point 2**Discuss available optional training at the corps.**

Time: 10 min

Method: Interactive Lecture

OPTIONAL TRAINING AT THE CORPS

Optional training offered at the cadet corps will vary, depending on a number of factors. Some of these opportunities are dependent on the availability and qualification of staff, and resources of the corps. The corps may offer such activities as:

- Cultural education / travel,
- Music (military band and pipes and drums),
- Winter biathlon,
- First-aid,
- Drill teams, and
- Other optional training that the unit and sponsor choose to pursue.



The instructor shall present any information to cadets about the activities that the corps participates in regularly.

CONFIRMATION OF TEACHING POINT 2**QUESTIONS:**

- Q1. What are some of the optional training activities that your corps participates in?
- Q2. What activities would you like to participate in? (The instructor will go around the room, and each cadet will reveal what activity(ies) they are most interested in.)

ANTICIPATED ANSWERS:

- A1. Answers will vary. Answers will include, but are not limited to, cultural education / travel, music, summer and winter biathlon, first-aid, drill teams and anything else that an individual corps may choose to participate in.
- A2. Answers will vary by cadet.

END OF LESSON CONFIRMATION**QUESTIONS:**

- Q1. What are some POs in which only army cadets will train?
- Q2. What are some of the optional training activities in which your corps participates?

ANTICIPATED ANSWERS:

- A1. Any of the following: PO 121 Field Training, PO 122 Navigation and PO 123 Hiking.
- A2. Answers will vary by cadet corps but may include any of the following; cultural education / travel, music, summer and winter biathlon, first-aid, drill teams and anything else that an individual corps may choose to participate in.

CONCLUSION

HOMEWORK/READING/PRACTICE

Nil.

METHOD OF EVALUATION

Nil.

CLOSING STATEMENT

It is important for a first year cadet to know what training they will be participating in to help build interest and entice the cadet to continue in the Cadet Program. Green star cadets should also know what activities and opportunities are available to them through their cadet corps.

INSTRUCTOR NOTES/REMARKS

Nil.

REFERENCES

A2-031 D Cdts. (2003). *CATO 41-01 Royal Canadian army cadet training*. In Cadet Administrative and Training Orders (Vol. 4, 8 pages). Ottawa, ON.

C2-038 0787224596 Henton, M. (1996). *Adventure in the Classroom: Using Adventure to Strengthen Learning and Build a Community of Life-long Learners*. Dubuque, IA: Kendall Hunt Publishing.

C2-039 0825199905 Frank, L.S. (2001). *The caring classroom: Using adventure to create community in the classroom and beyond*. Dubuque, IA: Kendall Hunt Publishing.



ROYAL CANADIAN ARMY CADETS
GREEN STAR
INSTRUCTIONAL GUIDE



SECTION 2

EO M107.02 – IDENTIFY ARMY CADET RANKS AND OFFICER RANKS

Total Time: 30 min

PREPARATION

PRE-LESSON INSTRUCTIONS

Resources needed for the delivery of this lesson are listed in the lesson specification located in A-CR-CCP-701/PG-001, Green Star Qualification Standard and Plan, Chapter 4. Specific uses for said resources are identified throughout the instructional guide within the TP for which they are required.

Review the lesson content and become familiar with the material prior to delivering the lesson.

Photocopy the handout located at Attachment A for each cadet.

PRE-LESSON ASSIGNMENT

Nil.

APPROACH

An in-class activity was chosen for this lesson as it is an interactive way to provoke thought and stimulate interest in the rank structure of the RCAC and of the Canadian Army.

INTRODUCTION

REVIEW

Nil.

OBJECTIVES

By the end of this lesson the cadet shall be expected to correctly identify the rank structure of the Royal Canadian Army Cadets (RCAC), as well as the ranks of Canadian Forces (CF) Army officers.

IMPORTANCE

Being familiar with the ranks of the Army Cadets and officers of the CF will help cadets understand the relationship between cadet ranks and officers at the corps. It will also aid them in interacting effectively with CF members when visiting other CF facilities or bases.

Teaching Point 1**Explain the structure and rank insignia of the RCAC.**

Time: 10 min

Method: In-Class Activity



Army Cadet ranks are derived from those used by the Canadian Army. The similarity will help cadets who understand cadet ranks to identify the ranks of Canadian Army Non-Commissioned Members (NCMs). The exception to this rule is the use of the rank of Lance-Corporal. For more information on Army Cadet Ranks and Promotion Policy, refer to CATO 13-02 (Cadet Rank Promotions).

Provide cadets with the handout at Attachment A as a training aid.

CADET RANKS NON-COMMISSIONED MEMBERS (NCMS)

Rank is a system of grading seniority and command within military organizations. The gold arrows are referred to as “chevrons”. The more chevrons used, the higher the seniority of the individual.

These chevrons are worn on the upper arm, on the right sleeve of the cadet tunic.

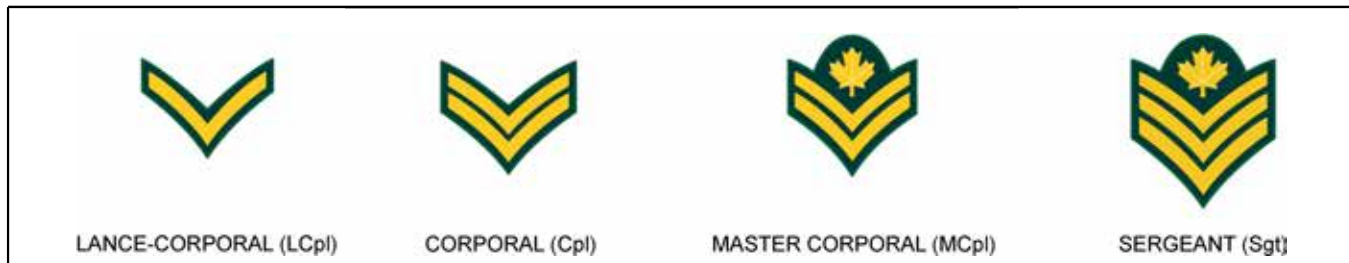

Figure 1 Non-commissioned Members: LCpl – Cpl – MCpl – Sgt

The “Tudor” crown represents the rank of Warrant Officer (WO).

The “Tudor” crown surrounded by a laurel wreath represents the rank of Master Warrant Officer (MWO).

The Canadian Coat of Arms represents the rank of Chief Warrant Officer (CWO).

These ranks are worn low on the sleeve of the right arm of the cadet tunic.



Figure 2 Non-commissioned Members: WO – MWO – CWO



Cadet corps affiliated with Engineer Regiments utilize the term “**sapper**” to designate a LCpl.

Cadet corps affiliated with Armoured Regiments utilize the term “**trooper**” to designate LCpl.

Cadet corps affiliated with the Guard Regiments utilize the term “**guardsman**” to designate LCpl.

In cadet corps affiliated with Artillery Regiments, the following terms are used:

- “**Gunner**” designates lance-corporal;
- “**Bombardier**” designates corporal; and
- “**Master Bombardier**” designates master corporal.



Conduct an activity where the cadets will practice their knowledge of the cadet ranks.

CONFIRMATION OF TEACHING POINT 1

QUESTIONS

- Q1. Which is more senior, the rank of MCpl or Cpl?
- Q2. Describe the MWO rank badge.
- Q3. What other names may be utilized to denote the rank of LCpl?

ANTICIPATED ANSWERS

- A1. MCpl.
- A2. Tudor crown surround by a laurel wreath.
- A3. Gunner, guardsman, trooper, sapper or lance-corporal.

Teaching Point 2

Explain the officer structure and rank insignia of the Army element of the CF.

Time: 15 min

Method: In-Class Activity

COMMISSIONED OFFICERS RANKS

Officers of the CF wear their ranks low on the sleeve of the tunic. The rank insignia consists of a series of wide and narrow gold bars. Officers also wear slip-ons or shoulder boards (Navy) on the epaulettes on their shoulders when wearing shirts, sweaters and jackets. When in field clothing, CADPAT, the rank is worn in the centre of the chest.

SUBORDINATE AND JUNIOR OFFICERS

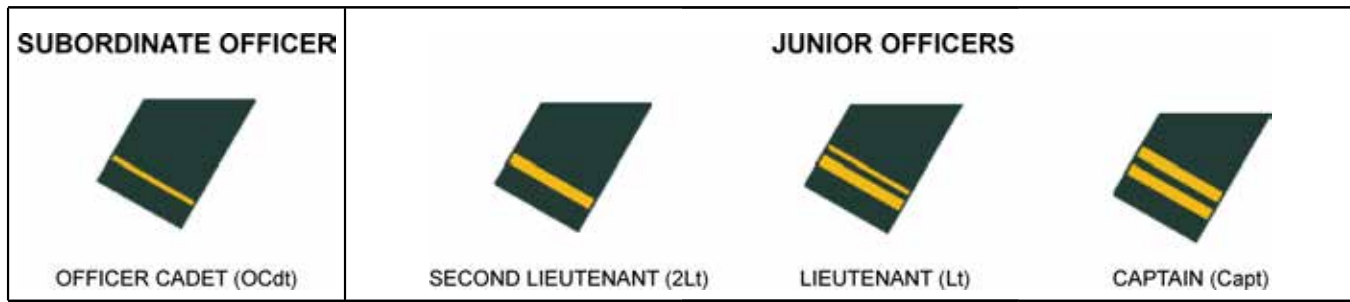

Figure 3 Subordinate and Junior Officers

SENIOR OFFICERS



Figure 4 Senior Officers

GENERAL OFFICERS

General officers wear a wide gold band on the sleeve of the tunic. On their shoulders, they sport slip-ons or shoulder boards with a “Tudor” crown above a crossed sabre and baton that, in turn, has maple leaves below it. The more maple leaves the higher the rank.



Figure 5 General Officers



Conduct an activity where the cadets will practice their knowledge of Army officer ranks.

CONFIRMATION OF TEACHING POINT 2

QUESTIONS

- Q1. What are the senior officer ranks?
- Q2. How many maple leaves are found on the rank of MGen?
- Q3. What rank is assigned the status of subordinate officer?

ANTICIPATED ANSWERS

- A1. Maj, LCol and Col.
- A2. Two.
- A3. OCdt.

END OF LESSON CONFIRMATION

QUESTIONS

- Q1. What is the most senior rank in the cadet NCM structure?
- Q2. What rank has three chevrons with a maple leaf?
- Q3. How would you identify the rank of Colonel?

ANTICIPATED ANSWERS

- A1. CWO.
- A2. Sgt.
- A3. It has four bars on the lower sleeve.

HOMEWORK/READING/PRACTICE

Nil.

METHOD OF EVALUATION

Nil.

CLOSING STATEMENT

The cadet, by identifying the ranks of the RCAC and the officers of the CF, will be able to interact more effectively with the different members of each organization.

INSTRUCTOR NOTES/REMARKS

Nil.

REFERENCES

A0-001 A-AD-265-000/AG-001 DHH 3-2. (2001). *Canadian Forces Dress Instructions*. Ottawa, ON: The Department of National Defence.

A0-009 A-AA-100-000/AA-003 Canadian Forces. (2006). *QR&O, Chapter 3, Section 1, Ranks and Designations of Ranks*. Ottawa, ON: The Department of National Defence.

A2-030 D Cds. (2005). CATO 40-03, *Army Cadet Ranks and Cadet Corps Establishment*. In *Cadet Administrative and Training Orders* (Vol. 4, 5 pages). Ottawa, ON.

CADET AND CANADIAN ARMY OFFICER RANKS

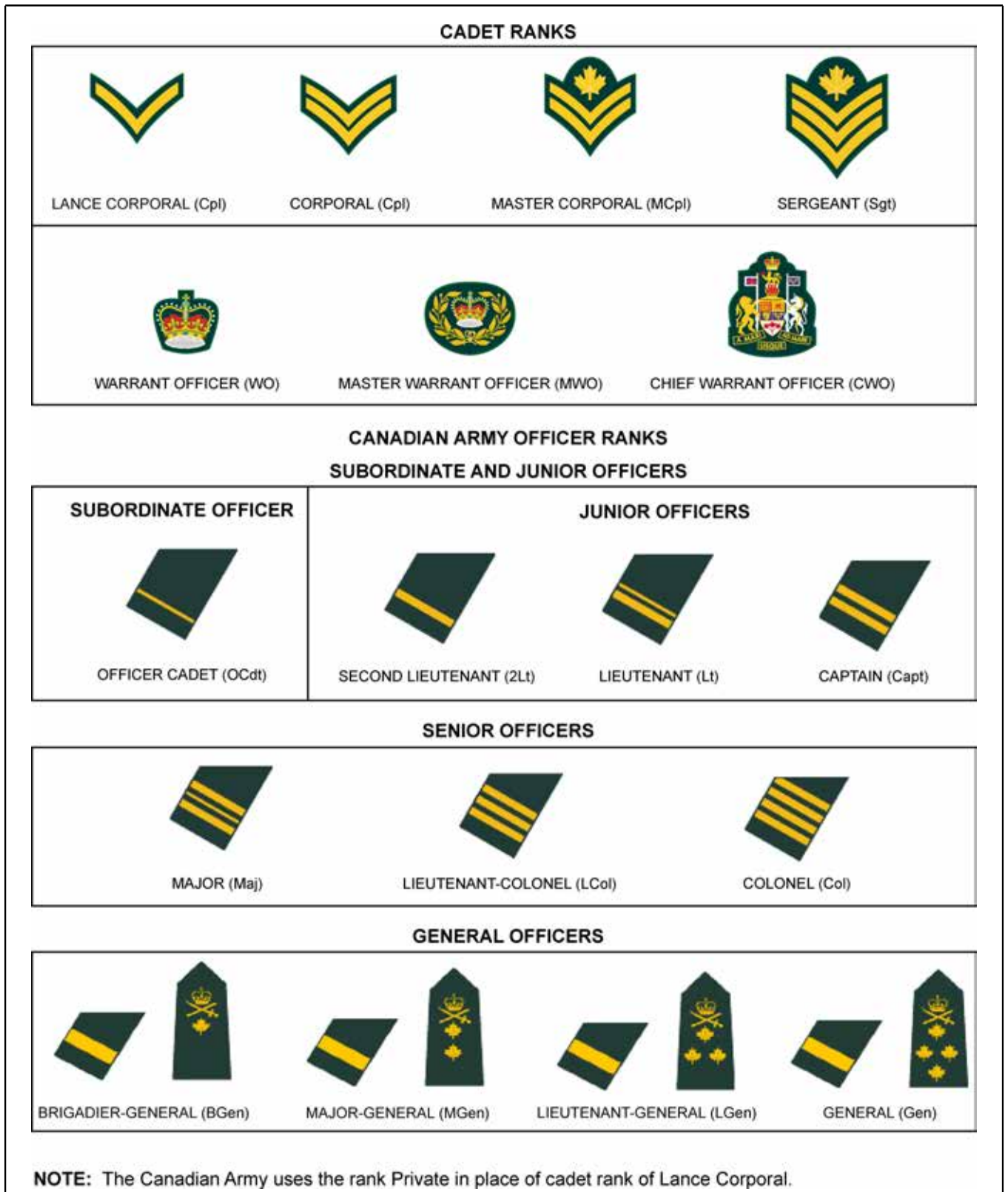

Figure A-1 Cadet and Canadian Army Officer Ranks

THIS PAGE INTENTIONALLY LEFT BLANK



**COMMON TRAINING
GREEN STAR
INSTRUCTIONAL GUIDE**



SECTION 3

EO M107.03 – OBSERVE THE RULES AND PROCEDURES FOR THE PAYING OF COMPLIMENTS

Total Time:

30 min

PREPARATION

PRE-LESSON INSTRUCTIONS

Resources needed for the delivery of this lesson are listed in the lesson specification located in A-CR-CCP-701/PG-001, *Green Star Qualification Standard and Plan*, Chapter 4. Specific uses for said resources are identified throughout the instructional guide within the TP for which they are required.

Review the lesson content and become familiar with the material prior to delivering the lesson.

PRE-LESSON ASSIGNMENT

Nil.

APPROACH

An in-class activity was chosen for TPs 1 and 2 as an interactive way to provoke thought and stimulate interest in procedures for addressing NCOs, subordinate officers and commissioned officers.

An interactive lecture was chosen for TPs 3 and 4 to orient the cadets to regulations for paying compliments inside a building, and to other occasions to pay compliments.

INTRODUCTION

REVIEW

Nil.

OBJECTIVES

By the end of this lesson the cadet shall be expected to know when and where to pay compliments.

IMPORTANCE

Knowledge gained during this lesson will be applied when addressing and interacting with officers and NCOs at the corps and the Cadet Summer Training Centre.

Teaching Point 1**Explain and conduct an activity on the procedure for addressing a cadet NCO or a subordinate officer.**

Time: 10 min

Method: In-Class Activity

ADDRESSING CADET NCOS AND SUBORDINATE OFFICERS

It is important to pay the correct compliments to the appropriate individuals.

When addressing a cadet NCO or a subordinate officer, the cadet will stand at the position of attention. As cadet NCOs and subordinate officers do not hold a commission from the Queen, they are not saluted. Throughout the conversation, the cadet shall address the NCO or subordinate officer by their rank and surname and remain at the position of attention. When the cadet has completed addressing the NCO or officer, they should dismiss themselves appropriately by turning to the right.



The instructor should demonstrate this process prior to moving on to the activity.

ACTIVITYTime: 3 min

OBJECTIVE

To allow cadets to practice the procedures for addressing cadet NCOs and subordinate officers.

RESOURCES

- Army Cadets slip-on ranks, and
- Officer-cadet slip-on rank.

ACTIVITY LAYOUT

- Dependent on time, the cadets can be divided into groups and practice these procedures with their peers.
- If time does not allow, call for volunteers to come to the front of the class. In this case, the instructor shall play the role of the NCO or subordinate officer.
- Have cadets practice the procedures for addressing cadet NCOs and subordinate officers, including:
 - approaching the NCO/subordinate officer and standing at the position of attention;
 - addressing the NCO/subordinate officer by their rank and surname; and
 - dismissal.

SAFETY

Nil.

INSTRUCTOR GUIDELINES

Ensure there is sufficient area to conduct the role-play activity.

CONFIRMATION OF TEACHING POINT 1

QUESTIONS

- Q1. Do cadet NCOs and subordinate officers hold a commission from the Queen?
- Q2. If they do not hold a commission, are they saluted?
- Q3. Name an action the cadet should take while addressing a cadet NCO/subordinate officer.

ANTICIPATED ANSWERS

- A1. No, they do not hold a commission.
- A2. No, they are not saluted.
- A3. Standing at the position of attention, addressing by rank and surname, and dismissing appropriately.

Teaching Point 2**Explain the procedures for addressing a commissioned officer.**

Time: 5 min

Method: In-Class Activity

ADDRESSING COMMISSIONED OFFICERS

When addressing commissioned officers, the same procedures are followed as when addressing NCOs and subordinate officers except a salute shall be given.

The cadet shall stand at the position of attention after approaching the commissioned officer. The cadet will then give the appropriate salute as outlined in A-PD-201-000/PT-000, *Canadian Forces Manual of Drill and Ceremonial*. Throughout the conversation the cadet shall address the commissioned officer by their rank and surname and always remain at the position of attention unless otherwise directed by the commissioned officer. When the cadet has completed addressing the officer, they should again salute and dismiss themselves appropriately.



The instructor should demonstrate this process prior to moving on to the activity.

ACTIVITY

Time: 3 min

OBJECTIVE

To allow cadets to practice the procedures for addressing commissioned officers.

RESOURCES

Army Officers ranks.

ACTIVITY LAYOUT

- Dependent on time, the cadets can be divided into groups and practice these procedures with their peers.
- If time does not allow, call for volunteers to come to the front of the class. In this case, the instructor shall play the role of the commissioned officer.
- Have cadets practice the procedures for addressing commissioned officers, including:
 - approaching the commissioned officer and standing at the position of attention;
 - saluting;
 - addressing the commissioned officer by their rank and surname;
 - saluting prior to dismissal; and
 - dismissal.

SAFETY

Nil.

INSTRUCTOR GUIDELINES

Ensure there is sufficient area to conduct the role-play activity.

CONFIRMATION OF TEACHING POINT 2

QUESTIONS

- Q1. Are you required to salute commissioned officers? Why?
- Q2. When should the commissioned officer be saluted?

ANTICIPATED ANSWERS

- A1. Yes. They hold a commission from the Queen.
- A2. After the officer has been approached and prior to dismissal.

Teaching Point 3

Explain regulations for paying compliments inside a building.

Time: 5 min

Method: Interactive Lecture

PAYING COMPLIMENTS INSIDE A BUILDING

Salutes are not given inside buildings except when on parade, during ceremonial occasions, or when entering and leaving offices. However, cadets shall turn their head and offer a polite greeting when meeting an officer in a common area. It is not customary to wear headdress inside a building.

ENTERING AN OFFICE

When entering an office the cadet shall:

- stand at the position of attention in the doorway;
- salute if wearing headdress and the office occupant holds a commission; and
- politely ask permission to enter the office.

LEAVING AN OFFICE

When leaving an office the cadet shall:

- stand at the position of attention in the doorway;
- salute if wearing headdress and the office occupant holds a commission; and
- depart.



The instructor should demonstrate this process prior to moving on to the activity.



RCAC Level One Handbook, Cadets Canada, 1993

Figure 1 Entering and Leaving an Office

ACTIVITY

Time: 5 min

OBJECTIVE

To allow cadets to practice the procedures for entering and leaving offices.

RESOURCES

Role-play area.

ACTIVITY LAYOUT

- Dependent on time, the cadets can be divided into groups and practice these procedures with their peers.
- If time does not allow, call for volunteers to come to the front of the class. In this case, the instructor shall play the role of the office occupant.
- Have cadets practice the procedures for entering and leaving offices, including:
 - Entering:
 - stand at the position of attention in the doorway when entering;
 - salute if wearing headdress and the office occupant holds a commission; and
 - politely ask permission to enter the office.
 - Leaving:
 - stand at the position of attention in the doorway when leaving the office;
 - salute if wearing headdress and the office occupant holds a commission; and
 - depart.

SAFETY

Nil.

INSTRUCTOR GUIDELINES

Ensure there is sufficient area to conduct the role-play activity.

CONFIRMATION OF TEACHING POINT 3

QUESTIONS

Q1. Name two times or places where compliments are paid inside a building.

ANTICIPATED ANSWERS

A1. Parade square, ceremonial occasions, entering and leaving offices.

Teaching Point 4

Explain other occasions to pay compliments.

Time: 4 min

Method: Interactive Lecture

OTHER OCCASIONS TO PAY COMPLIMENTS

It is appropriate for cadets to salute on different occasions:

- When the Canadian or another foreign national anthem is played.
- When recognizing a commissioned officer who is not in uniform.

- When The National Flag of Canada is being lowered or raised.
- When boarding or disembarking any of Her Majesty's Canadian ships or those of a foreign service, cadets shall pay compliments to the quarterdeck.

CONFIRMATION OF TEACHING POINT 4

QUESTIONS

- Q1. Does one salute when recognizing a commissioned officer out of uniform?
- Q2. Does one pay compliments if the Star Spangled Banner is played?

ANTICIPATED ANSWERS

- A1. Yes, compliments shall be paid.
- A2. Yes, compliments are paid for all national anthems.

END OF LESSON CONFIRMATION

This lesson will be confirmed by verbal questioning.

CONCLUSION

HOMEWORK/READING/PRACTICE

Nil.

METHOD OF EVALUATION

Nil.

CLOSING STATEMENT

The cadets have learned how to address cadet NCOs, subordinate and commissioned officers; how to pay compliments inside a building; and other occasions on which to salute. Knowledge gained during this lesson will be applied when addressing and interacting with officers and NCOs at the corps and at the cadet summer training centre.

INSTRUCTOR NOTES/REMARKS

Nil.

REFERENCES

A0-002 A-PD-201-000/PT-000 National Defence. (2001). *The Canadian Forces Manual of Drill and Ceremonial*. Ottawa, ON: National Defence.

THIS PAGE INTENTIONALLY LEFT BLANK



ROYAL CANADIAN ARMY CADETS
GREEN STAR
INSTRUCTIONAL GUIDE



SECTION 4

EO M107.04 – STATE THE AIM AND THE MOTTO OF THE ARMY CADET PROGRAM

Total Time: 30 min

PREPARATION

PRE-LESSON INSTRUCTIONS

Resources needed for the delivery of this lesson are listed in the lesson specification located in A-CR-CCP-701/PG-001, *Green Star Qualification Standard and Plan*, Chapter 4. Specific uses for said resources are identified throughout the instructional guide within the TP for which they are required.

Review the lesson content and become familiar with the material prior to delivering the lesson.

PRE-LESSON ASSIGNMENT

Nil.

APPROACH

An interactive lecture was chosen for this lesson to orient the cadets to the aim and motto of the Cadet Program.

INTRODUCTION

REVIEW

Nil.

OBJECTIVES

By the end of the lesson the cadet shall be expected to be familiar with the mission and vision of the Cadet Program, and state the aim and motto of the Army Cadet Program.

IMPORTANCE

Knowing the aim and the motto of the Army Cadet Program is for any cadet. This information will give a better understanding of how the Cadet Program can help them develop both as a cadet and an individual.

Teaching Point 1

State the mission of the Cadet Program.

Time: 5 min

Method: Interactive Lecture



Conduct the brainstorming activity before stating the mission.



According to the Canadian Oxford Dictionary (2001), mission can be defined as a journey with a purpose. The mission of the Cadet Program details **what** the Cadet Program hopes to achieve through its training and **how it hopes to do so**.

ACTIVITY

Time: 4 min

OBJECTIVE

The objective of the activity is for the cadets to brainstorm ideas about what they think the Cadet Program mission is.

RESOURCES

- Flipchart paper.
- Flipchart markers.

ACTIVITY LAYOUT

- Separate the class into two groups.
- Give each group a piece of flipchart paper and a marker.
- Direct each group to brainstorm ideas about what they think the mission (or objective) of the Cadet Program is.
- Give the groups two minutes to complete this activity.
- After the two minutes, have each group present their ideas.
- Finish the activity by outlining the definition as written in this teaching point.

SAFETY

Instructor(s) will supervise cadets during the activity.

INSTRUCTOR GUIDELINES

- During the activity the instructor will monitor the cadets' progress and ensure all members of the class are participating.
- The instructor will answer any questions the cadets may have.

MISSION

The mission of the Cadet Program is to contribute to the development and preparation of youth for the transition to adulthood, enabling them to meet the challenges of modern society, through a dynamic, community-based program.

CONFIRMATION OF TEACHING POINT 1

QUESTIONS

Q1. What is the mission of the Cadet Program?

ANTICIPATED ANSWERS

A1. The mission of the Cadet Program is to contribute to the development and preparation of youth for the transition to adulthood, enabling them to meet the challenges of modern society, through a dynamic, community-based program.

Teaching Point 2

State the vision of the Cadet Program.

Time: 5 min

Method: Interactive Lecture



Conduct the brainstorming activity before stating the vision.

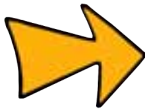

According to the Canadian Oxford Dictionary (2001), vision can be defined as the act or faculty of seeing. The vision of the Cadet Program states what it sees the Cadet Program **being**, and **how** it hopes to get there.

ACTIVITY

Time: 4 min

OBJECTIVE

The objective of this activity is for the cadets to brainstorm ideas about what they think the Cadet Program vision is.

RESOURCES

- Flipchart paper.
- Flipchart markers.

ACTIVITY LAYOUT

- Separate the class into two groups.
- Give each group a piece of paper and a marker.

- Direct each group to brainstorm ideas about what they think the vision of the Cadet Program is.
- Give the groups two minutes to complete this activity.
- After the two minutes, have each group present their ideas.
- Finish the activity by outlining the definition as written in this teaching point.

SAFETY

The instructor will supervise the cadets' during the activity.

INSTRUCTOR GUIDELINES

- During the activity the instructor will monitor the cadets progress and ensure all members of the class are participating.
- The instructor will answer any questions the cadets may have.

VISION

The vision of the Cadet Program is a relevant, credible and proactive youth development organization, offering the program of choice for Canada's youth, preparing them to become the leaders of tomorrow through a set of fun, challenging, well organized and safe activities.

CONFIRMATION OF TEACHING POINT 2

QUESTIONS

Q1. What is the vision of the Cadet Program?

ANTICIPATED ANSWERS

A1. The vision of the Cadet Program is a relevant, credible and proactive youth development organization, offering the program of choice for Canada's youth, preparing them to become the leaders of tomorrow through a set of fun, challenging, well organized and safe activities.

Teaching Point 3

Describe the aim of the Cadet Program.

Time: 10 min

Method: Interactive Lecture



The aim of the Cadet Program is to:

- develop in youth the attributes of good citizenship and leadership;
- promote physical fitness; and
- stimulate the interest of youth in the sea, land and air activities of the Canadian Forces (CF).

DEVELOP IN YOUTH THE ATTRIBUTES OF GOOD CITIZENSHIP AND LEADERSHIP

The Cadet Program aims to assist in the development of cadets as good citizens and leaders.

Through citizenship and community services activities, the cadet develops an appreciation for community membership and involvement within cadet, local, regional, provincial, national and global communities. Cadets'

active involvement will have a positive impact on local communities, which will contribute to community strength and vibrancy.

Through leadership activities, cadets develop interpersonal skills and assume responsibility as effective team members, leaders and dynamic coaches. They will develop the ability to conduct themselves in an ethical and socially responsible way.

PROMOTE PHYSICAL FITNESS

The Cadet Program aims to promote physical well-being. Cadets develop an understanding of the benefits of fitness and a healthy lifestyle. This understanding, combined with on-going participation in fitness activities, aids in the development of positive attitudes and behaviours that build resiliency within cadets and enable them to meet challenges.

STIMULATE THE INTEREST OF YOUTH IN THE SEA, LAND AND AIR ACTIVITIES OF THE CF

The Cadet Program aims to expose youth to the sea, land and air activities of the CF. Cadets develop elemental skills through introduction and interaction with their respective CF communities. The Cadet Program educates and promotes liaison with civilian maritime, adventure and aviation communities. These combined experiences and interactions are essential to the unique identity of the sea, army and air cadet organizations. Also, they distinguish the Cadet Program as a whole from other youth development programs.

CONFIRMATION OF TEACHING POINT 3

QUESTIONS

- Q1. What is the aim of the Cadet Program?
- Q2. How does the Cadet Program promote physical fitness?
- Q3. How does the Cadet Program stimulate an interest in the sea, land and air activities of the Canadian Forces?

ANTICIPATED ANSWERS

- A1. Develop in youth the attributes of good citizenship and leadership, promote physical fitness and stimulate the interest of youth in the sea, land and air activities of the CF.
- A2. The Cadet Program aims to promote physical well-being. Cadets develop an understanding of the **benefits of fitness** and a healthy lifestyle. This understanding, combined with on-going **participation in fitness activities**, aids in the development of **positive attitudes** and behaviours that build resiliency within cadets and enable them to meet challenges.
- A3. The Cadet Program aims to expose youth to the sea, land and air activities of the CF. Cadets develop elemental skills through introduction and interaction with their respective CF communities. The Cadet Program educates and promotes liaison with civilian maritime, adventure and aviation communities. These combined experiences and interactions are essential to the unique identity of the Sea, Army and Air Cadet Organizations. Also, they **distinguish the Cadet Program** as a whole from other youth development programs.

Teaching Point 4

State the Motto of the Army Cadet Program.

Time: 3 min

Method: Interactive Lecture

MOTTO

The motto of the Army Cadet Program is, "*Acer Acerpori*." Acer Acerpori is a latin term which means "as the maple, so the sapling."



The maple leaf is a traditional symbol of Canada, and the crown signifies allegiance to Her Majesty the Queen. The motto ACER ACERORI is Latin. "ACER" is the maple tree. "ACERPORI" is literally a "little boy maple"- a sapling. The ending "I" on "ACERPORI" means "come from". Literally the motto means "from the little boy maple comes the maple." We translate it "As the maple, so the sapling."

CONFIRMATION OF TEACHING POINT 4

QUESTIONS

Q1. What is the motto of the Army Cadet Program?

Q2. What does "*Acer Acerpori*" mean?

ANTICIPATED ANSWERS

A1. *Acer Acerpori*.

A2. "As the maple, so the sapling."

END OF LESSON CONFIRMATION

ACTIVITY

Time: 5 min

OBJECTIVE

The objective of this activity is to confirm the teaching points of the lesson. Cadets will be required to assemble puzzles of the mission, vision, aim and motto of the Army Cadet Program.

RESOURCES

- Puzzles contained at Annex A.
- Envelopes.

ACTIVITY LAYOUT

- Using the puzzles in Annex A, cut each puzzle and place each into a separate envelope.
- Separate the class into four groups.
- Give each group an envelope with a puzzle in it.

- Direct each group to piece together the puzzle in the envelope.
- When the puzzles are complete, have a member of each group read out what their puzzle says.
- Finish the activity by confirming each puzzle again.

SAFETY

- The instructor shall supervise the cadets during the activity.

INSTRUCTOR GUIDELINES

- During the activity the instructor will supervise the cadets' progress and ensure all members of the class are participating.
- The instructor will answer any questions the cadets may have.

CONCLUSION

HOMEWORK/READING/PRACTICE

Nil.

METHOD OF EVALUATION

Nil.

CLOSING STATEMENT

The aims, mission, vision and motto of the Army Cadet Program provide the cadet with a greater understanding of what it means to be an Army Cadet. The tenets of aim and motto will contribute to the development of a sense of pride in belonging to the Army Cadet Program.

INSTRUCTOR NOTES/REMARKS

Nil.

REFERENCES

A0-010 Cdts. (1999). CATO 11-03, *Cadet Program Mandate*. In *Cadet Administrative and Training Orders* (Vol. 1). Ottawa, ON.

C2-040 The Army Cadet League of Canada. (2006). *Policy 3.1: Aim of the Canadian Cadet Organizations*. Retrieved 25 May 2006, from http://www.armycadetleague.ca/templates/pdf/refmanual/english/pol_3_1.pdf.

THIS PAGE INTENTIONALLY LEFT BLANK

PUZZLES

**THE MISSION OF THE CADET
PROGRAM IS TO CONTRIBUTE
TO THE DEVELOPMENT AND
PREPARATION OF YOUTH FOR
THE TRANSITION TO ADULTHOOD,
ENABLING THEM TO MEET THE
CHALLENGES OF MODERN
SOCIETY, THROUGH A DYNAMIC,
COMMUNITY-BASED PROGRAM.**

**A RELEVANT, CREDIBLE
AND PROACTIVE YOUTH
DEVELOPMENT ORGANIZATION,
OFFERING THE PROGRAM OF
CHOICE FOR CANADA'S YOUTH,
PREPARING THEM TO BECOME
THE LEADERS OF TOMORROW
THROUGH A SET OF FUN,
CHALLENGING, WELL-ORGANIZED
AND SAFE ACTIVITIES.**

**DEVELOP IN YOUTH THE
ATTRIBUTES OF GOOD
CITIZENSHIP AND LEADERSHIP.**

PROMOTE PHYSICAL FITNESS.

**STIMULATE THE INTEREST OF
YOUTH IN THE SEA, LAND AND
AIR ACTIVITIES OF THE
CANADIAN FORCES.**

**ACER
ACERPORI**

“AS THE MAPLE, SO THE SAPLING”



ROYAL CANADIAN ARMY CADETS
GREEN STAR
INSTRUCTIONAL GUIDE



SECTION 5

EO M107.05 – WEAR THE ARMY CADET UNIFORM

Total Time: 60 min

PREPARATION

PRE-LESSON INSTRUCTIONS

Resources needed for the delivery of this lesson are listed in the lesson specification located in A-CR-CCP-701/PG-001, *Green Star Qualification Standard and Plan*, Chapter 4. Specific uses for said resources are identified throughout the instructional guide within the TP for which they are required.

Review the lesson content and become familiar with the material prior to delivering the lesson.

PRE-LESSON ASSIGNMENT

Nil.

APPROACH

An interactive lecture was chosen for TPs 1, 5, and 6 to orient the cadets to the rules and responsibilities and orders of dress for the cadet uniform.

A demonstration was chosen for TPs 2 – 4 as it allows the instructor to explain and demonstrate the proper way in which to wear the various headdresses and pieces of clothing on the upper and lower body.

INTRODUCTION

REVIEW

Nil.

OBJECTIVES

By the end of this lesson the cadet shall be expected to properly wear the Army Cadet uniform to the standard set forth in CATO 46-01, *Royal Canadian Army Cadets Dress Instructions*.

IMPORTANCE

The cadet uniform is highly recognizable so the standard of personal dress, appearance and grooming shall be such as to reflect credit on the individual, as well as on the Canadian Cadet Organization (CCO).

Teaching Point 1

Explain general rules and responsibilities for the cadet uniform.

Time: 5 min

Method: Interactive Lecture

OCCASIONS TO WEAR THE UNIFORM

The Army Cadet uniform must be worn when:

- Attending training or proceeding to or from a place of training unless the corps CO gives directives to the contrary.
- Proceeding to or from a CSTC.
- Attending ceremonies or functions at which the wearing of the uniform is appropriate and authorized by the CO of the corps or CSTC.

RESPONSIBILITY FOR THE ARMY CADET UNIFORM

When given an Army Cadet uniform:

- all cadets are responsible for its care, cleaning, custody and return at the end of cadet service;
- replacement of worn uniform parts shall be at public expense where reasonable care has been taken with the uniform;
- issued uniform parts shall not be altered or modified to obtain a reasonable fit; and
- badges shall be sewn on the uniform neatly using thread that blends with the badge and uniform. Badges shall not be glued.

GENERAL APPEARANCE OF THE UNIFORM

In caring for the cadet uniform, the cadet shall:

- ensure it is free from lint and dirt;
- polish metal pieces where applicable;
- ensure the badges are properly affixed to the uniform using thread that blends with the badge and uniform;
- clip any loose threads that may appear; and
- perform any routine maintenance that may be required to keep the uniform sharp and in good repair.

CONFIRMATION OF TEACHING POINT 1

QUESTION

- Q1. Do cadets have to wear their uniform when proceeding to and from a CSTC?
- Q2. Are cadets responsible for paying for their uniforms?
- Q3. True or false: Badges shall be sewn on the uniform neatly using threads that blend with the badge and uniform.

ANTICIPATED ANSWERS

- A1. Yes.
 A2. No.
 A3. True.

Teaching Point 2

Explain and demonstrate the correct manner in which to wear headdress.

Time: 5 min

Method: Demonstration



Instructors are to explain and demonstrate how to wear each item of clothing.

BERET

The Army Cadet beret shall be worn as follows:

- the beret is placed evenly on the head with the sweat-band 2.5 cm above the eyebrows;
- the badge is centred over the left eye;
- the crown of the beret is pulled downward to the right and rear; and
- drawstrings are tacked inside the gap of the sweat-band.

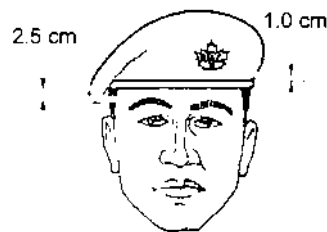

Royal Canadian Army Cadet Dress Instructions

Figure 1 Wearing the Beret



Royal Canadian Army Cadet Dress Instructions

Figure 2 Side View of Beret

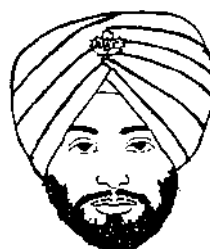

Royal Canadian Army Cadet Dress Instructions

Figure 3 Turban

BERET INSIGNIA

Insignia shall be worn on the beret centred on the built-in back plate with the base of the badge 1 cm above the band. For highland dress, the badge can be centred on the built-in back plate of the left side of the Glengarry, Balmoral or Caubeen.



The turban is worn in a low, Sikh conventional manner, with the final winding right over left on the forehead. The cap badge is worn centred on the front of the turban. More information on Sikh order of dress is located in CATO 46-01, Annex C.



Royal Canadian Army Cadet Dress Instructions

Figure 4 RCAC Insignia for Beret

Royal Canadian Army Cadet Dress Instructions Care of the beret includes:

- ensuring that it is free from lint and dirt;
- polishing the badge when required; and
- washing the leather sweat-band when required.

WIDE BRIMMED TAN SUMMER HAT

The wide brimmed tan summer hat may be worn during summer activities for which the beret is not suitable.

TOQUE

The toque may be worn outside when weather conditions dictate.



Berets can be green, scarlet, black or maroon based on what the affiliated unit wears, and provided that the CO of the affiliated unit has given permission for it to be worn.

CONFIRMATION OF TEACHING POINT 2

QUESTIONS

- Q1. Over which eye is the beret centred?
- Q2. How far is the insignia hat badge worn above the band on the beret?
- Q3. What are some things that a cadet must do to care for their beret?

ANTICIPATED ANSWERS

- A1. The beret is centred over the left eye.
- A2. 1 cm above the band.
- A3. Any of the following:
- Ensuring that it is free from lint and dirt;
 - Polishing the badge when required; and
 - Washing the leather sweat band when required.

Teaching Point 3

Explain and demonstrate the correct way to wear and care for the clothing on the upper body.

Time: 12 min

Method: Demonstration



The instructor will explain and demonstrate how to wear each item of clothing.

INSIGNIA

Insignia, Shoulder Title RCAC or Insignia, Affiliated Unit. Shall be worn on both sleeves of the cadet jacket



Royal Canadian Army Cadet Dress Instructions

Figure 5 RCAC Shoulder Insignia

Insignia, Cadet, Maple Leaf. Shall be worn on both sleeves of all authorized cadet uniform jackets, except the combat uniform jacket worn by staff cadets at a CSTC. Must be worn on the left breast of the all-season jacket.



Royal Canadian Army Cadet Dress Instructions

Figure 6 Insignia, Maple Leaf

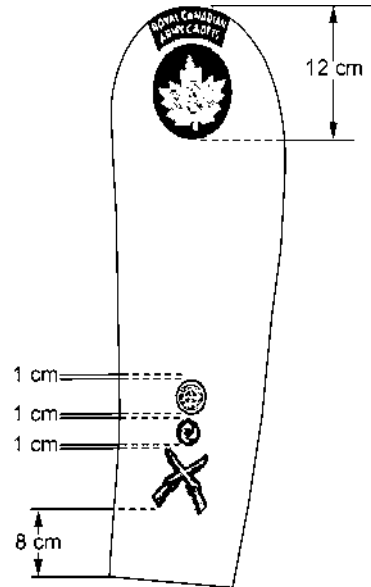

Royal Canadian Army Cadet Dress Instructions

Figure 7 Placement on Jacket

Cadet Slip-on. Shall be worn with the short sleeve orders of dress and overcoats at cadet corps and by staff cadets on all orders of dress at CSTC. When participating in field training, the wearing of rank slip-ons is authorized only for the Field Training Uniform and the Army Cadet League uniform. Slip-ons are to be worn only when the entire uniform is worn.

Cadet Armlet. May be worn (at the discretion of the CO) by staff cadets holding training appointments at a CSTC. The armlet shall contain the RCAC shoulder title badge and the appropriate acting rank badge.

SHIRTS

Shirt, Cadet, Short Sleeve. May be worn with tie, ascot or open neck, with or without jacket. Rank slip-ons shall be worn with the short sleeve shirt.

Undershirt. The olive green cotton T-shirt may be worn with the appropriate orders of dress.

Grey Sports T-shirt. Shall be worn tucked inside the sports shorts during physical activities.

White Undershirt. Cotton shirt which may be worn with any order of dress. The undershirt shall not be visible at the neck opening.

SWEATER AND JACKETS

Sweater, Turtleneck, Long Sleeve. Sweaters may be worn with or without the jacket, but the jacket shall be worn when going to and from the corps location. Sleeves shall not be rolled or pushed up the arm.

Uniform Jacket. The jacket shall be worn fully buttoned except the top button. Sleeves shall be rolled pressed with no creases. Jackets may be removed in buildings and offices when authorized.

Jacket Belt. Shall be worn so as the excess of the belt, once attached, is on the same side as the buttonhole flap. The buckle shall be adjusted so that the excess of the belt is not more than 8 cm.

All-season Jacket. May be worn year round when weather conditions dictate. RCAC crest must be worn on the left breast of the all-season jacket. The liner and the exterior jacket may be worn separately or as a set.

Rank slip-ons shall be worn on both. Medals, ribbons and sashes may be worn on the all-season jacket for outdoor parades.

ACCESSORIES

Necktie. Shall be knotted neatly using a Windsor or four-in-hand knot and shall be kept tight. When the jacket is removed, the tie shall not be tucked into the shirt, unless for safety reasons.



Royal Canadian Army Cadet Dress Instructions

Figure 8 Windsor Knot



Royal Canadian Army Cadet Dress Instructions

Figure 9 Four-in-Hand Knot

Nametag. Can be obtained locally. The standard cadet name tag shall be detachable, made of black and white laminated plastic plate 6.3 cm in length and 1.2 cm in height, inscribed with white lettering 0.6 cm high, and shall indicate the surname of the cadet only.

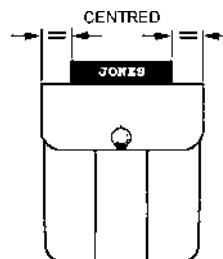

Royal Canadian Army Cadet Dress Instructions

Figure 10 Right Breast Pocket

Sash. Cadet CWO's, MWO's, WO's and Sgt's are authorized to wear a sash, provided it respects the affiliated unit's dress regulations. Army sashes are crimson or scarlet depending on the rank. The sash is a parade accessory that can be worn at the local unit. The sash is only authorized at CSTC's or when on exchanges on the authority of the CO.

Black Wool Gloves. May be worn when weather dictates, or shall be worn when ordered.

Black Mitts. Plain black civilian pattern mitts may be worn with the overcoat, parka or all-season jacket during winter dress periods and when weather conditions dictate.

CONFIRMATION OF TEACHING POINT 3

QUESTIONS

- Q1. True or false: Shoulder insignia are worn on both sleeves.
- Q2. Can any cadet wear the insignia of their affiliated unit when they want?
- Q3. The nametag is centred over which breast pocket?

ANTICIPATED ANSWERS

- A1. True.
- A2. No, cadets (the Cadet Corps) must have permission from the CO of the affiliated unit to wear insignia of that affiliated unit.
- A3. The right breast pocket.

Teaching Point 4

Explain and demonstrate the correct way to wear and care for clothing on the lower body.

Time: 10 min

Method: Demonstration



The instructor will explain and demonstrate how to wear each item of clothing

TROUSERS/BELT/SHORTS

Trousers. Will be pressed without starch so as to have creases down the centre of each leg. Creases shall extend from the top of the leg to the bottom. The length of the trousers should extend to the third eyelet of the ankle boot.

Trousers/Slacks Belt. The trousers/slacks shall be worn with a black belt. The CO may authorize the RCAC belt buckle.

Grey Sport Shorts. Shall be worn at the waist, and must not allow for the underwear to be visible.

FOOTWEAR

Grey Wool Socks. Shall be worn with boots and running shoes. If a cadet suffers from a recognized allergy to wool, grey or black cotton or nylon socks may be worn.

Running Shoes. Shall be worn as directed by the cadet corps or the CSTC CO.

Boots. Shall be laced across horizontally from side to side. Boots shall not be modified by any type of metal cleats, hobnails or other metal attachments to the heel or sole. No varnish other than shoe polish can be used to shine the boots.

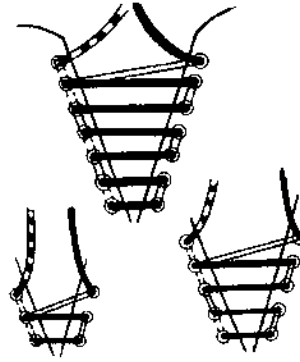

Royal Canadian Army Cadet Dress Instructions

Figure 11 Lacing of Boots

Boots should be cared for by:

- cleaning the welts with an old toothbrush and black boot polish;
- using a soft cloth wrapped around the index finger, ensuring it is flat against the pad of the finger without any wrinkles;
- dampening the end of the cloth and applying a moderate amount of black boot polish;
- applying the polish to the boot in a steady, light circular motion, starting with larger circles to cover the area of the boot and using smaller circles, continuously working the polish into the boot;
- continuing to rub polish with a circular motion until the circles can no longer be seen; and
- breathing on the boot often to help work the polish into the boot.

CONFIRMATION OF TEACHING POINT 4

QUESTIONS

- Q1. How long should trousers be?
- Q2. Must all cadets wear grey wool socks?
- Q3. How are ankle boots laced?

ANTICIPATED ANSWERS

- A1. Trousers should go down to the third eyelet on the boot.
- A2. Yes, unless they have a recognized allergy to wool.
- A3. They are laced horizontally from side to side.

Teaching Point 5

Explain and demonstrate aspects of personal appearance.

Time: 10 min

Method: Interactive Lecture

GENERAL

Cadets in uniform shall be well groomed with footwear cleaned and shined. The uniform shall be clean and properly pressed at all times. In particular, buttons, fasteners and zippers shall be kept closed. Pockets shall

not be bulged; items such as glasses, sunglasses, glasses cases, pens, pencils, key-rings or paper shall not be visibly extended nor protrude from pockets or be suspended from waist belts or pockets.

HAIRSTYLES

Hair on the head shall be neatly groomed and conservatively styled. The length, bulk and style of hair shall not preclude the proper wear of the beret. In particular, style and colour shall not be bizarre, bleached, exaggerated or unusual in appearance. Unusual colours such as green, bright red, orange, purple, etc., are not permitted. Hair must be secured or styled back to reveal the face and any accessories used to secure or control hairstyles shall be as unobtrusive as possible. Hair ornaments shall not be worn, except for female cadets conservative barrettes, which are to blend with the hair colour.

Male Hairstyles. Male cadets' hair shall be taper trimmed at the back, sides, and above the ears to blend with the hairstyle. It shall be no more than 15 cm in length and sufficiently short that, when the hair is groomed and beret is removed, no hair shall touch the ears or fall below the top of the eyebrows.

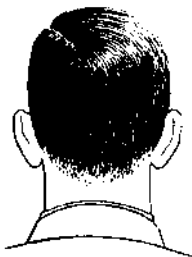

Royal Canadian Army Cadet Dress Instructions

Figure 12 Back View of Hair

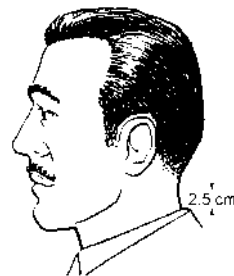

Royal Canadian Army Cadet Dress Instructions

Figure 13 Side View of Hair

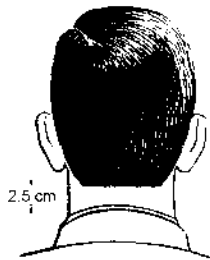

Royal Canadian Army Cadet Dress Instructions

Figure 14 Measurement of Hair

Sideburns. Sideburns shall not extend below a line horizontally bisecting the ear, and shall be squared off horizontally at the bottom edge and taper trimmed to conform to the overall hairstyle.

Moustaches. When moustaches are worn, the unshaven portion of the face shall not extend outwards beyond the corners of the mouth. Moustaches should be kept neatly trimmed, not greater than 2 cm in bulk, not to extend below the corners of the mouth and not protrude beyond the width of the mouth.

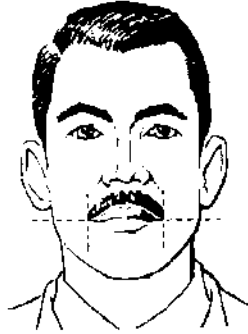

Royal Canadian Army Cadet Dress Instructions

Figure 15 Measurement of Moustache

Beards. Beards shall not be worn except for those cadets who are adherents of the Sikh religion, or cadets with recognized medical problems preventing them from shaving. In the latter case, a note from a medical practitioner is required.

Female Hairstyles. Hair shall not extend below the edge of the shirt collar. Exaggerated styles, including those with excessive fullness or extreme height, are not authorized.

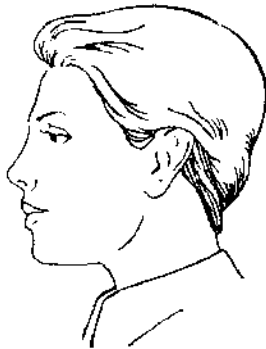

Royal Canadian Army Cadet Dress Instructions

Figure 16 Short Hairstyle

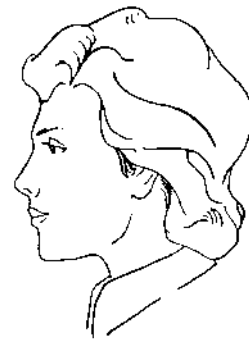

Royal Canadian Army Cadet Dress Instructions

Figure 17 Curled Hairstyle

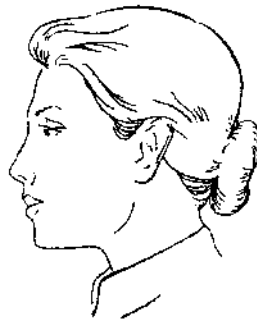

Royal Canadian Army Cadet Dress Instructions

Figure 18 Straight Hair Worn Back in Bun

Braids. Shall be styled conservatively and tied tightly, secured at the end by a knot or a small-unadorned fastener. A single braid shall be worn in the centre of the back. Double braids shall be worn behind the shoulders. Hair shall be a maximum length, when gathered behind the head and braided, which does not extend below the top of the armpit.

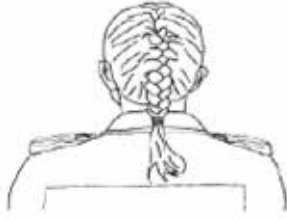

Royal Canadian Army Cadet Dress Instructions

Figure 19 One Braid



Royal Canadian Army Cadet Dress Instructions

Figure 20 Two Braids

Multiple braids and/or cornrows shall be directed to the back of the head, pulled tight to the head and secured at the end by a knot or a small-unadorned fastener. Multiple braids extending below the edge of the collar are to be gathered in a bun. Hairpieces and extensions are not permitted.



Royal Canadian Army Cadet Dress Instructions

Figure 21 Back View of Cornrows



Royal Canadian Army Cadet Dress Instructions

Figure 22 Side View of Cornrows



Royal Canadian Army Cadet Dress Instructions

Figure 23 Beret and Cornrows

MAKE-UP

Females are permitted to wear a minimal amount of make-up. When wearing the uniform, make-up shall be applied conservatively. There are to be no false eyelashes, heavy eyeliner, brightly coloured eye shadow or lipstick, coloured nail polish or excessive facial make-up.

JEWELLERY

The only jewellery that may be worn in uniform shall be a wristwatch (conservative in design and colour), a medical alert bracelet, and a maximum of two rings which are not of costume jewellery nature.

Female cadets in uniform may wear a single pair of plain gold, silver stud or white pearl earrings in pierced ears. The single stud earring, worn in the centre of each earlobe, shall be spherical in shape and not exceed 0.6 cm in diameter. Male cadets are not authorized to wear an earring or earrings.

Only a single earring or healing device, worn in the centre of each earlobe, may be worn at a time.



Royal Canadian Army Cadet Dress Instructions

Figure 24 Placement of Earrings

TATTOOS AND BODY PIERCING

Cadets shall not acquire visible tattoos that could be deemed as offensive or otherwise reflect discredit on the CCO. Cadets in uniform shall not wear visible body piercing adornments (tongue included). Use of an adhesive bandage for the purpose of covering a piercing is **not** authorized.

UNDERGARMENTS

Undergarments including brassieres for female cadets, shall be worn under all numbered orders of dress and shall be of an appropriate colour so as not to be visible through uniform items of clothing. Males shall also wear an undergarment under the highland order of dress.

EYEGASSES/SUNGLASSES

Eyeglasses and sunglasses shall be conservative in design and colour. Sunglasses with photo chromic or mirrored lenses are not authorized for wear.

Cadets who normally wear eyeglasses may wear either conventionally framed prescription sunglasses, or conservatively styled clip-on sunglasses when conditions and circumstances dictate. Other cadets may wear conservatively styled sunglasses, which do not detract from the overall appearance of the uniform when conditions and circumstances dictate. Sunglasses shall not be worn on parade day unless authorized by the cadet corps or CSTC CO in special circumstances.

OTHER

Civilian Clothing. Civilian clothing, other than those specific items listed in CATO 46-01 shall not be worn with the cadet uniform unless authorized by the cadet corps or CSTC CO in special circumstances. This includes but is not limited to civilian jackets and hats.

Backpacks. Civilian pattern backpacks of conservative appearance may either be carried in the left hand or worn suspended from both shoulders and square on the back. No item will be suspended from the backpack and straps and straps shall not be left loose.

Purse. (Female cadets only) The purse must be black and conservative in nature, and held in the left hand or suspended over the left forearm. When the purse is carried as a shoulder bag, the strap shall be suspended from the left shoulder with the top of the purse not higher than waist level. The purse shall not be carried as a shoulder bag with the strap shortened to handbag length.

Carrying of Articles. If any one article is carried, such as a briefcase, umbrella or raincoat, it shall be carried in the left hand. If an article is carried when marching, the left arm is not swung.



Chewing gum, slouching, sauntering, placing hands in pockets, smoking or eating on the street, walking hand in hand, and similar deportment which detracts from a proud and orderly appearance in the eyes of the public is unacceptable for cadets in uniform.

Teaching Point 6

Explain orders of dress.

Time: 10 min

Method: Interactive Lecture

Although there are many orders of dress for the Army Cadet uniform, cadets should be aware of the orders they will be asked to wear most often.

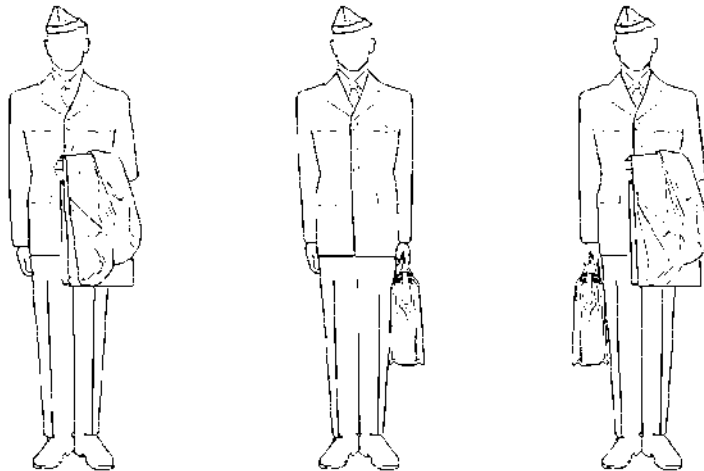

A-PD-201-000/PT-000, The Canadian Forces Manual of Drill and Ceremonial

Figure 25 The Carrying of Articles

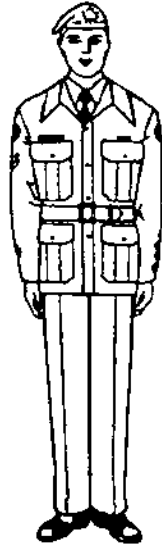

Royal Canadian Army Cadet Dress Instructions

Figure 26 C-2 Duty Dress

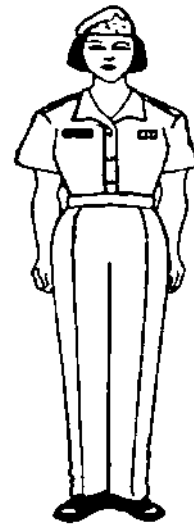

Royal Canadian Army Cadet Dress Instructions

Figure 27 C-2A Duty Dress

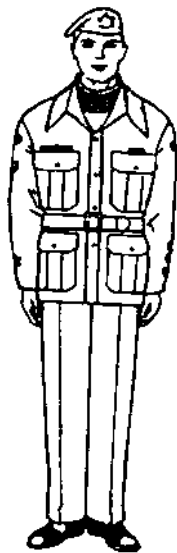

Royal Canadian Army Cadet Dress Instructions

Figure 28 C-3 Duty Dress



Royal Canadian Army Cadet Dress Instructions

Figure 29 PT



Instructors are responsible to explain other orders of dress that are worn by the cadet corps, as authorized by the CO of the affiliated unit. One method to do this is by introducing the class to various cadets dressed in the forms of dress to be illustrated. The cadet can then describe how the uniform is worn.

CONFIRMATION OF TEACHING POINT 5

QUESTIONS

- Q1. What are some things that cadets are not allowed to do with their hair?
- Q2. Are male cadets permitted to wear earrings?
- Q3. Cadets are not authorized to have tattoos that are what?

ANTICIPATED ANSWERS

- A1. Cadets are not to bleach their hair or dye it colours such as bright red, purple, green or orange.
- A2. No, male cadets are not permitted to wear an earring or earrings.
- A3. Offensive in nature or otherwise reflect discredit to CCO.

END OF LESSON CONFIRMATION

OPTIONAL ACTIVITY

Time: 10 min (If time permits)

OBJECTIVE

- The objective of the activity is to have the cadets properly identify various parts of the uniform and demonstrate the proper wearing and care of the piece.

RESOURCES

- Uniform pieces presented in lesson.
- Grocery bag or hat to put slips of paper in.
- Slips of paper with uniform pieces written on them (written out parts are found in Annex A).

ACTIVITY LAYOUT

- Cut out and place the pieces of paper with the uniform parts written on them in a grocery bag or hat.
- One at a time, each cadet will chose a slip of paper and find that part of the uniform.
- After finding the uniform part, the cadet will show the class how to properly wear and care for that piece.
- Repeat these steps until each cadet has chosen a piece. If there are more cadets than pieces of uniform, put the pieces back in the bag and start again.

SAFETY

- This shall be a supervised activity.

INSTRUCTOR GUIDELINES

- During the activity the instructor will supervise the cadets as they present each piece of the uniform and make corrections as required.

CONCLUSION

HOMEWORK/READING/PRACTICE

Nil.

METHOD OF EVALUATION

Nil.

CLOSING STATEMENT

The Army Cadet uniform should be worn properly at all times. The cadet uniform is highly recognizable and the standard of personal dress, appearance, and grooming shall be such as to reflect credit on the individual and on the CCO. The intent is to ensure a high standard of grooming consistent with that expected of cadets while both sensitive to the multicultural makeup of Canadian society.

INSTRUCTOR NOTES/REMARKS

This lesson should be scheduled to be conducted at the beginning of the training year.

REFERENCES

A0-002 A-PD-201-000/PT-000 DHH 3-2. (2001). *The Canadian Forces Manual of Drill and Ceremonial*. Ottawa, ON: National Defence.

A2-028 D Cds. (2005). CATO 46-01, *Army Cadet Dress Instructions*. In *Cadet Administrative and Training Orders* (Vol. 4, 27 pages). Ottawa, ON.

C2-039 Apparel Search. (2005). *Berets in the Military: Canada*. Retrieved 25 May 2006, from http://www.apparelsearch.com/definitions/headwear_hats/beret_definitions.htm.

THIS PAGE INTENTIONALLY LEFT BLANK

UNIFORM PIECES

Beret	Green Cotton T-shirt	Black Gloves and Mitts	Running Shoes
Cap Badge	Turtleneck Sweater	Name Tag	Grey Wool Socks
Wide-brimmed Tan Summer Hat	Jacket and Jacket Belt	Trousers	Corps Shoulder Badge
Toque	All-season Jacket	Black Belt	Pte Rank Badge
Short Sleeve Shirt	Rank Slip-ons	Grey Sports Shorts	
Necktie	Grey Sports T-shirt	Boots	

THIS PAGE INTENTIONALLY LEFT BLANK



ROYAL CANADIAN ARMY CADETS
GREEN STAR
INSTRUCTIONAL GUIDE



SECTION 6

EO M107.06 - PARTICIPATE IN A DISCUSSION ON YEAR ONE SUMMER TRAINING OPPORTUNITIES

Total Time: 30 min

PREPARATION

PRE-LESSON INSTRUCTIONS

Resources needed for the delivery of this lesson are listed in the lesson specification located in A-CR-CCP-701/PG-001, *Green Star Qualification Standard and Plan*, Chapter 4. Specific uses for said resources are identified throughout the instructional guide within the TP for which they are required.

Review the lesson content and become familiar with the material prior to delivering the lesson.

Review CATO 40-01 for familiarization with Army Cadet Summer Training Center opportunities available to Cadets.

PRE-LESSON ASSIGNMENT

Nil.

APPROACH

An interactive lecture was chosen for this lesson to orient the cadets to CSTC opportunities.

INTRODUCTION

REVIEW

Nil.

OBJECTIVES

By the end of the lesson the cadets shall be expected to be familiar with the opportunities available to them for summer training in year one, and shall be introduced to the various summer training streams of the army cadet program.

IMPORTANCE

It is important for the cadets to understand the training opportunities available to them during the summer so they are aware of what courses they are eligible to attend in order to plan their progression effectively.

Teaching Point 1**Discuss the General Training course.**

Time: 15 min

Method: Interactive Lecture

AIM

The aim of the General Training qualification is to introduce Army Cadets to the Cadet Summer Training Centre environment and specialty training qualifications.

LOCATIONS

Figure 1 Map of Summer Training Centres Across Canada

The General Training qualification, which is two weeks in duration, is conducted at five cadet summer training centres (CSTC) throughout Canada. Cadets will most likely travel to the CSTC within their region, unless there are extenuating circumstances. The General Training qualification is conducted at:

- CSTC Argonaut, Gagetown, New Brunswick – Atlantic Region;
- CSTC Blackdown, Borden, Ontario – Central Region;
- Centre d’Instruction d’Été des Cadets (CIEC) Valcartier, Quebec – Eastern Region;
- CSTC Vernon, British Columbia – Prairie and Pacific Region; and
- CSTC Whitehorse, Yukon – Northern Region.



Emphasize the location of the CSTC the cadet would attend. Photos and additional information should be presented as available.

REQUIREMENTS OF THE COURSE

Cadets must participate in certain performance requirements during the General Training qualification. These requirements include:

- introduction to specialties: expedition, marksmanship, music, drill and ceremonial, fitness and sports,
- introduction to community living,
- biathlon,
- adventure training,
- leadership,
- development of self-discipline, and
- CF familiarization.

ADDITIONAL TRAINING OPPORTUNITIES PROVIDED DURING THE COURSE

General Training offers additional opportunities which are common to all CSTC Program courses, such as:

- weekly parades,
- life skills,
- recreation sports,
- swimming, and
- a graduation parade.

CONFIRMATION OF TEACHING POINT 1

Q1. How long is General Training?

Q2. Where is the CSTC that you will be attending?

Q3. What are examples of activities that are common to all cadet CSTC Program courses?

ANTICIPATED ANSWERS:

A1. General Training is two weeks in duration.

A2. Answers will vary based on region.

- CSTC Argonaut, Gagetown, New Brunswick – Atlantic Region;
- CSTC Blackdown, Borden, Ontario – Central Region;
- Centre d’Instruction d’Été des Cadets (CIEC) Valcartier, Quebec – Eastern Region;
- CSTC Vernon, British Columbia – Prairie and Pacific Region; and
- CSTC Whitehorse, Yukon – Northern Region.

A3. Any of the following: weekly parades; life skills; recreation sports; swimming; and a graduation parade.

Teaching Point 2**Describe the summer training series of courses.**

Time: 10 min

Method: Interactive Lecture

SUMMER TRAINING SERIES OF COURSES

Summer training can be looked at as choosing a path. Though cadets are not limited to staying on one path of training, it is an option that allows them to progress in an area of their interest.

All Green Star cadets will complete General Training before moving into the various specialist series of courses. The various series of courses available to cadets are:

Ceremonial Leadership Series Qualifications, to include:

- Basic Leadership, and
- Drill and Ceremonial Instructor;

Expedition Leadership Series Qualifications, to include:

- Basic Expedition,
- Expedition Instructor,
- Leadership and Challenge, and
- Army Cadet Senior Expeditions (Outward Bound Wales, Outward Bound Scotland, Maple Leaf);

Fullbore Marksman Series Qualifications, to include:

- Basic Marksman,
- Fullbore Marksman Phase I,
- Fullbore Marksman Phase II, and
- National Army Cadet Rifle Team;

Air Rifle Leadership Series Qualification, to include: Air Rifle Marksmanship Instructor;

Fitness And Sports Leadership Series Qualifications, to include:

- Basic Fitness and Sports, and
- Fitness and Sports Instructor;

Military Band Series Qualifications; to include:

- Military Band - Basic Musician,
- Military Band - Intermediate Musician, and
- Military Band - Advanced Musician;

Pipe Band Series Qualifications; to include:

- Pipe Band - Basic Musician,
- Pipe Band - Intermediate Musician, and
- Pipe Band - Advanced Musician;

Other Qualifications And Exchanges; to include:

- Basic Parachutist (Year 5/6), and
- Army Cadet Exchanges (Year 5/6) – Maple Leaf England, Outward Bound Scotland, Outward Bound Wales. Other ACE locations vary, and

Advanced training Opportunities – Staff Cadet (Year 4+).

CONFIRMATION OF TEACHING POINT 2

QUESTIONS:

- Q1. What are two of the series of summer training courses a cadet can choose?
- Q2. Can cadets apply to a CSTC Program course that is outside of their current series of courses?
- Q3. If cadets join the program when they are older, do they still have to attend the General Training Course in their first summer at camp?

ANTICIPATED ANSWERS:

- A1. Any of the following:
- Ceremonial Leadership,
 - Expedition Leadership,
 - Fullbore Marksman,
 - Air Rifle Leadership,
 - Fitness and Sports Leadership,
 - Military Band, or
 - Pipe Band.
- A2. Yes.
- A3. No, they can apply for a year two or possibly a year three course.

END OF LESSON CONFIRMATION

Instructors may ask the following questions:

QUESTIONS:

- Q1. How long is General Training?
- Q2. What are two of the series of summer training courses a cadet can choose?

ANTICIPATED ANSWERS

- A1. General Training is two weeks in duration.
- A2. Any of the following:
- Ceremonial Leadership,
 - Expedition Leadership,

- Fullbore Marksman,
- Air Rifle Leadership,
- Fitness and Sports Leadership,
- Military Band, and
- Pipe Band.

CONCLUSION

HOMEWORK/READING/PRACTICE

Nil.

METHOD OF EVALUATION

Nil.

CLOSING STATEMENT

Many cadets will have the opportunity to attend summer training centres after completing the green star program at the corps. It is important for them to know what options are available to them for their first summer. It is also important for them to gain a basic understanding of opportunities available to them in the future.

INSTRUCTOR NOTES/REMARKS

Nil.

REFERENCES

A2-031 CATO 40-01 Director Cadets (2011). *Army cadet program outline*. Ottawa, ON: Department of National Defence.

A2-077 A-CR-CCP-711/PG-001 Director Cadets 3. (2007). *Royal Canadian Army Cadets, General Training, Qualification standard and plan*. Ottawa ON: Department of National Defence.



ROYAL CANADIAN ARMY CADETS
GREEN STAR
INSTRUCTIONAL GUIDE



SECTION 7

EO C107.01 – MAINTAIN THE ARMY CADET UNIFORM

Total Time:

90 min

PREPARATION

PRE-LESSON INSTRUCTIONS

Resources needed for the delivery of this lesson are listed in the lesson specification located in A-CR-CCP-701/PG-001, *Green Star Qualification Standard and Plan*, Chapter 4. Specific uses for said resources are identified throughout the instructional guide within the TP for which they are required.

Review the lesson content and become familiar with the material prior to delivering the lesson.

PRE-LESSON ASSIGNMENT

Prior to the lesson the cadet shall gather all uniform parts to bring with them for this lesson.

APPROACH

An interactive lecture was chosen for TP 1 to orient the cadets to the tips for ironing the uniform.

The demonstration and performance was chosen for TPs 2 –8 as it allows the instructor to explain and demonstrate the care of the uniform while providing an opportunity for the cadets to practice under supervision.

INTRODUCTION

REVIEW

The pertinent review for this lesson, from EO M107.05 (Section 5), will include:

QUESTIONS

- Q1. Do cadets have to wear their uniform when proceeding to and from a CSTC?
- Q2. Over which eye is the beret centred?
- Q3. The nametag is centred over which breast pocket?

ANTICIPATED ANSWERS

- A1. Yes.
- A2. The left eye.
- A3. The right pocket.

OBJECTIVES

By the end of this lesson the cadet shall be expected to properly maintain the Army Cadet uniform.

IMPORTANCE

The cadet uniform is highly recognizable and the standard of personal dress, appearance and grooming shall be such to reflect credit on the individual and the Canadian Cadet Organization (CCO).

Teaching Point 1**Identify tips for ironing the uniform.**

Time: 5 min

Method: Interactive Lecture

TIPS FOR IRONING THE UNIFORM

There are several points to keep in mind when ironing the uniform:

- Before plugging in the iron, ensure the surface is clean.
- Check the temperature of the iron so that it is not so hot that it may burn the material.
- Ensure the article of the uniform is clean.
- Have a spray bottle of water or can of spray starch handy for creases.
- A damp pressing cloth could be used to prevent parts of the uniform from burning or becoming shiny. Some examples of what can be used as a pressing cloth include:
 - thin towel;
 - pillow case;
 - soft cotton cloth; or
 - paper bag.



Extreme care must be taken when using an iron.

CONFIRMATION OF TEACHING POINT 1

QUESTIONS

- Q1. What is the purpose of using a pressing cloth?
- Q2. What are some items that can be used as a pressing cloth?
- Q3. What should you do before plugging in the iron?

ANTICIPATED ANSWERS

- A1. To prevent uniform parts from becoming shiny.
- A2. Thin towel, pillow case, soft cotton cloth and paper bag.
- A3. Ensure the surface is clean.

Teaching Point 2**Demonstrate the correct method of care for the trousers.**

Time: 10 min

Method: Demonstration

TROUSERS

The trousers/slacks shall must be clean and free from lint at all times. The trousers will present well pressed creases down the centre of each leg in the front and the back. Creases shall extend from the top of the leg to the bottom. A well pressed trouser can be achieved by:

- lining the pant leg up by the seams to ensure the creases are properly positioned at the centre of the front and back leg;
- laying the pant leg flat on the ironing board;
- spraying the pants with water from a water bottle;
- placing a pressing cloth over the pant leg;
- ironing the pants until a sharp crease extends down the centre of each leg in the front and back, from the top of the leg to the bottom; and
- ironing on the same crease each time in order to avoid double creases.

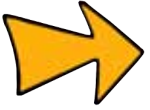

The length of the trousers should extend to the third eyelet of the ankle boot.

Teaching Point 3**Demonstrate the correct method to care for the short sleeve shirt.**

Time: 10 min

Method: Demonstration

SHORT SLEEVE SHIRT

The linden green short sleeve shirt shall be clean and pressed in that:

- the sleeves shall have creases down the centre of the sleeve, centred on the epaulette of the shirt, to the bottom;
- the front and back panels shall be pressed flat without creases;
- the collar shall be pressed flat; and
- the entire shirt shall be free from wrinkles.

Teaching Point 4**Demonstrate the correct method for care of the tunic.**

Time: 5 min

Method: Demonstration

TUNIC

The tunic shall be clean and pressed in that:

- the sleeves shall be pressed flat with no creases;
- the front panels and the pockets shall be pressed flat;

- the back panel shall be pressed flat without creases; and
- the collar shall be pressed flat.

Teaching Point 5**Demonstrate general guidelines for maintaining the boots.**

Time: 5 min

Method: Demonstration

BOOTS

The entire boot, to include the sides, heel and toe shall be polished using black shoe polish and a soft polishing cloth. The tongue, welts and outer edge of the sole shall be blackened. Boots shall not be modified with any type of metal cleats, hobnails or other metal attachments to heel or sole, and shall be laced across horizontally from side to side in accordance with Figure 1.



Cadets shall not, while polishing:

- apply any heat source to the boot e.g. “burn shine”,
- melt polish,
- use floor polish,
- use oxblood coloured polish, or
- use liquid polish.



CATO 46-01 Army Cadet Dress Instructions

Figure 1 Boot Lacing

Teaching Point 6**Demonstrate the correct method of care for the beret.**

Time: 6 min

Method: Demonstration

BERET WASHING

To clean and care for the beret:

- it is washed with mild detergent in cold water, wringing out excess water; and
- remove lint with a lint brush.

BERET FORMING

The beret, while damp, shall be formed in that:

- the beret is correctly positioned on the head as per CATO 46-01;
- the crown is pulled from the left down the right side and to the rear;
- the edge of the right side shall not cover the ear; and
- it is left to air dry as formed.



Never put your beret into a clothes dryer. Because it is made of wool, the beret will shrink.



Cadets may be required to attach the brass/cloth cap badge to the beret. When attaching a cap brass to a new beret, a small slit - not to exceed the width of the backing post – shall be cut into the fabric of the beret, centred on the cardboard backing. In the event that a cadet is required to perform such a procedure, the instructor shall demonstrate the proper method for attaching the brass. Cloth cap badges will be affixed to the beret, centred on the cardboard backing, and sewn on with thread that will blend with the badge.

CONFIRMATION OF TEACHING POINT 6

QUESTIONS

- Q1. What temperature water is used to wash a beret?
- Q2. How is a beret to be dried?
- Q3. Demonstrate the proper method for forming the beret.

ANTICIPATED ANSWERS

- A1. Cold water.
- A2. Air dried.
- A3. The instructor shall observe the demonstration noting if:
- the beret is correctly positioned on the head as per CATO 46-01;
 - the crown is pulled from the left down the right side and to the rear; and
 - the edge of the right side shall not cover the ear.

Teaching Point 7

Demonstrate the correct method for wearing the hair.

Time: 10 min

Method: Demonstration

HAIR

Hair on the head shall be neatly groomed and conservatively styled. The length, bulk and style of hair shall not preclude the proper wear of the beret (bulk is the distance that the mass of hair extends from the skin, when groomed, as opposed to the length of hair). Style and colour shall not be bizarre, bleached, exaggerated or

unusual in appearance. Unusual colours such as green, bright red, orange, purple, etc. are not permitted. Hair must be secured or styled back to reveal the face and any accessories used to secure or control hairstyles shall be as unobtrusive as possible. Hair ornaments shall not be worn, except for female cadet's conservative barrettes, which blend with the hair colour.

MALE HAIR

- Hair is to be taper trimmed at the back, sides, and above the ears to blend with the hairstyle; be no more than 15 cm (6 in.) in length and sufficiently short that, when the hair is groomed and beret is removed, no hair shall touch the ears or fall below the top of the eyebrows; be no more than 4 cm (1-1/2 in.) in bulk at the top of the head, gradually decreasing to blend with the taper trimmed sides and back; and be kept free from the neck to a distance of 2.5 cm (1 in.) above the shirt collar. Taper trimmed square back styles and shaving of all the hair on the head are permitted.
- Sideburns shall not extend below a line horizontally bisecting the ear, and shall be squared off horizontally at the bottom edge and taper trimmed to conform to the overall hairstyle.
- When moustaches are worn alone, the unshaven portion of the face shall not extend outwards beyond the corners of the mouth. Moustaches shall be kept neatly trimmed; not be greater than 2 cm (3/4 in.) in bulk; not extend below the corners of the mouth and not protrude beyond the width of the mouth.
- Beards shall not be worn except for those cadets who are adherents of the Sikh religion or cadets experiencing recognized medical problems preventing them from shaving. In the latter case, a note from a medical practitioner is required.

The following additional details apply to female cadets:

- hair shall not extend below the lower edge of the shirt collar (see exception below);
- exaggerated styles, including those with excessive fullness or extreme height, are not authorized;
- braids, if worn, shall be styled conservatively and tied tightly, secured at the end by a knot or a small-unadorned fastener;
- a single braid shall be worn in the centre of the back;
- double braids shall be worn behind the shoulders;
- hair shall be a maximum length when gathered behind the head and braided which does not extend below the top of the armpit; and
- multiple braids and/or cornrows shall be directed toward the back of the head, pulled tight to the head and secured at the end by a knot or a small unadorned fastener. Multiple braids extending below the lower edge of the collar are to be gathered in a bun.



Exception. With the permission of the corps CO, a 60-day transition period may be granted to a female cadet to grow her hair longer for re-styling, during which time hair may extend below the lower edge of the shirt collar. Hairpieces and extensions are not permitted.

Teaching Point 8

Supervise and advise cadets as they practice maintaining the uniform.

Time: 30 min

Method: Performance

ACTIVITY

Time: 30 min

OBJECTIVE

The objective of this activity is to have the cadets demonstrate care and maintenance of the Army Cadet uniform.

RESOURCES

- Uniform pieces presented in the lesson.
- Irons.
- Ironing boards/tables.
- Pressing cloths.
- Water bottle.
- Black boot polish.
- Soft boot cloth.
- Old toothbrush.
- Hair elastics.
- Hair nets.
- Bobby pins.
- Hair spray.
- Scissors.
- Assistants if available.

ACTIVITY LAYOUT

- Divide class into five groups.
- Groups will be assigned a station to start at:
 - Station 1: Maintain the trousers;
 - Station 2: Maintain the short sleeve shirt;
 - Station 3: Maintain the jacket;
 - Station 4: Maintain the boots; and
 - Station 5: Correct wear of the hair.

- Each group will rotate through each of the stations for a specified amount of time, approximately five minutes at each.
- The cadets are to maintain the parts of the uniform at each station, with the assistance of senior cadets or officers, if they are available.

SAFETY

Cadets must be carefully supervised while using hot irons.

INSTRUCTOR GUIDELINES

- During the activity supervise and praise the cadets as they maintain each part of the uniform.
- Assistant instructors should be made available to help supervise at the stations.
- If only the instructor is available they are to rotate around the stations to supervise all cadets.
- Signal timings for station rotations.
- If cadets do not have uniform parts, ensure extra parts are available for the cadets to use.

END OF LESSON CONFIRMATION

The end of lesson confirmation consists of the instructor inspecting the cadets' uniforms to ensure they meet the standards that have been outlined.

CONCLUSION

HOMEWORK/READING/PRACTICE

Nil.

METHOD OF EVALUATION

Nil.

CLOSING STATEMENT

The Army Cadet uniform should be worn properly at all times. The cadet uniform is highly recognizable and the standard of personal dress, appearance and grooming shall be such as to reflect credit on the individual and on the CCO. The intent is to ensure a high standard of grooming consistent with that expected of cadets.

INSTRUCTOR NOTES/REMARKS

It is recommended to have an assistant instructor for this lesson.

In suitable quantities, the instructor is expected to locally acquire some of the resources to enhance this period, to include:

- ironing board,
- iron,
- starch,
- black boot polish,
- soft boot cloth,
- toothbrush for boot welts,

- scissors,
- lint brush,
- hair elastics,
- bobbi pins, and
- hair net.

REFERENCES

A0-001 A-AD-265-000/AG-001 DHH 3-2. (2001). *Canadian Forces Dress Instructions*. Ottawa, ON: National Defence.

A2-028 D Cdts. (2005). CATO 46-01, *Army Cadet Dress Instructions*. In *Cadet Administrative and Training Orders* (Vol. 4, 27 pages). Ottawa, ON.



**COMMON TRAINING
GREEN STAR
INSTRUCTIONAL GUIDE**



SECTION 8

EO C107.02 – PARTICIPATE IN A TOUR OF THE CADET CORPS

Total Time:

30 min

PREPARATION

PRE-LESSON INSTRUCTIONS

Resources needed for the delivery of this lesson are listed in the lesson specification located in A-CR-CCP-701/PG-001, *Green Star Qualification Standard and Plan*, Chapter 4. Specific uses for said resources are identified throughout the instructional guide within the TP for which they are required.

Review the lesson content and become familiar with the material prior to delivering the lesson.

Coordinate tour with all corps departments. Review zone protocols for offices, parades square, classrooms, break areas, out of bound areas and saluting zones.

Brief assistant instructors. Arrange for one assistant instructor per group of four cadets.

Prepare corps passports.

Prepare maps of the corps facilities with numbered points of interest.

Set up sticker stations at each point of interest.

PRE-LESSON ASSIGNMENT

Nil.

APPROACH

A practical activity was chosen for this lesson as it is an interactive way for cadets to learn about the facilities of their cadet corps in a safe and controlled environment.

INTRODUCTION

REVIEW

The pertinent review for this lesson will include:

- officer ranks (TP2 of EO M107.02 [Section 2]); and
- regulations for paying compliments inside a building (TP3 of EO M107.03 [Section 3]).

OBJECTIVES

By the end of this lesson the cadet shall be expected to:

- identify the location of:
 - the parade square;
 - classrooms;
 - break areas;
 - canteen;
 - washrooms;
 - communication areas;
 - Commanding Officer's (CO's) office;
 - administration office;
 - training office;
 - supply office; and
 - out of bounds areas; and
- observe appropriate protocols associated with each location.

IMPORTANCE

Being familiar with the location of all the corps facilities can aid the cadets in following instructions, finding information and participating in corps activities.

Teaching Point 1**Participate in a tour of the cadet corps.**

Time: 30 min

Method: Practical Activity

BACKGROUND KNOWLEDGE

This information is representative only. Information presented must be tailored to be specific to the corps. Individual corps may have information that will vary from the information given in this guide.

PARADE SQUARE

The parade square is where cadets have parades. It is where inspections and drill classes usually take place and where the corps holds parades and other ceremonial events. Appropriate corps protocols should be followed regarding the parade square.

CLASSROOMS

Classrooms are the areas where cadets participate in most of their training. The classroom space must be respected, especially in facilities that are shared with other groups. Anything that does not belong to the corps should be left alone. Protocol for entering and leaving the classroom should be followed.

BREAK AREAS

Break areas are where the cadets should be when not tasked. The corps guidelines for the use of the area should be discussed.

CANTEEN

The canteen is a store for snacks and other items. The money raised through the canteen may be used to benefit the corps. Hours of operation, personnel responsible and how the money is used should be discussed.

WASHROOMS

The location of the facilities should be pointed out.

COMMUNICATIONS AREAS

Communications areas could include bulletin boards, activity sign-up sheets, and the location of the standing orders and routine orders. The standing orders contain corps policies. The routine orders contain information on duties, events, activities and personnel changes. Authorization to post information should be discussed.

COMMANDING OFFICER'S OFFICE

If the CO is available, they should introduce themselves and state briefly what they do. If the CO is not available, the tour guide will provide this information. The CO is at the top of the chain of command within the corps. The CO is responsible for the training and administration of the cadets, civilian instructors and officers working with the corps. Cadets will normally only visit the CO's office at the CO's request, or if directed by another officer. Protocol for entering and leaving an office should be reviewed.

ADMINISTRATION OFFICE

If the administration staff is available, they should introduce themselves and state very briefly what they do. If they are not available, the tour guide will provide this information. The Administration Officer (Admin O) is responsible for handling the administrative duties. They are responsible for ensuring forms such as cadet enrolments and summer training applications are completed in full and returned in a timely fashion. They could also be responsible for ensuring attendance is taken for all corps activities. Other administrative staff may include assistant administration officers. Cadets may need to go to the administration office to complete paperwork, report absences or to pick up forms. Protocol for entering and leaving an office should be reviewed.

TRAINING OFFICE

If the training staff is available, they should introduce themselves and state very briefly what they do. If they are not available, the tour guide will provide this information. The Training Officer (Trg O) is responsible for the coordination and implementation of the corps training program. They are responsible to ensure that training is planned in a logical fashion, instructors are prepared for classes and training materials are readily available for classes. They are also responsible for any administrative forms that are directly related to training, such as training records. Other training staff could include an assistant Trg O, standards officer and level Trg Os. Cadets will normally only visit the training office if the training officer has requested them, or they have been directed by another staff member or cadet NCO. Protocol for entering and leaving an office should be reviewed if applicable.

SUPPLY OFFICE

If the supply staff is available, they should introduce themselves and state very briefly what they do. If they are not available, the tour guide will provide this information. The Supply Officer (Sup O) is responsible for ordering uniform parts, issuing uniforms parts as necessary and distributing other equipment. They are responsible for all administrative forms that are directly related to supply. Other supply staff could include assistant Sup Os. Cadets will normally visit the supply office to receive their uniform and to exchange items that no longer fit or have become damaged. Appointments may be necessary. If the supply section has specific hours when it is open to cadets, these hours should be stated. Protocol for entering and leaving an office should be reviewed, if applicable.

OUT OF BOUNDS AREAS

Any areas that are out of bounds to cadets should be pointed out. The consequences for violating this policy should be explained.

ACTIVITY

Time: 20 min

OBJECTIVE

This activity is designed to familiarize the cadet with the facilities and staff of their corps.

RESOURCES

- Corps maps with numbered points of interest, if available (an example map is provided in Annex A).
- Corps passports.
- Stickers.

ACTIVITY LAYOUT

1. Divide the cadets into groups of four and assign each group a tour guide. Each cadet will receive a passport, found in Annex B, to be completed during the tour.



Group size may be adjusted based on the number of available tour guides and the number of cadets in the class.

2. Give each group a map and assign a starting point of interest. Starting points should be separated by one point if possible, to avoid more than one group at any one point during the tour.
3. Each group shall progress through the tour by visiting the points of interest. Tour guides will present the appropriate information at each point. Only one to two minutes should be necessary at each stop.
4. Each cadet shall answer the questions for each point of interest on their corps passports. The tour guide will check the answers at each point and award stickers to complete the passport.

SAFETY

Nil.

INSTRUCTOR GUIDELINES

- Brief the tour guides on activity layout and their role.
- Circulate throughout the corps facilities to watch for bottlenecks and move groups along as necessary.
- Answer questions.
- Ensure protocols are being observed.

REFLECTION

Time: 5 min

Method: Group Discussion

GROUP DISCUSSION



Instructors shall ensure that all lesson objectives are drawn out towards the end of the reflection stage.

DISCUSSION QUESTIONS



TIPS FOR ANSWERING/FACILITATING DISCUSSION

- Ask questions that help facilitate discussion; in other words, avoid questions with yes or no answers.
- Prepare questions ahead of time.
- Be flexible (you are not bound to only the prepared questions).
- Encourage cadets to participate by using praise such as “great idea” or “excellent response, can anyone add to that?”.
- Try to involve everyone by directing questions to non-participants.

SUGGESTED QUESTIONS

Q1. Why is it important to know where all of the corps facilities are located?

Q2. How do you feel now that you know where everything is located?

Q3. What other information about the corps facilities would help you feel more comfortable at cadets?

CONCLUSION

HOMEWORK/READING/PRACTICE

Nil.

METHOD OF EVALUATION

Nil.

CLOSING STATEMENT

Knowing the location of all the corps facilities will assist cadets in following instructions, finding information and participating effectively in corps activities.

INSTRUCTOR NOTES/REMARKS

Nil.

REFERENCES

Nil.

EXAMPLE MAP

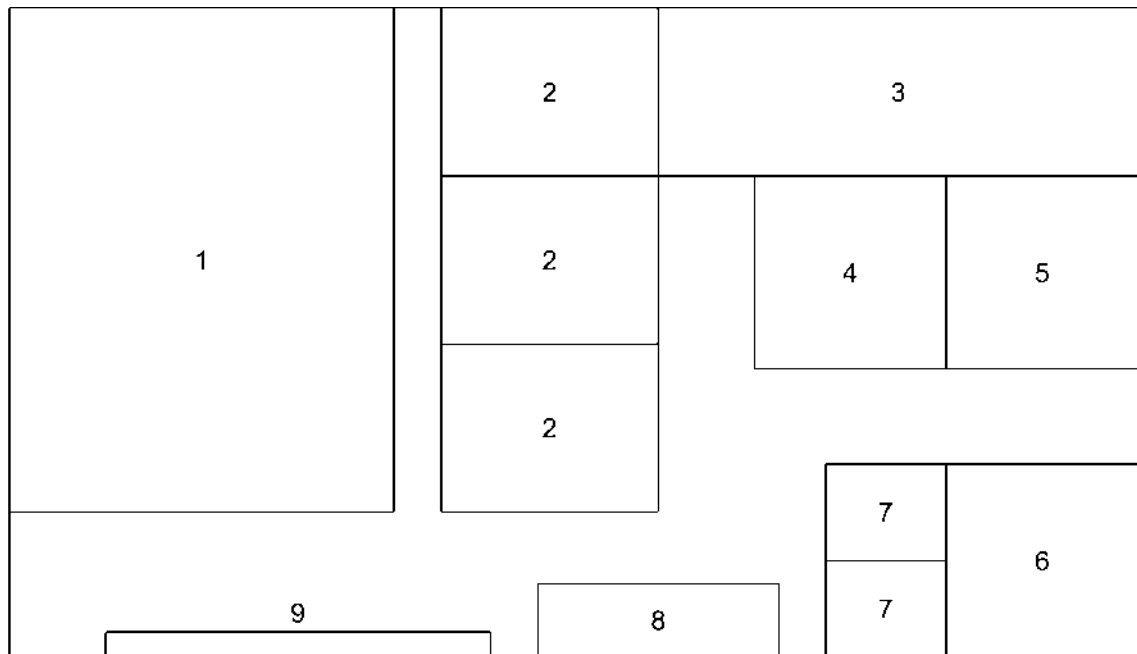

POINTS OF INTEREST:

1. Parade Square
2. Classrooms
3. Supply Office/Stores
4. Administration Office
5. Training Office
6. Commanding Officer's Office
7. Washrooms
8. Canteen
9. Communications Area

THIS PAGE INTENTIONALLY LEFT BLANK

CORPS PASSPORT

<p>THE PARADE SQUARE</p> <p>What are the rules for the parade square?</p> <p><i>Sticker</i></p>	<p>CLASSROOMS</p> <p>What rooms are used for classroom training?</p> <p><i>Sticker</i></p>
<p>BREAK AREAS</p> <p>Where is the break area?</p> <p><i>Sticker</i></p>	<p>CANTEEN</p> <p>When is the canteen available?</p> <p><i>Sticker</i></p>
<p>WASHROOMS</p> <p>Where are the washrooms located?</p> <p><i>Sticker</i></p>	<p>COMMUNICATION AREAS</p> <p>Where do cadets sign up for activities?</p> <p>Who is allowed to post information?</p> <p><i>Sticker</i></p>

<p>COMMANDING OFFICER'S OFFICE</p> <p>What is the <i>Commanding Officer's</i> name?</p> <p><i>Sticker</i></p>	<p>ADMINISTRATION OFFICE</p> <p>What is the <i>Administration Officer's</i> name?</p> <p>Who else works in Administration?</p> <p><i>Sticker</i></p>
<p>TRAINING OFFICE</p> <p>What is the <i>Training Officer's</i> name?</p> <p>Who else works in Training?</p> <p><i>Sticker</i></p>	<p>SUPPLY OFFICE</p> <p>What is the <i>Supply Officer's</i> name?</p> <p>Who else works in Supply?</p> <p><i>Sticker</i></p>
<p>OUT OF BOUNDS AREAS</p> <p>Which areas are out of bounds to cadets?</p> <p><i>Sticker</i></p>	



**COMMON TRAINING
GREEN STAR
INSTRUCTIONAL GUIDE**



SECTION 9

EO C107.03 – PARTICIPATE IN AN ACTIVITY ON THE HISTORY OF THE CADET CORPS

Total Time:

60 min

PREPARATION

PRE-LESSON INSTRUCTIONS

Resources needed for the delivery of this lesson are listed in the lesson specification located in A-CR-CCP-701/PG-001, *Green Star Qualification Standard and Plan*, Chapter 4. Specific uses for said resources are identified throughout the instructional guide within the TP for which they are required.

Review the lesson content and become familiar with the material prior to delivering the lesson.

PRE-LESSON ASSIGNMENT

Nil.

APPROACH

An in-class activity was chosen for TP 1 as it is an interactive way to provoke thought and stimulate interest among cadets about the history of their cadet corps.

A group discussion was chosen for TP 2 as it allows the cadets to interact with their peers and share their knowledge, experiences, opinions, and feelings about the history of their cadet corps.

INTRODUCTION

REVIEW

Nil.

OBJECTIVES

By the end of this lesson the cadet shall be expected to be familiar with:

- the formation of their corps;
- significant corps developments since inception; and
- awards and accomplishments of the corps.

IMPORTANCE

The history of a corps is a source of pride for those within it. Understanding the history of the corps allows the cadet to see what has shaped the unit since its inception and recognize the progress it has made in numerous areas.

Teaching Point 1**Conduct an activity on the history of the Cadet Corps.**

Time: 40 min

Method: In-Class Activity

BACKGROUND KNOWLEDGE

CORPS FORMATION

There are a number of events that are historically important during the creation of a corps. These include:

- the charter date for the corps;
- the initial composition of the corps, staff and cadets; and
- the first sponsor of the corps.

CORPS DEVELOPMENTS

Corps participate in a number of community service events. Some events may happen annually, while others may occur only during special occasions. These events include, but are not limited to:

- ceremonial parades;
- fundraising events for charities; and
- civic events.

Also, corps personnel are involved in a number of activities within their unit, which are an important part of the unit's history. These activities may include, but are not limited to:

- formation of various activities within the corps (such as a drill team, band, first aid team, marksmanship team, etc.);
- participation in exchanges; and
- corps trips to various locations.

Other important developments in the history of a corps include:

- the development of a corps crest; and
- the affiliation of a corps with a Canadian Forces (CF) military unit.

CORPS AWARDS AND ACCOMPLISHMENTS

There are a number of ways that a corps can be recognized. The recognition may come from winning a competition, or for demonstrating excellence in a particular area. These awards can be won on provincial, regional, national, and in some circumstances, international levels.

Many opportunities exist for cadets to win awards at all levels of the Canadian Cadet Organization (CCO). Cadets winning such awards reflect well upon the corps.

Memorial awards are awards that are left in memory of someone that has made significant contributions to the local corps or the CCO. Memorial awards that may be given are an important source of historical information within the corps.

Outside of awards, there are a number of other cadet accomplishments that make up a fundamental part of the corps history. They include, but are not limited to:

- civilian careers of former cadets; and
- military careers of former cadets.

ACTIVITY

Time: 40 min

OBJECTIVE

The objective of this activity is to familiarize the cadets with the history of their corps.

RESOURCES

- Corps photographs.
- Corps video.
- Corps awards.
- Flipchart paper.
- Flipchart markers.
- Construction paper.
- Three tables.
- Bristol board.

ACTIVITY LAYOUT

Before the activity:

- Prepare learning stations based on three topic areas:
 - corps formation;
 - corps developments; and
 - corps accomplishments.
- Identify each station by a colour.
- Ensure each learning station is dynamic by using photos, newspaper clippings, video clips; timelines, memorabilia, summaries on Bristol board or other items.
- Prepare four cadet research cards for each learning station.
- Each research card will be a different colour to correspond to the learning station of the same colour.
- These cards will have a key word written on them to indicate what the cadet is to research.

During the activity, the cadets will be:

- divided into groups of four with a maximum of six groups. If there are more than 16 cadets, make the groups larger. There can be more than one group at a learning station at a time;
- given several research cards that correspond to each of the three learning stations;

- given eight minutes to research information; and
- given seven minutes to prepare their researched information on flipchart paper.

SAFETY

Nil.

INSTRUCTOR GUIDELINES

During the activity the instructor shall ensure the cadets are collecting their information, and moving between learning stations in a timely manner.

Teaching Point 2

Conduct a group discussion about the activity.

Time: 10 min

Method: Group Discussion

REFLECTION

Time: 10 min

Method: Group Discussion

GROUP DISCUSSION



Once the activity is completed, the instructor shall have the groups come up to present their information to the class. The instructor shall call up groups with respect to the topic order listed in background information. The instructor should ensure they highlight any missed information after each topic has been presented.

DISCUSSION QUESTIONS



- During this stage the instructor should quickly pose some questions to the class to confirm their understanding of the knowledge presented in the lesson.
- Some of the questions below may not have been directly answered through the learning station. It is the responsibility of the instructor to create a brief discussion around these questions, emphasizing important points brought forth by the cadets.

SUGGESTED QUESTIONS

- Q1. Why is it important for members of the corps to be familiar with how it was formed?
- Q2. Why are memorial awards important to the history of a corps?
- Q3. Why is it important for cadets to understand the history of the corps' involvement within their community?
- Q4. What role do activities such as drill team, band, first aid, etc. play in developing a corps?

CONCLUSION

REVIEW

Upon completion of the group discussion the instructor will conclude by summarizing to ensure that all teaching points have been covered. The instructor must also take this opportunity to explain how the cadet will apply this knowledge in the future.

MAIN TEACHING POINTS

TP1. Discuss the formation of the corps.

TP2. Discuss significant corps developments since its inception.

TP3. Discuss awards and accomplishments of the corps.

HOMEWORK/READING/PRACTICE

Nil.

METHOD OF EVALUATION

Nil.

CLOSING STATEMENT

Being familiar with the history of the corps will give cadets a reason to take pride in being a part of it. Having a good understanding of this information can give cadets more of an appreciation of the corps and allow them to pass this information on to others.

INSTRUCTOR NOTES/REMARKS

Information used by the instructor for the learning stations will depend on materials available at each unit.

REFERENCES

Nil.

MEMORIAL AWARDS

(Green Construction Paper)

Corps/Squadron Formation

CHARTER

(Red Construction Paper)

Corps/Squadron Developments

HEART AND STROKE FOUNDATION CAMPAIGN

(Blue Construction Paper)

Corps/Squadron Accomplishments

LCOLSHEA CITIZENSHIP AWARD

THIS PAGE INTENTIONALLY LEFT BLANK



ROYAL CANADIAN ARMY CADETS

GREEN STAR

INSTRUCTIONAL GUIDE



SECTION 10

EO C107.04 – ESTABLISH A FULL VALUE CONTRACT

Total Time:

30 min

PREPARATION

PRE-LESSON INSTRUCTIONS

Resources needed for the delivery of this lesson are listed in the lesson specification located in A-CR-CCP-701/PG-001, *Green Star Qualification Standard and Plan*, Chapter 4. Specific uses for said resources are identified throughout the instructional guide within the TP for which they are required.

Review the lesson content and become familiar with the material prior to delivering the lesson.

PRE-LESSON ASSIGNMENT

Nil.

APPROACH

An interactive lecture was chosen for TP 1 as it is an interactive way to introduce cadets to Full Value Contracts and to the elements needed prior to establishing the contract.

A practical activity was chosen for TP 2 to develop a full value contract as it is an interactive way to allow the cadet to develop, own, and build the desire to enforce agreed upon behavioural norms.

INTRODUCTION

REVIEW

Nil.

OBJECTIVES

By the end of this lesson the cadet will have contributed to the development of a group full value contract and will understand their role in enforcing behavioural norms.

IMPORTANCE

It is important for cadets to be involved in developing the Full Value Contract as it gives them a chance to voice their needs as well as hear their peers' needs. By doing so, they become aware of the behaviours that are required to ensure everyone in the group has a positive experience throughout the training year.

Teaching Point 1**Explain the elements needed to establish a Full Value Contract.**

Time: 5 min

Method: Interactive Lecture

FULL VALUE CONTRACT (FVC)

A Full Value contract is an agreement between members of a group. The members determine values and behaviours that will allow them to reach common goals and ensure everyone's physical and emotional safety. When those elements have been identified, members of the group determine how to best represent the agreement, whether it be by drawing or by any other creative mean.

Through a shared creation, and in words that are understandable to all cadets, the FVC allows cadets to understand what is expected of them, to commit to those expectations, and to accept responsibility for meeting those expectations.

The objectives of the FVC are to:

- respect integrity;
- respect diversity; and
- respect the individuals and the group to which the cadet belongs.

When instructors and cadets respect one another, and understand what each member required to feel respected, it is easier to work together toward the same goal and support everyone in the learning process.

CONDITIONS OF THE FVC

Before establishing a FVC, everyone must be ready to commit to common goals.

Be here. The FVC asks everyone to make a conscious commitment to be present in **body and mind**, as well as to commit to full **participation** and to accept and demonstrate responsibility for actions. This means that everyone will show interest in supporting each other and actively engaging in the learning process.

Be safe. In order to stimulate interest, facilitate participation and create an open-minded environment for the group members; everyone must feel safe. It is the instructor's responsibility to ensure that team members feel **physically and emotionally safe** in order to contribute to their learning process. This responsibility also falls on group members. Behaviours and attitudes must not put other group members at risk. A safe environment will encourage each member to actively participate, ask questions and give answers without fear of being ridiculed.

Set goals. It is essential that everyone set personal goals. These goals provide the person and the group reference points against which they will make choices about actions and plans. In every learning process, it is imperative to set goals. Once goals are set, group members and individuals will take on the responsibility to reach them. The FVC calls for the members of a group to work collectively toward the attainment of group goals and to support each other in meeting individual goals.

Be honest. Being honest assumes that everyone is honest with others and with oneself. For example, in a situation of disappointment or anger, the team members must simply acknowledge their feelings in regard to the situation and openly and fairly explain their state of mind. In this situation, everybody will be able to work toward solving the problem. Being honest requires members to be accountable to each other and responsible for their own actions and words.

Let go and move on. The FVC requires that group members acknowledge that they will not always agree and that they will have different opinions and ideas. In this instance, members must choose to put aside differences and move forward in order to achieve the goals.

Using a FVC

FVCs can be used differently, but often work on their own. They become team-building tools for the group. One can refer to a FVC after an activity, experience, or situation by asking to the group how they have acted and reacted. Normally, group members will refer to it even before a leader does. Group members must be able to identify by themselves what went well and what did not. They must also be able to identify what they need to improve in order to respect their "contract".

CONFIRMATION OF TEACHING POINT 1

QUESTIONS:

- Q1. What are the objectives of the FVC?
- Q2. What are the common guidelines to creating a FVC?

ANTICIPATED ANSWERS:

- A1. The three objectives of the FVC are:
- respect integrity;
 - respect diversity; and
 - respect the individuals and the group to which the cadet belongs
- A2. Before creating a FVC, cadets must commit to common goals. What are those goals?
- Be here
 - Be safe
 - Set goals
 - Be honest
 - Let go and move on

Teaching Point 2

Establish a Full Value Contract.

Time: 20 min

Method: Practical Activity



A full value contract can take many forms. Instructors should be creative in their approach to illustrating full value contracts. Once completed, the full value contract should be prominently displayed in a location where cadets can be reminded of the commitment they have made to the group.



Examples of Full Value Contracts are available at Attachment A.

ACTIVITY

Time: 20 min

OBJECTIVE

The objective of this activity is to develop a group FVC which will help create a positive environment for each individual member and the entire group.

RESOURCES

Depending on the type of FVC that will be constructed, the following resources may be required:

- flip chart paper,
- cardboard,
- markers,
- pens / pencils,
- ruler,
- glue,
- scissors,
- coloured paper, and
- magazines, etc.

ACTIVITY LAYOUT

Nil.

ACTIVITY INSTRUCTIONS

1. Have the cadets brainstorm values and qualities the group should adhere to in order to achieve goals.
2. Ensure all cadets have the same understanding of all the values and qualities noted.
3. Using flip chart paper to record ideas, have the cadets brainstorm a list of group behaviours that can help the group achieve goals.
4. Ensure all cadets have the same understanding of all the behaviours noted.
5. As an entire group, have the cadets represent their values and qualities by completing a FVC.

SAFETY

Nil.

WAYS TO REPRESENT THE FULL VALUE CONTRACT

There are a variety of ways to represent the full value contract. These include:

The Circle



Note. Created by D Cdt3, 2007, Ottawa ON: Department of National Defence.

Figure A-1 The Circle

In this representation of a FVC, a wheel is drawn. The inside circle represents the individuals, the group, and the goals. The outer circle symbolizes that the group is one and that all members go toward the same direction.

The rays that go from the inside circle to the outer circle represent the values selected by everyone in the group. Without the respect of those values, the group will not be able to go toward the same goals.

The Village

In this representation of a FVC, the instructor would draw a frame on a cardboard or flip chart paper.

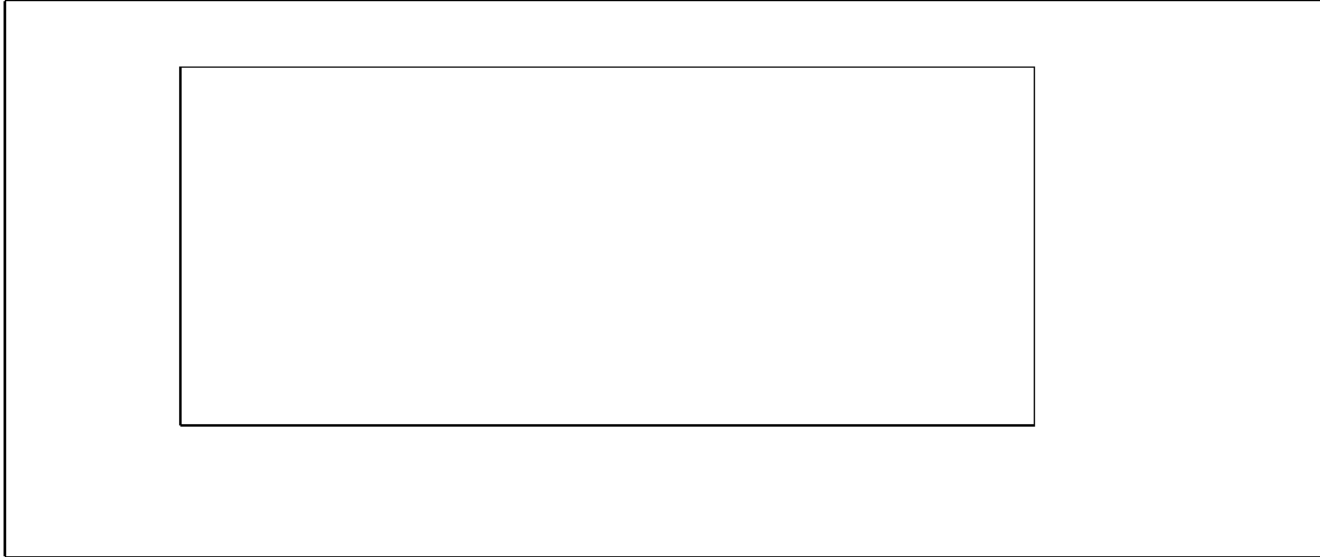

Note. Created by D Cdts 3, 2012, Ottawa ON: Department of National Defence.

Figure A-2 The Village

Then the cadets would be required to think about values, qualities, and behaviours that make them feel safe and respected, both as an individual and in a group setting. Every cadet would select their most important value, quality, or behaviour, and represent it in drawing or in writing on a piece of paper. Then, they would glue their drawing or writing inside the frame (village) and briefly explain to the others why that choice was made.

The activity would be repeated but this time, the cadets would identify things that would prevent the group from reaching their goals and destroy the running of the village. Once again, each cadet would select an item, represent it and explain to the group why they chose their representation. Then, they would glue their drawing or writing outside the frame (village).

Once the process is completed, the instructor must mention every value selected by the cadets (inside and outside the village) and ask if everyone agrees. The cadets must understand that they are agreeing to respect each person's value, quality or behaviour in order for the cadet corps (village) to run properly and be a place where everyone will feel safe and respected.

After everyone has agreed, everyone (staff and cadets) will sign the village.

The Five-Finger Contract



Note. Created by D Cdts 3, 2007, Ottawa ON: Department of National Defence.

Figure A-3 The Five Finger Contract

The cadets, as a group, determine a set of values that will help the group members feel secure, respected, and united. They will discuss those values to ensure that each cadet has a clear understanding of the values and that they agree that these values are important for the members of the group to function well together.

In this example above, five values were determined, and each value is represented by a finger on a hand, as follows:

- the little finger = safety,
- the ring finger = commitment,
- the middle finger = respect of others,
- the index finger = taking responsibilities, and
- the thumb = agreement to work toward the group's goals.

After everyone agrees on the values, the cadets will draw their hand on a sheet of paper and write inside each finger one of the values agreed upon. Each cadet will sign their hand and glue it on bristol board or flip chart paper. The set of the group's hands represents everyone's commitment to each other.

The Being



Note. From Adventure in the Classroom: Using Adventure to Strengthen Learning and Build a Community of Life-Long Learners (p. 74), by M. Henton, 1996, Dubuque, IA: Kendall Hunt Publishing. Copyright 1996 by Project Adventure, Inc.

Figure A-4 The Being

The outline of a cadet's body is drawn on a two pieces of flip chart paper, taped together.

Inside the outline, cadets draw or write the behaviours, qualities or values that will make the environment safe and a place where everyone is respected.

Outside the outline, the cadets draw or write the behaviours, qualities or values that will prevent the environment from being safe and a place where everyone is respected.

Cadets must agree on the meaning of each word and explain their choices.

When completed, all cadets sign the being.

The Chain Of Hands

The cadets write a list of words and sentences that describe how they would like to be treated and how they will treat the other group members in order to feel safe and respected.

From this list, they select the 10 most important for the group.

On a sheet of flip chart paper (two may be required), the cadets draw their hands around the sheet.

The 10 selected words or sentences are then written in the middle of the sheet.

The cadets sign their own hand.



Note. Created by D Cdts 3, 2007, Ottawa ON: Department of National Defence.

Figure A-5 The Chain of Hands

What do I Need? What can I Give?

The cadets are given two pieces of different coloured paper.

The instructor asks them to think about what they need in order to feel secure and respected in the group. They need to write the most important item they need on one of the pieces of paper.

Then, the instructor asks them to think about what they could provide to the group in order to have other team members feel safe and respected in the group. On the remaining piece of paper, they must write the most important one.

When done writing on both pieces of paper, the cadets present what they wrote to the group.

Once everyone has explained what they need and what they can provide, the cadets will glue those pieces of papers on cardboard or flip chart paper, making sure that both categories are split up.

Cadets are given an opportunity to ask questions about the items on the board.

Finally, everyone signs the board.

CHAPTER 8

PO 108 – PERFORM DRILL MOVEMENTS DURING AN ANNUAL CEREMONIAL REVIEW



**COMMON TRAINING
GREEN STAR
INSTRUCTIONAL GUIDE**



SECTION 1

EO M108.01 – ADOPT THE POSITIONS OF ATTENTION, STAND AT EASE AND STAND EASY

Total Time:

30 min

PREPARATION

PRE-LESSON INSTRUCTIONS

Resources needed for the delivery of this lesson are listed in the lesson specification located in A-CR-CCP-701/PF-001, *Green Star Qualification Standard and Plan*, Chapter 4. Specific uses for said resources are identified throughout the instructional guide within the TP for which they are required.

Review the lesson content and become familiar with the material prior to delivering the lesson.

PRE-LESSON ASSIGNMENT

Nil.

APPROACH

A demonstration and performance was chosen for this lesson as it allows the instructor to explain and demonstrate the skill the cadets are expected to acquire while providing an opportunity for the cadets to practice the skill under supervision.

INTRODUCTION

REVIEW

Nil.

OBJECTIVES

By the end of this lesson the cadet shall have adopted the positions of attention, stand at ease and stand easy.

IMPORTANCE

It is important for cadets to be able to perform drill movements at a competent level, developing sharpness, esprit-de-corps, physical coordination and alertness. These movements should be executed with ease ensuring that the cadets move together as one, which promotes discipline, alertness, precision, pride, steadiness and cohesion, and helps develop teamwork.



Develop and use a vocabulary of short, concise words to impress on the cadets that the movements must be performed smartly. For example, the words "crack", "drive", "seize" and "grasp" suggest the degree of smartness required. Profanity or personal sarcasm shall never be used.

Proper drill movements shall be combined with a professional demeanour throughout this lesson.



This lesson is broken down into movements. Explain demonstrate, and allow time for the cadets to practice, in a variety of positions.



Capitalization indicates the words of command for each movement.

Cadence is to be maintained when completing movements.



The term squad is a generic name for a group of cadets, used to teach drill movements. This term can be interchanged with platoon, flight, division or any other applicable elemental or regimental term.



Assistant instructors may be required for this lesson.

Teaching Point 1

Explain, demonstrate and have the cadets adopt the position of attention.

Time: 5 min

Method: Demonstration and Performance

ADOPT THE POSITION OF ATTENTION

The cadet shall adopt the position of attention, by ensuring:

1. heels are together and in line;
2. feet are turned out to form an angle of 30 degrees;
3. body is balanced and weight distributed evenly on both feet,
4. shoulders are level, square to the front,
5. arms are hanging as straight as the natural bend will allow, with elbows and wrists touching the body,

6. wrists are straight, the back of the hands outwards, fingers aligned, touching the palm of the hand, thumbs placed on the side of the forefinger at the middle joint with the thumbs and back of the fingers touching the thighs lightly and the thumbs in line with the seam of the trousers,
7. head is held erect, neck touching the back of the collar, eyes steady, looking their height and straight to the front, and
8. no part of the body is strained.

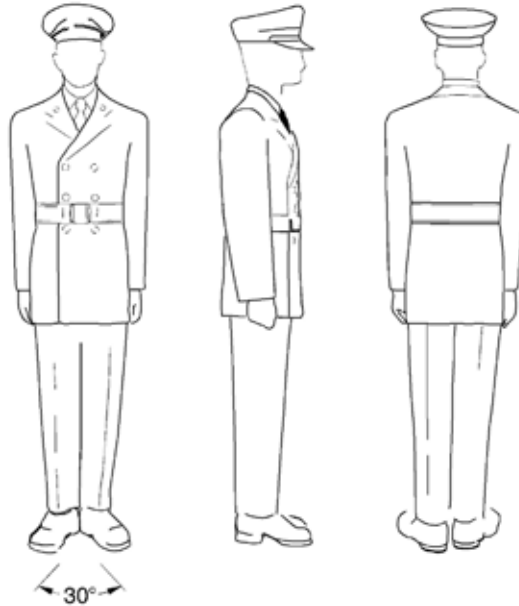

Note. From The Canadian Forces Manual of Drill and Ceremonial (p. 2-3), by Director of History and Heritage 3-2, 2006, Ottawa, ON: Department of National Defence.

Figure 1 Position of Attention



Note. From The Canadian Forces Manual of Drill and Ceremonial (p. 2-3), by Director of History and Heritage 3-2, 2006, Ottawa, ON: Department of National Defence.

Figure 2 Fists at Position of Attention



Practice the movements with:

- the **instructor** calling the time;
- the **squad** calling the time; and
- the squad **judging** the time.

Emphasize any movements with which the cadets had difficulty during the TP.



Constant checking and correcting of all faults is essential. Faults shall be corrected immediately after they occur.

Common faults include:

- back arched or hips too far forward,
- shoulders and body tense,
- leaning to the front or rear,
- thumbs not along the seams of the trousers, and,
- feet placed at an improper angle.

CONFIRMATION OF TEACHING POINT 1

The cadets' adopting the position of attention will serve as the confirmation of this TP.

Teaching Point 2

Explain, demonstrate and have the cadets adopt the position of stand at ease.

Time: 5 min

Method: Demonstration and Performance

ADOPT THE POSITION OF STAND AT EASE

The position of standing at ease is an intermediate position between attention and standing easy. It allows no relaxation, but can be maintained without strain for a longer time than the position of attention.

On the command STAND AT EASE BY NUMBERS, SQUAD—ONE, the cadet shall bend the left knee.



Note. From The Canadian Forces Manual of Drill and Ceremonial (p. 2-4), by Director of History and Heritage 3-2, 2005, Ottawa, ON: Department of National Defence.

Figure 3 First Part of the Movement – Stand at Ease



Constant checking and correcting of all faults is essential. Faults shall be corrected immediately after they occur.

Common faults include:

- arms not held straight and firmly to the sides,
- moving wrong foot,
- lifting the foot instead of bending the knee, and
- lower leg and foot hanging at an unnatural angle.

On the command SQUAD—TWO, the cadet shall:

1. ensure heels are together and in line;
2. carry the left foot to the left, straightening it in double time, and place it smartly flat on the ground with the inside of the heels 25 cm apart;
3. simultaneously, with a quick motion, bring the arms behind the back, stretched to their full extent, and place the back of the right hand in the palm of the left, with thumbs crossed right over left, the fingers together and extended; and
4. balance the body with the weight evenly distributed on both feet.

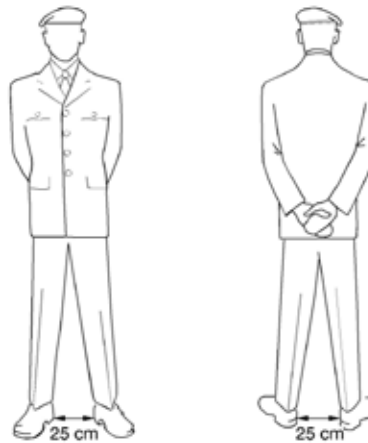

Note. From The Canadian Forces Manual of Drill and Ceremonial (p. 2-4), by Director of History and Heritage 3-2, 2006, Ottawa, ON: Department of National Defence.

Figure 4 Position of Stand at Ease



Practice the movements with:

- the **instructor** calling the time;
- the **squad** calling the time; and
- the squad **judging** the time.

Emphasize any movements with which the cadets had difficulty during the TP.



Constant checking and correcting of all faults is essential. Faults shall be corrected immediately after they occur.

Common faults include:

- foot carried over an improper distance,
- right hand not placed fully into palm of the left hand,
- thumbs hooked together, and
- straining the arms in an attempt to lock the elbows

CONFIRMATION OF TEACHING POINT 2

The cadets' adopting the position of stand at ease will serve as the confirmation of this TP.

Teaching Point 3

Explain, demonstrate and have the cadets adopt the position of attention from stand at ease.

Time: 5 min

Method: Demonstration and Performance

ADOPT THE POSITION OF STAND AT EASE

On the command ATTENTION BY NUMBERS, SQUAD—ONE, bend the left knee and shift the balance to the right foot.

On the command SQUAD—TWO, the cadet shall:

1. straighten the left leg in double time, place the foot on the ground, toe touching first, followed by the heel, and with heels aligned; and
2. simultaneously, with a quick motion, bring the arms and hands to the position of attention.

On the command ATTEN—TION, combine the two movements. The timing is “ONE.”



Constant checking and correcting of all faults is essential. Faults shall be corrected immediately after they occur.

Common faults are the same as standing at attention and stand at ease.

CONFIRMATION OF TEACHING POINT 3

The cadets' adopting the position of attention from stand at ease will serve as the confirmation of this TP.

Teaching Point 4**Explain, demonstrate and have the cadets adopt the position of stand easy.**

Time: 5 min

Method: Demonstration and Performance

ADOPT THE POSITION OF STAND EASY

The position of stand easy is ordered when the squad may relax. This command is only given when the squad is in the position of stand at ease.

On the command STAND—EASY, the cadet shall close the hands and bring the arms to the position of attention and relax.

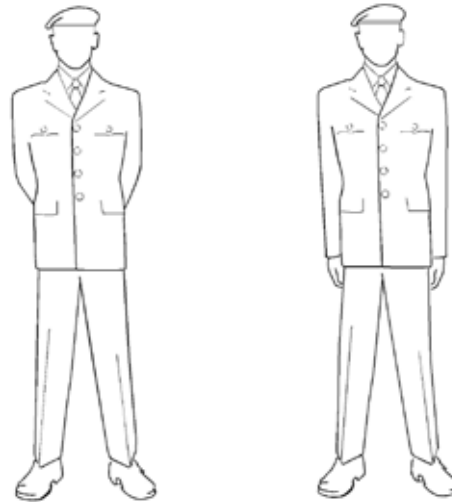

Note. From The Canadian Forces Manual of Drill and Ceremonial (p. 2-5), by Director of History and Heritage 3-2, 2006, Ottawa, ON: Department of National Defence.

Figure 5 Position of Stand Easy



When standing easy, with permission, cadets may adjust clothing and equipment, but shall not move feet or talk.



Constant checking and correcting of all faults is essential. Faults shall be corrected immediately after they occur.

Common faults include moving or fidgeting and talking without permission.

CONFIRMATION OF TEACHING POINT 4

The cadets' adopting the position of stand easy will serve as the confirmation of this TP.

Teaching Point 5

Explain, demonstrate and have the cadets adopt the position of stand at ease from stand easy.

Time: 5 min

Method: Demonstration and Performance

ADOPT THE POSITION OF STAND AT EASE FROM STAND EASY

On the cautionary command SQUAD, the cadet shall assume the position of stand at ease.



This TP is best taught as a group practice to ensure adherence to timings and togetherness of the squad.



Constant checking and correcting of all faults is essential. Faults shall be corrected immediately after they occur.

Common faults include not paying attention.

CONFIRMATION OF TEACHING POINT 5

The cadets' adopting the position of stand at ease from stand easy will serve as the confirmation of this TP.

END OF LESSON CONFIRMATION

The cadets' adopting the positions of attention, stand at ease and stand easy will serve as the confirmation of this lesson.

CONCLUSION

HOMEWORK / READING / PRACTICE

Nil.

METHOD OF EVALUATION

Nil.

CLOSING STATEMENT

Drill develops and reinforces in cadets many qualities such as patience and determination through self-discipline and practice. Drill requires that cadets move together as one, which promotes discipline, alertness, precision, pride, steadiness and cohesion, and helps develop teamwork.

INSTRUCTOR NOTES / REMARKS

It is recommended that ongoing feedback be provided to the cadets during drill practices, parade nights and ceremonial parades. All corrections shall be made immediately so that bad habits do not persist.

REFERENCES

A0-002 A-DH-201-000/PT-001 Director History and Heritage 3-2. (2006). *The Canadian Forces manual of drill and ceremonial*. Ottawa, ON: Department of National Defence.

THIS PAGE INTENTIONALLY LEFT BLANK



COMMON TRAINING
GREEN STAR
INSTRUCTIONAL GUIDE



SECTION 2

EO M108.02 – EXECUTE A SALUTE AT THE HALT WITHOUT ARMS

Total Time:

30 min

PREPARATION

PRE-LESSON INSTRUCTIONS

Resources needed for the delivery of this lesson are listed in the lesson specification located in A-CR-CCP-701/PF-001, *Green Star Qualification Standard and Plan*, Chapter 4. Specific uses for said resources are identified throughout the instructional guide within the TP for which they are required.

Review the lesson content and become familiar with the material prior to delivering the lesson.

PRE-LESSON ASSIGNMENT

Nil.

APPROACH

A demonstration and performance was chosen for this lesson as it allows the instructor to explain and demonstrate the skill the cadets are expected to acquire while providing an opportunity for the cadets to practice the skill under supervision.

INTRODUCTION

REVIEW

Review the drill movements from EO M108.01 (Adopt the Positions of Attention, Stand at Ease and Stand Easy).

OBJECTIVES

By the end of this lesson the cadet shall have executed a salute at the halt without arms.

IMPORTANCE

It is important for cadets to be able to perform drill movements at a competent level, developing sharpness, esprit-de-corps, physical coordination and alertness. These movements should be executed with ease ensuring that the cadets move together as one, which promotes discipline, alertness, precision, pride, steadiness and cohesion, and helps develop teamwork.



Develop and use a vocabulary of short, concise words to impress on the cadets that the movements must be performed smartly. For example, the words "crack", "drive", "seize" and "grasp" suggest the degree of smartness required. Profanity or personal sarcasm shall never be used.

Proper drill movements shall be combined with a professional demeanour throughout this lesson.



This lesson is broken down into movements. Explain, demonstrate and allow time for the cadets to practice, in a variety of positions.



Capitalization indicates the words of command for each movement.

Cadence is to be maintained when completing movements.



The term squad is a generic name for a group of cadets, used to teach drill movements. This term can be interchanged with platoon, flight, division or any other applicable elemental or regimental term.



Assistant instructors may be required for this lesson.

Teaching Point 1

Explain, demonstrate and have the cadets execute a salute to the front.

Time: 15 min

Method: Demonstration and Performance

EXECUTE A SALUTE TO THE FRONT



The salute is given with the right hand. When physical incapacity or carrying of articles makes a salute with the right hand impracticable, compliments will be paid by turning the head and eyes to the left or right or standing to attention.

On the command TO THE FRONT SALUTE BY NUMBERS, SQUAD—ONE, the cadet shall:

1. bend the right elbow and open the palm of the right hand as it passes the shoulder; and

2. force the right hand by its shortest route to the front of the headdress ensuring:
- (a) the palm of the hand is facing down,
 - (b) the thumb and fingers are fully extended and close together,
 - (c) the tip of the second finger is 2 cm above and in line with the outside of the right eyebrow and touching the lower edge of the headdress,
 - (d) the hand, wrist and forearm are in a straight line and at a 45 degree angle to the upper arm,
 - (e) the elbow is in line with the shoulders, and
 - (f) the upper arm is parallel to the ground.

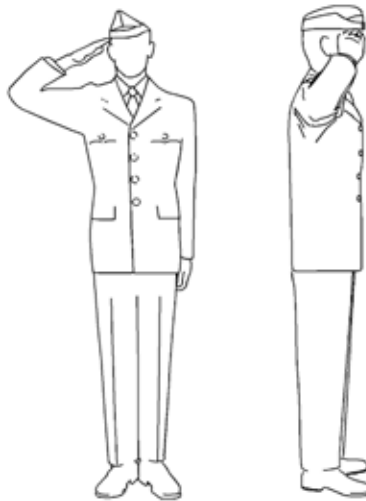

Note. From The Canadian Forces Manual of Drill and Ceremonial (p. 2-3), by Director of History and Heritage 3-2, 2006, Ottawa, ON: Department of National Defence.

Figure 1 Saluting to the Front Without Arms



Practice the movements with:

- the **instructor** calling the time;
- the **squad** calling the time; and
- the squad **judging** the time.



Constant checking and correcting of all faults is essential. Faults shall be corrected immediately after they occur.

Common faults include:

- second finger not touching the headdress,
- wrist and fingers not straight,
- thumb not in line with the fingers,
- palm turned to face forward or to the rear, and
- second finger touching the arm of glasses, if worn.

On the command SQUAD—TWO, the hand is brought sharply to the position of attention, and simultaneously the head and eyes are turned to the front.



Practice the movements with:

- the **instructor** calling the time;
- the **squad** calling the time; and
- the squad **judging** the time.

On the command TO THE FRONT—SALUTE, the two movements are combined. The standard pause shall be observed between movements.



Standard Pause: The standard pause between each movement is two beats in quick time.



Practice the movements with:

- the **instructor** calling the time;
- the **squad** calling the time; and
- the squad **judging** the time.

Emphasize any movements with which the cadets had difficulty during the TP.

CONFIRMATION OF TEACHING POINT 1

The cadets' executing a salute to the front will serve as the confirmation of this TP.

Teaching Point 2**Explain, demonstrate and have the cadets execute a salute to the right and to the left.**

Time: 10 min

Method: Demonstration and Performance

EXECUTE A SALUTE TO THE RIGHT AND TO THE LEFT

On the command TO THE RIGHT (LEFT) SALUTE BY NUMBERS, SQUAD—ONE, saluting shall be executed as detailed in TP1, except that the head and eyes shall be turned smartly to the right (left) as far as possible without straining, ensuring that:

1. when saluting to the left, the right hand, wrist and arm are brought further over to the left to the correct position 2 cm above and in line with the outside edge of the right eyebrow and touching the headdress; and
2. when saluting to the right, the arm is moved to the rear, with the tip of the second finger remaining 2 cm above and in line with the outside edge of the right eyebrow and touching the headdress.

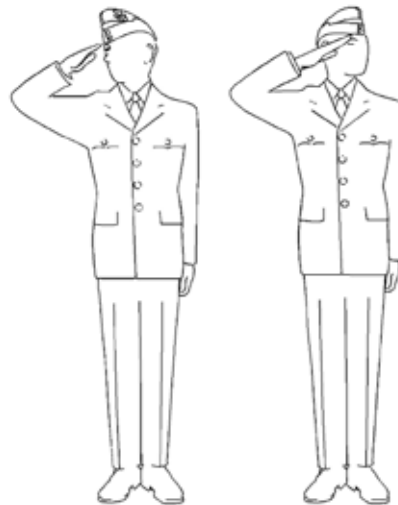

Note. From The Canadian Forces Manual of Drill and Ceremonial (p. 2-11), by Director of History and Heritage 3-2, 2006, Ottawa, ON: Department of National Defence.

Figure 2 Saluting to the Right and Left



Constant checking and correcting of all faults is essential. Faults shall be corrected immediately after they occur.

Common faults are the same as saluting to the front.

On the command SQUAD—TWO, the hand is brought sharply to the position of attention, and simultaneously the head and eyes are turned smartly to the front



Practice the movements with:

- the **instructor** calling the time;
- the **squad** calling the time; and
- the squad **judging** the time.

Emphasize any movements with which the cadets had difficulty during the TP.

On the command TO THE RIGHT (LEFT)—SALUTE, the two movements are combined. The standard pause shall be observed between movements.



Practice the movements with:

- the **instructor** calling the time;
- the **squad** calling the time; and
- the squad **judging** the time.

Emphasize any movements with which the cadets had difficulty during the lesson.

CONFIRMATION OF TEACHING POINT 2

The cadets' executing a salute to the right and to the left will serve as the confirmation of this TP.

END OF LESSON CONFIRMATION

The cadets' executing a salute at the halt without arms will serve as the confirmation of this lesson.

CONCLUSION

HOMEWORK / READING / PRACTICE

Nil.

METHOD OF EVALUATION

Nil.

CLOSING STATEMENT

Drill develops and reinforces in cadets many qualities such as patience and determination through self-discipline and practice. Drill requires that cadets move together as one, which promotes discipline, alertness, precision, pride, steadiness and cohesion, and helps develop teamwork.

INSTRUCTOR NOTES / REMARKS

It is recommended that ongoing feedback be provided to the cadets during drill practices, parade nights and ceremonial parades. All corrections shall be made immediately so that bad habits do not persist.

REFERENCES

A0-002 A-DH-201-000/PT-001 Director History and Heritage 3-2. (2006). *The Canadian Forces manual of drill and ceremonial*. Ottawa, ON: Department of National Defence.

THIS PAGE INTENTIONALLY LEFT BLANK



COMMON TRAINING
GREEN STAR
INSTRUCTIONAL GUIDE



SECTION 3
EO M108.03 – EXECUTE TURNS AT THE HALT

Total Time:

30 min

PREPARATION

PRE-LESSON INSTRUCTIONS

Resources needed for the delivery of this lesson are listed in the lesson specification located in A-CR-CCP-701/PF-001, *Green Star Qualification Standard and Plan*, Chapter 4. Specific uses for said resources are identified throughout the instructional guide within the TP for which they are required.

Review the lesson content and become familiar with the material prior to delivering the lesson.

PRE-LESSON ASSIGNMENT

Nil.

APPROACH

A demonstration and performance was chosen for this lesson as it allows the instructor to explain and demonstrate the skill the cadets are expected to acquire while providing an opportunity for the cadets to practice the skill under supervision.

INTRODUCTION

REVIEW

Review the drill movements from EO M108.02 (Execute a Salute at the Halt Without Arms).

OBJECTIVES

By the end of this lesson the cadet shall have executed turns at the halt.

IMPORTANCE

It is important for cadets to be able to perform drill movements at a competent level, developing sharpness, esprit-de-corps, physical coordination and alertness. These movements should be executed with ease ensuring that the cadets move together as one, which promotes discipline, alertness, precision, pride, steadiness and cohesion, and helps develop teamwork



Develop and use a vocabulary of short, concise words to impress on the cadets that the movements must be performed smartly. For example, the words "crack", "drive", "seize" and "grasp" suggest the degree of smartness required. Profanity or personal sarcasm shall never be used.

Proper drill movements shall be combined with a professional demeanour throughout this lesson.



This lesson is broken down into movements. Explain, demonstrate and allow time for the cadets to practice, in a variety of positions.



Capitalization indicates the words of command for each movement.

Cadence is to be maintained when completing movements.



The term squad is a generic name for a group of cadets, used to teach drill movements. This term can be interchanged with platoon, flight, division or any other applicable elemental or regimental term.



Assistant instructors may be required for this lesson.

Teaching Point 1

Explain, demonstrate and have the cadets execute a right turn.

Time: 10 min

Method: Demonstration and Performance

EXECUTE A RIGHT TURN



Turns are made to change direction. Right or left turns change direction by 90 degrees, and about turns by 180 degrees.

On the command RIGHT TURN BY NUMBERS, SQUAD—ONE, the cadets shall turn 90 degrees to the right by pivoting on the right heel and left toe and raising the left heel and right toe simultaneously. Both knees should be kept braced during the turn, arms at the sides and body erect. On the completion of the movement, the weight of the body is placed on the right foot and the left leg is braced with the heel off the ground.

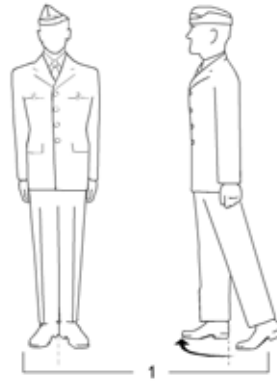

Note. From The Canadian Forces Manual of Drill and Ceremonial (p. 2-13), by Director of History and Heritage 3-2, 2006, Ottawa, ON: Department of National Defence.

Figure 1 First Part of the Movement—Right Turn at the Halt



Practice the movements with:

- the **instructor** calling the time;
- the **squad** calling the time; and
- the squad **judging** the time.



Constant checking and correcting of all faults is essential. Faults shall be corrected immediately after they occur.

Common faults include:

- weight transferred to the left foot,
- right leg bent instead of straight, and
- arms not held firmly to the side.

On the command SQUAD—TWO, the cadets shall bend the left knee, straightening it in double time and placing the left foot beside the right to assume the position of attention.

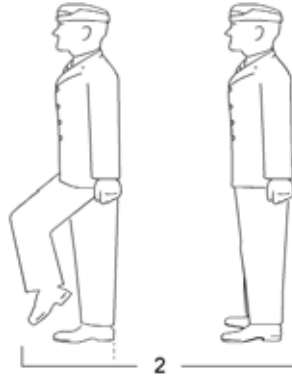

Note. From The Canadian Forces Manual of Drill and Ceremonial (p. 2-13), by Director of History and Heritage 3-2, 2006, Ottawa, ON: Department of National Defence.

Figure 2 Second Part of the Movement—Right Turn at the Halt



Practice the movements with:

- the **instructor** calling the time;
- the **squad** calling the time; and
- the squad **judging** the time.



Constant checking and correcting of all faults is essential. Faults shall be corrected immediately after they occur.

Common faults include:

- arms not held straight and firmly to the sides,
- moving wrong foot,
- lifting the foot rather than lifting the knee, and
- lower leg and foot not allowed to hang at a natural angle.

On the command RIGHT—TURN, combine the two movements. The standard pause shall be observed between the movements.



Standard Pause: The standard pause between each movement is two beats in quick time.



Practice the movement with:

- the **instructor** calling the time;
- the **squad** calling the time; and
- the squad **judging** the time.

Emphasize any movements with which the cadets had difficulty during the TP.

CONFIRMATION OF TEACHING POINT 1

The cadets' executing a right turn will serve as the confirmation of this TP.

Teaching Point 2

Explain, demonstrate and have the cadets execute a left turn.

Time: 5 min

Method: Demonstration and Performance

EXECUTE A LEFT TURN

On the command LEFT TURN BY NUMBERS, SQUAD–ONE, have the cadets turn 90 degrees to the left by pivoting on the left heel and right toe and raising the right heel and left toe simultaneously. Both knees should be kept braced during the turn, arms at the sides and body erect. On the completion of the movement, the weight of the body is placed on the left foot and the right leg is braced with the heel off the ground.



Constant checking and correcting of all faults is essential. Faults shall be corrected immediately after they occur.

Common faults are the same as turning to the right except that references to left and right are to be reversed.

On the command SQUAD–TWO, the hand is brought sharply to the position of attention, and simultaneously the head and eyes are turned smartly to the front



Practice the movements with:

- the **instructor** calling the time;
- the **squad** calling the time; and
- the squad **judging** the time.

On the command LEFT – TURN, combine the two movements. The standard pause shall be observed between the movements.



Practice the movements with:

- the **instructor** calling the time;
- the **squad** calling the time; and
- the squad **judging** the time.

Emphasize any movements with which the cadets had difficulty during the TP.

CONFIRMATION OF TEACHING POINT 2

The cadets' executing a left turn will serve as the confirmation of this TP.

Teaching Point 3

Explain, demonstrate and have the cadets execute an about turn.

Time: 10 min

Method: Demonstration and Performance

EXECUTE AN ABOUT TURN

On the command ABOUT TURN BY NUMBERS, SQUAD—ONE, the cadets shall turn 180 degrees to the right by pivoting on the right heel and left toe and raising the left heel and right toe simultaneously. Both knees should be kept braced during the turn, arms at the sides and body erect. On the completion of the movement, the weight of the body is placed on the right foot and the left leg is braced with the heel off the ground.

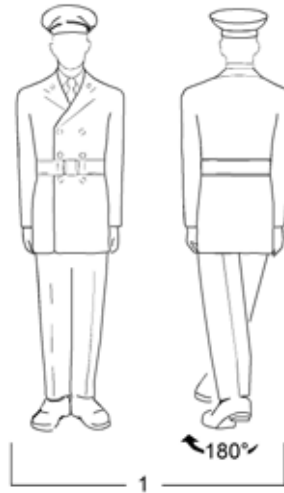

Note. From The Canadian Forces Manual of Drill and Ceremonial (p. 2-14), by Director of History and Heritage 3-2, 2006, Ottawa, ON: Department of National Defence.

Figure 3 First Part of the Movement—About Turn at the Halt



Practice the movements with:

- the **instructor** calling the time;
- the **squad** calling the time; and
- the squad **judging** the time.



Constant checking and correcting of all faults is essential. Faults shall be corrected immediately after they occur.

Common faults include the ones listed for the right turn and also include:

- turning to the left instead of the right,
- turning less than or more than 180 degrees, and
- losing balance.

On the command SQUAD—TWO, the cadet shall bend the left knee, straightening it in double time and placing the left foot beside the right to assume the position of attention.

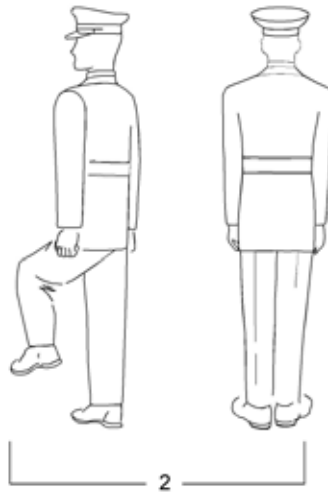

Note. From The Canadian Forces Manual of Drill and Ceremonial (p. 2-14), by Director of History and Heritage 3-2, 2006, Ottawa, ON: Department of National Defence.

Figure 4 Second Part of the Movement—About Turn at the Halt

On the command ABOUT—TURN, combine the two movements. The standard pause shall be observed between the movements.



Practice the movements with:

- the **instructor** calling the time;
- the **squad** calling the time; and
- the squad **judging** the time.

Emphasize any movements with which the cadets had difficulty during the lesson.



Constant checking and correcting of all faults is essential. Faults shall be corrected immediately after they occur.

Common faults are the same as executing a right turn.

CONFIRMATION OF TEACHING POINT 3

The cadets' executing an about turn will serve as the confirmation of this TP.

END OF LESSON CONFIRMATION

The cadets' executing turns at the halt will serve as the confirmation of this lesson.

CONCLUSION

HOMEWORK / READING / PRACTICE

Nil.

METHOD OF EVALUATION

Nil.

CLOSING STATEMENT

Drill develops and reinforces in cadets many qualities such as patience and determination through self-discipline and practice. Drill requires that cadets move together as one, which promotes discipline, alertness, precision, pride, steadiness and cohesion, and helps develop teamwork.

INSTRUCTOR NOTES / REMARKS

It is recommended that ongoing feedback be provided to the cadets during drill practices, parade nights and ceremonial parades. All corrections shall be made immediately so that bad habits do not persist.

REFERENCES

A0-002 A-DH-201-000/PT-001 Director History and Heritage 3-2. (2006). *The Canadian Forces manual of drill and ceremonial*. Ottawa, ON: Department of National Defence.



**COMMON TRAINING
GREEN STAR
INSTRUCTIONAL GUIDE**



**SECTION 4
EO M108.04 – CLOSE TO THE RIGHT AND LEFT**

Total Time:

30 min

PREPARATION

PRE-LESSON INSTRUCTIONS

Resources needed for the delivery of this lesson are listed in the lesson specification located in A-CR-CCP-701/PF-001, *Green Star Qualification Standard and Plan*, Chapter 4. Specific uses for said resources are identified throughout the instructional guide within the TP for which they are required.

Review the lesson content and become familiar with the material prior to delivering the lesson.

PRE-LESSON ASSIGNMENT

Nil.

APPROACH

A demonstration and performance was chosen for this lesson as it allows the instructor to explain and demonstrate the skill the cadets are expected to acquire while providing an opportunity for the cadets to practice the skill under supervision.

INTRODUCTION

REVIEW

Review the drill movements from EO M108.03 (Execute Turns at the Halt).

OBJECTIVES

By the end of this lesson the cadet shall have closed to the right and left.

IMPORTANCE

It is important for cadets to be able to perform drill movements at a competent level, developing sharpness, esprit-de-corps, physical coordination and alertness. These movements should be executed with ease ensuring that the cadets move together as one, which promotes discipline, alertness, precision, pride, steadiness and cohesion, and helps develop teamwork.



Develop and use a vocabulary of short, concise words to impress on the cadets that the movements must be performed smartly. For example, the words "crack", "drive", "seize" and "grasp" suggest the degree of smartness required. Profanity or personal sarcasm shall never be used.

Proper drill movements shall be combined with a professional demeanour throughout this lesson.



This lesson is broken down into movements. Explain, demonstrate and allow time for the cadets to practice, in a variety of positions.



Capitalization indicates the words of command for each movement.

Cadence is to be maintained when completing movements.



The term squad is a generic name for a group of cadets, used to teach drill movements. This term can be interchanged with platoon, flight, division or any other applicable elemental or regimental term.



Assistant instructors may be required for this lesson.

Teaching Point 1

Explain, demonstrate and have the cadets close to the right.

Time: 15 min

Method: Demonstration and Performance

CLOSE TO THE RIGHT



Closing to the right is executed to adjust position right. Close march paces to the right shall not be ordered when the distance required to move exceeds eight paces. When the distance is greater, the squad shall be turned and marched the required distance.

On the command ONE PACE RIGHT CLOSE MARCH BY NUMBERS, SQUAD–ONE, the cadet shall:

1. bend the right knee, carrying the foot to the right and placing it on the ground with the inside of the heels one side pace 25 cm apart;
2. balance the weight of the body evenly on both feet; and
3. keep the arms at the sides.



Practice the movements with:

- the **instructor** calling the time;
- the **squad** calling the time; and
- the squad **judging** the time.



Constant checking and correcting of all faults is essential. Faults shall be corrected immediately after they occur.

Common faults include:

- arms not held straight and firmly to the sides,
- wrong foot moved,
- foot is lifted instead of bending the knee, and
- lower leg and foot hanging at an unnatural angle.

On the command SQUAD—TWO, the cadet shall shift the weight of the body to the right foot; and bend the left knee, placing the left foot by the right to assume the position of attention.



Practice the movements with:

- the **instructor** calling the time;
- the **squad** calling the time; and
- the squad **judging** the time.



Constant checking and correcting of all faults is essential. Faults shall be corrected immediately after they occur.

Common faults are the same as the first movement.

On the command ONE PACE RIGHT CLOSE—MARCH, combine the two movements, observing the following timing:

1. one pace, one-one,
2. two paces, one-one, pause, one-two: and
3. three paces, one-one, pause, one-two, pause, one-three.

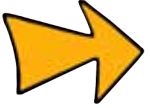

Standard Pause: The standard pause between each movement is two beats in quick time.



Practice the movement with:

- the **instructor** calling the time;
- the **squad** calling the time; and
- the squad **judging** the time.

Emphasize any movements with which the cadets had difficulty with during the TP.

CONFIRMATION OF TEACHING POINT 1

The cadets' closing to the right will serve as the confirmation of this TP.

Teaching Point 2

Explain, demonstrate and have the cadets close to the left.

Time: 10 min

Method: Demonstration and Performance

CLOSE TO THE LEFT

On the command ONE PACE LEFT CLOSE MARCH BY NUMBERS, SQUAD—ONE, the cadet shall:

1. bend the left knee, carrying the foot to the left and placing it on the ground with the inside of the heels one side pace 25 cm apart;
2. balance the weight of the body evenly on both feet; and
3. keep the arms still at the sides.



Practice the movements with:

- the **instructor** calling the time;
- the **squad** calling the time; and
- the squad **judging** the time.



Constant checking and correcting of all faults is essential. Faults shall be corrected immediately after they occur.

Common faults are the same as closing to the right except with the left foot.

On the command SQUAD—TWO, the cadet shall shift the weight of the body to the left foot; and bend the right knee, placing the right foot by the left to assume the position of attention.



Practice the movements with:

- the **instructor** calling the time;
- the **squad** calling the time; and
- the squad **judging** the time.



Constant checking and correcting of all faults is essential. Faults shall be corrected immediately after they occur.

Common faults are the same as the first movement.

On the command ONE PACE LEFT CLOSE—MARCH, combine the two movements, observing the following timing:

1. one pace, one-one;
2. two paces, one-one, pause, one-two; and
3. three paces, one-one, pause, one-two, pause, one-three.



Practice the movement with:

- the **instructor** calling the time;
- the **squad** calling the time; and
- the squad **judging** the time.

Emphasize any movements with which the cadets had difficulty during the lesson.

CONFIRMATION OF TEACHING POINT 2

The cadets' closing to the left will serve as the confirmation of this TP.

END OF LESSON CONFIRMATION

The cadets' closing to the right and left will serve as the confirmation of this lesson.

CONCLUSION

HOMework / READING / PRACTICE

Nil.

METHOD OF EVALUATION

Nil.

CLOSING STATEMENT

Drill develops and reinforces in cadets many qualities such as patience and determination through self-discipline and practice. Drill requires that cadets move together as one, which promotes discipline, alertness, precision, pride, steadiness and cohesion, and helps develop teamwork.

INSTRUCTOR NOTES / REMARKS

It is recommended that ongoing feedback be provided to the cadets during drill practices, parade nights and ceremonial parades. All corrections shall be made immediately so that bad habits do not persist.

REFERENCES

A0-002 A-DH-201-000/PT-001 Director History and Heritage 3-2. (2006). *The Canadian Forces manual of drill and ceremonial*. Ottawa, ON: Department of National Defence.



**COMMON TRAINING
GREEN STAR
INSTRUCTIONAL GUIDE**



SECTION 5

EO M108.05 – EXECUTE PACES FORWARD AND TO THE REAR

Total Time:

30 min

PREPARATION

PRE-LESSON INSTRUCTIONS

Resources needed for the delivery of this lesson are listed in the lesson specification located in A-CR-CCP-701/PF-001, *Green Star Qualification Standard and Plan*, Chapter 4. Specific uses for said resources are identified throughout the instructional guide within the TP for which they are required.

Review the lesson content and become familiar with the material prior to delivering the lesson.

PRE-LESSON ASSIGNMENT

Nil.

APPROACH

A demonstration and performance was chosen for this lesson as it allows the instructor to explain and demonstrate the skill the cadets are expected to acquire while providing an opportunity for the cadets to practice the skill under supervision.

INTRODUCTION

REVIEW

Review the drill movements from EO M108.04 (Execute to the Right and Left).

OBJECTIVES

By the end of this lesson the cadet shall have executed paces forward and to the rear.

IMPORTANCE

It is important for cadets to be able to perform drill movements at a competent level, developing sharpness, esprit-de-corps, physical coordination and alertness. These movements should be executed with ease ensuring that the cadets move together as one, which promotes discipline, alertness, precision, pride, steadiness and cohesion, and helps develop teamwork.



Develop and use a vocabulary of short, concise words to impress on the cadets that the movements must be performed smartly. For example, the words "crack", "drive", "seize" and "grasp" suggest the degree of smartness required. Profanity or personal sarcasm shall never be used.

Proper drill movements shall be combined with a professional demeanour throughout this lesson.



This lesson is broken down into movements. Explain, demonstrate and allow time for the cadets to practice, in a variety of positions.



Capitalization indicates the words of command for each movement.

Cadence is to be maintained when completing movements.



The term squad is a generic name for a group of cadets, used to teach drill movements. This term can be interchanged with platoon, flight, division or any other applicable elemental or regimental term.



Assistant instructors may be required for this lesson.

Teaching Point 1

Explain, demonstrate and have the cadets execute paces forward.

Time: 15 min

Method: Demonstration and Performance

PACES FORWARD



Paces forward are executed to adjust position forward and should not exceed three paces. When the distance is greater, the squad shall be marched the required distance.

On the command ONE PACE FORWARD MARCH BY NUMBERS, SQUAD—ONE, the cadet shall shoot the left foot forward one half pace, force the weight forward on the left foot, with the right heel raised; and keep the arms still at the sides.



Practice the movements with:

- the **instructor** calling the time;
- the **squad** calling the time; and
- the squad **judging** the time.



Constant checking and correcting of all faults is essential. Faults shall be corrected immediately after they occur.

Common faults include:

- incorrect pace size,
- step off with incorrect foot, and
- arms not held firmly at the sides.

On the command SQUAD—TWO, the cadet shall bend the right knee, straighten it in double time, place the right foot on the ground beside the left; and assume the position of attention.



Practice the movements with:

- the **instructor** calling the time;
- the **squad** calling the time; and
- the squad **judging** the time.



Constant checking and correcting of all faults is essential. Faults shall be corrected immediately after they occur.

Common faults include:

- arms not held straight and firmly to the sides,
- wrong foot moved,
- foot is lifted instead of bending the knee, and
- lower leg and foot hanging at an unnatural angle

On the command ONE PACE FORWARD—MARCH, combine the two movements, observing the following timing:

1. one pace, one-two;
2. two paces, one, one-two; and
3. three paces, one, one, one-two.

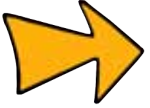

When taking paces forward:

1. The cadence shall be in quick time.
2. The length of each step shall be one half pace (35 cm).
3. The arms shall be kept still at the sides.
4. When two paces forward are taken, the left foot is brought into the right to assume the position of attention.



Practice the movement with:

- the **instructor** calling the time;
- the **squad** calling the time; and
- the squad **judging** the time.

Emphasize any movements with which the cadets had difficulty during the TP.

CONFIRMATION OF TEACHING POINT 1

The cadets' executing paces forward will serve as the confirmation of this TP.

Teaching Point 2

Explain, demonstrate and have the cadets execute paces to the rear.

Time: 10 min

Method: Demonstration and Performance

PACES TO THE REAR



Paces to the rear are executed to adjust position back and should not exceed three paces. When the distance is greater, the squad shall be marched the required distance.

On the command ONE PACE STEP BACK MARCH BY NUMBERS, SQUAD—ONE, the cadet shall shoot the left foot to the rear one half pace with the weight forward on the right foot and the left heel raised; and keep their arms still at the sides.



Practice the movements with:

- the **instructor** calling the time;
- the **squad** calling the time; and
- the squad **judging** the time.



Constant checking and correcting of all faults is essential. Faults shall be corrected immediately after they occur.

Common faults are the same as executing paces forward.

On the command SQUAD—TWO, the cadet shall bend the right knee, straighten it in double time, place the right foot on the ground beside the left; and assume the position of attention.



Practice the movements with:

- the **instructor** calling the time;
- the **squad** calling the time; and
- the squad **judging** the time.



Constant checking and correcting of all faults is essential. Faults shall be corrected immediately after they occur.

Common faults are the same as executing paces forward.

On the command ONE PACE(S) STEP BACK—MARCH, combine the two movements, observing the following timing:

1. one pace, one-two;
2. two paces, one, one-two; and
3. three paces, one, one, one-two.



Practice the movement with:

- the **instructor** calling the time;
- the **squad** calling the time; and
- the squad **judging** the time.

Emphasize any movements with which the cadets had difficulty during the lesson.

CONFIRMATION OF TEACHING POINT 2

The cadets' executing paces to the rear will serve as the confirmation of this TP.

END OF LESSON CONFIRMATION

The cadets' executing paces forward and to the rear will serve as the confirmation of this lesson.

CONCLUSION

HOMEWORK / READING / PRACTICE

Nil.

METHOD OF EVALUATION

Nil.

CLOSING STATEMENT

Drill develops and reinforces in cadets many qualities such as patience and determination through self-discipline and practice. Drill requires that cadets move together as one, which promotes discipline, alertness, precision, pride, steadiness and cohesion, and helps develop teamwork.

INSTRUCTOR NOTES / REMARKS

It is recommended that ongoing feedback be provided to the cadets during drill practices, parade nights and ceremonial parades. All corrections shall be made immediately so that bad habits do not persist.

REFERENCES

A0-002 A-DH-201-000/PT-001 Director History and Heritage 3-2. (2006). *The Canadian Forces manual of drill and ceremonial*. Ottawa, ON: Department of National Defence.



COMMON TRAINING
GREEN STAR
INSTRUCTIONAL GUIDE



SECTION 6

EO M108.06 – EXECUTE THE MOVEMENTS REQUIRED FOR A RIGHT DRESS

Total Time:

30 min

PREPARATION

PRE-LESSON INSTRUCTIONS

Resources needed for the delivery of this lesson are listed in the lesson specification located in A-CR-CCP-701/PF-001, *Green Star Qualification Standard and Plan*, Chapter 4. Specific uses for said resources are identified throughout the instructional guide within the TP for which they are required.

Review the lesson content and become familiar with the material prior to delivering the lesson.

PRE-LESSON ASSIGNMENT

Nil.

APPROACH

A demonstration and performance was chosen for this lesson as it allows the instructor to explain and demonstrate the skill the cadets are expected to acquire while providing an opportunity for the cadets to practice the skill under supervision.

INTRODUCTION

REVIEW

Review the drill movements from EO M108.05 (Execute Paces Forward and to the Rear).

OBJECTIVES

By the end of this lesson the cadet shall have executed the movements required for a right dress.

IMPORTANCE

It is important for cadets to be able to perform drill movements at a competent level, developing sharpness, esprit-de-corps, physical coordination and alertness. These movements should be executed with ease ensuring that the cadets move together as one, which promotes discipline, alertness, precision, pride, steadiness and cohesion, and helps develop teamwork.



Develop and use a vocabulary of short, concise words to impress on the cadets that the movements must be performed smartly. For example, the words "crack", "drive", "seize" and "grasp" suggest the degree of smartness required. Profanity or personal sarcasm shall never be used.

Proper drill movements shall be combined with a professional demeanour throughout this lesson.



This lesson is broken down into movements. Explain, demonstrate and allow time for the cadets to practice, in a variety of positions.



Capitalization indicates the words of command for each movement.

Cadence is to be maintained when completing movements.



The term squad is a generic name for a group of cadets, used to teach drill movements. This term can be interchanged with platoon, flight, division or any other applicable elemental or regimental term.



Assistant instructors may be required for this lesson.

Teaching Point 1

Explain, demonstrate and have the cadets execute right dress.

Time: 15 min

Method: Demonstration and Performance



Right Marker. The individual on the right hand side of the front rank.

RIGHT DRESS

Dressing of a squad is required to ensure a uniform, organized appearance when in a formed body. The most common movement used to dress a squad is the right dress.

On the command RIGHT DRESS BY NUMBERS, SQUAD—ONE, the right marker stands fast; and the remainder shoots the left foot forward one half pace, bends the right knee and adopts the position of attention.



Practice the movements with:

- the **instructor** calling the time;
- the **squad** calling the time; and
- the squad **judging** the time.



Constant checking and correcting of all faults is essential. Faults shall be corrected immediately after they occur.

Common faults include:

- incorrect pace size,
- arms not held straight and firmly to the sides,
- wrong foot moved,
- foot is lifted instead of bending the knee, and
- lower leg and foot hanging at an unnatural angle.

On the command SQUAD—TWO, the right file stands fast and the remainder turn their head and eyes to the right as far as possible without straining. Simultaneously, the front rank, except the right marker, shoots the right arm its full extent behind the shoulder of the cadet on the right. The hand is closed as in the position of attention, back of the hand uppermost and arm parallel to the ground.



Practice the movements with:

- the **instructor** calling the time;
- the **squad** calling the time; and
- the squad **judging** the time.



Constant checking and correcting of all faults is essential. Faults shall be corrected immediately after they occur.

Common faults include:

- arm not parallel to the ground,
- centre or rear rank raise arms,
- body is twisted, and
- looking in the wrong direction.

On the command SQUAD—THREE, the right marker stands fast; and the remainder take up correct alignment, distance and covering by taking short, quick paces until they are in position. Movement starts with the left foot.

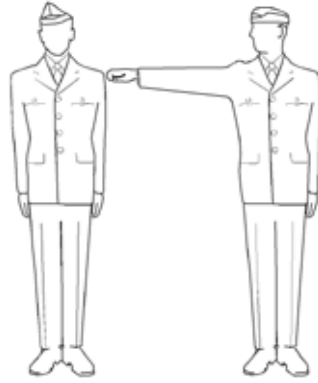

Note. From The Canadian Forces Manual of Drill and Ceremonial (p. 2-19), by Director of History and Heritage 3-2, 2006, Ottawa, ON: Department of National Defence.

Figure 1 Arm Interval-Right Dress



Practice the movements with:

- the **instructor** calling the time;
- the **squad** calling the time; and
- the squad **judging** the time.



Constant checking and correcting of all faults is essential. Faults shall be corrected immediately after they occur.

Common faults include:

- arm striking next person, and
- hand slapping the side of the leg.

On the command RIGHT—DRESS, the three movements are combined, observing the standard pause between the movements. The timing is one-two, pause, arms, pause, move.

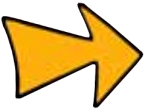

Standard Pause: The standard pause between each movement is two beats in quick time.



When dressing by the left, the same drill is followed except the head and eyes are turned left and the left arm is raised. The left marker stands fast, looks to the front, and those in the file behind adopt the appropriate distance between ranks.



Dressing may be ordered by the centre if more than one squad is on parade in line or mass. The command is INWARD—DRESS, and flanking squads shall dress by their left or right as appropriate.



When a squad is formed with only one person in the blank file, that individual shall dress with the front rank when the squad is advancing and with the rear rank when the squad is retiring. When the squad is moving to a flank, the individual shall dress with the directing flank.



Practice the movement with:

- the **instructor** calling the time;
- the **squad** calling the time; and
- the squad **judging** the time.

Emphasize any movements with which the cadets had difficulty during the TP.

CONFIRMATION OF TEACHING POINT 1

The cadets' executing right dress will serve as the confirmation of this TP.

Teaching Point 2

Explain, demonstrate and have the cadets execute eyes front.

Time: 5 min

Method: Demonstration and Performance

EXECUTE EYES FRONT

On the command EYES—FRONT, the cadets shall snap their head and eyes to the front and cut the right arm to the rear of the individual on the right and to the position of attention without slapping the thigh.



Practice the movements with:

- the **instructor** calling the time;
- the **squad** calling the time; and
- the squad **judging** the time.

CONFIRMATION OF TEACHING POINT 2

The cadets' executing eyes front will serve as the confirmation of this TP.

Teaching Point 3

Explain, demonstrate and have the cadets execute shoulder dressing.

Time: 5 min

Method: Demonstration and Performance

On the command SHOULDER DRESSING, RIGHT—DRESS, the movements are the same as for right dress, except that the arms are not raised and dressing is taken up without arm's length interval. Enough lateral space is left between the shoulders of each person in the rank to complete any movements that may follow the dressing.



Practice the movements with:

- the **instructor** calling the time;
- the **squad** calling the time; and
- the squad **judging** the time.



Constant checking and correcting of all faults is essential. Faults shall be corrected immediately after they occur.

Common faults are the same as right dress except that the arm is not raised.

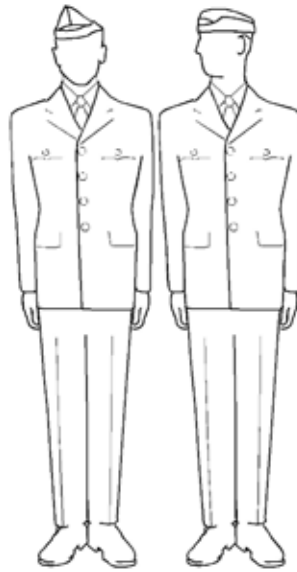

Note. From The Canadian Forces Manual of Drill and Ceremonial (p. 2-19), by Director of History and Heritage 3-2, 2006, Ottawa, ON: Department of National Defence.

Figure 2 Shoulder Dressing

CONFIRMATION OF TEACHING POINT 3

The cadets' executing a shoulder dressing will serve as the confirmation of this TP.

Teaching Point 4

Explain, demonstrate and have the cadets execute elbow dressing.

Time: 5 min

Method: Demonstration and Performance

On the command ELBOW DRESSING, RIGHT—DRESS, the movements are the same as the right dress except, the right hand is placed on the hip or jacket belt as applicable. The fingers are closed, pointed down and extended forward with thumbs to the rear and the point of the elbow is forced forward and touching the cadet's arm on the right.

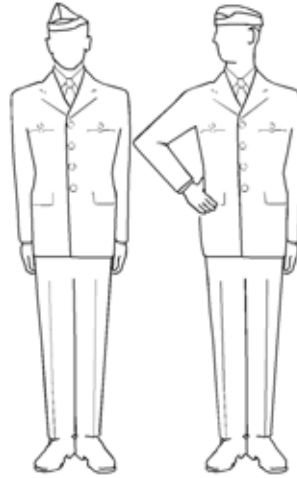

Note. From The Canadian Forces Manual of Drill and Ceremonial (p. 2-19), by Director of History and Heritage 3-2, 2006, Ottawa, ON: Department of National Defence.

Figure 3 Elbow Dressing



Practice the movements with:

- the **instructor** calling the time;
- the **squad** calling the time; and
- the squad **judging** the time.



Constant checking and correcting of all faults is essential. Faults shall be corrected immediately after they occur.

Common faults are the same as dressing at arm's length and also include bending the wrist and hand not on hip.

END OF LESSON CONFIRMATION

The cadets' executing movements required for the right dress will serve as the confirmation of this lesson.

CONCLUSION

HOMework / READING / PRACTICE

Nil.

METHOD OF EVALUATION

Nil.

CLOSING STATEMENT

Drill develops and reinforces in cadets many qualities such as patience and determination through self-discipline and practice. Drill requires that cadets move together as one, which promotes discipline, alertness, precision, pride, steadiness and cohesion, and helps develop teamwork.

INSTRUCTOR NOTES / REMARKS

It is recommended that ongoing feedback be provided to the cadets during drill practices, parade nights and ceremonial parades. All corrections shall be made immediately so that bad habits do not persist.

REFERENCES

A0-002 A-DH-201-000/PT-001 Director History and Heritage 3-2. (2006). *The Canadian Forces manual of drill and ceremonial*. Ottawa, ON: Department of National Defence.



**COMMON TRAINING
GREEN STAR
INSTRUCTIONAL GUIDE**



SECTION 7

EO M108.07 – EXECUTE AN OPEN ORDER AND CLOSE ORDER MARCH

Total Time:

30 min

PREPARATION

PRE-LESSON INSTRUCTIONS

Resources needed for the delivery of this lesson are listed in the lesson specification located in A-CR-CCP-701/PF-001, *Green Star One Qualification Standard and Plan*, Chapter 4. Specific uses for said resources are identified throughout the instructional guide within the TP for which they are required.

Review the lesson content and become familiar with the material prior to delivering the lesson.

PRE-LESSON ASSIGNMENT

Nil.

APPROACH

A demonstration and performance was chosen for this lesson as it allows the instructor to explain and demonstrate the skill the cadet is expected to acquire while providing an opportunity for the cadets to practice the skill under supervision.

INTRODUCTION

REVIEW

Review the drill movements from EO M108.06 (Execute the Movements Required for a Right Dress).

OBJECTIVES

By the end of this lesson the cadet shall have executed an open order and close order march.

IMPORTANCE

It is important for cadets to be able to perform drill movements at a competent level, developing sharpness, esprit-de-corps, physical coordination and alertness. These movements should be executed with ease ensuring that the cadets efficiently moving together as one will promote discipline, alertness, precision, pride, steadiness and cohesion.



Develop and use a vocabulary of short, concise words to impress on the cadets that the movements must be performed smartly. For example, the words "crack", "drive", "seize" and "grasp" suggest the degree of smartness required. Profanity or personal sarcasm shall never be used.

Proper drill movements shall be combined with a professional demeanour throughout this lesson.



This lesson is broken down into movements. Explain, demonstrate and allow time for the cadets to practice, in a variety of positions.



Capitalization indicates the words of command for each movement.

Cadence is to be maintained when completing movements.



The term squad is a generic name for a group of cadets, used to teach drill movements. This term can be interchanged with platoon, flight, division or any other applicable elemental or regimental term.



Assistant instructors may be required for this lesson.

Teaching Point 1

Explain, demonstrate and have the cadets execute an open order march.

Time: 15 min

Method: Demonstration and Performance

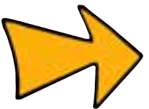

The standard length of a half pace is 35 cm.

OPEN ORDER MARCH

When in a formed body, cadets are inspected at the open order. To adopt this formation, cadets are required to execute an open order march.

The cadet shall execute the open order march, to include:

1. the front rank moving forward three half paces;
2. the rear rank stepping back three half paces; and
3. the centre rank standing fast.



Note. From The Canadian Forces Manual of Drill and Ceremonial (p. 2-22), by Director of History and Heritage 3-2, 2006, Ottawa, ON: Department of National Defence.

Figure 1 Open Order March in Three Ranks

When formed in two ranks, the front rank stands fast and the rear rank steps back three half paces.



Note. From The Canadian Forces Manual of Drill and Ceremonial (p. 2-23), by Director of History and Heritage 3-2, 2006, Ottawa, ON: Department of National Defence.

Figure 2 Open Order March in Two Ranks

On the command OPEN ORDER–MARCH, the movements shall be executed as for three check paces forward and to the rear, the final movement being executed by:

1. bending the right knee, straightening it in double time and placing the right foot smartly on the ground by the left; and
2. assuming the position of attention.



Practice the movements with:

- the **instructor** calling the time;
- the **squad** calling the time; and
- the squad **judging** the time.



Constant checking and correcting of all faults is essential. Faults shall be corrected immediately after they occur.

Common faults include:

- taking paces that are too large while moving forward;
- taking paces that are too small while moving back;
- raising the knee while stepping to the front or to the rear; and
- moving in the centre rank.

The cadence shall be in quick time, and the arms shall be kept still at the sides.

The timing for the movements are counted as ONE, ONE, ONE-TWO.

CONFIRMATION OF TEACHING POINT 1

The cadets' executing an open order march will serve as the confirmation of this TP.

Teaching Point 2

Explain, demonstrate and have the cadets a close order march.

Time: 10 min

Method: Demonstration and Performance

CLOSE ORDER MARCH

The cadet shall execute the close order march, to include:

1. the front rank stepping back three half paces;
2. the rear rank moving forward three half paces; and
3. the centre rank standing fast.

On the command CLOSE ORDER – MARCH, the movements will be executed as for three check paces forward and to the rear, the final movement being executed by:

1. bending the right knee, straightening it in double time and placing the right foot smartly on the ground by the left; and
2. assuming the position of attention.



Practice the movements with:

- the **instructor** calling the time;
- the **squad** calling the time; and
- the squad **judging** the time.



Constant checking and correcting of all faults is essential. Faults shall be corrected immediately after they occur.

Common faults are the same as the open order march.

The cadence shall be in quick time, and the arms shall be kept still at the sides.

The timing for the movements are counted as ONE, ONE, ONE-TWO.



When formed in two ranks, the front rank stands fast and the rear rank moves forward three half paces.



Practice the movements with:

- the **instructor** calling the time;
- the **squad** calling the time; and
- the squad **judging** the time.

Have the cadets practice as a member of the front, rear and centre ranks.

CONFIRMATION OF TEACHING POINT 2

The cadets' executing a close order march will serve as the confirmation of this TP.

END OF LESSON CONFIRMATION

The cadets' executing an open order and close order march will serve as the confirmation of this lesson.

CONCLUSION

HOMework / READING / PRACTICE

Nil.

METHOD OF EVALUATION

Nil.

CLOSING STATEMENT

Drill develops many qualities such as patience and determination through self-discipline and practice. Drill requires that cadets move together as one, which promotes discipline, alertness, precision, pride, steadiness and cohesion, and helps develop teamwork.

INSTRUCTOR NOTES / REMARKS

It is recommended that ongoing feedback be provided to the cadets during drill practices, parade nights and ceremonial parades.

REFERENCES

A0-002 A-DH-201-000/PT-001 Director History and Heritage 3-2. (2006). *The Canadian Forces manual of drill and ceremonial*. Ottawa, ON: Department of National Defence.

THIS PAGE INTENTIONALLY LEFT BLANK



**COMMON TRAINING
GREEN STAR
INSTRUCTIONAL GUIDE**



SECTION 8

EO M108.08 – MARCH AND HALT IN QUICK TIME

Total Time:

30 min

PREPARATION

PRE-LESSON INSTRUCTIONS

Resources needed for the delivery of this lesson are listed in the lesson specification located in A-CR-CCP-701/PF-001, *Green Star Qualification Standard and Plan*, Chapter 4. Specific uses for said resources are identified throughout the instructional guide within the TP for which they are required.

Review the lesson content and become familiar with the material prior to delivering the lesson.

PRE-LESSON ASSIGNMENT

Nil.

APPROACH

A demonstration and performance was chosen for this lesson as it allows the instructor to explain and demonstrate the skill the cadet is expected to acquire while providing an opportunity for the cadets to practice the skill under supervision.

INTRODUCTION

REVIEW

Review the drill movements from EO M108.07 (Execute an Open Order and Close Order March).

OBJECTIVES

By the end of this lesson the cadet shall have marched and halted in quick time.

IMPORTANCE

It is important for cadets to be able to perform drill movements at a competent level, developing sharpness, esprit-de-corps, physical coordination and alertness. These movements should be executed with ease ensuring that the cadets efficiently moving together as one will promote discipline, alertness, precision, pride, steadiness and cohesion.



Develop and use a vocabulary of short, concise words to impress on the cadets that the movements must be performed smartly. For example, the words "crack", "drive", "seize" and "grasp" suggest the degree of smartness required. Profanity or personal sarcasm shall never be used.

Proper drill movements shall be combined with a professional demeanour throughout this lesson.



This lesson is broken down into movements. Explain, demonstrate and allow time for the cadets to practice, in a variety of positions.



Capitalization indicates the words of command for each movement.

Cadence is to be maintained when completing movements.



The term squad is a generic name for a group of cadets, used to teach drill movements. This term can be interchanged with platoon, flight, division or any other applicable elemental or regimental term.



Assistant instructors may be required for this lesson.

Teaching Point 1

Explain, demonstrate and have the cadets march in quick time.

Time: 10 min

Method: Demonstration and Performance



The standard length of a pace is 75 cm.

MARCH IN QUICK TIME

Corps / Squadrons march and manoeuvre on foot in quick, slow, and double time. When marching in quick time, the cadence is set at 120 paces per minute.



The quick march can be maintained for long periods of time and is the standard for routine duty.

On the command QUICK MARCH BY NUMBERS, SQUAD—ONE, the cadet shall shoot the left foot forward one half pace, toe up; strike the heel on the ground first and keep the toe pointed directly forward; and simultaneously, swing the right arm straight forward and the left arm straight to the rear, waist high.



Practice the movements with:

- the **instructor** calling the time;
- the **squad** calling the time; and
- the squad **judging** the time.



Constant checking and correcting of all faults is essential. Faults shall be corrected immediately after they occur.

Common faults include:

- taking a pace greater than 35 cm (one half pace);
- placing or slapping the left foot flat on the ground instead of striking the heel first; and
- swinging the arms at an incorrect height.

On the command SQUAD—TWO, the cadets shall continue to march with subsequent paces of standard length; bringing the legs forward successively in a straight line; swinging the arms forward successively in a straight line from the shoulder, front to rear, with hands closed as in the position of attention; and maintaining dressing by the directing flank.



The directing flank is the rank or file assigned by the commander as that from which the dressing is to be taken, when formed as a squad.



Practice the movements with:

- the **instructor** calling the time;
- the **squad** calling the time; and
- the squad **judging** the time.



Constant checking and correcting of all faults is essential. Faults shall be corrected immediately after they occur.

Common faults are the same as for the initial pace except the pace is greater or less than 75 cm.

On the command QUICK—MARCH, combine the two movements. The timing will be “LEFT—RIGHT—LEFT”

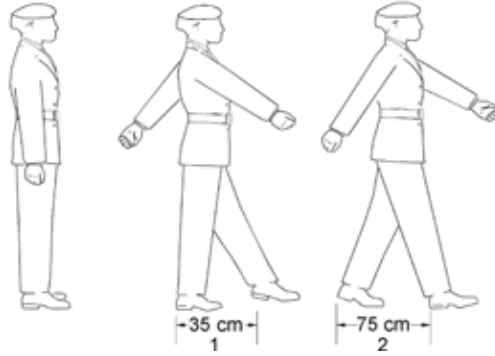

Note. From The Canadian Forces Manual of Drill and Ceremonial (p. 3-6), by Director of History and Heritage 3-2, 2006, Ottawa, ON: Department of National Defence.

Figure 1 Marching in Quick Time

CONFIRMATION OF TEACHING POINT 1

The cadets' marching in quick time will serve as the confirmation of this TP.

Teaching Point 2

Explain, demonstrate and have the cadets halt in quick time.

Time: 10 min

Method: Demonstration and Performance

HALT IN QUICK TIME

On the command HALT BY NUMBERS, SQUAD—ONE, given as the left foot is forward and on the ground, the cadet shall check the forward movement by placing the right foot flat on the ground, use the heel as a brake; and swing the left arm forward and the right arm to the rear.



Practice the movements with:

- the **instructor** calling the time;
- the **squad** calling the time; and
- the squad **judging** the time.



Constant checking and correcting of all faults is essential. Faults shall be corrected immediately after they occur.

Common faults include taking a pace larger or smaller than 75 cm; and not swinging the arms to the front and rear.

On the command SQUAD—TWO, the cadet shall take a half pace with the left foot, place it flat on the ground; and swing the right arm forward and the left to the rear.



Practice the movements with:

- the **instructor** calling the time;
- the **squad** calling the time; and
- the squad **judging** the time.



Constant checking and correcting of all faults is essential. Faults shall be corrected immediately after they occur.

Common faults are the same as the initial pace except taking a pace larger than 35 cm (one half pace).

On the command SQUAD—THREE, the cadet shall bend the right knee, straighten it in double time; and simultaneously, cut the arms to the side and assume the position of attention.



Practice the movements with:

- the **instructor** calling the time;
- the **squad** calling the time; and
- the squad **judging** the time.



Constant checking and correcting of all faults is essential. Faults shall be corrected immediately after they occur.

Common faults include not cutting the arms to the side; and not bending the right knee and straightening in double time.

On the command SQUAD—HALT, combine the three movements in quick time. The timing for the movements is counted as ONE, ONE, ONE-TWO.



Practice the movements with:

- the **instructor** calling the time;
- the **squad** calling the time; and
- the squad **judging** the time.

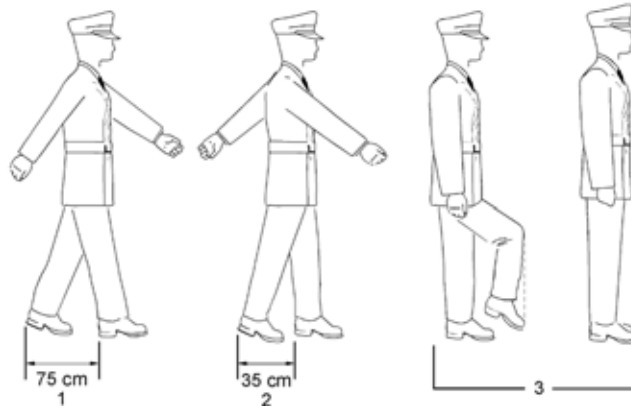

Note. From The Canadian Forces Manual of Drill and Ceremonial (p. 3-3), by Director of History and Heritage 3-2, 2006, Ottawa, ON: Department of National Defence.

Figure 2 Halting in Quick Time

CONFIRMATION OF TEACHING POINT 2

The cadets' halting in quick time will serve as the confirmation of this TP.

END OF LESSON CONFIRMATION

The cadets' marching and halting in quick time will serve as the confirmation of this lesson.

CONCLUSION

HOMEWORK / READING / PRACTICE

Nil.

METHOD OF EVALUATION

Nil.

CLOSING STATEMENT

Drill develops many qualities such as patience and determination through self-discipline and practice. Drill requires that cadets move together as one, which promotes discipline, alertness, precision, pride, steadiness and cohesion, and helps develop teamwork.

INSTRUCTOR NOTES / REMARKS

It is recommended that ongoing feedback be provided to the cadets during drill practices, parade nights and ceremonial parades.

REFERENCES

A0-002 A-DH-201-000/PT-001 Director History and Heritage 3-2. (2006). *The Canadian Forces manual of drill and ceremonial*. Ottawa, ON: Department of National Defence.

THIS PAGE INTENTIONALLY LEFT BLANK



**COMMON TRAINING
GREEN STAR
INSTRUCTIONAL GUIDE**



SECTION 9

EO M108.09 – EXECUTE MARKING TIME, FORWARD AND HALTING IN QUICK TIME

Total Time:

30 min

PREPARATION

PRE-LESSON INSTRUCTIONS

Resources needed for the delivery of this lesson are listed in the lesson specification located in A-CR-CCP-701/PF-001, *Green Star Qualification Standard and Plan*, Chapter 4. Specific uses for said resources are identified throughout the instructional guide within the TP for which they are required.

Review the lesson content and become familiar with the material prior to delivering the lesson.

PRE-LESSON ASSIGNMENT

Nil.

APPROACH

A demonstration and performance was chosen for this lesson as it allows the instructor to explain and demonstrate the skill the cadet is expected to acquire while providing an opportunity for the cadets to practice the skill under supervision.

INTRODUCTION

REVIEW

Review the drill movements from EO M108.08 (March and Halt in Quick Time).

OBJECTIVES

By the end of this lesson the cadet shall have executed marking time, forward and halting in quick time.

IMPORTANCE

It is important for cadets to be able to perform drill movements at a competent level, developing sharpness, esprit-de-corps, physical coordination and alertness. These movements should be executed with ease ensuring that the cadets efficiently moving together as one will promote discipline, alertness, precision, pride, steadiness and cohesion.



Develop and use a vocabulary of short, concise words to impress on the cadets that the movements must be performed smartly. For example, the words "crack", "drive", "seize" and "grasp" suggest the degree of smartness required. Profanity or personal sarcasm shall never be used.

Proper drill movements shall be combined with a professional demeanour throughout this lesson.



This lesson is broken down into movements. Explain, demonstrate and allow time for the cadets to practice, in a variety of positions.



Capitalization indicates the words of command for each movement.

Cadence is to be maintained when completing movements.



The term squad is a generic name for a group of cadets, used to teach drill movements. This term can be interchanged with platoon, flight, division or any other applicable elemental or regimental term.



Assistant instructors may be required for this lesson.

Teaching Point 1

Explain, demonstrate and have the cadets march in quick time.

Time: 10 min

Method: Demonstration and Performance

MARK TIME



Marking time is executed when ceasing forward motion for a short period of time, while on the march. Marking time is carried out at the same cadence as for marching. Only the legs are moved and the upper portion of the body remains in the position of attention with arms at the side.



The command for mark time is given as the right foot is forward on the ground.

On the command MARK TIME BY NUMBERS, SQUAD—ONE, the cadet shall take a half pace with the left foot, placing the foot flat on the ground naturally. Maintaining the same cadence, bring the right foot into the left in a straight leg manner, not scraping the ground; and simultaneously, cut the arms to the sides and assuming the position of attention.



Practice the movements with:

- the **instructor** calling the time;
- the **squad** calling the time; and
- the squad **judging** the time.



Constant checking and correcting of all faults is essential. Faults shall be corrected immediately after they occur.

Common faults include:

- taking a pace larger than 35 cm (one half pace); and
- scraping the right foot on the ground as it is being brought into the left.

On the command SQUAD—TWO the cadet shall bend the left knee so that the lower leg and foot are allowed to hang at a natural angle and the toe is 15 cm above the ground; place the toe on the ground before the heel as the leg is lowered; and continuing to mark time until the command FOR—WARD or HALT is given.



Practice the movements with:

- the **instructor** calling the time;
- the **squad** calling the time; and
- the squad **judging** the time.



Constant checking and correcting of all faults is essential. Faults shall be corrected immediately after they occur.

Common faults include:

- not holding the arms straight and firmly to the sides;
- swaying side to side;
- quickening the pace; and
- not maintaining dressing.

On the command MARK – TIME, combine the two movements. The timing is “left—in—left—right—left”.



Practice the movements with:

- the **instructor** calling the time;
- the **squad** calling the time; and
- the squad **judging** the time.

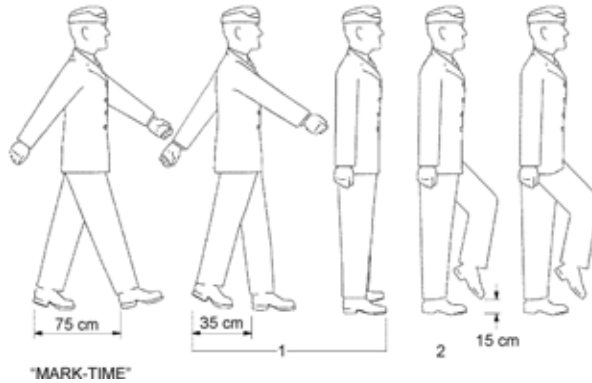

Note. From The Canadian Forces Manual of Drill and Ceremonial (p. 3-16), by Director of History and Heritage 3-2, 2006, Ottawa, ON: Department of National Defence.

Figure 1 Marking Time in Quick Time

CONFIRMATION OF TEACHING POINT 1

The cadets' marking time will serve as the confirmation of this TP.

Teaching Point 2

Explain, demonstrate and have the cadets execute forward from marking time.

Time: 10 min

Method: Demonstration and Performance

FORWARD FROM MARKING TIME



The command for Forward is given as the left foot is on the ground.

This movement is not taught broken down as it is best learned as a complete movement.

On the command FOR—WARD, the cadet shall straighten the right leg and assume the position of attention; shoot the left foot forward in a half pace; and continue to march in quick time, swinging the right arm forward and the left to the rear.

On the command MARK – TIME, combine the two movements. Utilize the timing: “left – in – left – right – left”.



Practice the movements with:

- the **instructor** calling the time;
- the **squad** calling the time; and
- the squad **judging** the time.



Constant checking and correcting of all faults is essential. Faults shall be corrected immediately after they occur.

Common faults include:

- arms not held straight and firmly to the sides;
- not stepping off with the rest of the squad;
- stepping off on the wrong foot; and
- initial pace larger than one half pace.

CONFIRMATION OF TEACHING POINT 2

The cadets' executing forward from marking time will serve as the confirmation of this TP.

Teaching Point 3

Explain, demonstrate and have the cadets execute halting in quick time from marking time.

Time: 5 min

Method: Demonstration and Performance

HALTING IN QUICK TIME FROM MARKING TIME



The command is given as the left foot is on the ground.

This movement is not taught broken down as it is best learned as a complete movement.

On the command SQUAD – HALT, the cadet shall

1. take a further mark time pace with the right foot;
2. take a further mark time pace with the left foot; and
3. straighten the right leg in double time and assume the position of attention.

The timing is “one, one-two”.

On the command MARK – TIME, combine the two movements. Utilize the timing: “left – in – left – right – left”.



Practice the movements with:

- the **instructor** calling the time;
- the **squad** calling the time; and
- the squad **judging** the time.



Constant checking and correcting of all faults is essential. Faults shall be corrected immediately after they occur.

Common faults include not halting at the same time as the rest of the squad.

END OF LESSON CONFIRMATION

The cadets' executing marking time, forward and halting in quick time will serve as the confirmation of this lesson.

CONCLUSION

HOMEWORK / READING / PRACTICE

Nil.

METHOD OF EVALUATION

Nil.

CLOSING STATEMENT

Drill develops many qualities such as patience and determination through self-discipline and practice. Drill requires that cadets move together as one, which promotes discipline, alertness, precision, pride, steadiness and cohesion, and helps develop teamwork.

INSTRUCTOR NOTES / REMARKS

It is recommended that ongoing feedback be provided to the cadets during drill practices, parade nights and ceremonial parades.

REFERENCES

A0-002 A-PH-201-000/PT-001 Director History and Heritage 3-2. (2006). *The Canadian Forces manual of drill and ceremonial*. Ottawa, ON: Department of National Defence.



**COMMON TRAINING
GREEN STAR
INSTRUCTIONAL GUIDE**



SECTION 10

EO M108.10 – EXECUTE A SALUTE ON THE MARCH

Total Time:

30 min

PREPARATION

PRE-LESSON INSTRUCTIONS

Resources needed for the delivery of this lesson are listed in the lesson specification located in A-CR-CCP-701/PF-001, *Green Star Qualification Standard and Plan*, Chapter 4. Specific uses for said resources are identified throughout the instructional guide within the TP for which they are required.

Review the lesson content and become familiar with the material prior to delivering the lesson.

PRE-LESSON ASSIGNMENT

Nil.

APPROACH

A demonstration and performance was chosen for this lesson as it allows the instructor to explain and demonstrate the skill the cadet is expected to acquire while providing an opportunity for the cadets to practice the skill under supervision.

INTRODUCTION

REVIEW

Review the drill movements from EO M108.02 (Execute a Salute at the Halt Without Arms).

OBJECTIVES

By the end of this lesson the cadet shall have saluted on the march.

IMPORTANCE

It is important for cadets to be able to perform drill movements at a competent level, developing sharpness, esprit-de-corps, physical coordination and alertness. These movements should be executed with ease ensuring that the cadets efficiently moving together as one will promote discipline, alertness, precision, pride, steadiness and cohesion.



Develop and use a vocabulary of short, concise words to impress on the cadets that the movements must be performed smartly. For example, the words "crack", "drive", "seize" and "grasp" suggest the degree of smartness required. Profanity or personal sarcasm shall never be used.

Proper drill movements shall be combined with a professional demeanour throughout this lesson.



This lesson is broken down into movements. Explain, demonstrate and allow time for the cadets to practice, in a variety of positions.



Capitalization indicates the words of command for each movement.

Cadence is to be maintained when completing movements.



The term squad is a generic name for a group of cadets, used to teach drill movements. This term can be interchanged with platoon, flight, division or any other applicable elemental or regimental term.



Assistant instructors may be required for this lesson.

Teaching Point 1

Execute saluting on the march.

Time: 15 min

Method: Demonstration and Performance

DEMONSTRATE THE COMPLETE MOVEMENT WITH TIMING



Instructors are reminded that they are to present the example with regards to drill, from the moment they step onto the parade square. Proper drill movements, combined with a professional demeanour, are of paramount importance, and must be exemplified throughout the period of instruction.

The instructor shall provide a complete demonstration of the drill movement, with timing. A practiced assistant instructor may carry out this demonstration.

The demonstration shall be provided from various vantage points, as required.

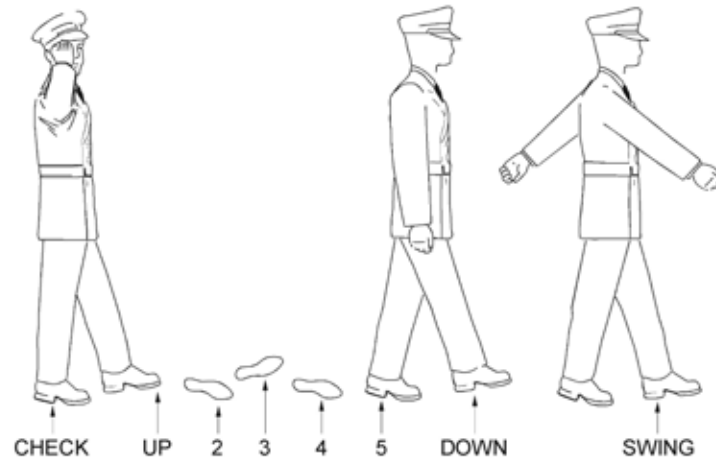

A-PD-201-000/PT-000 *The Canadian Forces Manual of Drill and Ceremonial, 2001*

Figure 1 Saluting on the March

DEMONSTRATE FIRST PART OF MOVEMENT (FIRST NUMBER)



For ease of instruction, drill commands have been broken down into individual movements, or numbers. The instructor(s) shall demonstrate and explain each number.

On the command TO THE RIGHT (LEFT) SALUTE BY NUMBERS, SQUAD – ONE, given as the left foot is forward and on the ground, the cadet shall execute the first number by:

1. completing the next pace with the right foot; and
2. swinging the left arm forward and the right arm to the rear normally.

PRACTISE THE SQUAD ON THE FIRST MOVEMENT

Practise the squad on the first movement collectively, individually and collectively



Constant checking and correcting of all faults is essential. Faults shall be corrected immediately after they occur.

DEMONSTRATE AND EXPLAIN THE SECOND PART OF THE MOVEMENT (SECOND NUMBER)

On the command SQUAD – TWO the cadet shall execute the second number by:

1. completing the next pace with the left foot;
2. cutting the left arm to the side; and
3. cutting the right arm forward to the side and then up into the salute in one continuous movement.

PRACTISE THE SQUAD ON THE SECOND MOVEMENT

Practise the squad on the second movement collectively, individually and collectively.

DEMONSTRATE AND EXPLAIN THE THIRD PART OF THE MOVEMENT (THIRD NUMBER)

On the command SQUAD – THREE, the cadet shall complete four paces in quick time, ending with the left foot forward.

PRACTISE THE SQUAD ON THE THIRD MOVEMENT

Practise the squad on the third movement collectively, individually and collectively.

DEMONSTRATE AND EXPLAIN THE FOURTH PART OF THE MOVEMENT (FOURTH NUMBER)

On the command SQUAD – FOUR, the cadet shall execute the fourth number by:

1. completing a pace with the right foot; and
2. cutting the right arm to the side.

PRACTISE THE SQUAD ON THE FOURTH MOVEMENT

Practise the squad on the fourth movement collectively, individually and collectively.

DEMONSTRATE AND EXPLAIN THE FIFTH PART OF THE MOVEMENT (FIFTH NUMBER)

On the command SQUAD – FIVE, the cadet shall continue to march.

PRACTISE THE SQUAD ON THE FIFTH MOVEMENT

Practise the squad on the fifth movement collectively, individually and collectively.

GIVE TWO COMPLETE AND FINAL DEMONSTRATIONS

On the command TO THE RIGHT (LEFT) – SALUTE, the movements and combined, and the timing, “check – up – two – three – four– five – down – swing”, is utilized.

The instructor(s) shall provide a full demonstration and allow time for practice.

Teaching Point 2

Practise saluting on the march.

Time: 10 min

Method: Demonstration and Performance



While saluting, the head is turned right (left) as far as possible without straining.

On the command TO THE RIGHT (LEFT) – SALUTE, the movements are combined, and the timing, CHECK – UP – TWO – THREE – FOUR– FIVE – DOWN – SWING, is utilized.



Note: This movement requires much practice as a formed body, and the instructor is encouraged to fully utilize this time for said practice.

END OF LESSON CONFIRMATION

The confirmation for this lesson should consist of the cadets, as a squad, practicing saluting on the march (**right and left**), and should emphasize movements that cadets showed difficulty with during the class.

Practise the complete movement with the:

- **Instructor** calling the time;
- **Squad** calling the time; and
- Squad **judging** the time.

END OF LESSON CONFIRMATION

The cadets' saluting on the march will serve as the confirmation of this lesson.

CONCLUSION

HOMEWORK / READING / PRACTICE

Nil.

METHOD OF EVALUATION

Nil.

CLOSING STATEMENT

Drill develops many qualities such as patience and determination through self-discipline and practice. Drill requires that cadets move together as one, which promotes discipline, alertness, precision, pride, steadiness and cohesion, and helps develop teamwork.

INSTRUCTOR NOTES / REMARKS

It is recommended that ongoing feedback be provided to the cadets during drill practices, parade nights and ceremonial parades.

REFERENCES

A0-002 A-DH-201-000/PT-001 Director History and Heritage 3-2. (2006). *The Canadian Forces manual of drill and ceremonial*. Ottawa, ON: Department of National Defence.

THIS PAGE INTENTIONALLY LEFT BLANK



**COMMON TRAINING
GREEN STAR
INSTRUCTIONAL GUIDE**



SECTION 11

EO M108.11 – PAY COMPLIMENTS WITH A SQUAD ON THE MARCH

Total Time:

30 min

PREPARATION

PRE-LESSON INSTRUCTIONS

Resources needed for the delivery of this lesson are listed in the lesson specification located in A-CR-CCP-701/PG-001, *Green Star Qualification Standard and Plan*, Chapter 4. Specific uses for said resources are identified throughout the instructional guide within the TP for which they are required.

Review the lesson content and become familiar with the material prior to delivering the lesson.

PRE-LESSON ASSIGNMENT

Nil.

APPROACH

A demonstration and performance was chosen for this lesson as it allows the instructor to explain and demonstrate the skill the cadet is expected to acquire while providing an opportunity for the cadets to practice the skill under supervision.

INTRODUCTION

REVIEW

Review the drill movements from EO M108.10 (Execute A Salute on the March).

OBJECTIVES

By the end of this lesson the cadet shall have paid compliments with a squad on the march.

IMPORTANCE

It is important for cadets to be able to perform drill movements at a competent level, developing sharpness, esprit-de-corps, physical coordination and alertness. These movements should be executed with ease ensuring that the cadets efficiently moving together as one will promote discipline, alertness, precision, pride, steadiness and cohesion.



Develop and use a vocabulary of short, concise words to impress on the cadets that the movements must be performed smartly. For example, the words "crack", "drive", "seize" and "grasp" suggest the degree of smartness required. Profanity or personal sarcasm shall never be used.

Proper drill movements shall be combined with a professional demeanour throughout this lesson.



This lesson is broken down into movements. Explain, demonstrate and allow time for the cadets to practice, in a variety of positions.



Capitalization indicates the words of command for each movement.

Cadence is to be maintained when completing movements.



The term squad is a generic name for a group of cadets, used to teach drill movements. This term can be interchanged with platoon, flight, division or any other applicable elemental or regimental term.



Assistant instructors may be required for this lesson.

Teaching Point 1

Explain, demonstrate and have the cadets execute eyes right (left) to pay compliments with a squad on the march.

Time: 15 min

Method: Demonstration and Performance

EYES RIGHT (LEFT) WITH A SQUAD ON THE MARCH



While marching as a member of a squad, do not salute from within the ranks, but turn the head in the direction of the person or object to which compliments are being paid.



The command for paying compliments with a squad on the march is given as the left foot is forward and on the ground.

On the command EYES—RIGHT (LEFT), the cadets shall

1. complete the next pace forward with the right foot;
2. as the left foot comes forward again and strikes the ground, turn the head and eyes to the right (left) as far as possible without straining and look directly into the eyes of the personage being saluted;
3. continue to swing the arms; and
4. maintain dressing, direction, and cadence, while continuing to march.



The leading person on the directing flank shall maintain head and eyes to the front to keep direction.

Directing flank box



The person in command of the squad shall salute.



Practice the movements with:

- the **instructor** calling the time;
- the **squad** calling the time; and
- the squad **judging** the time.



Constant checking and correcting of all faults is essential. Faults shall be corrected immediately after they occur.

Common faults include turning the head and eyes immediately rather than turning the head and eyes after the completion of the next pace forward.

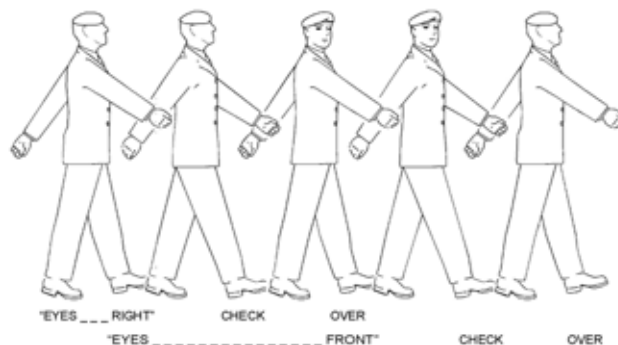

Note. From The Canadian Forces Manual of Drill and Ceremonial (p. 3-25), by Director of History and Heritage 3-2, 2006, Ottawa, ON: Department of National Defence.

Figure 1 Eyes Right on the March

CONFIRMATION OF TEACHING POINT 1

The cadets' executing an eyes right (left) to pay compliments on the march will serve as the confirmation of this TP.

Teaching Point 2

Explain, demonstrate and have the cadets execute eyes front to pay compliments with a squad on the march.

Time: 10 min

Method: Demonstration and Performance

EYES FRONT WITH A SQUAD ON THE MARCH



The command for paying compliments with a squad on the march is given as the left foot is forward and on the ground.

On the command EYES—FRONT, the cadet shall complete the next pace forward with the right foot; and as the left foot comes forward and strikes the ground, cut the head and eyes smartly to the front.



Practice the movements with:

- the **instructor** calling the time;
- the **squad** calling the time; and
- the squad **judging** the time.



Constant checking and correcting of all faults is essential. Faults shall be corrected immediately after they occur.

Common faults include turning the head and eyes immediately rather than turning the head and eyes after the completion of the next pace forward.

CONFIRMATION OF TEACHING POINT 2

The cadets' executing an eyes front to pay compliments on the march will serve as the confirmation of this TP.

END OF LESSON CONFIRMATION

The cadets' executing a salute on the march will serve as the confirmation of this lesson.

CONCLUSION

HOMEWORK / READING / PRACTICE

Nil.

METHOD OF EVALUATION

Nil.

CLOSING STATEMENT

Drill develops many qualities such as patience and determination through self-discipline and practice. Drill requires that cadets move together as one, which promotes discipline, alertness, precision, pride, steadiness and cohesion, and helps develop teamwork.

INSTRUCTOR NOTES / REMARKS

It is recommended that ongoing feedback be provided to the cadets during drill practices, parade nights and ceremonial parades.

REFERENCES

A0-002 A-DH-201-000/PT-001 Director History and Heritage 3-2. (2006). *The Canadian Forces manual of drill and ceremonial*. Ottawa, ON: Department of National Defence.

THIS PAGE INTENTIONALLY LEFT BLANK



**COMMON TRAINING
GREEN STAR
INSTRUCTIONAL GUIDE**



SECTION 12

EO M108.12 – PERFORM DRILL MOVEMENTS DURING AN ANNUAL CEREMONIAL REVIEW

Total Time:

90 min

THERE IS NO INSTRUCTIONAL GUIDE FOR THIS EO.

THIS PAGE INTENTIONALLY LEFT BLANK



**COMMON TRAINING
GREEN STAR
INSTRUCTIONAL GUIDE**



SECTION 13

EO C108.01 – EXECUTE SUPPLEMENTARY DRILL MOVEMENTS

Total Time:

180 min

NO INSTRUCTIONAL GUIDE IS PROVIDED FOR THIS EO.

THIS PAGE INTENTIONALLY LEFT BLANK



**COMMON TRAINING
GREEN STAR
INSTRUCTIONAL GUIDE**



SECTION 14

EO C108.02 – PARTICIPATE IN A DRILL COMPETITION

Total Time:

90 min

PREPARATION

PRE-LESSON INSTRUCTIONS

Resources needed for the delivery of this lesson are listed in the lesson specification located in A-CR-CCP-701/PF-001, *Green Star Qualification Standard and Plan*, Chapter 4. Specific uses for said resources are identified throughout the instructional guide within the TP for which they are required.

Review the lesson content and become familiar with the material prior to delivering the lesson.

Photocopy the Drill Competition Marking Guide located at Attachment C and sufficient copies of the Drill Competition Marking Sheet located at Attachment D for each judge.

PRE-LESSON ASSIGNMENT

Nil.

APPROACH

A practical activity was chosen for this lesson as it is an interactive way to allow the cadets to participate in a drill competition.

INTRODUCTION

REVIEW

Review the drill movements from EO M108.01 to EO M108.11.

OBJECTIVES

By the end of this lesson the cadet shall have participated in a drill competition.

IMPORTANCE

It is important for cadets to be able to perform drill movements at a competent level, developing sharpness, esprit-de-corps, physical coordination and alertness. These movements should be executed with ease ensuring that the cadets efficiently moving together as one will promote discipline, alertness, precision, pride, steadiness and cohesion.

ACTIVITY

Time: 90 min

OBJECTIVE

The objective of this activity is to have the cadets participate in a drill competition.

RESOURCES

- Tables,
- Chairs,
- Masking Tape,
- Stop Watch,
- Portable hand counters (clickers),
- Drill sequence,
- Pens,
- Parade markers, and
- Judges.

ACTIVITY LAYOUT

Set up the drill hall or outdoor parade square with tables and chairs. The drill area will be marked off, to include a restricted-access area large enough to accommodate execution of the marching and wheeling components of the competition with a judge's table placed mid-point along one of the sides of the drill area.

ACTIVITY INSTRUCTIONS

1. Divide the year one cadets into squads not to exceed 10 cadets.
2. Appoint a team captain (Drill Team Commander), at a minimum, a year three cadet in training to direct the team through the drill sequence.
3. Provide each team time to practice as a squad prior to competing. During this practice, the team captain will review all rehearsed movements from PO 108.
4. Have the drill team commander lead the drill team through the entire drill sequence.
5. Without assistance, acting as a drill team in a competition environment, the flight will follow commands and be marked on its performance of the specified drill sequence. Cadets will respectfully observe the performance of other flight drill teams whenever they are not performing.
6. Marking will be performed by the judges using the marking guide located at Attachment C and the marking sheet located at Attachment D. When numerous flights are competing, it is necessary to maximize the use of time. As the flights rotate through the competition, flights waiting to perform or flights that have already performed can be scheduled for other concurrent activities (eg, while one flight is waiting to perform another flight is undergoing uniform inspections).

SAFETY

Nil.



Capitalization indicates the words of command for each movement.
Cadence is to be maintained when completing movements.



The term squad is a generic name for a group of cadets, used to teach drill movements. This term can be interchanged with platoon, flight, division or any other applicable elemental or regimental term.



Assistant instructors may be required for this lesson.

END OF LESSON CONFIRMATION

The cadets' participation in a drill competition will serve as confirmation of this lesson.

CONCLUSION

HOMework / READING / PRACTICE

Nil.

METHOD OF EVALUATION

Nil.

CLOSING STATEMENT

Drill helps a cadet develop many qualities such as patience and determination through self-discipline and practice. Drill requires that cadets move together as one, which promotes discipline, alertness, precision, pride, steadiness and cohesion, and helps develop teamwork.

INSTRUCTOR NOTES / REMARKS

It is recommended that ongoing feedback be provided to the cadets during drill practices, parade nights and ceremonial parades.

REFERENCES

A0-002 A-DH-201-000/PT-001 Director History and Heritage 3-2. (2006). *The Canadian Forces manual of drill and ceremonial*. Ottawa, ON: Department of National Defence.

THIS PAGE INTENTIONALLY LEFT BLANK

GUIDELINES FOR THE CONDUCT OF A YEAR ONE DRILL COMPETITION

OFFICIALS

1. Officials shall be as follows:
 - a. Chief Judge – responsible for:
 - (1) Judging and marking the Team Captain;
 - (2) Awarding penalties; and
 - (3) Interpretation of rules; and
 - b. Drill Judge(s) – responsible for judging and marking the performance of the team during the drill sequence.

DRESS

2. Dress for the competition will be at the discretion of the corps Trg O and IAW CATO 46-01. Uniform C-1 is encouraged, though weather conditions at the time of the competition will be the determining factor.

DRILL SEQUENCE

3. When called to compete, the team (accompanied and directed by the team captain) will march on, with the right marker at the designated point opposite the judges table, dressed at the close order. When the Drill Team Commander reports for inspection, the judging will begin approach the Chief Judge, report the name of the team, and request permission to carry on with the competition.
4. On receiving permission from the Chief Judge, the team captain will then direct the team through the drill movements IAW Attachment B. The squad will be returned to its original position following the completion of the movements. The DTC will then report to the Chief Judge, and request permission to march off.

TIMING

5. A maximum of 15 minutes is allowed for each competing team. The timing will commence immediately following the team captain being granted permission to proceed and will terminate when the team captain reports to the Chief Judge upon completion of the drill sequence.

DRILL AUTHORITY

6. All drill movements will be carried out IAW A-PD-201-000/PT-000 *Canadian Forces Manual of Drill and Ceremonial*.

MARKING

7. Marking will be performed by the judges using the marking guide located at Attachment C and the marking sheet located at Attachment D. One point will be deducted for each individual fault or infraction to a maximum of 80 point deductions. A maximum of five points will be deducted for a single movement (eg, if a whole team performs a movement incorrectly, a total of five points will be deducted).

PENALTIES

8. Penalties will be deducted for specific infractions. Additional points will not be deducted for an infraction for which a penalty is awarded.

9. The following penalties will be awarded for infractions and will be deducted from the drill score by the Chief Judge:
- a. Omission of a drill movement 5 points.
 - b. Drill movement performed out of sequence 1 point.
 - c. Late when called to compete 2 points.
 - d. Exceeding maximum time allowance for sequence 2 points.

INTERPRETATION OF RULES

10. In any situation where no equitable solution can be found in the rules, the Chief Judge will be empowered to make a ruling, which is binding to all participants

DRILL SEQUENCE

STANDING DRILL

1. Stand Easy
2. Stand at Ease
3. Attention
4. To the Front Salute
5. Left Turn
6. Right Turn
7. About Turn
8. Right Incline
9. About Turn
10. Open Order March
11. Right Dress
12. Eyes Front
13. Close Order March
14. Right Turn

MARCHING DRILL

1. Quick March
2. Mark Time
3. Forward
4. Mark Time
5. Halt
6. Quick March
7. Left Wheel
8. Left Wheel
9. Salute to the Right on the March
10. Left Wheel
11. Right Wheel
12. Right Wheel
13. Right Wheel
14. Mark Time
15. Halt

STANDING DRILL

1. Left Turn
2. Right Dress
3. Eyes Front

DRILL COMPETITION MARKING GUIDE

INSPECTION

The inspection will be marked out of five possible points in the following areas:

Beret. Worn on the right side of the head, with the lower point of the front crease in the centre of the forehead and the front edge of the cap 2.5 cm (1 inch) above the right eyebrow.

Male hair. Neatly groomed, taper-trimmed at the back, sides and above the ears with no hair touching the ears or collar. Sideburns shall not extend below a line horizontally bisecting the ear, and shall be squared off horizontally at the bottom edge and taper trimmed to conform to the overall hairstyle. Beards shall not be worn except for those of the Sikh religion.

Female hair. Neatly groomed and not extend below the lower edge of the jacket collar. Bizarre styles or colours are not permitted in uniform. A single braid, if worn, shall be worn in the centre of the back. Double braids, if worn, shall be worn to the back. All multiple braids shall be directed toward the back. Multiple braids, if worn, extending below the lower edge of the collar are to be gathered in a bun. The braid may not extend beyond the armpit. No hair ornaments are to be worn and effort should be made to ensure that bobby pins secure hair and are unobtrusive.

Appearance. Only a wristwatch, medical alert bracelet, and a maximum of two rings may be worn with the uniform (costume rings are not to be worn in uniform). Female cadets may wear a single pair of plain gold, silver stud or white pearl earrings in pierced ears. Makeup shall be applied conservatively. No eyeliner, fake eyelashes, coloured eye shadow or nail polish is to be worn in uniform. Male cadets are not authorized to wear earrings. Covering piercings with a bandage (band-aid) is not acceptable.

Trousers. Pressed with creases down the centre of each leg, and worn with the black belt.

Short-sleeved shirt. Pressed with a crease along the upper edge of each arm. Rank slip-ons shall be worn with the short-sleeved shirt.

Boots. Shined all over, laced across horizontally from side to side, and worn with grey wool socks.

DTC

Reporting. DTC reports to the judges confidently and in the correct manner.

Words of command. The words of command should be correct, called on the correct foot and with the correct interval of timings. They should be clear and loud enough for the entire team to hear and obey.

Ability to control. The ability to command, control and give proper orders to the team carrying out drill movements.

COMPULSORY SEQUENCE

All standing and marching drill for the compulsory sequence will be marked out of a total of five points. One point will be deducted for errors in each of the following areas:

Body drive. The amount of effort put into the movements.

Correctness of movement. This includes immediate and correct response to the command with the standard pause (two beats of quick time) observed where necessary.

Correct dressing. The alignment of ranks and flanks at the halt and on the march.

Steadiness. No excess movements during any portion of the drill sequence, including fidgeting, fixing the uniform, etc.

Precision. Movements are carried out in unison.

THIS PAGE INTENTIONALLY LEFT BLANK

DRILL COMPETITION MARKING SHEET

Team: _____

Date: _____

DTC: _____

Inspection - Maximum 30 Points			
1.	Beret		/5
2.	Hair		/5
3.	Appearance		/5
4.	Trousers		/5
5.	Short-sleeved shirt		/5
6.	Boots		/5
Sub-total			/30
DTC - Maximum 40 Points			
1.	Reporting		/10
2.	Words of Command		/20
3.	Ability to Control		/10
Sub-total			/40
Drill Movements - Maximum Points			
Standing Drill			
1.	Stand Easy		/5
2.	Stand at Ease		/5
3.	Attention		/5
4.	To the Front Salute		/5
5.	Left Turn		/5
6.	Right Turn		/5
7.	About Turn		/5
8.	Right Incline		/5
9.	About Turn		/5
10.	Open Order March		/5
11.	Right Dress		/5
12.	Eyes Front		/5
13.	Close Order March		/5
14.	Right Turn		/5
Marching Drill			
1.	Quick March		/5
2.	Mark Time		/5
3.	Forward		/5
4.	Mark Time		/5
5.	Halt		/5
6.	Quick March		/5
7.	Left Wheel		/5
8.	Left Wheel		/5
9.	Salute to the Right on the March		/5
10.	Left Wheel		/5
11.	Right Wheel		/5
12.	Right Wheel		/5
13.	Right Wheel		/5

14.	Mark Time		/5
15.	Halt		/5
	Standing Drill		
1.	Left Turn		/5
2.	Right Dress		/5
3.	Eyes Front		/5
	Sub-total		/
	Sub-total		/
Comments			
Penalties			
	Penalty Sub-total		
	Inspection		/
	DTC		/
	Compulsory		/
	Less Total Penalties		
	Grand Total		/
Name of Judge:			
Date:		Signature of Judge:	

CHAPTER 9

PO 111 – PARTICIPATE IN RECREATIONAL SUMMER BIATHLON ACTIVITIES



**COMMON TRAINING
GREEN STAR
INSTRUCTIONAL GUIDE**



SECTION 1

EO C111.01 - PARTICIPATE IN A BIATHLON BRIEFING

Total Time:

30 min

PREPARATION

PRE-LESSON INSTRUCTIONS

Resources needed for the delivery of this lesson are listed in the lesson specification located in A-CR-CCP-701/PG-001, *Green Star Qualification Standard and Plan*, Chapter 4. Specific uses for said resources are identified throughout the instructional guide within the TP for which they are required.

Review the lesson content and become familiar with the material prior to delivering the lesson.

Confirm the number of zones within your region.

PRE-LESSON ASSIGNMENT

Nil.

APPROACH

An interactive lecture was chosen for this lesson to introduce biathlon and provide an overview of the sport.

INTRODUCTION

REVIEW

Nil.

OBJECTIVES

By the end of this lesson, the cadet shall have participated in a biathlon briefing.

IMPORTANCE

It is important for cadets to participate in a biathlon briefing because it introduces the history and components of biathlon, as well as assists in preparing for a biathlon event.

Teaching Point 1**Introduce biathlon.**

Time: 10 min

Method: Interactive Lecture

THE SPORT OF BIATHLON

Traditionally, biathlon consists of two activities—small bore marksmanship and free technique cross country skiing. There are other forms of biathlon competition—these competitions must include an cardiovascular activity and a marksmanship component. The marksmanship component of biathlon demands fine motor control, great stability and precision. Traditionally a .22 cal small bore rifle is used. The combination of these two very contradictory activities makes the sport of biathlon.

Biathlon is considered a life sport. The first recorded biathlon competition took place near the Swedish / Norwegian border in 1767, between companies of border guards from the two countries. Biathlon continued to develop through hunting and warfare until it was introduced as a demonstration sport at the winter Olympics in Charmoix, France in 1924. It was not until 1960 in Squaw Valley, California and a change to small bore that biathlon became a fully-sanctioned Olympic event for men. In 1992 in Albertville, France, it became an Olympic event for women as well.

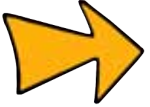

Cave drawings found in Norway, depicting Nordic skiing and the carrying of a weapon, date Biathlon back more than 5,000 years.

TYPES OF RACES

There are six different types of races used in biathlon competitions in the CCM.

INDIVIDUAL

An individual race consists of a single competitor start. It is a race of varying distances based on age, gender, weather, and the geographical constraints of the course location. An individual race consists of sequential bouts of skiing and firing, which may include:

1. skiing;
2. firing five rounds;
3. skiing;
4. firing five rounds;
5. skiing;
6. firing five rounds;
7. skiing; and
8. crossing the finish line.

The race is over when the last competitor crosses the finish line.

A time penalty of 40 seconds for every missed target is added to the competitor's final time.

SPRINT

A sprint race consists of a single competitor or group start. It is a race of varying distances based on age, gender, weather, and the geographical constraints of the course location. A sprint race consists of sequential bouts of skiing and firing, which may include:

1. skiing;
2. firing five rounds;
3. skiing;
4. firing five rounds;
5. skiing and
6. crossing the finish line.

The race is over when the last competitor crosses the finish line.

A penalty of skiing one loop for every missed target is added to the competitor's final time.

MASS

A mass race consists of a simultaneous start. It is a race of varying distances based on age, gender, weather, and the geographical constraints of the course location. A mass race consists of sequential bouts of skiing and firing, which may include:

1. skiing;
2. firing five rounds;
3. skiing;
4. firing five rounds;
5. skiing;
6. firing five rounds;
7. skiing;
8. fire five rounds;
9. skiing and
10. crossing the finish line.

The race is over when the last competitor crosses the finish line.

A penalty of skiing one loop for every missed target is added to the competitor's final time.

PURSUIT

A pursuit race consists of a single competitor start on random draw or results from a previous event during the same championship. It is a race of varying distances based on age, gender, weather, and the geographical constraints of the course location. A pursuit race consists of sequential bouts of skiing and firing, which may include:

1. skiing;
2. firing five rounds;

3. skiing;
4. firing five rounds;
5. skiing;
6. firing five rounds;
7. skiing;
8. firing five rounds;
9. skiing; and
10. crossing the finish line.

The race is over when the last competitor crosses the finish line.

A penalty of skiing one loop for every missed target is added to the competitor's final time.

RELAY

A relay race consists of a simultaneous start. It is a race of varying distances, based on age, gender, weather, and the geographical constraints of the course location. A relay race consists of sequential bouts of skiing and firing for each relay team member, which may include:

1. skiing;
2. firing five rounds (three spare);
3. skiing;
4. firing five rounds (three spare);
5. skiing;
6. tagging / touching either the torso, arms, hands, legs, feet, head or the rifle of the outgoing member of the team in the relay handover zone; and
7. the last skier completing the above sequence with no tagging / touching. They end the race by crossing the finish line.

The race is over when the last competitor of the last team crosses the finish line.

A penalty of skiing one loop for every missed target is added to the competitor's final time.

PATROL

A patrol race consists of a simultaneous start of a firing bout on the range. It is a race of varying distances, based on age, gender, weather, and the geographical constraints of the course location. The team must ski together with a distance of no further than 30 m apart from the first to the last skier. This distance is measured when they enter the range and cross the finish line. It may also be measured while on a skiing bout. Members of the patrol must carry patrol equipment in a pack. The equipment will vary, but usually consists of four to six wool blankets. The blankets are carried in packs and the division of the blankets is left to the discretion of the team. A patrol race consists of sequential bouts of skiing and firing, which may include:

1. firing up to 20 rounds;
2. skiing;
3. firing up to 20 rounds;

4. skiing;
5. firing up to 20 rounds;
6. skiing;
7. firing unlimited rounds; and finishing when the last paddle on the target indicates a hit.

A penalty of skiing one loop for every missed target is added to the competitor's final time.

Special rules for a patrol race

- Each competitor must fire at least twice.
- Teams cannot leave the range until all targets are hit or all 20 rounds are expended.
- Crossfiring is authorized as per rule 1.9.2. from *Biathlon Canada Handbook*. When a member of a team has hit all five of their targets they may fire at their team member's target. This can only occur after crossfire is called and the competitor who will not be firing unloads their rifle and places it on the mat.
- Five minutes will be added to the team's final time if two competitors fire on the same target at the same time.
- Each team must stay together as a group as per rule 1.9.3. from *Biathlon Canada Handbook*.
- Only during a patrol race may the rifle be supported by the pack on the firing line.
- A patrol member must be wearing or carrying their pack when crossing the finish line or entering the range.
- A patrol member must finish with their pack.

End of Patrol

There is a time limit on the patrol race. At the 45-minute mark, the range is closed to incoming teams and penalties are added to the team's final time. For each ski bout not completed by the team, a 15 minute time will be added to their final time.

FINAL RESULTS FOR ALL TYPES OF RACES

Results are based on ski time(s) combined with any time credits or penalties assessed to produce a final time. First place is awarded to the team with the lowest time.

CONFIRMATION OF TEACHING POINT 1

QUESTIONS:

- Q1. What two activities make up the sport of biathlon?
- Q2. What are the six types of biathlon races used in biathlon competitions in the CCM?
- Q3. In what race is crossfiring allowed?

ANTICIPATED ANSWERS:

- A1. A marksmanship and an cardiovascular activity.
- A2. Individual, sprint, mass, pursuit, relay, and patrol races.
- A3. Only in the patrol race IAW rule 1.9.3. from the *Biathlon Canada Handbook*.

Teaching Point 2**Describe competitive events in the CCM.**

Time: 15 min

Method: Interactive Lecture

LOCAL CORPS (STAGE 1)

At stage one the corps Commanding Officer (CO) is the Officer of Primary Interest (OPI) and will recommend who will participate in the zone competition based on the corps' biathlon program. If no biathlon program is in place at the corps, cadets may still compete at the CO's discretion. Biathlon teams consist of three competitors of the same gender, one of which must be a junior (have not reached the 15th birthday on or before 15 March of the training year).

ZONE (STAGE 2)

At stage two cadets will compete in a zone competition with corps in the same geographical area. Corps that cannot participate in a zone competition due to geographic limitations may conduct a local competition and mail in the results to the Zone / Regional Biathlon Coordinator who is the OPI for this stage. The regional biathlon coordinator is responsible for posting the names of the competitors who will advance to the provincial / territorial competition, based on the competitor's results, and the region's total allowable competitors.

PROVINCIAL / TERRITORIAL (STAGE 3)

At stage three the number of competitors in each category will depend on the number of zones in the region, and are decided by the Regional Biathlon Coordinator who is the OPI for this stage. These categories are female team, female composite team, male team, and male composite team. Composite teams are composed of top individual competitors in a zone, who are not necessarily from the same corps. Corps teams are selected based on the aggregate score of the fastest three competitors from the corps. Individual members of corps teams do not need to be declared until after the final race results are posted.

NATIONAL (STAGE 4)

Stage four in the selection process is based on the number of teams permitted to compete per region. The OPI for this stage is the National Biathlon Coordinator. Corps teams must contain the fastest junior and fastest senior competitor, plus the next fastest skier from the same corps based on their final time from the qualifying race.

Composite teams are selected based on final race times, from the remaining competitors who are not already selected for a corps team. Each composite team will consist of the next fastest senior competitor, next fastest junior competitor, and the next fastest competitor.



Discuss regional team allowances (located at Figure 1).

Teams	Atlantic				Eastern	Central	Prairie			Pacific	Northern
	NF	NS	NB	PEI	QC	ON	MB	SK	AB	BC	
Female Team	1	1	1	1	1	1	1	1	1	1	
Female Composite Team	1	1	1	1	2	2	1	1	1	1	1
Male Team	1	1	1	1	1	1	1	1	1	1	
Male Composite Team	1	1	1	1	2	2	1	1	1	1	1

Note. Created by D Cdts 4, 2006, Ottawa, ON: Department of National Defence.

Figure 1 Regional Disbursement of Teams

CONFIRMATION OF TEACHING POINT 2

QUESTIONS:

- Q1. What is the minimum number of junior competitors per team?
- Q2. How many levels of competitions are there in the CCM?
- Q3. How is the composite team selected?

ANTICIPATED ANSWERS:

- A1. There is a minimum of one junior competitor per team.
- A2. There are four levels of competition:
- corps,
 - zone,
 - provincial / territorial, and
 - national.
- A3. Composite teams are selected based on final race times, from the remaining competitors who are not already selected for a corps team. Each composite team will consist of the next fastest senior competitor, next fastest junior competitor, and the next fastest competitor.

END OF LESSON CONFIRMATION

The cadets' participation in the biathlon briefing will serve as the confirmation of this lesson.

CONCLUSION

HOMework / READING / PRACTICE

Nil.

METHOD OF EVALUATION

Nil.

CLOSING STATEMENT

Biathlon is a challenging and exciting individual and team sport that is challenging, exciting and promotes physical fitness, which is one of the aims of the cadet program.

INSTRUCTOR NOTES / REMARKS

Nil.

REFERENCES

A0-036 Cadets Canada. (n.d.). *Canadian cadet movement: Biathlon championship series*. Ottawa, ON: Department of National Defence.

C0-084 Biathlon Canada. (2003). *Biathlon Canada handbook*. Ottawa, ON: Biathlon Canada.



**COMMON TRAINING
GREEN STAR
INSTRUCTIONAL GUIDE**



**SECTION 2
EO C111.02 – RUN WIND SPRINTS**

Total Time:

30 min

PREPARATION

PRE-LESSON INSTRUCTIONS

Resources needed for the delivery of this lesson are listed in the lesson specification located in A-CR-CCP-701/PG-001, *Green Star Qualification Standard and Plan*, Chapter 4. Specific uses for said resources are identified throughout the instructional guide within the TP for which they are required.

Review the lesson content and become familiar with the material prior to delivering the lesson.

Ensure a first aid station is set up during the practical activities.

PRE-LESSON ASSIGNMENT

Nil.

APPROACH

An interactive lecture was chosen for TPs 1 and 2 to introduce cadets to the methods of preparing for a biathlon activity and running techniques.

A practical activity was chosen for TPs 3–5 as it is an interactive way to introduce the cadets to running skills in a safe and controlled environment. This activity contributes to the development of running skills and knowledge in a fun and challenging setting.

INTRODUCTION

REVIEW

Nil.

OBJECTIVES

By the end of this lesson the cadet shall be expected to have run wind sprints.

IMPORTANCE

It is important for cadets to run wind sprints because it is a method of increasing endurance, which will be useful when participating in summer biathlon activities.

Teaching Point 1**Explain how to prepare for summer biathlon activities.**

Time: 5 min

Method: Interactive Lecture

CLOTHING

Clothing worn while running is important for keeping the body temperature regulated as well as providing freedom of movement. Layering clothing is important because it maintains body heat and ensures comfort while outdoors.



Show examples of the clothing used for the different layers as they are described.

The Base / Core Layer

The layer next to the skin is called the base layer. It may consist of a synthetic undershirt that is close fitting but not tight. It should be made of a material that will absorb perspiration and move it away from the skin, such as polyester.



Damp clothes draw heat from the body, even in conditions above freezing. This rapid heat loss can cause a dangerous drop in body temperature.

The Mid-Layer

The second layer, called the mid-layer, provides insulation and moves moisture away from the base layer. This layer should be snug, but not constricting. It may consist of a zip-up shirt with a high neck or a shirt with a collar. In hot weather, this layer may be used as an outside layer.

The Outer Layer

The final layer, called the outer layer, provides protection from the elements. It should allow air to circulate and excess moisture to escape. It may consist of a wind shell or a waterproof rain jacket.

It is easier to stay warm rather than trying to warm up after getting cold. Additional insulating layers may be required to keep warm when sitting still in cold temperatures. Most of the heat from a person's body is lost through the head and face. It is always best to wear something on the head regardless of the weather conditions. In the summer, a hat protects the head from the sun and provides shade, while in the winter, a hat helps stop the heat from escaping.

FOOTWEAR

Running shoes should fit comfortably when laced up. Always wear clean, dry socks when wearing running shoes.

HYDRATION

The body is made up of over 60 percent water therefore hydration is crucial, particularly when participating in physical activity. The body continuously loses water through breathing, sweating, and urinating. It is recommended that water be drunk approximately two hours before exercise, often during exercise, and after exercise. Sports drinks are an alternative to water for those who run more than 4 km at one time, or who participate in more than an hour of moderate physical activity.

NUTRITION

It is important to follow the guidelines for healthy eating outlined in *Canada's Food Guide*, particularly for those who are physically active. Meals should be eaten at least 30 minutes prior to physical activity to allow time for the food to digest.

CONFIRMATION OF TEACHING POINT 1

QUESTIONS:

- Q1. Why is it important to layer your clothing?
- Q2. What percentage of the body is made up of water?
- Q3. Where can the guidelines for healthy eating be found?

ANTICIPATED ANSWERS:

- A1. It is important to layer clothing to maintain body heat and ensure comfort while outdoors.
- A2. Over 60 percent of the body is made up of water.
- A3. They can be found in *Canada's Food Guide*.

Teaching Point 2

Describe running techniques.

Time: 5 min

Method: Interactive Lecture

PACING

Pacing is the speed that should be run in order to cover the distance. It is essential to every runner and is important for maintaining energy and endurance. Individuals should pace themselves based on the signs felt from the body and the environmental conditions. An individual who cannot speak as they are running is considered to be running too fast or too long. This will prevent an individual from being able to run as long as runners who pace themselves accordingly.

In the beginning, the pace should be the anticipated average speed for the run. The pace may be increased at the halfway point, if this pace can be maintained for the remainder of the run. Towards the end of the run, energy should be gauged to determine if speed could be increased for the final portion of the run.



A good method for determining a comfortable pace is to use the "talk test". A runner should be able to talk comfortably while running, if not, the pace should be adjusted.

POSTURE / BODY ALIGNMENT

Having proper posture / body alignment can make running easier on the body and can increase an individual's performance. Basic techniques for posture / body alignment include keeping the hands at waist level to prevent tension in the arms and shoulders; remaining straight and erect, with head up, back straight, and shoulders level, to prevent shin splints and lower-back pain; and landing softly on the feet to avoid bouncing and to prevent wasting energy and to prevent injuries to the feet and legs.

WIND SPRINTS

Wind sprints are short bursts of high intensity movement conducted during regular aerobic activity, meant to make a person momentarily winded. For optimal benefits, physical activity must be continued after the wind

sprint is completed. Wind sprints can be conducted during any type of aerobic activity (eg, running, cycling, or swimming). Regular training with wind sprints may increase overall athletic performance.

CONFIRMATION OF TEACHING POINT 2

QUESTIONS:

- Q1. Why is pacing important for running?
- Q2. What is a good method of determining a comfortable pace for running?
- Q3. Describe one technique for posture / body alignment while running.

ANTICIPATED ANSWERS:

- A1. Pacing is important for runners to maintain energy and endurance.
- A2. The talk test is a good method of determining a comfortable pace for running.
- A3. Basic techniques for posture / body alignment include:
- keeping the hands at waist level, to prevent tension in the arms and shoulders;
 - remaining straight and erect, with head up, back straight, and shoulders level, to prevent shin splints and lower-back pain; and
 - landing softly on the feet to avoid bouncing and to prevent wasting energy and to prevent injuries to the feet and legs.

Teaching Point 3

Conduct a warm-up activity consisting of light cardiovascular exercises.

Time: 5 min

Method: Practical Activity



The following information will be explained to the cadets during the warm-up activity.

PURPOSE OF A WARM-UP

A warm-up is composed of stretches and light cardiovascular exercises designed to:

- stretch the muscles;
- gradually increase respiratory action and heart rate;
- expand the muscles' capillaries to accommodate the increase in blood circulation which occurs during physical activity; and
- raise the muscle temperature to facilitate reactions in muscle tissue.

GUIDELINES FOR STRETCHING

The following guidelines should be followed while stretching to prepare for physical activity and to help prevent injury:

- Stretch all major muscle groups, including the back, chest, legs, and shoulders.
- Never bounce while stretching.
- Hold each stretch for 10–30 seconds to let the muscles release fully.
- Repeat each stretch two to three times.
- When holding a stretch, support the limb at the joint.
- Static stretching, which is stretching a muscle and holding it in position without discomfort for 10–30 seconds, is considered the safest method.
- Stretching helps to relax the muscles and improve flexibility, which is the range of motion in the joints.
- As a guide, allow 10 minutes to warm up for every hour of physical activity.



The stretches chosen should focus on the areas of the body that will be used the most during the sports activity.

ACTIVITY

OBJECTIVE

The objective of this warm-up activity is to stretch the muscles and perform light cardiovascular exercises to prepare the body for physical activity and to help prevent injuries.

RESOURCES

Nil.

ACTIVITY LAYOUT

Nil.

ACTIVITY INSTRUCTIONS

- Arrange the cadets in either a warm-up circle or in rows (as illustrated in Figures 1 and 2).

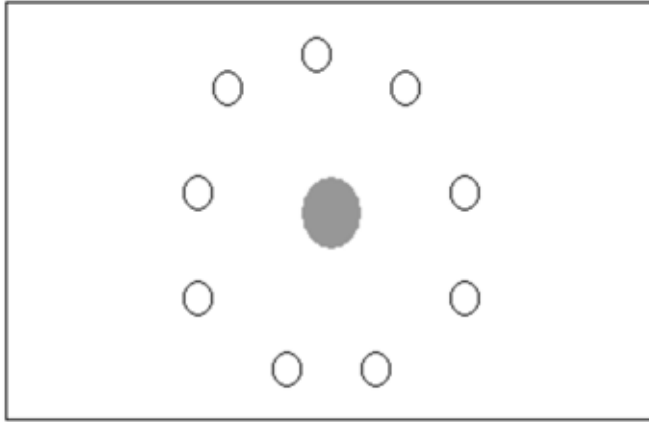

Note. Created by D Cdts 3, 2006, Ottawa, ON: Department of National Defence.

Figure 1 Instructor in the Centre of a Warm-Up Circle

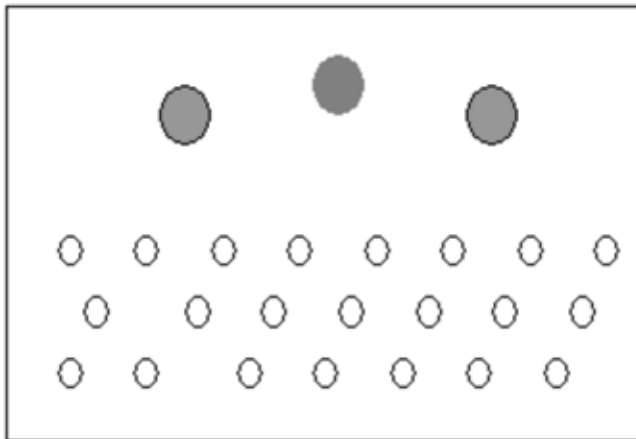

Note. Created by D Cdts 3, 2006, Ottawa, ON: Department of National Defence.

Figure 2 Instructor at the Front with Two Assistant Instructors

- Demonstrate before having the cadets attempt each stretch / light cardiovascular exercise.
- Assistant instructors can help demonstrate the exercises and ensure the cadets are performing them correctly.
- Have cadets perform each stretch / light cardiovascular exercise.



Light cardiovascular activities should be done to warm up the muscles prior to stretching to avoid injury to or tearing of the muscles. For example, running on the spot for 30 seconds or performing jumping jacks should be performed prior to conducting the stretching activities located at Attachment A.

SAFETY

- Ensure there are at least two arm lengths between the cadets so they can move freely.
- Ensure the cadets perform the stretches and light cardiovascular exercises in a safe manner, following the guidelines for stretching listed in this TP.

CONFIRMATION OF TEACHING POINT 3

The cadets' participation in the warm-up will serve as the confirmation of this TP.

Teaching Point 4**Supervise while the cadets run wind sprints.**

Time: 5 min

Method: Practical Activity

ACTIVITY

OBJECTIVE

The objective of this activity is to have the cadets practice running short wind sprints.

RESOURCES

- Area with level terrain that is large enough to conduct a run, and
- A whistle.

ACTIVITY LAYOUT

Nil.

ACTIVITY INSTRUCTIONS

- Have the cadets run at a comfortable pace.
- During the run, have the cadets complete a minimum of two wind sprints. To do a wind sprint:
 - give the cadets a warning before they start the wind sprint;
 - sound the start;
 - have the cadets run as fast as they can for approximately 30 seconds;
 - sound the finish of the sprint; and
 - instruct the cadets to return to their normal pace.

SAFETY

- Ensure a designated first aider and first aid kit are available.
- Ensure water is available for the cadets after they complete the run.

CONFIRMATION OF TEACHING POINT 4

The cadets' participation in running wind sprints will serve as the confirmation of this TP.

Teaching Point 5

Conduct a cool-down session composed of light cardiovascular exercises.

Time: 5 min

Method: Practical Activity



The following information will be explained to the cadets during the cool-down activity.

PURPOSE OF A COOL-DOWN

A cool-down is composed of stretches and light cardiovascular exercises designed to:

- allow the body time to slowly recover from physical activity and to help prevent injury;
- prepare the respiratory system to return to its normal state; and
- stretch the muscles to help relax and restore them to their resting length.



The stretches chosen should focus on the areas of the body that were used the most during the sports activity.

ACTIVITY

OBJECTIVE

The objective of the cool-down is to stretch the muscles and perform light cardiovascular exercises that allow the body time to recover from physical activity, and to prevent injury.

RESOURCES

Nil.

ACTIVITY LAYOUT

Nil.

ACTIVITY INSTRUCTIONS

- Arrange the cadets in either a warm-up circle or in rows (as illustrated in Figures 1 and 2 of TP 3).
- Demonstrate before having the cadets attempt each stretch / light cardiovascular exercise.
- Assistant instructors can help demonstrate the movements and ensure the cadets are performing them correctly.
- Have cadets perform each stretch / light cardiovascular exercise.

SAFETY

- Ensure there are at least two arm lengths between the cadets so they can move freely.
- Ensure the cadets perform the stretches and light cardiovascular exercises in a safe manner, following the guidelines for stretching listed in TP 3.

CONFIRMATION OF TEACHING POINT 5

The cadets' participation in the cool-down will serve as the confirmation of this TP.

END OF LESSON CONFIRMATION

The cadets' participation in running wind sprints will serve as the confirmation of this lesson.

CONCLUSION

HOMEWORK / READING / PRACTICE

Nil.

METHOD OF EVALUATION

Nil.

CLOSING STATEMENT

Wind sprints are a fun and challenging activity that may increase the overall athletic performance of an individual, which will be valuable when participating in summer biathlon activities.

INSTRUCTOR NOTES / REMARKS

Pictures of the clothing, hydration, and nutrition choices may be used in place of the actual items, if these items are not available.

REFERENCES

C0-002 ISBN 0-88962-630-8 LeBlanc, J. & Dickson, L. (1997). *Straight talk about children and sport: Advice for parents, coaches, and teachers*. Oakville, ON and Buffalo, NY: Mosaic Press.

C0-057 Martha Jefferson Hospital. (2001). *Warm-ups*. Retrieved October 16, 2006, from <http://www.marthajefferson.org/warmup.php>

C0-058 Webb Physiotherapists Inc. (n.d.). *Running exercises*. Retrieved October 26, 2006 from <http://www.physioline.co.za/conditions/article.asp?id=46>

C0-059 Webb Physiotherapists Inc. (n.d.). *Exercises programme for squash, tennis, softball, handball*. Retrieved October 25, 2006 from <http://www.physioline.co.za/conditions/article.asp?id=49>

C0-060 Impacto Protective Products Inc. (1998). *Exercises*. Retrieved October 25, 2006, from <http://www.2protect.com/work3b.htm>

C0-061 City of Saskatoon, Community Services Department. (2006). *Stretch your limits: A smart guide to stretching for fitness*. Retrieved October 26, 2006, from <http://in-motion.ca/walkingworkout/plan/flexibility/>

C0-078 Mountain Equipment Co-op. (2007). *Clothing info: Layering your clothing*. Retrieved February 12, 2007, from http://www.mec.ca/Main/content_text.jsp?FOLDER%3C%Efolder_id=2534374302881786&CONTENT%3C%Ecnt_id=10134198673220739&bmUID=1176745629068

C0-079 REI. (2007). *Outdoor fitness expert advice*. Retrieved February 12, 2007, from <http://www.rei.com/online/store/LearnShareArticlesList?categoryId=Crosstrain>

C0-080 Cool Running. (2007). *Fitness & performance*. Retrieved February 12, 2007, from http://www.coolrunning.com/engine/2/2_1index.shtml

C0-089 ISBN 0-936070-22-6 Anderson, B. (2000). *Stretching: 20th anniversary* (Rev. ed.). Bolinas, CA: Shelter Publications, Inc.

C0-100 ISBN 0-662-44467-1 Health Canada. (2007). *Canada's food guide*. Ottawa, ON: Her Majesty the Queen in Right of Canada.

C0-147 The HealthCentral Network. (2007). *MyDietExercise.com: Winds sprint your way to fitness*. Retrieved April 17, 2007, from <http://www.healthcentral.com/diet-exercise/fitness-survival-guides-81076-137.html>

C0-154 Hansen, B. (1999). *Moving on the spot: Fun and physical activity: A collection of 5 minute stretch and movement sessions*. Retrieved October 26, 2006, from <http://lin.ca/resource/html/dn3.htm#1>

SAMPLE STRETCHES

a. Neck:





 <p><i>Note. From Moving on the Spot: A Collection of 5 Minute Stretch and Movement Sessions, by B. Hanson, (1999), Toronto, Ontario: Toronto Public Health. Retrieved October 26, 2006, from http://www.lin.ca/resource/html/dn3.htm#1</i></p>	<p>Slowly roll your head across your chest from shoulder to shoulder. Do not roll your head backwards.</p>
--	--

Figure A-1 Neck Stretch

b. Shoulders:

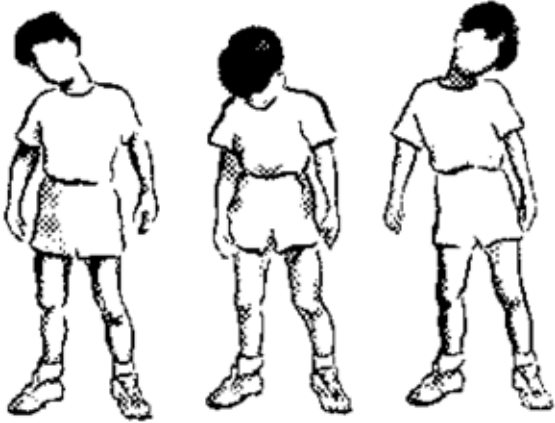
 <p><i>Note. From Moving on the Spot: A Collection of 5 minute Stretch and Movement Sessions, by B. Hanson, (1999), Toronto, Ontario: Toronto Public Health. Retrieved October 26, 2006, from http://www.lin.ca/resource/html/dn3.htm#1</i></p> <p>Figure A-2 Shoulder Push</p>	<p>Stand and extend your arms behind you, interlocking your fingers. Push up and back with your shoulders.</p> <p>Hold this position for a minimum of 10 seconds.</p>
 <p><i>Note. From Moving on the Spot: A Collection of 5 minute Stretch and Movement Sessions, by B. Hanson, (1999), Toronto, Ontario: Toronto Public Health. Retrieved October 26, 2006, from http://www.lin.ca/resource/html/dn3.htm#1</i></p> <p>Figure A-3 Shoulder Shrug</p>	<p>Stand and raise your shoulders as high as possible and then lower your shoulders, stretching your neck up.</p> <p>Pull your shoulders back as far as possible and then round your shoulders forward by pushing your shoulders forward as far as possible.</p> <p>Hold each position for a minimum of 10 seconds.</p>
 <p><i>Note. From Warm Ups, by Martha Jefferson Hospital, Copyright 2001 by Martha Jefferson Hospital. Retrieved October 26, 2006, from http://www.marthajefferson.org/warmup.php</i></p> <p>Figure A-4 Arm Circles</p>	<p>Hold your arms straight out, palms up. Make small circles with your arms, gradually increasing the size.</p> <p>Reverse the direction of your circles.</p>
 <p><i>Note. From Smart Start: A Flexible Way to Get Fit. Retrieved October 26, 2006, from http://www.in-motion.ca/walkingworkout/plan/flexibility/</i></p> <p>Figure A-5 Shoulder Stretch</p>	<p>Either standing or sitting, take your right arm in your left hand and bring it across your chest, supporting the joint by holding it behind the elbow. Pull lightly on the elbow towards your chest. You should feel the stretch in your right shoulder.</p> <p>Hold this position for a minimum of 10 seconds and repeat on the opposite side.</p>

c. Arms:



Note. From Exercises. Copyright 1998 by Impacto Protective Products Inc. Retrieved October 26, 2006, from <http://www.2protect.com/home.htm>

Figure A-6 Wrist Rotations

Rotate your hands in circular motions at the wrist.
Change direction and repeat on both sides.



Note. From Smart Start: A Flexible Way to Get Fit. Retrieved October 26, 2006, from <http://www.in-motion.ca/walkingworkout/plan/flexibility/>

Figure A-7 Triceps Stretch

Stand and bring your right arm over your head, bent at the elbow. Use your left hand to gently pull your arm down.
Hold this position for a minimum of 10 seconds and repeat on the opposite side.



Note. From Exercise Programme for Squash, Tennis, Softball, Handball. Retrieved October 26, 2006, from <http://www.physionline.co.za/conditions/article.asp?id=49>

Figure A-8 Forearm Stretch

In a kneeling position, place your hands on the floor in front of you turned so that your fingers are pointing toward your knees, and your thumbs are pointing out. Keeping your hands flat on the floor, lean back.
Hold this position for a minimum of 10 seconds.

d. Chest and Abdominals:



Note. From Smart Start: A Flexible Way to Get Fit. Retrieved October 26, 2006, from <http://www.in-motion.ca/walkingworkout/plan/flexibility/>

Figure A-9 Chest Stretch

Stand facing a wall. With your right arm bent and your elbow at shoulder height, place your palm against the wall. Turn your body away from your right arm. You should feel the stretch on the front side of your armpit and across the front of your chest.

Hold this position for a minimum of 10 seconds and repeat on the opposite side.



Note. From Moving on the Spot: A Collection of 5 minute Stretch and Movement Sessions, by B. Hanson, (1999), Toronto, Ontario: Toronto Public Health. Retrieved October 26, 2006, from <http://www.lin.ca/resource/html/dn3.htm#1>

Figure A-10 Side Stretch

Stand with your left arm up over your head. Bend at your waist towards the right side of your body.

Hold this position for a minimum of 10 seconds and repeat on the opposite side.

e. Back:



Note. From Smart Start: A Flexible Way to Get Fit. Retrieved October 26, 2006, from <http://www.in-motion.ca/walkingworkout/plan/flexibility/>

Figure A-11 Lower Back Stretch

Lie on your back and bring your knees toward your chest. Grasp the back of your knees.
Hold this position for a minimum of 10 seconds.

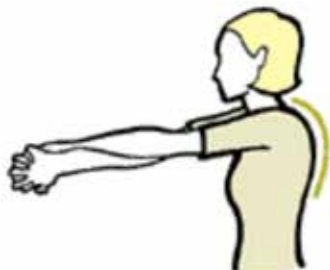

Note. From Smart Start: A Flexible Way to Get Fit. Retrieved October 26, 2006, from <http://www.in-motion.ca/walkingworkout/plan/flexibility/>

Figure A-12 Upper Back Stretch

Extend your arms straight in front of you at shoulder height crossing one arm over the other. With the palms facing each other, intertwine your fingers and press out through your arms. Let your chin fall to your chest as you exhale. You should feel the stretch in the upper back.

Hold this position for a minimum of 10 seconds and repeat on the opposite side.

f. Legs:



Note. From Smart Start: A Flexible Way to Get Fit. Retrieved October 26, 2006, from <http://www.in-motion.ca/walkingworkout/plan/flexibility/>

Figure A-13 Hamstring Stretch

Lie flat on the floor with your knees bent and your back flat on the floor. Slowly raise and straighten one leg, grasping it behind your thigh with both hands.

Hold this position for a minimum of 10 seconds.



Note. From Smart Start: A Flexible Way to Get Fit. Retrieved October 26, 2006, from <http://www.in-motion.ca/walkingworkout/plan/flexibility/>

Figure A-14 Inner Thigh Stretch

Sit on the floor with your knees bent and the soles of your feet together. Grab your toes and pull yourself forward while keeping your back and neck straight.

Hold this position for a minimum of 10 seconds.

Grab your ankles and push your knees down toward the floor with your elbows.

Hold this position for a minimum of 10 seconds.





Note. From Smart Start: A Flexible Way to Get Fit. Retrieved October 26, 2006, from <http://www.in-motion.ca/walkingworkout/plan/flexibility/>

Figure A-15 Hip Flexor

Kneel on your right knee. Position your left foot in front of you, bending your knee and placing your left hand on that leg for stability. Keep your back straight and abdominal muscles tight. Lean forward, shifting more body weight onto your front leg. You should feel the stretch in the front of your hip and the thigh of the leg you are kneeling on. Cushion your kneecap with a folded towel if necessary.

Hold this position for a minimum of 10 seconds and repeat on the opposite side.

f. Legs Continued:

 <p><i>Note. From Running Exercises. Retrieved October 26, 2006, http://www.physionline.co.za/conditions/article.asp?id=46</i></p> <p>Figure A-16 Ankle Rotations</p>	<p>From a sitting position, rotate your foot in a clockwise, and then a counter-clockwise, direction.</p> <p>Switch and repeat on the opposite side.</p>
 <p><i>Note. From Smart Start: A Flexible Way to Get Fit. Retrieved October 26, 2006, from http://www.in-motion.ca/walkingworkout/plan/flexibility/</i></p> <p>Figure A-17 Calf Stretch</p>	<p>Stand three steps away from and facing a wall. Step in towards the wall with your right leg, bending your right knee and keeping your left leg straight. Extending your arms with your palms forward, reach out to the wall and let your body fall toward the wall. Keep your toes forward and your heels down. Lean your body into the wall with your left leg straight behind your body. You should feel the stretch in your left calf.</p> <p>Hold this position for a minimum of 10 seconds and repeat on the opposite side.</p>
 <p><i>Note. From Smart Start: A Flexible Way to Get Fit. Retrieved October 26, 2006, from http://www.in-motion.ca/walkingworkout/plan/flexibility/</i></p> <p>Figure A-18 Quadriceps Stretch</p>	<p>Stand with your hand against a wall for balance. Lift your left foot off the ground, bending your knee as if you are trying to kick your bottom with your heel. Do not lean forward at the hips. Grab and hold your ankle with your left hand. You should feel the stretch in your left thigh.</p> <p>Hold this position for a minimum of 10 seconds and repeat on the opposite side.</p>

THIS PAGE INTENTIONALLY LEFT BLANK



**COMMON TRAINING
GREEN STAR
INSTRUCTIONAL GUIDE**



SECTION 3

EO C111.03 – SIMULATE FIRING THE CADET AIR RIFLE FOLLOWING PHYSICAL ACTIVITY

Total Time:

30 min

PREPARATION

PRE-LESSON INSTRUCTIONS

Resources needed for the delivery of this lesson are listed in the lesson specification located in A-CR-CCP-701/PG-001, *Green Star Qualification Standard and Plan*, Chapter 4. Specific uses for said resources are identified throughout the instructional guide within the TP for which they are required.

Review the lesson content and become familiar with the material prior to delivering the lesson.

Photocopy EO C111.02 Attachment A for TPs 3 and 5.

Construct a range IAW Chapter 1, Section 8 of A-CR-CCP-177/PPT-001 *Canadian Cadet Movement: Cadet Marksmanship Program Reference Manual*.

PRE-LESSON ASSIGNMENT

Nil.

APPROACH

An interactive lecture was chosen for TPs 1–2 to introduce techniques to decrease heart rate prior to firing the cadet air rifle at the Biathlon Air Rifle Target (BART).

A practical activity was chosen for TPs 3–5 as it is an interactive way to allow the cadets to experience firing the cadet air rifle following physical activity in a safe and controlled environment.

INTRODUCTION

REVIEW

Nil.

OBJECTIVES

By the end of this lesson the cadet shall be expected to fire the cadet air rifle following physical activity.

IMPORTANCE

It is important for cadets to fire the cadet air rifle following physical activity because these techniques will be useful when participating in summer biathlon activities.

Teaching Point 1**Identify techniques to decrease heart rate prior to firing the cadet air rifle.**

Time: 5 min

Method: Interactive Lecture

TECHNIQUES TO DECREASE HEART RATE**Cardiovascular Fitness**

One of the best methods to maintain a lower heart rate is to be physically fit. Being physically fit will also allow the heart to return to the resting heart rate quicker than someone who is not physically fit. The faster the heart rate decreases, the faster, and potentially more accurately firing may commence. A slower heart rate will also reduce the risk of movement and improve motor skills while firing.

VISUALIZATION

Visualization is seeing what you want to achieve. It is a practiced skill. Believing in oneself is directly linked to performance / outcome. To visualize, find a quiet place, close your eyes, and create a mental image of what you want to achieve. As with anything, the more one practices, the clearer the images will become. Visualizations should be positive and realistic. The purpose of visualizations for summer biathlon at this level is to visualize the heart rate slowing down and returning to the resting heart rate.

ACTIVITYTime: 2 min

OBJECTIVE

The objective of this activity is to visualize better performance.

RESOURCES

Nil.

ACTIVITY LAYOUT

Nil.

ACTIVITY INSTRUCTIONS

1. Have the cadets spread out around the room.
2. Instruct the cadets to hold their right arm out, turn as far to the right as they can without moving their feet, and point at a spot on the wall.
3. Instruct the cadets to return to their original standing position.
4. Have the cadets close their eyes and visualize themselves pointing at a spot on the wall that is farther than their original spot.
5. While keeping their eyes closed, have the cadets point to that spot on the wall using the same method outlined in step two.
6. Have the cadets open their eyes and see how far they have pointed.

SAFETY

Nil.

CONFIRMATION OF TEACHING POINT 1

The cadets' participation in the activity will serve as the confirmation of this TP.

Teaching Point 2**Describe the Biathlon Air Rifle Target (BART).**

Time: 5 min

Method: Interactive Lecture

TARGETS

The BART has the following characteristics:

- five 35 mm diameter drop plate targets,
- pop-up paddles for visual confirmation, and
- a manual reset with a 10 m pull cord.

This target has five black circular targets on white backgrounds. When a target is hit, a white paddle pops up, covering the circle. Once a round of firing is complete and the lane scorer has recorded the score, the cord is pulled and the target is reset.



Note. From "Biathlon Style Airgun Target", by Devin Mfg., Inc., 2005, Devin Manufacturing Incorporated, Copyright 2005 by Devin Mfg., Inc. Retrieved February 15, 2007 from <http://www.devinmfg.com/targets1.html>

Figure 1 BART

CONFIRMATION OF TEACHING POINT 2

QUESTIONS:

- Q1. What does BART stand for?
- Q2. What is one of the characteristics of the BART?
- Q3. How many targets are on the BART?

ANTICIPATED ANSWERS:

A1. Biathlon Air Rifle Target.

A2. The Biathlon Air Rifle Target (BART) has the following characteristics:

- five 35 mm diameter drop plate targets,
- pop-up paddles for visual confirmation, and
- a manual reset with a 10 m pull cord.

A3. There are five targets on the BART.

Teaching Point 3

Conduct a warm-up session composed of light cardiovascular exercises.

Time: 5 min

Method: Practical Activity



The following information will be explained to the cadets during the warm-up activity.

PURPOSE OF A WARM-UP

A warm-up is composed of stretches and light cardiovascular exercises designed to:

- stretch the muscles;
- gradually increase respiratory action and heart rate;
- expand the muscles' capillaries to accommodate the increase in blood circulation which occurs during physical activity; and
- raise the muscle temperature to facilitate reactions in muscle tissue.

GUIDELINES FOR STRETCHING

The following guidelines should be followed while stretching to prepare for physical activity and to help prevent injury:

- Stretch all major muscle groups, including the back, chest, legs, and shoulders.
- Never bounce while stretching.
- Hold each stretch for 10–30 seconds to let the muscles release fully.
- Repeat each stretch two to three times.
- When holding a stretch, support the limb at the joint.
- Static stretching, which is stretching a muscle and holding it in position without discomfort for 10–30 seconds, is considered the safest method.
- Stretching helps to relax the muscles and improve flexibility, which is the range of motion in the joints.
- As a guide, allow 10 minutes to warm up for every hour of physical activity.



The stretches chosen should focus on the areas of the body that will be used the most during the activity.

ACTIVITY

OBJECTIVE

The objective of this warm-up activity is to stretch the muscles and perform light cardiovascular exercises to prepare the body for physical activity and to help prevent injuries.

RESOURCES

Nil.

ACTIVITY LAYOUT

Nil.

ACTIVITY INSTRUCTIONS

- Arrange the cadets in either a warm-up circle or in rows (as illustrated in Figures 2 and 3).

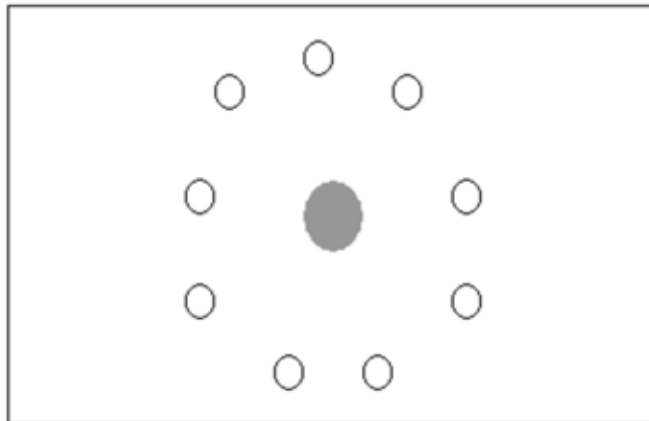

Note. Created by D Cdts 3, 2006, Ottawa, ON: Department of National Defence.

Figure 2 Instructor in the Centre of a Warm-Up Circle

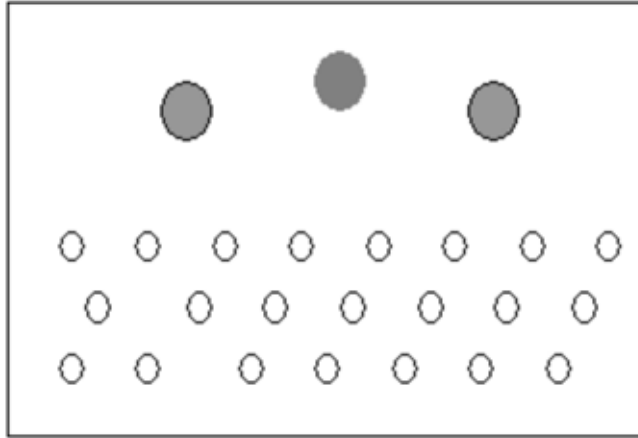

Note. Created by D Cdt's 3, 2006, Ottawa, ON: Department of National Defence.

Figure 3 Instructor at the Front with Two Assistant Instructors

- Demonstrate before having the cadets attempt each stretch / light cardiovascular exercise.
- Assistant instructors can help demonstrate the exercises and ensure the cadets are performing them correctly.
- Have cadets perform each stretch / light cardiovascular exercise.



Light cardiovascular activities should be done to warm up the muscles prior to stretching to avoid injury to or tearing of the muscles. For example, running on the spot for 30 seconds or performing jumping jacks should be performed prior to conducting the stretching activities located at EO C111.02 Attachment A.

SAFETY

- Ensure there are at least two arm lengths between the cadets so they can move freely.
- Ensure the cadets perform the stretches and light cardiovascular exercises in a safe manner, following the guidelines for stretching listed in this TP.

CONFIRMATION OF TEACHING POINT 3

The cadets' participation in the warm-up will serve as the confirmation of this TP.

Teaching Point 4

Conduct an activity where cadets will fire the cadet air rifle following physical activity.

Time: 5 min

Method: Practical Activity

ACTIVITY

OBJECTIVE

The objective of this activity is to fire the cadet air rifle following physical activity.

RESOURCES

- Cadet air rifles (one per firing lane),
- Marksmanship mats (two per firing lane),
- BART and target frame (one per firing lane), and
- Safety glasses / goggles.



If resources are available the number of firing lanes may be increased.

ACTIVITY LAYOUT

Construct a range IAW A-CR-CCP-177/PT-001 *Canadian Cadet Movement: Cadet Marksmanship Program Reference Manual*.

ACTIVITY INSTRUCTIONS

1. The cadets' heart rate should be elevated from participating in the warm-up activity in TP 3.
2. Have the cadets approach the firing point and prepare to fire using the techniques outlined in TP 1.
3. Have the cadets adopt the prone position and simulate firing at the BART.
4. Repeat steps one to three for each relay until all cadets have participated.

SAFETY

Range activities will be conducted IAW A-CR-CCP-177/PT-001 *Canadian Cadet Movement: Cadet Marksmanship Program Reference Manual*.

CONFIRMATION OF TEACHING POINT 4

The cadets' participation in the activity will serve as the confirmation of this TP.

Teaching Point 5

Conduct a cool-down session composed of light cardiovascular exercises.

Time: 5 min

Method: Practical Activity



The following information will be explained to the cadets during the cool-down activity.

PURPOSE OF A COOL-DOWN

A cool-down is composed of stretches and light cardiovascular exercises designed to:

- allow the body time to slowly recover from physical activity and to help prevent injury;
- prepare the respiratory system to return to its normal state; and
- stretch the muscles to help relax and restore them to their resting length.



The stretches chosen should focus on the areas of the body that were used the most during the activity.

ACTIVITY

OBJECTIVE

The objective of the cool-down is to stretch the muscles and perform light cardiovascular exercises that allow the body time to recover from physical activity, and to prevent injury.

RESOURCES

Nil.

ACTIVITY LAYOUT

Nil.

ACTIVITY INSTRUCTIONS

- Arrange the cadets in either a warm-up circle or in rows (as illustrated in Figures 2 and 3 of TP 3).
- Demonstrate before having the cadets attempt each stretch / light cardiovascular exercise.
- Assistant instructors can help demonstrate the movements and ensure the cadets are performing them correctly.
- Have cadets perform each stretch / light cardiovascular exercise.

SAFETY

- Ensure there are at least two arm lengths between the cadets so they can move freely.
- Ensure the cadets perform the stretches and light cardiovascular exercises in a safe manner, following the guidelines for stretching listed in TP 3.

CONFIRMATION OF TEACHING POINT 5

The cadets' participation in the cool-down will serve as the confirmation of this TP.

END OF LESSON CONFIRMATION

The cadets' participation in the activity in TP 4 will serve as the confirmation of this lesson.

CONCLUSION

HOMEWORK / READING / PRACTICE

Nil.

METHOD OF EVALUATION

Nil.

CLOSING STATEMENT

Being able to use techniques, such as visualization, to slow down the heart rate will be useful when participating in summer biathlon activities.

INSTRUCTOR NOTES / REMARKS

Cadets must have completed PO 106 (Fire the Cadet Air Rifle) prior to participating in this lesson.

REFERENCES

A0-027 A-CR-CCP-177/PT-001 D Cdts 3. (2001). *Cadet marksmanship program: Reference manual*. Ottawa, ON: Department of National Defence.

C0-002 ISBN 0-88962-630-8 LeBlanc, J. & Dickson, L. (1997). *Straight talk about children and sport: Advice for parents, coaches, and teachers*. Oakville, ON and Buffalo, NY: Mosaic Press.

C0-057 Martha Jefferson Hospital. (2001). *Warm-ups*. Retrieved October 26, 2006, from <http://www.marthajefferson.org/warmup.php>

C0-058 Webb Physiotherapists Inc. (n.d.). *Running exercises*. Retrieved October 26, 2006, from <http://www.physionline.co.za/conditions/article.asp?id=46>

C0-059 Webb Physiotherapists Inc. (n.d.). *Exercise programme for squash, tennis, softball, handball*. Retrieved October 25, 2006, from <http://www.physionline.co.za/conditions/article.asp?id=49>

C0-060 Impacto Protective Products Inc. (1998). *Exercises*. Retrieved October 25, 2006, from <http://www.2protect.com/work3b.htm>

C0-061 City of Saskatoon, Community Services Department. (2006). *Stretch your limits: A smart guide to stretching for fitness*. Retrieved October 26, 2006, from <http://www.in-motion.ca/walkingworkout/plan/flexibility/>

C0-089 ISBN 0-936070-22-6 Anderson, B. (2000). *Stretching: 20th anniversary* (Rev. ed.). Bolinas, CA: Shelter Publications, Inc.

C0-150 ISBN 0-88011-463-0 Nideffer, R. PhD. (1992). *Psyched to win: How to master mental skills to improve your physical performance*. Champaign, IL: Leisure Press.

C0-151 Devin Manufacturing Incorporated. (2005). *Biathlon style airgun target*. Retrieved February 15, 2007 from <http://www.devinmfg.com/targets1.html>

C0-154 Hansen, B. (1999). *Moving on the spot: Fun and physical activity: A collection of 5 minute stretch and movement sessions*. Retrieved October 26, 2006, from <http://lin.ca/resource/html/dn3.htm#1>

THIS PAGE INTENTIONALLY LEFT BLANK



COMMON TRAINING
GREEN STAR
INSTRUCTIONAL GUIDE



SECTION 4

EO C111.04 - PARTICIPATE IN A RECREATIONAL SUMMER BIATHLON ACTIVITY

Total Time:

180 min

PREPARATION

PRE-LESSON INSTRUCTIONS

Resources needed for the delivery of this lesson are listed in the lesson specification located in A-CR-CCP-701/PG-001, *Green Star Qualification Standard and Plan*, Chapter 4. Specific uses for said resources are identified throughout the instructional guide within the TP for which they are required.

Review the lesson content and become familiar with the material prior to delivering the lesson.

Ensure that all members involved in conducting this activity are well versed in the competition guidelines located at Attachment A.

Photocopy EO C111.02 Attachment A for TPs 3 and 5.

Photocopy Attachment B as required.

Ensure a first aid station is set up.

Set up a running route of 250–500 m on level terrain and a range IAW A-CR-CCP-177/PT-001 *Canadian Cadet Movement: Cadet Marksmanship Program Reference Manual*.

PRE-LESSON ASSIGNMENT

Nil.

APPROACH

An experiential approach was chosen for this lesson as it allows the cadets to acquire new knowledge and skills through a direct experience. The cadets experience summer biathlon and define that experience on a personal level. The cadets will be given the opportunity to reflect on and examine what they saw, felt and thought while participating in summer biathlon and consider how it relates to what they already learned and experienced as well as how it will relate to future experiences.

INTRODUCTION

REVIEW

Nil.

OBJECTIVES

By the end of this lesson the cadet shall have participated in a recreational summer biathlon activity.

IMPORTANCE

It is important for cadets to participate in a recreational summer biathlon activity because it requires personal discipline, develops marksmanship skills, and promotes physical fitness.

Teaching Point 1**Conduct the activity briefing.**

Time: 30 min

Method: Interactive Lecture



Based on the facilities, the cadet should be made aware of the start area, the course, the firing range, and the finish area.

COURSE LAYOUT

Each cadet will:

- run a loop of 250–500 m;
- fire five to eight pellets in an effort to activate all five targets on the (BART);
- run a loop of 250–500 m;
- fire five to eight pellets in an effort to activate all five targets on the BART;
- run a loop of 250–500 m; and
- finish the race.



The 250–500 m course should be clearly marked prior to the start of this lesson.

RULES AND REGULATIONS

Rules and regulations for the recreational summer biathlon activity include the following:

- Cadets must use the same firing lane for the duration of the activity.
- The run must be completed in the proper sequence and on the marked route.
- Rifles must be placed at the firing point by the range staff and will remain there for the duration of the activity.
- All firing will be done in the prone position.
- The rifle must be made safe upon completion of firing.
- An inoperable rifle will be replaced by the range staff, the target will be reset, and the cadet will fire five to eight shots with the new rifle.
- Safety infractions will result in time penalties.
- Missed targets will result in time penalties.

SCORING

The scoring of this biathlon activity will be based on time and penalties.

PENALTIES

Penalties will be added to the individual's time, to include:

- Each violation of the principles of fair play or good sportsmanship will result in a one-minute penalty, to include:
 - not giving way in an area of congestion;
 - pushing or shoving;
 - using profanity; and
 - interfering with other competitors.
- Each missed target will result in a one-minute penalty.
- Each safety infraction on the firing point will result in a one-minute penalty to include:
 - not keeping control of the cadet air rifle;
 - moving forward of the firing point; and
 - intentionally firing rounds at objects other than the BART.

OUT OF BOUNDS AREAS

Make cadets aware of all out of bounds areas and safety considerations depending on the training area.

CONFIRMATION OF TEACHING POINT 1

QUESTIONS:

- Q1. What are two rules / regulations for this biathlon activity?
- Q2. How will the recreational summer biathlon activity be scored?
- Q3. What is one very minor violation of the principles of fair play / good sportsmanship?

ANTICIPATED ANSWERS

- A1. Rules and regulations for the recreational summer biathlon activity include the following:
- Cadets must use the same firing lane for the duration of the activity.
 - The run must be completed in the proper sequence and on the marked route.
 - Rifles must be placed at the firing point by the range staff and will remain there for the duration of the activity.
 - All firing will be done in the prone position.
 - The cadet air rifle sling is the only firing aid that may be used.
 - The rifle must be made safe upon completion of firing.
 - An inoperable rifle will be replaced by the range staff, the target will be reset, and the cadet will fire five to eight shots with the new rifle.
 - Safety infractions will result in time penalties.
 - Missed targets will result in time penalties.
- A2. The activity will be scored based on time and penalties.

A3. A very minor violation of the principles of fair play / good sportsmanship include:

- not giving way in an area of congestion;
- pushing or shoving;
- using profanity; and
- interfering with other competitors.

Teaching Point 2

Conduct a warm-up session composed of light cardiovascular exercises.

Time: 10 min

Method: Practical Activity



The following information will be explained to the cadets during the warm-up activity.

PURPOSE OF A WARM-UP

A warm-up is composed of stretches and light cardiovascular exercises designed to:

- stretch the muscles;
- gradually increase respiratory action and heart rate;
- expand the muscles' capillaries to accommodate the increase in blood circulation which occurs during physical activity; and
- raise the muscle temperature to facilitate reactions in muscle tissue.

GUIDELINES FOR STRETCHING

The following guidelines should be followed while stretching to prepare for physical activity and to help prevent injury:

- Stretch all major muscle groups, including the back, chest, legs, and shoulders.
- Never bounce while stretching.
- Hold each stretch for 10–30 seconds to let the muscles release fully.
- Repeat each stretch two to three times.
- When holding a stretch, support the limb at the joint.
- Static stretching, which is stretching a muscle and holding it in position without discomfort for 10–30 seconds, is considered the safest method.
- Stretching helps to relax the muscles and improve flexibility, which is the range of motion in the joints.
- As a guide, allow 10 minutes to warm up for every hour of physical activity.



The stretches chosen should focus on the areas of the body that will be used the most during the activity.

ACTIVITY

OBJECTIVE

The objective of this warm-up activity is to stretch the muscles and perform light cardiovascular exercises to prepare the body for physical activity and to help prevent injuries.

RESOURCES

Nil.

ACTIVITY LAYOUT

Nil.

ACTIVITY INSTRUCTIONS

- Arrange the cadets in either a warm-up circle or in rows (as illustrated in Figures 1 and 2).

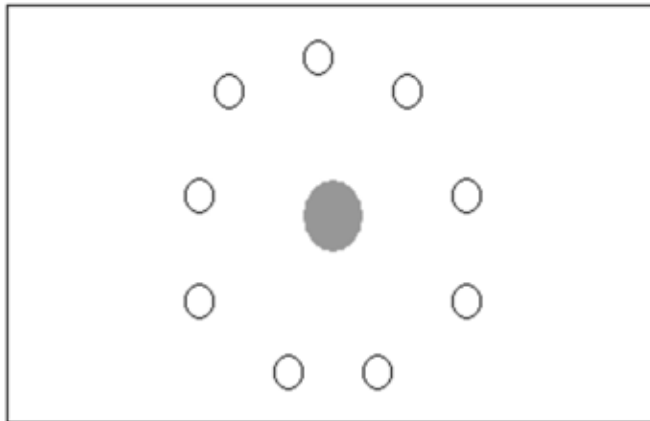

Note. Created by D Cdts 3, 2006, Ottawa, ON: Department of National Defence.

Figure 1 Instructor in the Centre of a Warm-Up Circle

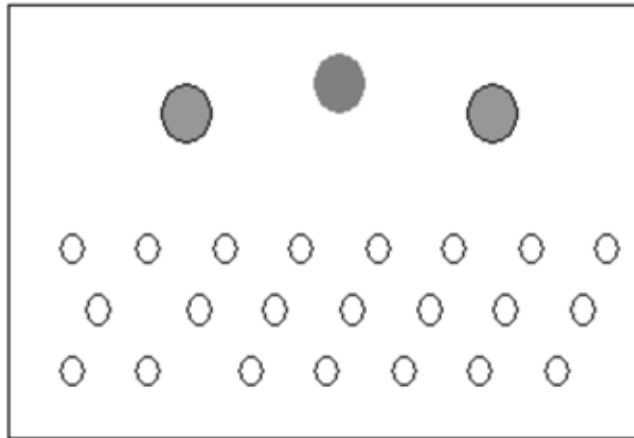

Note. Created by D Cdts 3, 2006, Ottawa, ON: Department of National Defence.

Figure 2 Instructor at the Front with Two Assistant Instructors

- Demonstrate before having the cadets attempt each stretch / light cardiovascular exercise.
- Assistant instructors can help demonstrate the exercises and ensure the cadets are performing them correctly.
- Have cadets perform each stretch / light cardiovascular exercise.



Light cardiovascular activities should be done to warm up the muscles prior to stretching to avoid injury to or tearing of the muscles. For example, running on the spot for 30 seconds or performing jumping jacks should be performed prior to conducting the stretching activities located at EO C111.03 Attachment A.

SAFETY

- Ensure there are at least two arm lengths between the cadets so they can move freely.
- Ensure the cadets perform the stretches and light cardiovascular exercises in a safe manner, following the guidelines for stretching listed in this TP.

CONFIRMATION OF TEACHING POINT 2

The cadets' participation in the activity will serve as the confirmation of this TP.

Teaching Point 3

Conduct a recreational summer biathlon activity.

Time: 100 min

Method: Practical Activity

ACTIVITY

OBJECTIVE

The objective of this activity is for cadets to participate in a recreational summer biathlon activity.

RESOURCES

Based on 20 cadets per group, the following resources are required per event:

- Cadet air rifles (5),
- Marksmanship mats (10),
- .177 air rifle pellets (a minimum of 700 pellets),
- Stop watches (5),
- BART and target frame (5),
- Safety glasses / goggles (8),
- Pens / pencils,
- Notice board,
- Biathlon score sheets located at Attachment B,
- Course control sheets located at Attachment B, and
- Range recording sheets located at Attachment B.

ACTIVITY LAYOUT

- Set up a running route of approximately 250–500 m on level terrain.
- Set up an air rifle range IAW Attachment A.
- Set up targets and target frames.
- Place two mats per firing lane.
- Place a cadet air rifle at each firing point.
- Place a pair of safety glasses / goggles at each firing point.

ACTIVITY INSTRUCTIONS

Activity instructions are located at Attachment A.

SAFETY

- Ensure all range safety procedures are followed.
- Ensure cadets drink plenty of water and apply sunscreen.
- Ensure the running route is clearly marked and crossing points are monitored anywhere a road may be crossed.
- Ensure a first aider is identified at the start of the activity and is available at all times.
- Ensure water is available for the cadets during and after the activity.

CONFIRMATION OF TEACHING POINT 3

The cadets' participation in the activity will serve as the confirmation of this TP.

Teaching Point 4**Conduct a cool-down session composed of light cardiovascular exercises.**

Time: 10 min

Method: Practical Activity



The following information will be explained to the cadets during the cool-down activity.

PURPOSE OF A COOL-DOWN

A cool-down is composed of stretches and light cardiovascular exercises designed to:

- allow the body time to slowly recover from physical activity and to help prevent injury;
- prepare the respiratory system to return to its normal state; and
- stretch the muscles to help relax and restore them to their resting length.



The stretches chosen should focus on the areas of the body that were used the most during the activity.

ACTIVITY

OBJECTIVE

The objective of the cool-down is to stretch the muscles and perform light cardiovascular exercises that allow the body time to recover from physical activity, and to prevent injury.

RESOURCES

Area large enough for all cadets to conduct a cool-down activity.

ACTIVITY LAYOUT

Nil.

ACTIVITY INSTRUCTIONS

- Arrange the cadets in either a cool-down circle or in rows (as illustrated in Fig. 1 and 2 of TP 2).
- Demonstrate before having the cadets attempt each stretch / light cardiovascular exercise.
- Assistant instructors can help demonstrate the movements and ensure the cadets are performing them correctly.
- Have cadets perform each stretch / light cardiovascular exercise.



Sample stretches are located at EO C111.02 (Run Wind Sprints) Attachment A.

SAFETY

- Ensure there are at least two arm lengths between the cadets so they can move freely.
- Ensure the cadets perform the stretches and light cardiovascular exercises in a safe manner following the guidelines for stretching listed in TP 2.

CONFIRMATION OF TEACHING POINT 4

The cadets' participation in the activity will serve as the confirmation of this TP.

Teaching Point 5

Conduct a debriefing.

Time: 10 min

Method: Group Discussion



The point of the group discussion is to allow the cadets to share what they have learned from their experience.



TIPS FOR ANSWERING / FACILITATING DISCUSSION:

- Establish ground rules for discussion, eg, everyone should listen respectfully; don't interrupt; only one person speaks at a time; no one's ideas should be made fun of; you can disagree with ideas but not with the person; try to understand others as much as you hope they understand you; etc.
- Sit the group in a circle, making sure all cadets can be seen by everyone else.
- Ask questions that will provoke thought; in other words avoid questions with yes or no answers.
- Manage time by ensuring the cadets stay on topic.
- Listen and respond in a way that indicates you have heard and understood the cadet. This can be done by paraphrasing their ideas.
- Give the cadets time to respond to your questions.
- Ensure every cadet has an opportunity to participate. One option is to go around the group and have each cadet answer the question with a short answer. Cadets must also have the option to pass if they wish.
- Additional questions should be prepared ahead of time.

SUGGESTED QUESTIONS:

- Q1. What did you enjoy the most about the activity?
- Q2. What challenges did you encountered while participating in the activity?
- Q3. What have you learned about yourself by participating in the activity? About your marksmanship skills?
About your physical fitness ability?

CONFIRMATION OF TEACHING POINT 5

The cadets' participation in the activity will serve as the confirmation of this TP.

END OF LESSON CONFIRMATION

The cadets' participation in a recreational summer biathlon activity will serve as the confirmation of this lesson.

CONCLUSION

HOMEWORK / READING / PRACTICE

Nil.

METHOD OF EVALUATION

Nil.

CLOSING STATEMENT

Recreational summer biathlon is an activity that requires personal discipline, develops marksmanship skills, and promotes physical fitness. Competitive biathlon opportunities are available at the local, regional, and national level.

INSTRUCTOR NOTES / REMARKS

Results should be posted for cadets to review. PO 111 is a complementary training activity. It is designed to provide an opportunity for the cadets to participate in a recreational summer biathlon activity.

EO C111.01 (Participate in a Biathlon Briefing), EO C111.02 (Run Wind Sprints), EO C111.03 (Simulate Firing the Cadet Air Rifle Following Physical Activity) shall be taught prior to instructing this lesson.

The start and finish should be located in the same area, close to the firing point

REFERENCES

A0-027 A-CR-CCP-177/PT-001 D Cdts 3. (2001). *Canadian cadet movement: cadet marksmanship program reference manual*. Ottawa, ON: Department of National Defence.

A0-032 Cadets Canada. (2002). *Biathlon competition rules and IBU / cadet disciplinary rules*. Ottawa, ON: Department of National Defence.

A0-036 Cadets Canada. (n.d.). *Canadian cadet movement: Biathlon championship series*. Ottawa, ON: Department of National Defence.

C0-002 ISBN 0-88962-630-8 LeBlanc, J. & Dickson, L. (1997). *Straight talk about children and sport: Advice for parents, coaches, and teachers*. Oakville, ON and Buffalo, NY: Mosaic Press.

C0-057 Martha Jefferson Hospital. (2001). *Warm-ups*. Retrieved October 26, 2006, from <http://www.marthajefferson.org/warmup.php>

C0-058 Webb Physiotherapists Inc. (n.d.). *Running exercises*. Retrieved October 26, 2006, from <http://www.physionline.co.za/conditions/article.asp?id=46>

C0-059 Webb Physiotherapists Inc. (n.d.). *Exercise programme for squash, tennis, softball, handball*. Retrieved October 25, 2006, from <http://www.physionline.co.za/conditions/article.asp?id=49>

C0-060 Impacto Protective Products Inc. (1998). *Exercises*. Retrieved October 25, 2006, from <http://www.2protect.com/work3b.htm>

C0-061 City of Saskatoon, Community Services Department. (2006). *Stretch your limits: A smart guide to stretching for fitness*. Retrieved October 26, 2006, from <http://www.in-motion.ca/walkingworkout/plan/flexibility/>

C0-089 ISBN 0-936070-22-6 Anderson, B. (2000). *Stretching: 20th anniversary* (Rev. ed.). Bolinas, CA: Shelter Publications, Inc.

C0-154 Hansen, B. (1999). *Moving on the spot: Fun and physical activity: A collection of 5 minute stretch and movement sessions*. Retrieved October 26, 2006, from <http://lin.ca/resource/html/dn3.htm#1>

GUIDELINES TO CONDUCT A RECREATIONAL SUMMER BIATHLON ACTIVITY

OBJECTIVES

The objectives of the recreational summer biathlon activity are:

- to practice and improve marksmanship skills;
- to improve the level of physical fitness; and
- to introduce cadets to the sport of summer biathlon.

COMPOSITION

Each Green Star cadet will enter as an individual.

FACILITIES

The facilities required to conduct a recreational summer biathlon activity are:

- a route, on level terrain, of approximately 250–500 m with the start and finish lines located close to the range. The route should be wide enough to accommodate a maximum of 10 cadets running at one time. When roads are to be crossed, they must be clearly marked and a central crossing point established with traffic control provided, and
- an air rifle range constructed IAW Part 1, Section 8 of A-CR-CCP-177/PT-001, with a minimum of one firing lane per cadet per group.

STAFFING

Numerous staff are required to conduct a recreational summer biathlon activity. These appointments may be filled by corps staff, and shall include:

- **Technical Delegate (TD).** Responsible for the overall conduct of the competition, including issuing penalties, and interpreting the rules.
- **Range Safety Officer (RSO).** Responsible for the overall conduct of the activities on the range.
- **Assistant RSO.** Responsible for targets, issuing ammunition, and assisting the RSO, as required.
- **Lane Scorekeeper.** Responsible for scoring targets and recording results on the range recording sheet (located at Attachment B).
- **Chief of Statistics.** Responsible for compiling all the event data (eg, range results, start / finish time, and any penalties assessed).
- **Runner.** Responsible for collecting the scoring sheets and delivering them to the chief of statistics.
- **Start and Finish Line Chief.** Responsible for starting the run and recording the finish times on the score sheet (located at Attachment B).
- **Course Control.** Responsible for recording each time the cadet runs a loop on the course control sheet (located at Attachment B).
- **First Aider.** Responsible for dealing with any injuries that may occur during the competition.

FORMAT

Team Captain's Meeting

All cadets will attend the team captain's meeting. This meeting includes all the essential information required by the cadets to participate in the recreational summer biathlon activity. The cadets are given:

- start times,
- range lane assignments,
- weather updates, and
- introductions of the competition staff.

The Running Loop

Each cadet will run three separate loops of 250–500 m. Each running loop will consist of:

- assembling for an individual start (cadets will begin at 10-second intervals for the first loop); and
- crossing the finish line.

The Range

Each cadet will fire five to eight pellets in an effort to activate all five targets on the BART. After each bout of firing, the appropriate lane scorer will record the cadet's results and reset the BART.

SEQUENCE

This recreational summer biathlon activity will be conducted in the following sequence:

1. running a loop of 250–500 m;
2. firing five to eight pellets at the BART;
3. running a loop of 250–500 m;
4. firing five to eight pellets at the BART;
5. running a third loop of 250–500 m; and
6. crossing the finish line.

EQUIPMENT

Based on 20 cadets per group, the equipment required to conduct the recreational summer biathlon activity shall include, but is not limited to the following:

- Cadet air rifles (5),
- Marksmanship mats (10),
- .177 air rifle pellets (a minimum of 700 pellets),
- Stop watches (5),
- BART and target frame (5),
- Safety glasses / goggles (8),
- Pens / pencils,
- Notice board,

- Biathlon score sheets located at Attachment B,
- Course control sheets located at Attachment B, and
- Range recording sheets located at Attachment B.

DRESS

Appropriate clothing according to the weather forecast.

RULES AND REGULATIONS

- Cadets must use the same firing lane for the duration of the activity.
- The run must be completed in the proper sequence and on the marked route.
- Rifles must be placed on the firing point by the range staff and will remain there for the duration of the activity.
- All firing will be done in the prone position.
- The rifle must be made safe upon completion of firing.
- An inoperable rifle will be replaced by the range staff, the target will be reset, and the cadet will fire five to eight shots with the new rifle.
- Safety infractions will result in time penalties.
- Missed targets will result in time penalties.

SCORING

Scoring will be completed as follows:

- **Time.** The cadet's final time is the time from the start to finish, plus any issued penalties.
- **Firing.** For each bout of firing, the number of missed targets will be recorded on the range recording sheet by the lane scorekeeper (located at Attachment B). For each missed target, a one-minute penalty will be added to the cadet's total time.

PENALTIES

Penalties will be added to the individual's time, to include:

- Each violation of the principles of fair play or good sportsmanship will result in a one-minute penalty, to include:
 - not giving way in an area of congestion;
 - pushing or shoving;
 - using profanity; and
 - interfering with other competitors.
- Each missed target will result in a one-minute penalty.
- A one-minute penalty will be issued for each safety infraction, to include:
 - not keeping control of the cadet air rifle;
 - moving forward of the firing point; and
 - intentionally firing rounds at objects other than the BART.

OUT OF BOUNDS AREA

Out of bounds areas are to be clearly identified prior to the start of the recreational summer biathlon activity.

NOTES

- Course control staff will record each time a cadet runs through a loop. See course control sheet located at Attachment B.
- The start and finish line chief will keep records for each cadet. When the sheet is full or nearly full the runner will take the sheet to the chief of statistics. See score sheet located at Attachment B.
- Bibs may be used to identify cadets, if available.

COURSE CONTROL SHEET

Cadet Name	Loop 1 Verification	Loop 2 Verification	Loop 3 Verification

Note. Created by D Cdts 3, 2006, Ottawa, ON: Department of National Defence.

Figure B-1 Course Control Sheet

SCORE SHEET

Cadet Name	Start Time	Loop One	Loop Two	Loop Three	End Time	Run / Safety Penalties	Firing Penalties	Total Time

NOTE:
The start and finish line chief is responsible for recording the run times and presenting the score sheet(s) to the scorekeeper.

RANGE RECORDING SHEET

Scorekeeper's Name: _____

Cadet Name:	Lane	Shots Fired	X = Miss	Misses	Comments / Penalties
		3 Spare	○ ○ ○ ○ ○		
Cadet Name:	Lane	Shots Fired	X = Miss	Misses	
		3 Spare	○ ○ ○ ○ ○		
Cadet Name:	Lane	Shots Fired	X = Miss	Misses	
		3 Spare	○ ○ ○ ○ ○		
Cadet Name:	Lane	Shots Fired	X = Miss	Misses	
		3 Spare	○ ○ ○ ○ ○		
Cadet Name:	Lane	Shots Fired	X = Miss	Misses	
		3 Spare	○ ○ ○ ○ ○		
Cadet Name:	Lane	Shots Fired	X = Miss	Misses	
		3 Spare	○ ○ ○ ○ ○		
Cadet Name:	Lane	Shots Fired	X = Miss	Misses	
		3 Spare	○ ○ ○ ○ ○		
Cadet Name:	Lane	Shots Fired	X = Miss	Misses	
		3 Spare	○ ○ ○ ○ ○		

THIS PAGE INTENTIONALLY LEFT BLANK

CHAPTER 10

PO X20 – PARTICIPATE IN CAF FAMILIARIZATION ACTIVITIES



**COMMON TRAINING
ALL TRAINING LEVELS
INSTRUCTIONAL GUIDE
CANADIAN ARMED FORCES
(CAF) FAMILIARIZATION**



SECTION 1

EO MX20.01A – PARTICIPATE IN A CAF ACTIVITY

Total Time:

One session (3 periods) = 90 min

**THERE IS NO INSTRUCTIONAL GUIDE PROVIDED FOR THIS EO. REFER TO
THE LESSON SPECIFICATION LOCATED IN A-CR-CCP-701/PG-001, ROYAL
CANADIAN ARMY CADETS GREEN STAR QUALIFICATION STANDARD AND PLAN.**

THIS PAGE INTENTIONALLY LEFT BLANK



**COMMON TRAINING
ALL TRAINING LEVELS
INSTRUCTIONAL GUIDE
CANADIAN ARMED FORCES
(CAF) FAMILIARIZATION**



SECTION 2

EO MX20.01B – PARTICIPATE IN A CAF FAMILIARIZATION TOUR

Total Time:

One session (3 periods) = 90 min

**THERE IS NO INSTRUCTIONAL GUIDE PROVIDED FOR THIS EO. REFER TO
THE LESSON SPECIFICATION LOCATED IN A-CR-CCP-701/PG-001, ROYAL
CANADIAN ARMY CADETS GREEN STAR QUALIFICATION STANDARD AND PLAN.**

THIS PAGE INTENTIONALLY LEFT BLANK



**COMMON TRAINING
ALL TRAINING LEVELS
INSTRUCTIONAL GUIDE
CANADIAN ARMED FORCES
(CAF) FAMILIARIZATION**



SECTION 3

EO MX20.01C – FIRE THE C7 RIFLE

Total Time:

320 min

PREPARATION

PRE-LESSON INSTRUCTIONS

Resources needed for the delivery of this lesson are listed in the lesson specification located in A-CR-CCP-701/PG-001, *Royal Canadian Army Cadets Green Star Qualification Standard and Plan*, Chapter 4. Specific uses for said resources are identified throughout the instructional guide within the TP for which they are required.

Review the lesson content and become familiar with the material prior to delivering the lesson.

Photocopy the C7 Rifle Handing Test located at Attachment A for each cadet.

Assistant instructors are required for this lesson.

PRE-LESSON ASSIGNMENT

Nil.

APPROACH

An interactive lecture was chosen for TPs 1–3 to present background information and give direction on procedures.

A demonstration and performance was chosen for TPs 4 and 7–12 as it allows the instructor to explain and demonstrate how to complete a safety check and the actions in response to range commands while providing an opportunity for the cadet to practice under supervision.

A performance was chosen for TP 5 as it allows the cadet to practice handling the C7 rifle in a controlled environment.

A demonstration was chosen for TPs 6 and 14–16 as it allows the instructor to explain and demonstrate aiming a C7 rifle as well as the procedures required for stripping, cleaning and assembling the C7 rifle.

A practical activity was chosen for TPs 13 and 17 as it is an interactive way for the cadet to practice and experience range procedures and develop marksmanship skills and knowledge in a safe and controlled environment.

INTRODUCTION

REVIEW

Nil.

OBJECTIVES

By the end of this lesson the cadet shall have fired the C7 rifle.

IMPORTANCE

It is important for cadets to complete a variety of training on the C7 rifle before firing it. Safety precautions are essential to ensure all participants are safe when on a range. Being safe is the highest priority when firing the C7 rifle. Learning and practicing range commands will increase the level of safety on the range and will help ensure that all the cadets have a positive firing experience. Each cadet who fires the C7 rifle must understand the steps for every range command, as well as what to do on the firing point if the rifle does not fire. Knowing how to clean the C7 rifle will ensure that the rifle will continue to operate effectively. Before cleaning the rifle, it must be stripped to provide access to all the parts. After cleaning the rifle, it must be put back together and then tested to ensure it functions properly. This knowledge will ensure the familiarization fire is conducted safely and efficiently.



Strict emphasis must be placed on safety throughout all C7 rifle training. Any cadet who does not adhere to the rules and regulations shall not fire the C7 rifle.

Teaching Point 1

Explain safety rules and regulations pertaining to the C7 rifle.

Time: 5 min

Method: Interactive Lecture

The following are safety rules and regulations pertaining to the C7 rifle:

- Always complete a safety check when picking up or being handed a rifle.
- Always control the rifle when holding it.
- Always treat the rifle as if it were loaded.
- Always have the fire control selector set to 'S' (safe) when the rifle is cocked.
- Never touch the trigger unless firing on a range.

CONFIRMATION OF TEACHING POINT 1

QUESTIONS:

- Q1. When are safety checks completed?
- Q2. Where is the fire control selector set when the rifle is cocked?
- Q3. When will the trigger be touched?

ANTICIPATED ANSWERS:

- A1. When picking up or being handed a rifle.
- A2. 'S' (safe).
- A3. Only when firing on a range.

Teaching Point 2

Identify the parts of the C7 rifle.

Time: 10 min

Method: Interactive Lecture



When identifying the parts of the C7 rifle, keep the cadets involved by pointing at each part as it is discussed.



The upper and lower receiver groups can be separated by removing the takedown pin.

PARTS OF THE C7 RIFLE

The C7 rifle can be separated into two parts. There are two pins that hold the rifle together—the takedown pin and the receiver pivot pin. Both pins separate the upper receiver group from the lower receiver group. When stripping the rifle, the takedown pin will be used. Cadets will rarely be required to use the receiver pivot pin.

Upper Receiver Group

The upper receiver group is comprised of the following:

- **Upper Receiver**
 - **Carrying handle.** A carrying handle which incorporates the rear sight and is attached to the top of the upper receiver.
 - **Ejection port.** Rounds are expelled from the rifle through the ejection port on the right side of the upper receiver.
 - **Ejection port cover.** The ejection port is protected by a dust cover which is opened by the forward / rearward movement of the bolt.
 - **Spent casing deflector.** To the rear of the ejection port cover is a spent casing deflector for those who are left-handed firers.
 - **Forward assist.** A manually-operated forward assist fitted on the right rear of the upper receiver is always used to push the bolt fully forward.
 - **Front and rear sights.** The sights, when used together, assist the firer when aiming the rifle.
- **Barrel**
 - **Flash suppressor.** The rifle is fitted with a flash suppressor that directs hot gas from the barrel end. It also reduces the visibility of the muzzle flash when firing.
 - **Hand guards.** Surrounded by two interchangeable aluminum-lined, glass fibre filled nylon hand guards are notched to allow air to circulate.
- **Bolt and cocking handle.** The bolt is operated by the cocking handle located at the top rear of the upper receiver group. The bolt has a rotating head which locks into the barrel when the rifle is to be fired.

Lower Receiver Group

The lower receiver group is comprised of the following:

- **Lower Receiver**
 - **Trigger.** Also referred to as the action, the trigger is used to fire the rifle. The finger shall never be placed on the trigger unless firing.
 - **Trigger guard.** A safety measure to prevent accidental firing that makes access to the trigger more difficult.
 - **Pistol grip.** The firing hand will hold the pistol grip. The pistol grip provides stability when using the rifle.
 - **Fire control selector.** A three-position fire control selector lever is located on the left side. The three positions are 'S' (safe), 'R' (repetition) and 'AUTO' (automatic). The selector lever cannot be placed on 'S' until the rifle is cocked.
 - **Bolt catch.** A bolt catch, located on the left side, enables the bolt to be held open or released from the open position.
 - **Magazine.** The magazine holds rounds to be fired. When the magazine is not fitted on the rifle, the area is referred to as the magazine housing or magazine opening.

- **Magazine release.** A magazine release button allows for the magazine to be removed from the rifle when activated. It is located on the right side.
- **Butt and butt plate.** The butt is made of glass fibre reinforced nylon and incorporates a storage compartment for a cleaning kit. Access to this compartment is gained through the butt plate. The butt is available in two lengths—normal and short.



Note. Created by Director Cadets 3, 2008, Ottawa, ON: Department of National Defence.

Figure 1 Right Side of the C7 Rifle

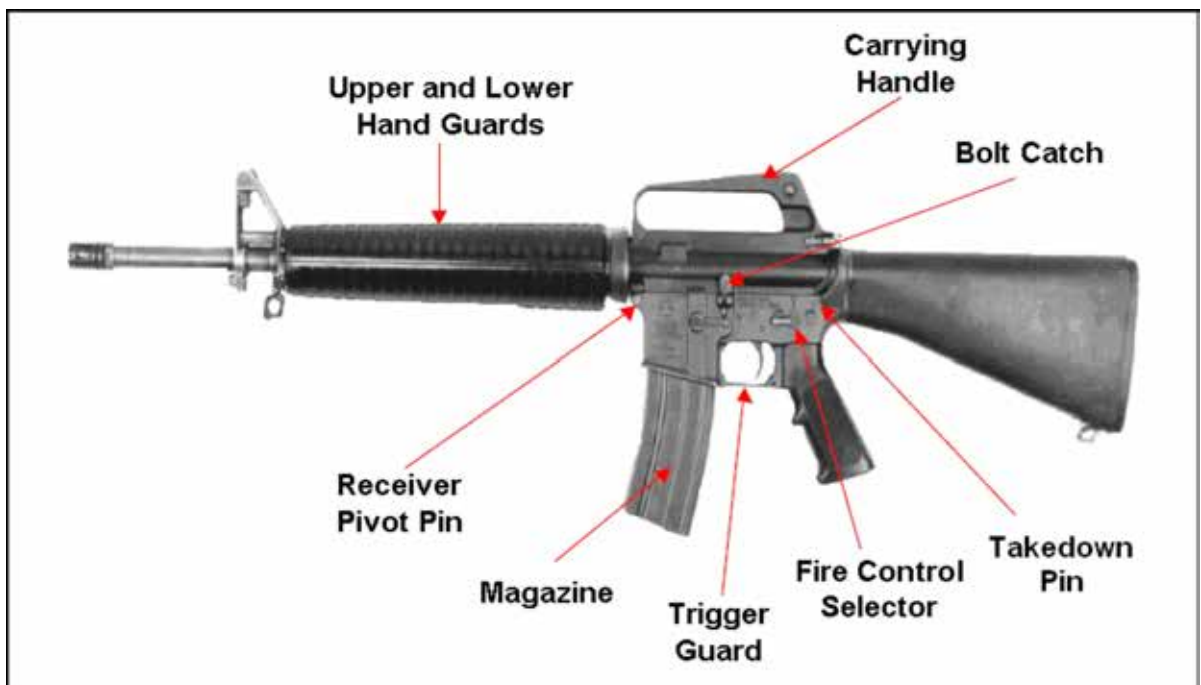

Note. Created by Director Cadets 3, 2008, Ottawa, ON: Department of National Defence.

Figure 2 Left Side of the C7 Rifle

CONFIRMATION OF TEACHING POINT 2

QUESTIONS:

- Q1. What are the two receiver groups on the C7 rifle?
- Q2. What parts are located in the upper receiver?
- Q3. What parts are located in the lower receiver?

ANTICIPATED ANSWERS:

- A1. Upper and lower receiver groups.
- A2. Carrying handle, rear sight, ejection port, ejection port cover, spent casing deflector, forward assist and front and rear sights.
- A3. Trigger, pistol grip, magazine opening, fire control selector, bolt catch and magazine release.

Teaching Point 3

Explain the characteristics of the C7 rifle.

Time: 5 min

Method: Interactive Lecture

CHARACTERISTICS OF THE C7 RIFLE

Calibre. 5.56 mm.

Weight. The rifle weighs 3.34 kg (7.36 pounds). When fully loaded it weighs 3.89 kg (8.58 pounds).

Length. The complete rifle is 1 m in length.

Modes of fire. It can be fired in repetition or automatic.

Operation. It is gas operated, air cooled and magazine fed.

Effective range. It is effective up to 400 m.

Sights. There are front and rear sights. The rear sight has small and large apertures. The large aperture is used for firing at distances less than 300 m. The small aperture is used for distances greater than 300 m.

Magazine capacity. One magazine can hold up to 30 rounds.

CONFIRMATION OF TEACHING POINT 3

QUESTIONS:

- Q1. What is the calibre of the C7 rifle?
- Q2. How long is the C7 rifle?
- Q3. How many rounds can one magazine hold?

ANTICIPATED ANSWERS:

- A1. 5.56 mm.
- A2. 1 m.

A3. 30 rounds.

Teaching Point 4

Explain, demonstrate and have the cadet practice completing an individual safety check.

Time: 15 min

Method: Demonstration and Performance



For this skill TP it is recommended that instruction take the following format:

1. Explain and demonstrate the actions to take to complete a safety check.
2. Explain and demonstrate each step required to complete the skill. Monitor the cadets as they imitate each step.
3. Monitor the cadets' performance as they practice the complete skill.

Note: Assistant instructors may be used to monitor the cadets' performance.



Stress the importance of regularly completing safety checks on the C7 rifle.

Each cadet must complete a safety check during this TP.

INDIVIDUAL SAFETY CHECK

Safety checks shall be completed in the following circumstances:

- when picking up or being handed a rifle;
- before and after instruction;
- before stripping a rifle;
- during issue and return to stores;
- before and after range practices; and
- where there is doubt about the safety status of the rifle.

To complete an individual safety check:



When completing a safety check on the rifle with a magazine fitted, remove the magazine before adopting the standing load position.



If completing a safety check in the prone position, skip Step 1.

1. Adopt the standing load position (as illustrated in Figure 3) by:
 - (a) holding the rifle on the right (left) side of the body by the pistol grip with the forefinger of the right (left) hand outside the trigger guard;
 - (b) grasping the bottom of the hand guard with the left (right) hand;

- (c) placing the left (right) foot one pace in front of the other foot; and
 - (d) pointing the rifle up approximately 55 degrees.
2. Pull the cocking handle to the rear.
 3. Engage the bolt catch.
 4. Tilt the rifle.
 5. Inspect the chamber.
 6. Ensure the rifle is clear.
 7. Pull the cocking handle fully to the rear.
 8. Allow the action to go forward under control.
 9. Strike the forward assist.
 10. Fire the rifle.
 11. Close the ejection port cover.
 12. Lay down the rifle with the ejection port cover facing up.



Note. Created by Director Cadets 3, 2008, Ottawa, ON: Department of National Defence.

Figure 3 Standing Load Position—Example 1



Note. Created by Director Cadets 3, 2008, Ottawa, ON: Department of National Defence.

Figure 4 Standing Load Position—Example 2

CONFIRMATION OF TEACHING POINT 4

QUESTIONS:

- Q1. When must safety checks be completed?
- Q2. After inspecting the chamber and allowing the action to go forward, what is the next step?
- Q3. When laying down the rifle, which side will face up?

ANTICIPATED ANSWERS:

- A1. Safety checks shall be completed in the following circumstances:
- when picking up or being handed a rifle;
 - before and after instruction;
 - before stripping a rifle;
 - during issue and return to stores;
 - before and after range practices; and
 - when the safety status of the rifle is in doubt.

A2. Strike the forward assist.

A3. The side with the ejection port cover.

Teaching Point 5

Have the cadet practice holding the C7 rifle in the prone position.

Time: 5 min

Method: Performance



The cadets have already been instructed on how to adopt the prone position. Emphasis should be placed on holding the C7 rifle.

Information on the prone position is located in A-CR-CCP-701/PG-001, *Green Star Qualification Standard and Plan*, EO M106.03 (Apply Basic Marksmanship Techniques).

HOLDING THE C7 RIFLE IN THE PRONE POSITION



Have each cadet hold the C7 rifle in the prone position.

To hold the C7 rifle in the prone position:

1. Adopt the prone position.
2. Pick up the rifle.
3. Place the butt of the rifle into the right (left) shoulder.
4. Place the left (right) hand on the hand guard.
5. Hold the pistol grip with the right (left) hand.
6. Place the right (left) cheek naturally on the butt.
7. Look through the front and rear sights with the aiming eye.



When holding the rifle in the prone position, the finger shall always be placed outside the trigger guard, unless firing.



Note. Created by Director Cadets 3, 2008, Ottawa, ON: Department of National Defence.

Figure 5 Holding the C7 Rifle in the Prone Position (Right-Side View)



Note. Created by Director Cadets 3, 2008, Ottawa, ON: Department of National Defence.

Figure 6 Holding the C7 Rifle in the Prone Position (Left-Side View)



Note. Created by Director Cadets 3, 2008, Ottawa, ON: Department of National Defence.

Figure 7 Holding the C7 Rifle in the Prone Position

CONFIRMATION OF TEACHING POINT 5

The cadets' participation in holding the C7 rifle in the prone position will serve as the confirmation of this TP.

Teaching Point 6

Explain and demonstrate aiming the C7 rifle by looking through the front and rear sights.

Time: 5 min

Method: Demonstration



During TP 8 the cadets will look through the sights and ensure that they are set properly.

AIMING THE C7 RIFLE

There are two sights on the C7 rifle (front and rear). The rear sight has two apertures (small and large) which simply flip from one to the other.



When firing the C7 rifle, the target will be at a distance of 100 m. Therefore, the large aperture should be used.

When lining up the sights, it is important that both the front and rear sights can be seen down range.



Note. From Weapons: The Rifle 5.56 mm and the Carbine 5.56 mm C8 (Vol. 18) (p. 57), by Canadian Forces, 1987, Ottawa, ON: Department of National Defence. Copyright 1994 by Department of National Defence.

Figure 8 Correct Aim Picture

CONFIRMATION OF TEACHING POINT 6

QUESTIONS:

- Q1. How many sights does the C7 rifle have?
- Q2. How many apertures does the rear sight have?
- Q3. Which aperture should be used when firing at a distance of 100 m?

ANTICIPATED ANSWERS:

- A1. Two—front and rear.
- A2. Two—large and small.
- A3. The large aperture.

Teaching Point 7

Explain, demonstrate and have the cadet practice the actions when given the command LOAD.

Time: 10 min

Method: Demonstration and Performance



For this skill TP it is recommended that instruction take the following format:

1. Explain and demonstrate the actions to take when given the command LOAD.
2. Explain and demonstrate each step required to complete the skill. Monitor the cadets as they imitate each step.
3. Monitor the cadets' performance as they practice the complete skill.

Note: Assistant instructors may be used to monitor the cadets' performance.



Ensure the cadets are aware of the differences between live and dummy rounds. Dummy rounds will be used throughout C7 rifle training.

LOAD

On the command LOAD, the cadet shall do the following:

1. Pick up a magazine.
2. Check to see that the rounds are positioned correctly.



When looking to see if rounds are positioned correctly, simply ensure that they are straight and that the back of each round that is visible is straight against the back of the magazine. When rounds are not positioned correctly, they cause frequent stoppages.

3. Push the magazine firmly into the magazine housing.
4. Check that the magazine is secure by pulling downwards.
5. Return the hand to hold the rifle.

CONFIRMATION OF TEACHING POINT 7

The cadets' participation in practicing actions when given the command LOAD will serve as the confirmation of this TP.

Teaching Point 8

Explain, demonstrate and have the cadet practice the actions when given the command READY or RANGE.

Time: 5 min

Method: Demonstration and Performance



For this skill TP it is recommended that instruction take the following format:

1. Explain and demonstrate the actions to take when given the command READY or RANGE.
2. Explain and demonstrate each step required to complete the skill. Monitor the cadets as they imitate each step.
3. Monitor the cadets' performance as they practice the complete skill.

Note: Assistant instructors may be used to monitor the cadets' performance.

READY OR RANGE

On the command READY or RANGE, the cadet shall do the following:

1. Check the front and rear sights to ensure they are set correctly.
2. Cock the rifle.



When cocking the rifle, ensure the cadets pull the cocking handle all the way back and then let it go. Not doing so is referred to as "riding the cocking handle" since it is rode back into its position. Riding the cocking handle may cause stoppages.

3. Strike the forward assist.
4. Close the ejection port cover.
5. Ensure the fire control selector is on 'S' (safe).
6. Return the hand to hold the rifle.

CONFIRMATION OF TEACHING POINT 8

The cadets' participation in practicing actions when given the command READY or RANGE will serve as the confirmation of this TP.

Teaching Point 9

Explain, demonstrate and have the cadet practice the actions when given the command FIRE.

Time: 5 min

Method: Demonstration and Performance



For this skill TP it is recommended that instruction take the following format:

1. Explain and demonstrate the actions to take when given the command FIRE.
2. Explain and demonstrate each step required to complete the skill. Monitor the cadets as they imitate each step.
3. Monitor the cadets' performance as they practice the complete skill.

Note: Assistant instructors may be used to monitor the cadets' performance.

FIRE

On the command FIRE, the cadet shall do the following:

1. Set the fire control selector to 'R' (repetition).



IAW CATO 14-41, *Use of C7/8 Within the CCO*, Annex A, Appendix 3, cadets are NOT to fire on automatic.

2. Fire all rounds in the magazine.
3. Change magazines as required.



When all rounds have been fired, the bolt will remain at the rear of the rifle. To change a magazine:

1. Remove the old magazine using the magazine release.
2. Pick up a new magazine.
3. Check to see that the rounds are positioned correctly.
4. Push the magazine firmly into the magazine housing.
5. Check that the magazine is secure by pulling downwards.
6. Disengage the bolt catch.
7. Strike the forward assist.
8. Continue firing.



Ensure the cadets are aware that when on the range they may rest the rifle after they have finished firing and then wait for further commands.

CONFIRMATION OF TEACHING POINT 9

The cadets' participation in practicing actions when given the command FIRE will serve as the confirmation of this TP.

Teaching Point 10

Explain, demonstrate and have the cadet practice the actions when given the command UNLOAD.

Time: 10 min

Method: Demonstration and Performance



For this skill TP it is recommended that instruction take the following format:

1. Explain and demonstrate the actions to take when given the command UNLOAD.
2. Explain and demonstrate each step required to complete the skill. Monitor the cadets as they imitate each step.
3. Monitor the cadets' performance as they practice the complete skill.

Note: Assistant instructors may be used to monitor the cadets' performance.

UNLOAD

On the command UNLOAD, the cadet shall do the following:

1. Set the fire control selector to 'S' (safe).
2. Remove the magazine.

3. Cock the rifle twice.
4. Pull the cocking handle to the rear.
5. Engage the bolt catch.
6. Tilt the rifle to the left.
7. Wait to be cleared by the Range Safety Officer (RSO).
8. Receive the command CLEAR from the RSO.
9. Disengage the bolt catch.
10. Strike the forward assist.
11. Set the fire control selector to 'R' (repetition).
12. Fire the rifle.
13. Close the ejection port cover.
14. Lay down the rifle.



Some RSOs may use PREPARE FOR INSPECTION as a separate command after UNLOAD.

CONFIRMATION OF TEACHING POINT 10

The cadets' participation in practicing actions when given the command UNLOAD will serve as the confirmation of this TP.

Teaching Point 11

Explain, demonstrate and have the cadet practice the actions when given the command CEASE FIRE.

Time: 5 min

Method: Demonstration and Performance



For this skill TP it is recommended that instruction take the following format:

1. Explain and demonstrate the actions to take when given the command CEASE FIRE. .
2. Explain and demonstrate each step required to complete the skill. Monitor the cadets as they imitate each step.
3. Monitor the cadets' performance as they practice the complete skill.

Note: Assistant instructors may be used to monitor the cadets' performance.

CEASE FIRE

On the command CEASE FIRE, the cadet shall do the following:

1. Set the fire control selector to 'S' (safe).
2. Wait for a further command.

CONFIRMATION OF TEACHING POINT 11

The cadets' participation in practicing actions when given the command CEASE FIRE will serve as the confirmation of this TP.

Teaching Point 12

Explain, demonstrate and have the cadet practice immediate actions.

Time: 15 min

Method: Demonstration and Performance



For this skill TP it is recommended that instruction take the following format:

1. Explain and demonstrate the first immediate action.
2. Explain and demonstrate each step required to complete the skill. Monitor the cadets as they imitate each step.
3. Monitor the cadets' performance as they practice the complete skill.
4. Repeat Steps 1–3 for the next two immediate actions.

Note: Assistant instructors may be used to monitor the cadets' performance.

IMMEDIATE ACTIONS

Immediate actions are stoppages that occur when the rifle suddenly does not fire anymore. The actions to take are completely dependent on the position of the bolt. The first step to take when the rifle stops firing is to cant the rifle and look through the ejection port. The bolt will either be:

- at the rear,
- fully forward, or
- partially forward.



When the rifle stops firing the first step is to cant the rifle and examine the bolt position.

Bolt is at the Rear

When the rifle stops firing and the bolt is positioned at the rear, most likely the magazine is empty.

When the bolt is at the rear, the cadet shall do the following:

1. Check for an empty magazine and change, as required.
2. Disengage the bolt catch.
3. Strike the forward assist.
4. Continue firing.

Bolt is Fully Forward

When the rifle stops firing and the bolt is positioned fully forward, most likely the bolt did not pick up a round. This could be caused by an improperly seated magazine.

When the bolt is fully forward, the cadet shall do the following:

1. Ensure the magazine is seated properly and locked in place.
2. Cock the rifle while watching for a round or empty casing to eject.
3. Where a round ejects:
 - (a) strike the forward assist; and
 - (b) continue firing.
4. Where a round does not eject:
 - (a) attempt to continue firing; and
 - (b) if required, request assistance.

Bolt is Partially Forward

When the rifle stops firing and the bolt is positioned partially forward, most likely there is an obstruction.

When the bolt is partially forward, the cadet shall do the following:

1. Cock the rifle.
2. Engage the bolt catch.
3. Examine the chamber of the rifle.
4. Remove the magazine if a live round or empty casing is in the chamber.
5. Clear the obstruction.
6. Replace the magazine.
7. Disengage the bolt catch.
8. Strike the forward assist.
9. Continue firing.



When in doubt, raise your hand and ask for assistance.

CONFIRMATION OF TEACHING POINT 12

The cadets' participation in practicing immediate actions will serve as the confirmation of this TP.

Teaching Point 13**Have the cadet participate in a mock range activity.**

Time: 30 min

Method: Practical Activity



Begin the handling test located at Attachment A during this TP. Where extra time is needed, conduct it at the beginning of TP 17.

Each cadet must successfully complete the handling test in order to fire the C7 rifle.

ACTIVITY**OBJECTIVE**

The objective of this activity is to have the cadets practice performing firing drills and executing range commands.

RESOURCES

- C7 rifles (one per firing point),
- Magazines (minimum two per firing point),
- 5.56-mm dummy rounds (10 per cadet),
- Hearing protectors (one per firing point),
- Shooting mats (one per firing point), and
- C7 handling test located at Attachment A (one per cadet).

ACTIVITY LAYOUT

1. Find a safe area in which eight cadets with rifles can be pointed "down range."
2. Place eight shooting mats on the mock firing point.
3. Lay one rifle on each shooting mat.
4. Lay one pair of hearing protectors and one magazine with five dummy rounds on each shooting mat.

ACTIVITY INSTRUCTIONS

1. Divide the cadets into relays of a maximum of eight.
2. Lead the first relay of cadets through a mock range activity using the following range commands:
 - (a) COVER OFF BEHIND THE FIRING POINT.
 - (b) ADOPT THE PRONE POSITION.
 - (c) PLACE HEARING PROTECTORS ON.
 - (d) PICK UP THE RIFLE.
 - (e) LOAD.
 - (f) RANGE OR READY.

(g) FIRE.



Though there are no range commands for immediate actions, have the cadets complete the actions for them.

One way to do this is:

- Give the command CEASE FIRE.
- Ask the cadets to engage the bolt catch.
- Tell the cadets that they were firing down range and suddenly the rifle stopped.
- Have the cadets complete the immediate action.

(h) Unload.

(i) Prepare for inspection.

(j) Lay down the rifle.

(k) Take off hearing protectors.

(l) Stand up.

(m) Retire from the firing point.

3. Repeat Step 2 until there are no more relays.

4. Complete the handling test, located at Attachment A, as the cadets complete the activity.

SAFETY

- Rifles shall always be pointed "down range".
- The cadets are to follow range rules and regulations throughout the activity.

CONFIRMATION OF TEACHING POINT 13

The cadets' participation in the activity will serve as the confirmation of this TP.

Teaching Point 14

Explain and demonstrate field stripping the C7 rifle.

Time: 5 min

Method: Demonstration



There are two degrees to which the C7 rifle can be stripped—detailed and field. During this training, the cadets will only be required to field strip the rifle.

Explain and demonstrate the process for field stripping a C7 rifle. Ensure all cadets can see the demonstration.

FIELD STRIPPING THE C7 RIFLE

In order to clean the rifle, it must be field stripped. To field strip the C7 rifle:

1. Carry out an individual safety check (without operating the trigger).
2. Ensure the fire control selector is set to 'S' (safe).
3. Unlock the upper receiver by pushing / pulling the takedown pin.
4. Pull the cocking handle partially to the rear.
5. Remove the bolt.
6. Push the cocking handle fully forward.
7. Lay down the rifle.
8. Remove the bolt from the bolt carrier.
9. Lay down the bolt and bolt carrier.

CONFIRMATION OF TEACHING POINT 14

The cadets' participation in field stripping the C7 rifle will serve as the confirmation of this TP.

Teaching Point 15

Explain and demonstrate cleaning the C7 rifle after a range practice.

Time: 5 min

Method: Demonstration



The cleaning kit should contain the following items:

- a case,
- a four-piece rod,
- a swab holder,
- a bore brush,
- a chamber brush,
- a bolt key brush,
- a container of cleaner, lubricant, preservative (CLP),
- pipe cleaners, and
- swabs (38 mm by 50 mm).



There are three types of cleaning—regular, before firing and after firing. The cadets will be required to clean the rifle after firing on the range.

Explain and demonstrate the process for cleaning a C7 rifle. Ensure all cadets can see the demonstration.

CLEANING THE C7 RIFLE

In order for the rifle to remain functional, regular maintenance of the rifle must be carried out regularly.

Chamber

Clean with the chamber brush fitted to the cleaning rod.

Flash Suppressor

Clean using the bore cleaning brush.

Barrel

1. Insert the four-piece rod (about two turns short of being tight) with a swab moistened in CLP into the barrel (a portion should stick out through the muzzle).
2. Replace the swab holder with the bore brush and insert it into the barrel.
3. Repeat several times (rods may have to be loosened).
4. Pull a dry swab through and then pull a swab lightly lubricated with CLP through.

Bolt and Carrier

1. Clean the interior of the bolt key with the bolt key brush then dry using a pipe cleaner.
2. Using a CLP lubricated swab, clean all the parts of the bolt.
3. Lubricate the bolt and bolt carrier.
4. Dry the bolt key and place one drop of CLP inside the tube.

Upper Receiver

1. Clean the external surface with a lubricated CLP swab and a cleaning brush and wipe dry.
2. Clean the exterior of the gas tube that protrudes into the upper receiver using two rod pieces and a bore brush.
3. Use a pipe cleaner to clean as far into the gas tube as possible.
4. Clean the inner surfaces.
5. Lightly lubricate the inside of the upper receiver, outer surface of the barrel, front sight and the surface under the hand guard.
6. Push and pull the front sight and place two or three drops of CLP around the area, working it in.

Lower Receiver

1. Clean the external surface with a lubricated CLP swab and a cleaning brush and wipe dry.
2. Clean the interior, paying special attention to the magazine housing and trigger group.
3. Apply CLP generously to the trigger group, takedown pin and pivot pin.

Butt and Hand Guards

1. Wipe clean the external surfaces.
2. Do not oil the nylon surfaces.



When cleaning before firing, inspect the rifle to determine if it requires cleaning. In most cases, wiping exposed surfaces will be sufficient. If it is necessary to clean the rifle, it should be done the same as regular cleaning except that the bore, face of the bolt and the chamber must be free of lubricant.

CONFIRMATION OF TEACHING POINT 15

The cadets' participation in cleaning the C7 rifle will serve as the confirmation of this TP.

Teaching Point 16

Explain and demonstrate assembling the C7 rifle.

Time: 5 min

Method: Demonstration



Explain and demonstrate the process for assembling a C7 rifle. Ensure all cadets can see the demonstration.

ASSEMBLING THE C7 RIFLE

To assemble the C7 rifle:

1. Replace the bolt in the bolt carrier.
2. Pull the cocking handle partially to the rear.
3. Place the bolt in the rifle.
4. Push the cocking handle fully forward.
5. Ensure the fire control selector is set to 'S' (safe).
6. Lock the upper receiver with the takedown pin.
7. Complete the function test by:
 - (a) cocking the rifle;
 - (b) attempting to fire with the fire control selector at 'S' (safe);
 - (c) setting the fire control selector to 'R' (repetition);
 - (d) firing the action;
 - (e) cocking the action while holding in on the trigger;
 - (f) releasing the trigger (after hearing the hammer fall);
 - (g) firing the action;
 - (h) setting the fire control selector to 'AUTO' (automatic);
 - (i) firing the action;
 - (j) cocking the action while holding in on the trigger;

- (k) releasing the trigger (after hearing the hammer fall);
- (l) returning the fire control selector to 'R' (repetition); and
- (m) closing the ejection port cover.

CONFIRMATION OF TEACHING POINT 16

The cadets' participation in assembling the C7 rifle will serve as the confirmation of this TP.

Teaching Point 17

Have the cadet fire 25 rounds with the C7 rifle.

Time: 170 min

Method: Practical Activity



All familiarization firing must be lead by a Large Bore RSO (RSO [LB]). Consult and adhere to the policies outlined in CATO 14-41, *Use of C7/8 Within the CCO*, Appendix 3, Annex A.

All range activities shall be conducted IAW the Range Standing Orders specific to the area being used.

ACTIVITY

OBJECTIVE

The objective of this activity is to have the cadets fire 25 rounds using the C7 rifle.

RESOURCES

- C7 rifle (one per firing point),
- 5.56-mm ammunition (25 rounds per cadet),
- Magazines (minimum of three per cadet),
- Marksmanship target (one per firing point),
- Target frame (one per firing point),
- Hearing protectors (one per firing point),
- Shooting mats (one per firing point),
- First aid kit (one),
- Stretcher (one),
- Cell phone / radio (one),
- Folding tables (three),
- Empty sandbags (five),
- Green and red flags (two sets),
- Target patches (5 rolls),
- Where butts are being used:
 - helmets (one per person),

- pointers (one per person),
- communication device (two—one for the RSO and one for the butt party);
- Range standing orders (one),
- Cleaning kits (one per four cadets),
- C7 handling test located at Attachment A, if required (one per cadet), and
- Pen / pencil (five).

ACTIVITY LAYOUT

Set up the firing points, targets and butts (if applicable).

ACTIVITY INSTRUCTIONS

1. Brief the cadets on the range activity.



If the cadets are expected to signal in the butts, a briefing shall take place before beginning the activity.

2. Have each cadet complete the C7 rifle handling test, where required.
3. Divide the cadets into relays.
4. Lead the first relay of cadets through the range activity using range commands.



Ensure the cadets are given the opportunity to view their targets at least once throughout the familiarization fire. They may then make adjustments, if desired, to try to improve.

5. Repeat Step 4 until there are no more relays.
6. Have the cadets field strip, clean and assemble the C7 rifle, in groups of four.

SAFETY

- Rifles shall always be pointed down range.
- The cadets are to follow all range rules and regulations throughout the activity.

CONFIRMATION OF TEACHING POINT 17

The cadets' participation in the activity will serve as the confirmation of this TP.

END OF LESSON CONFIRMATION

The cadets' participation in firing the C7 rifle will serve as the confirmation of this lesson.

CONCLUSION

HOMEWORK / READING / PRACTICE

Nil.

METHOD OF EVALUATION

Nil.

CLOSING STATEMENT

It is important for cadets to participate in Canadian Forces (CF) familiarization activities. Firing the C7 rifle is one of the many CF familiarization activities in which cadets can develop a connection to and knowledge about the CF.

INSTRUCTOR NOTES / REMARKS

Each cadet must successfully complete the C7 Rifle Handling Test (located at Attachment A) prior to firing the rifle.

The cleaning kit contains the following:

- a case,
- a four-piece rod,
- a swab holder,
- a bore brush,
- a chamber brush,
- a bolt key brush,
- a container of cleaner, lubricant, preservative (CLP),
- pipe cleaners, and
- swabs (38-mm by 50-mm).

All familiarization firing must be led by a Range Safety Officer (Large Bore - C7). Consult and adhere to the policies outlined in CATO 14-41 *Use of C7/8 Within the CCO*, Appendix 3, Annex A.

The firing shall be familiarization and shall include an inspection of targets at least once throughout the 25 rounds to allow the cadets to make adjustments if inclined to do so.

Where butts are being used, time shall be spent instructing the cadets on their operation.

Assistant instructors are required for this lesson.

REFERENCES

A2-062 B-GL-317-018/PT-001 Canadian Forces. (1987). *Weapons: The rifle 5.56 mm C7 and the carbine 5.56 mm C8* (Vol. 18). Ottawa, ON: Department of National Defence.

THIS PAGE INTENTIONALLY LEFT BLANK

C7 RIFLE HANDLING TEST

Cadet Name: _____

Platoon: _____

SAFETY PRECAUTIONS

ACTION TO BE CARRIED OUT BY THE CADET	ACTION COMPLETED	
1. Adopt the standing load position (if required).	YES	NO
2. Pull the cocking handle to the rear and engage the bolt catch.	YES	NO
3. Tilt the rifle and inspect the chamber.	YES	NO
4. Ensure the rifle is clear.	YES	NO
5. Pull the cocking handle fully to the rear.	YES	NO
6. Allow the action to go forward under control and strike the forward assist.	YES	NO
7. Fire the rifle.	YES	NO
8. Close the ejection port cover.	YES	NO
9. Lay down the rifle with the ejection port cover facing up.	YES	NO

LOAD

ACTION TO BE CARRIED OUT BY THE CADET	ACTION COMPLETED	
1. Pick up a magazine.	YES	NO
2. Check to see if the rounds are positioned correctly.	YES	NO
3. Push the magazine firmly into the magazine housing.	YES	NO
4. Check that the magazine is secure by pulling downwards.	YES	NO
5. Return the hand to hold the rifle.	YES	NO

READY OR RANGE

ACTION TO BE CARRIED OUT BY THE CADET	ACTION COMPLETED	
1. Check the front and rear sights to ensure they are set correctly.	YES	NO
2. Cock the rifle.	YES	NO
3. Strike the forward assist.	YES	NO
4. Close the ejection port cover.	YES	NO
5. Ensure the fire control selector is set to 'S' (safe).	YES	NO
6. Return the hand to hold the rifle.	YES	NO

IMMEDIATE ACTION–BOLT AT REAR

"The rifle is firing alright and then suddenly stops."

The cadet shall cant the rifle and examine the bolt position.

"The bolt is fully to the rear."

ACTION TO BE CARRIED OUT BY THE CADET	ACTION COMPLETED	
1. Check for an empty magazine and change.	YES	NO
2. Disengage the bolt catch.	YES	NO
3. Strike the forward assist and continue firing.	YES	NO

IMMEDIATE ACTION–BOLT FULLY FORWARD

"The rifle is firing alright and then suddenly stops."

The cadet shall cant the rifle and examine the bolt position.

"The bolt is fully forward."

ACTION TO BE CARRIED OUT BY THE CADET	ACTION COMPLETED	
1. Ensure the magazine is seated properly and locked in place.	YES	NO
2. Cock the rifle and watch for a round or empty casing to eject.	YES	NO
3. Strike the forward assist and continue firing.	YES	NO

IMMEDIATE ACTION–BOLT PARTIALLY FORWARD

"The rifle is firing alright and then suddenly stops."

The cadet shall cant the rifle and examine the bolt position.

"The bolt is partially forward and there is an obstruction."

ACTION TO BE CARRIED OUT BY THE CADET	ACTION COMPLETED	
1. Cock the rifle and engage the bolt catch.	YES	NO
2. Examine the chamber.	YES	NO
3. Remove the magazine if a live round or empty casing is in the chamber.	YES	NO
4. Clear the obstruction.	YES	NO
5. Replace the magazine.	YES	NO
6. Disengage the bolt catch.	YES	NO
7. Strike the forward assist and continue firing.	YES	NO

UNLOAD

ACTION TO BE CARRIED OUT BY THE CADET		ACTION COMPLETED	
1.	Set the fire control selector to 'S' (safe).	YES	NO
2.	Remove the magazine.	YES	NO
3.	Cock the rifle twice.	YES	NO
4.	Pull the cocking handle to the rear and engage the bolt catch.	YES	NO
5.	Tilt the rifle to the left and wait to be cleared by the RSO.	YES	NO
6.	Disengage the bolt catch.	YES	NO
7.	Strike the forward assist.	YES	NO
8.	Set the fire control selector to 'R' (repetition).	YES	NO
9.	Fire the rifle.	YES	NO
10.	Close the ejection port cover.	YES	NO
11.	Lay down the rifle.	YES	NO

Comments:

RSO (LB) Signature: _____

THIS PAGE INTENTIONALLY LEFT BLANK



**COMMON TRAINING
ALL TRAINING LEVELS
INSTRUCTIONAL GUIDE
CANADIAN ARMED FORCES
(CAF) FAMILIARIZATION**



SECTION 4

EO MX20.01D – PARTICIPATE IN A MESS DINNER

Total Time:

One session = 90 min

PREPARATION

PRE-LESSON INSTRUCTIONS

This IG supports EO MX20.01D (Participate in a Mess Dinner) located in A-CR-CCP-701/PG-001, *Royal Canadian Army Cadets Green Star Qualification Standard and Plan*, Chapter 4.

One week prior to the mess dinner, photocopy and distribute the appropriate elemental Cadet Mess Dinner pamphlet, located at Annexes A–C, for each cadet.

One week prior to the mess dinner, photocopy and distribute the Role of the President of the Mess Committee (PMC) handout, located at Annex D, to the cadet filling the role of PMC.

One week prior to the mess dinner, photocopy and distribute the Role of the Vice-President of the Mess Committee (VPMC) handout, located at Annex E, to the cadets filling the role of VPMC.

Refer to the Organize a Mess Dinner Aide-Memoire located at Annex F to guide the preparation of the mess dinner.

Brief the cadets on the expected dress for the mess dinner.

PRE-LESSON ASSIGNMENT

Have the cadets read the applicable Cadet Mess Dinner pamphlet in preparation for the mess dinner.

APPROACH

A practical activity was chosen for this lesson as it is an interactive way to allow cadets to experience a mess dinner in a safe, controlled environment. This activity is an interactive way to build on the cadets' knowledge of the CAF.

INTRODUCTION

REVIEW

Nil.

OBJECTIVES

By the end of this session the cadets shall have participated in a mess dinner.

IMPORTANCE

The mess dinner is a ceremonial occasion when military personnel dine together formally and is one of the most important traditions of the CAF. Historically, military organizations have taken on a life and routine based upon discipline, order, and traditions that differ from civilian life. This boosts morale and develops esprit de corps.

ACTIVITY



The protocols and procedures for a Mess Dinner must be adapted to fit the regulations of the Cadet Program. While the tradition in the CAF calls for the serving of alcohol, IAW CATO 13-23, *Drug and Alcohol Policy*, cadets will not be served alcohol. Grape juice may be substituted for port during a cadet mess dinner.

1. Conduct a mess dinner, to include:
 - (a) pre-dinner gathering,
 - (b) mess calls,
 - (c) arrival of the head table,
 - (d) dinner,
 - (e) passing of the port,
 - (f) loyal toast,
 - (g) marches,
 - (h) speeches, and
 - (i) departure of the head table.
2. Have the cadets sign a guest book reflecting on their experience.

CONCLUSION

METHOD OF EVALUATION

Nil.

CLOSING STATEMENT

Participating in a mess dinner has allowed you to experience CAF customs, traditions, and rituals. Mess dinners are happy occasions that allow all members, regardless of rank, to meet on an occasion where good manners are expected.

INSTRUCTOR NOTES / REMARKS

There are numerous leadership opportunities for cadets when conducting a mess dinner:

- Phase Five / Master Cadet / Proficiency Level Five cadets may plan, prepare and conduct the mess dinner as a leadership project IAW PO 503 (Lead Cadet Activities); and
- Phase Three / Silver Star / Proficiency Level Three, Phase Four / Gold Star / Proficiency Level Four, and Phase Five / Master Cadet / Proficiency Levels Five cadets may complete leadership assignments

such as acting as the Mess President and the Mess Vice-Presidents IAW POs 303 (Perform the Role of a Team Leader), 403 (Act as a Team Leader), and 503 (Lead Cadet Activities).

The organization of the mess dinner shall be based on human and material resources available to the corps / squadron.

REFERENCES

A-CR-050-801/PH-001 Directorate of Cadets 6. (2009). *Training plan DP1 Cadet Instructors Cadre: Basic Officer Training Course*. Ottawa, ON: Department of National Defence.

A-AD-200-000/AG-000 Director Honours and Recognition. (1999). *The honours, flags and heritage structure of Canadian Forces*. Ottawa, ON: Department of National Defence.

A-AD-262-000/AG-000 Director of Physical Education, Recreation and Amenities. (1984). *Mess administration*. Ottawa, ON: Department of National Defence.

CFACM 1-900 Air Command. (2007). *Air command mess dinner procedures*. Ottawa, ON: Department of National Defence.

HMCS Queen Regina's Naval Reserve Division. (2009). *Chief Petty Officers & Petty Officers mess dinner naval customs*. Retrieved April 28, 2009, from <http://www.hmcsqueen.ca/cpomessdinner.pdf>.

Love, D.W. (1990). *Manual of Canadian naval etiquette*. Victoria, BC: VENTURE, The Naval Officer Training Centre.

ReadyAyeReady (2009). *Naval Toasts of the Day – Customs and Traditions: Naval toasts of the day*. Retrieved April 1, 2009 from <http://www.readyayeready.com/tradition/naval-toasts-of-theday.htm>

THIS PAGE INTENTIONALLY LEFT BLANK

Rules of Order

The rap of the gavel for grace signals the official start of dinner. Between then and the toast of the day, the following rules of order are in force:

No one may come in and sit down at the table, leave the table, read (except the menu and musical program), or send or receive messages.

Whenever the PMC or VPMC taps the table, there must be silence until they have finished speaking.

Requests are made via the VPMC. When a diner is coming to the table late, or is returning after leaving, the PMC's permission must be given.

There are no ranks or titles in the mess. All members present address each other as: Mister, Miss, or Missus. Only the PMC and VPMC will be addressed by title.

No member shall engage in conversation with the Head Table or the opposite table. Members shall only converse with those across, beside, and diagonal from themselves.

No diner may begin a course before the PMC, use foul language, discuss political or other controversial subjects, talk about work, speak in a foreign language (except when foreign guests are present) or tell rude or insulting jokes.

Members shall not clap. Instead diners shall rap the table lightly to express their opinion and solicitations.

Members shall not propose a toast (this includes "cheers" or similar remarks or raising a glass in greeting).

Mess Dinner Program

Before Dinner Gathering

Mess Call

Arrival of the Head Table

Dinner Course

Passing the Port

Toasts

Marches

~ Break ~

Coffee / Dessert

Speeches

Departure of the Head Table



Sea Cadet Mess Dinner

The mess dinner is a ceremonial occasion when military personnel dine together formally and is one of the most important traditions of the Canadian Armed Forces (CAF). In addition to educating cadets about an important CAF tradition, the mess dinner is also relevant because the basic rules of conduct observed are those of polite society.

Before Dinner Gathering

Cadets and guests are invited to arrive a half hour before the set time for dinner. During this period, members consult the seating plan and meet the guest of honour. During the gathering, all members pay their respects to the guest of honour providing this can be done without undue interruption to conversation with senior guests.

Introductions

All guests should be introduced to as many of the other members present as feasible. When introducing oneself it is customary to say, "Mr. Bloggins, I would like to introduce myself. I am ____". If you don't know to whom you are speaking, it is customary to say, "Please let me introduce myself. My name is ____".

Mess Calls

A bugler sounds a call at 15 minutes prior to dinner. This alerts guests to prepare to move to the dining room and to use the washroom before the start of the mess dinner. In the absence of a bugler, the mess call may be verbal.

Seating Plans

A Mess Dinner seating plan is formally arranged and the plan is drawn up and displayed. Individual places are marked with a name card. Members must sit in their assigned seat; shifting of places is not permitted.

Marching In

Five minutes prior to the meal time the senior steward enters the anteroom and reports to the PMC, "Dinner is served, Sir/Ma'am". Members move to their assigned seat and stand behind their chair. When all members are in place, the PMC and guest of honour make their way into the dining room. If a band is present, they may play "*The Roast Beef of Olde England*". No one may take their seats before the PMC.

Grace

When all diners are seated the PMC raps the table for silence with a gavel. The PMC requests a member of the mess to say grace. If a Chaplain is present, they would give the grace.

Passing the Port

In a naval mess, the decanters should be slid to the left and never leave the table. Passing the port along the table was implemented for practical reasons, as lifting a heavy decanter off a table in a moving ship might mean the table coming up quickly under the decanter and potentially spilling the port.

Loyal Toast

The PMC calls upon the VPMC to toast the Queen of Canada. For example, they may say, "Mr. Vice, The Queen of Canada", or "Monsieur le vice-president, La Reine du Canada". The VPMC announces, in the other official language, "Ladies and gentlemen, The Queen of Canada" or, "Mesdames et messieurs, La Reine du Canada". Diners announce individually "The Queen / La Reine" and take the Loyal Toast. In the navy, the Loyal Toast is given seated.

Naval members **never** clink glasses during any toast or greeting. This custom comes from the old belief that "a glass that rings tolls the death of a sailor". Instead, a sailor forwards the back of their hand with the glass in it.

Toast of the Day

Following the loyal toast the President will call upon a member to give the toast of the day.

Monday -	Our Ships	Friday -	Our Nation
Tuesday -	Our Sailors	Saturday -	Our Families
Wednesday -	Ourselves	Sunday -	Absent Friends
Thursday -	Our Navy		

Marches

Following the toasts, "*Heart of Oak*" is played. If any other elements are present, the appropriate march is played. A member only stands at attention for their own march.

Speeches

After the toasts and marches have been completed, the PMC may open the floor to speeches by special guests.

Departing the Dining Room

Upon completion of all mess functions, the PMC shall conclude the mess dinner with a rap of the gavel. All members will stand for the departure of the head table.

Dinner Etiquette

Keep elbows close to the sides at all times and never place them on the table.

Silverware or glasses must not be played with.

Silverware is laid out in the order in which it is to be used; the knives to the right of the plate and the forks to the left.

Bread must be broken with the fingers.

Never speak with food in the mouth or make gestures while utensils are in hands.

Never ask for anything that is not offered on the table such as butter, vinegar, or ketchup.

Tea or coffee should be sipped and the cup is replaced to the saucer between sips.

President of the Mess Committee (PMC)

The PMC is in absolute charge, regardless of rank or seniority. The PMC greets the guest of honour; escorts the guest of honour into the dining room, asks for grace to be said, levies fines against misbehaving members, begins passing the port, gives the loyal toast, dismisses for breaks, introduces the guest of honour; and escorts the guest of honour out of the dining room.

Vice-President of the Mess Committee (VPMC)

The Vice-President assists the President in maintaining order during the Mess Dinner. They direct members to the dining room, pass on messages to the President from members, call the President's attention to any misbehaviour from other tables, begin passing the port, and assist in the Loyal Toast.

Rules of Order

The rap of the gavel for grace signals the official start of dinner. Between then and the loyal toast, the following rules of order are in force:

No one may come in and sit down at the table, leave the table, read (except the menu and musical program), or send or receive messages.

Whenever the PMC or VPMC taps the table, there must be silence until they have finished speaking.

Requests are made via the VPMC. When a diner is coming to the table late, or is returning after leaving, the PMC's permission must be given.

There are no ranks or titles in the mess. All members present address each other as: Mister, Miss, or Missus. Only the PMC and VPMC will be addressed by title.

No member shall engage in conversation with the Head Table or the opposite table. Members shall only converse with those across, beside, and diagonal from themselves.

No diner may begin a course before the PMC, use foul language, discuss political or other controversial subjects, talk about work, speak in a foreign language (except when foreign guests are present) or tell rude or insulting jokes.

Members shall not clap. Instead diners shall rap the table lightly to express their opinion and solicitations.

Members shall not propose a toast (this includes "cheers" or similar remarks or raising a glass in greeting).

Mess Dinner Program

Before Dinner Gathering

Mess Call

Arrival of the Head Table

Dinner Course

Passing the Port

Toasts

Marches

~ Break ~

Coffee / Dessert

Speeches

Departure of the Head Table



Army Cadet Mess Dinner

The mess dinner is a ceremonial occasion when military personnel dine together formally and is one of the most important traditions of the Canadian Armed Forces (CAF). In addition to educating cadets about an important CAF tradition, the mess dinner is also relevant because the basic rules of conduct observed are those of polite society.

Before Dinner Gathering

Cadets and guests are invited to arrive half hour before the set time for dinner. During this period, members consult the seating plan and meet the guest of honour. During the gathering, all members pay their respects to the guest of honour providing this can be done without undue interruption to conversation with senior guests.

Introductions

All guests should be introduced to as many of the other members present as feasible. When introducing oneself it is customary to say, "Mr. Bloggins, I would like to introduce myself. I am ____". If you don't know to whom you are speaking, it is customary to say, "Please let me introduce myself. My name is ____".

Mess Calls

A bugler or piper sounds a call at 15 minutes prior to dinner. This alerts guests to prepare to move to the dining room and to visit the washroom before the start of the mess dinner. In the absence of a bugler or piper, the mess call may be verbal.

Seating Plans

A Mess Dinner seating plan is formally arranged and the plan is drawn up and displayed. Individual places are marked with a name card. Members must sit in their assigned seat; shifting of places is not permitted.

Marching In

Five minutes prior to the meal time the senior steward enters the anteroom and reports to the PMC, "Dinner is served, Sir/Ma'am". Members move to their assigned seat and stand behind their chair. When all members are in place, the PMC and guest of honour make their way into the dining room. If a band is present, they may play "*The Roast Beef of Olde England*". No one may take their seats before the PMC.

Grace

When all diners are seated the PMC raps the table for silence with a gavel. The PMC requests a member of the mess to say grace. If a Chaplain is present, they would give the grace.

Passing the Port

In an army mess, the decanters should be moved to the left and placed soundly on the table by each member. The port should not be placed so soundly as to disturb other items on the table, to cause spillage of the port, or to cause damage.

Loyal Toast

The PMC calls upon the VPMC to toast the Queen of Canada. For example, they may say, "Mr. Vice, The Queen of Canada", or "Monsieur le vice-president, La Reine du Canada". The VPMC announces, in the other official language, "Ladies and gentlemen, The Queen of Canada" or, "Mesdames et messieurs, La Reine du Canada". Diners announce individually "The Queen / La Reine" and take the Loyal Toast. The loyal toast is given while standing.

Marches

Following the toasts, the regimental march past is played. If any other elements are present, the appropriate march is played. A member only stands at attention for their own march.

Speeches

After the toasts and marches have been completed, the PMC may open the floor to speeches by special guests.

Departing the Dining Room

Upon completion of all mess functions, the PMC shall conclude the mess dinner with a rap of the gavel. All members will stand for the departure of the head table.

Dinner Etiquette

Keep elbows close to the sides at all times and never place them on the table.

Silverware or glasses must not be played with.

Silverware is laid out in the order in which it is to be used; the knives to the right of the plate and the forks to the left.

Bread must be broken with the fingers.

Never speak with food in the mouth or make gestures while utensils are in hands.

Never ask for anything that is not offered on the table such as butter, vinegar, or ketchup.

Tea or coffee should be sipped and the cup is replaced to the saucer between sips.

President of the Mess Committee (PMC)

The PMC is in absolute charge, regardless of rank or seniority. The PMC greets the guest of honour; escorts the guest of honour into the dining room, asks for grace to be said, levies fines against misbehaving members, begins passing the port, gives the loyal toast, dismisses for breaks, introduces the guest of honour, and escorts the guest of honour out of the dining room.

Vice-President of the Mess Committee (VPMC)

The Vice-President assists the President in maintaining order during the Mess Dinner. They direct members to the dining room, pass on messages to the President from members, call the President's attention to any misbehaviour from other tables, begin passing the port, and assist in the Loyal Toast.

Rules of Order

The rap of the gavel for grace signals the official start of dinner. Between then and the toast of the day, the following rules of order are in force:

No one may come in and sit down at the table, leave the table, read (except the menu and musical program), or send or receive messages.

Whenever the President or Vice-President taps the table, there must be silence until they have finished speaking.

Request are made via the Vice-President. When a diner is coming to the table late, or is returning after leaving, the President's permission must be given.

There are no ranks or titles in the mess. All members present address each other as: Mister, Miss, or Missus. Only the President and Vice-President will be addressed by title.

No member shall engage in conversation with the Head Table or the opposite table. Members shall only converse with those across, beside, and diagonal from themselves.

No diner may begin a course before the President, use foul language, discuss political or other controversial subjects, talk about work, speak in a foreign language (except when foreign guests are present) or tell rude or insulting jokes.

Members shall not clap. Instead diners shall rap the table lightly to express their opinion and solicitations.

Members shall not propose a toast (this includes "cheers" or similar remarks or raising a glass in greeting).

Mess Dinner Program

Before Dinner Gathering

Mess Call

Arrival of the Head Table

Dinner Course

Passing the Port

Toasts

Marches

~ Break ~

Coffee / Dessert

Speeches

Departure of the Head Table



Air Cadet Mess Dinner

The mess dinner is a ceremonial occasion when military personnel dine together formally and is one of the most important traditions of the Canadian Forces (CAF). In addition to educating cadets about an important CAF tradition, the mess dinner is also relevant because the basic rules of conduct observed are those of polite society.

Before Dinner Gathering

Cadets and guests are invited a half hour before the set time for dinner. During this period, members consult the seating plan and meet the guest of honour. During the gathering, all members pay their respects to the guest of honour providing this can be done without undue interruption to conversation with senior guests.

Introductions

All guests should be introduced by their escorts to as many of the other members present as feasible. When introducing oneself it is customary to say, "Mr. Bloggins, I would like to introduce myself. I am ____". If you don't know to whom you are speaking, it is customary to say, "Please let me introduce myself. My name is ____".

Mess Calls

A bugler or piper sounds a call at 15 minutes prior to dinner. This alerts guests to prepare to move to the dining room and to use the washroom before the start of the mess dinner. In the absence of a bugler or piper, the mess call may be verbal.

Seating Plans

A Mess Dinner seating plan is formally arranged and the plan is drawn up and displayed. Individual places are marked with a name card. Members must sit in their assigned seat; shifting of places is not permitted.

Marching In

Five minutes prior to the meal time the senior steward enters the anteroom and reports to the PMC, "Dinner is served, Sir/Ma'am". Members move to their assigned seat and stand behind their chair. When all members are in place, the PMC and guest of honour make their way into the dining room. If a band is present, they may play "*The Roast Beef of Olde England*". No one may take their seats before the PMC.

Grace

When all diners are seated the PMC raps the table for silence with a gavel. The PMC requests a member of the mess to say grace. If a Chaplain is present, they would give the grace.

Passing the Port

In an air mess, the decanters should be moved to the left, never being placed on the table. The only time the decanter should be placed on the table is when the decanter is emptied, needing to be refilled or replaced, or when it arrives back to the PMC / VPMC.

Loyal Toast

The PMC calls upon the VPMC to toast the Queen of Canada. For example, they may say, "Mr. Vice, The Queen of Canada", or "Monsieur le vice-president, La Reine du Canada". The Vice-President announces, in the other official language, "Ladies and gentlemen, The Queen of Canada" or, "Mesdames et messieurs, La Reine du Canada". Diners announce individually "The Queen / La Reine" and take the Loyal Toast. The loyal toast is given while standing.

Marches

Following the toasts, "*Royal Canadian Air Force*" is played. If any other elements are present, the band will play the appropriate march. A member only stands at attention for their own march.

Speeches

After the toasts and marches have been completed, the PMC may open the floor to speeches by special guests.

Departing the Dining Room

Upon completion of all mess functions, the PMC shall conclude the mess dinner with a rap of the gavel. All members will stand for the departure of the head table.

Dinner Etiquette

Keep elbows close to the sides at all times and never place them on the table.

Silverware or glasses must not be placed with.

Silverware is laid out in the order in which it is to be used; the knives to the right of the plate and the forks to the left.

Bread must be broken with the fingers.

Never speak with food in the mouth or make gestures while utensils are in hands.

Never ask for anything that is not offered on the table such as butter, vinegar, or ketchup.

Tea or coffee should be sipped and the cup is replaced to the saucer between sips.

President of the Mess Committee (PMC)

The PMC is in absolute charge, regardless of rank or seniority. The PMC greets the guest of honour; escorts the guest of honour into the dining room, asks for grace to be said, levies fines against misbehaving members, begins passing the port, gives the loyal toast, dismisses for breaks, introduces the guest of honour; and escorts the guest of honour out of the dining room.

Vice-President of the Mess Committee (VPMC)

The VPMC assists the PMC in maintaining order during the Mess Dinner. They direct members to the dining room, pass on messages to the PMC from members, call the PMC's attention to any misbehaviour from other tables, begin passing the port, and assist in the Loyal Toast.

ROLE OF THE PRESIDENT OF THE MESS COMMITTEE (PMC)

Greeting the Guest of Honour

The PMC shall meet the guest of honour in the foyer of the mess, escort them into the before-dinner gathering and introduce them to the attendees and guests.

Escorting the Official Host or Guest of Honour

A bugler / piper, when available, shall make the appropriate calls to announce dinner. Following the second call, the PMC shall escort the guest of honour to the head table. In the absence of a bugler / piper, the mess call may be verbal.

Grace

Once the chief steward has advised the Vice-President of the Mess Committee (VPMC) that everyone is present, the PMC shall rap the gavel and ask the chaplain, or a previously designated member (often the most junior member present), to say grace.

Passing the Port

The PMC will indicate that the port may be passed by pouring a small amount of port into a glass, tasting it, and passing the decanter to the left.

Saying the Loyal Toast

The PMC calls upon the VPMC to toast the Queen of Canada. For example, they may say, "Mr. Vice, The Queen of Canada", or "Monsieur le vice-president, La Reine du Canada". The Vice-President announces, in the other official language, "Ladies and gentlemen, The Queen of Canada" or, "Mesdames et messieurs, La Reine du Canada". Diners announce individually "The Queen / La Reine" and take the Loyal Toast.

Dismissing for Breaks

The PMC may decide that a short break is needed if lengthy after-dinner speeches and presentations are scheduled. The break may be given before or after the passing of the port. The PMC shall announce that the head table members will leave the dining room first for the break and give a duration for the break. At the end of the break, the PMC shall rap the gavel for attention.

Introducing the Guest of Honour

The PMC shall introduce the guest of honour and other head table guests at an appropriate time during the dinner. All speeches are given after the toasts after which the PMC will make any announcements appropriate to the occasion.

Misbehaviour and Fines

When misbehaviour or transgressions of the rules of order in the mess occur, the PMC may:

1. warn the diner;
2. order an apology;
3. order a performance;
4. order a fine;
5. order the person to leave the mess; or
6. order any other fine deemed acceptable.

A member coming late to dinner may have their excuse accepted, but be refused permission to dine. The member may also be fined.

The following guidelines apply to fines:

- Fines imposed on a guest must be paid by their host.
- Fines are paid after the toasts.
- A diner may call the PMC's attention to a misdemeanour, but would be wise to ask permission to repeat, or demonstrate the infractions of the rules as to avoid a fine.

When dinner is finished and the tables cleared the senior steward reports to the President, "Table cleared, Sir / Ma'am".

Departing the Dining Room

When all speeches have concluded, the PMC indicates the end of the dinner and leads the head table out of the dining room.

ROLE OF THE VICE-PRESIDENT OF THE MESS COMMITTEE (VPMC)

As VPMC of the mess dinner you will assist the President of the Mess Committee (PMC) in maintaining order and, depending upon your corps / squadron, will:

Maintain Order

The VPMC can assist the PMC by controlling the behaviour of the table leg for which they are responsible and calling attention to inappropriate behaviour from other legs. The VPMC can also suggest appropriate fines for inappropriate behaviour.

Directing the Attendees to the Dining Room

The VPMC shall ensure that all personnel move quickly into the dining room and take position as soon as all personnel have entered the dining room. The chief steward shall discretely advise the VPMC that everyone is present.

Pass on Messages to the President from Members

If a diner wishes to address the PMC, they should make their wish known to a VPMC who then raps the gavel for silence, stands, faces the PMC and asks permission for the member to address the PMC.

Call to the PMC's Attention any Misbehaviour from other Tables

It is the duty of the VPMC to assist the PMC in maintaining order and discipline. As such, the VPMC needs to be aware of the conduct of all members of the mess, not just the members of which they are responsible. If the VPMC notices any behaviour that they feel is against the order and etiquette expected, they should bring it to the attention of the PMC.

Begin Passing the Port

If there are multiple decanters of port, the VPMC may control the passing of the port to the members of which they are responsible. The VPMC passes the port to the left and stoppers the decanter once it has made its way around the table. The VPMC pour their port last.

Give the Loyal Toast

The PMC calls upon the VPMC to toast the Queen of Canada. For example, they may say, "Mr. Vice, The Queen of Canada", or "Monsieur le vice-president, La Reine du Canada". The Vice-President announces, in the other official language, "Ladies and gentlemen, The Queen of Canada" or, "Mesdames et messieurs, La Reine du Canada".

THIS PAGE INTENTIONALLY LEFT BLANK

ORGANIZE A MESS DINNER AIDE-MEMOIRE

DRESS. The mess dinner is traditionally a formal dinner. As such, members attending the mess dinner are dressed in formal attire. Members of the military would wear the Number 2 order of dress, called mess dress, and this is true for cadets as well. Check the applicable dress CATO for further clarification.

OFFICIAL HOST. The Official Host of the Mess Dinner shall normally be the Commanding Officer of the cadet corps / squadron or representative.

GUEST OF HONOUR. The Guest of Honour, if there is one, shall be escorted to the mess by the President of the Mess Committee (PMC). In the absence of a Guest of Honour, the Official Host may be used.

PMC GREETING. The PMC shall meet the Official Host and the senior guest in the foyer of the mess and shall escort them to the before-dinner gathering where they shall present them to the mess membership.

MESS CALL. A signal (bugler, piper, recorded music, verbal cue) shall call the assembly to dinner. The first call occurs 15 minutes prior to the start of dinner. The second call occurs 5 minutes prior to the start of dinner. Following the second call, the PMC shall escort the Official Host / Guest of Honour to the head table. The Vice-President of the Mess Committee (VPMC) shall ensure that all personnel move quickly into the dining room and shall take their position as soon as all personnel have entered the dining room. Once assembled personnel have taken their position behind their respective seats, the VPMC informs the PMC that everyone is present. At that point the PMC shall rap his/her gavel and ask the previously designated member (quite often the most junior member present), to say grace. At the completion of grace, all shall be seated.

INTRODUCTION BY PMC. At the beginning of the dinner after everyone is seated the PMC shall introduce the head table.

DINNER ETIQUETTE. The mess dinner is a time to appreciate the fellowship and conversation of fellow personnel and guests, to enjoy good food and to enjoy relaxed formality in an elegant setting. Diners should not display immature or offensive behaviour.

FINES. If members behave in an immature or offensive manner they may be fined. If not taken to an extreme this can be an entertaining part of a mess dinner. Fines are imposed for members who break, bend, or knowingly conceal a breach of mess rules by another member.

Fines levied against an individual may vary:

- dismissal from the mess;
- apology;
- performance;
- warning; or
- any other fine deemed acceptable by the President.

BREAK. On occasions where lengthy after-dinner formalities such as speeches and presentations are scheduled, the PMC may decide that a short break is needed which, at their discretion, may occur before or after the passing of the Port depending on the number and length of speeches and the number of diners in attendance. At the end of the break, the PMC shall rap the gavel for attention.

PASSING THE PORT. After the last course has been served and the tables have been cleared or after the break, decanters shall be placed on the tables. The Mess Manager or person acting as Chief Steward shall indicate to the PMC that the Port is ready to be passed. At that point the stoppers shall be removed, and the PMC will indicate that the Port may be passed by pouring a small amount of Port into their glass, tasting it, and

passing the decanter to the left. The passing of the port shall be done in accordance with elemental tradition. Once Port has been poured into the glass, it shall not be touched until it is time for the Loyal Toast.

ALCOHOLIC BEVERAGES. As per regulation, alcoholic beverages shall not be served at the mess dinner. Grape juice shall be used to uphold the tradition of passing the Port. All references to Port in this document refer to Grape Juice.

LOYAL TOAST. When the Mess Manager, or person acting as Chief Steward, has indicated to the PMC that all have been served Port, the PMC shall rap the gavel for attention, all conversation shall cease, the PMC shall rise, and shall announce to the Vice-PMC, either, "Mr. Vice, The Queen of Canada", or "Monsieur le vice président, La Reine du Canada". The Vice-PMC will then rise and announce in the other official language, "(ladies and) gentlemen, The Queen of Canada" or, "(Mesdames et) messieurs, La Reine du Canada", as appropriate. At that point all personnel and guests shall rise and shall pick up their glass of Port and hold it at waist level announcing individually, in French or English, "The Queen"/"La Reine", and take the Loyal Toast. Glasses shall be lowered to the table, and the assembly shall be seated. It is important to note that it is naval tradition to remain seated for the loyal toast.

The PMC will then make any announcements appropriate to the occasion, and introduce the Official Host if the latter wishes to speak. The Official host will introduce the Guest of Honour. The PMC, Official Host and Guest of Honour are not to be interrupted during their remarks.

DEPARTING THE DINING ROOM. When all speeches have been concluded and the Official Host has indicated to the PMC that it is time to depart the dining room, all in attendance shall rise and remain standing until the Official Host, Senior Guest, PMC, and head table guests have moved from the dining room.

SEATING ARRANGEMENT. The tables of the mess dinner can be arranged in many ways. They may be arranged as a long table or a head table with several legs. The seating of the PMC and VPMC may also vary. Below are some examples of seating arrangements.

When placing members at tables, it is important to have a mix of ranks at each table. Whenever possible, genders should be mixed. Tables should be filled from the head table towards the end of the leg and there should never be empty place settings. If a member is unable to attend, their place setting should be removed and the remaining members should spread to fill in the empty space.

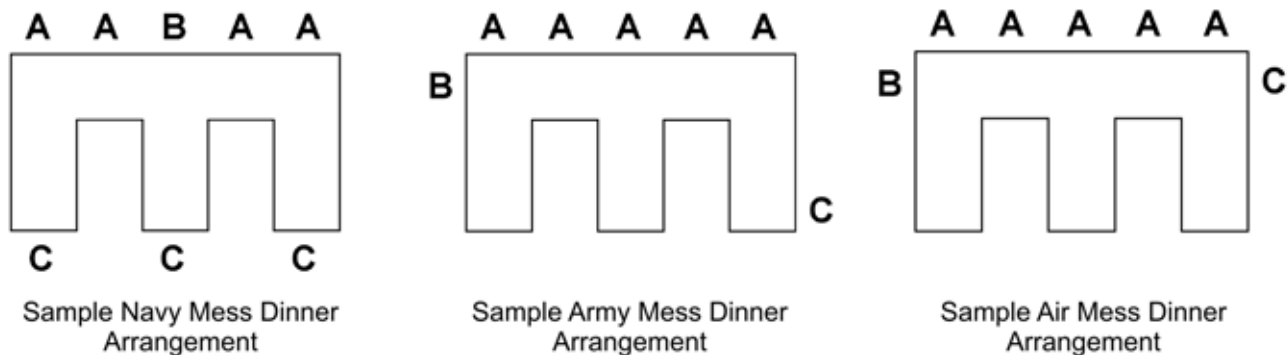

Figure F-1 Sample Elemental Dinner Arrangements

Symbol	Meaning
A	Invited Guests
B	President of the Mess Committee
C	Vice President of the Mess Committee

PLACE SETTINGS. Traditionally, mess dinners are a formal occasion with formal place settings. A variety of utensils may be used. Diners should use utensils starting with the utensils on the outside. Utensils are changed with each course of the meal.

A variety of glasses may also be used. Each glass has a specific purpose. As there will be no alcohol served during the dinner, it is acceptable to only use one glass.

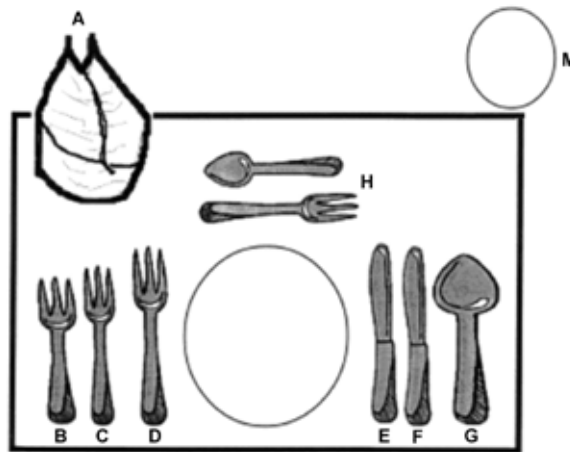

Figure F-2 Table Setting

Napkin and Dinner Roll (Item A)

The napkin and dinner roll will be placed on the table at the place setting prior to diners taking their seats.

Salad Fork (Item B)

The first course is either a mixed green or fruit salad. Eat the salad with the salad fork found on the extreme left of the dinner plate. No knife is to be used with the salad. If the salad cannot be picked up with the fork it must be left on the plate. Do not push food onto the fork with fingers.

While eating the appetizer, the fork should be laid at a 45-degree angle from the centre of the plate to indicate to the steward the meal is not completed. When the course is completed, the fork is placed at a six o'clock on the plate to indicate to the steward the meal is complete.

Soup Spoon (Item G)

Eat the soup with the soup spoon found on the extreme right of the dinner plate. Soup is always taken from the side of the spoon. The motion of the spoon should be from the front to the back of the bowl. Never tip the bowl to get the last drop or blow on the soup to cool it.

While eating the soup, the spoon should be laid at a 45-degree angle from the centre of the bowl to indicate to the steward the meal is not completed. When the course is completed the spoon is placed at a six o'clock in the bowl to indicate to the steward the meal is complete.

Fish Fork and Knife (Items C and F)

Use the fish knife found on the extreme right and the middle fork to eat the fish course. Place the knife in the right hand and the fork in the left. A left-handed person may reverse the cutlery. While eating the fish, the fork and knife should be laid at a 45-degree angle from one another from the centre of the plate to indicate to the steward the meal is not completed. When the course is completed the fork and knife are placed together at a 45-degree angle from the centre of the plate to indicate to the steward the meal is complete.

Dinner Fork and Knife (Items D and E)

Use the last set of cutlery on either side of the plate to eat the main course. The cutlery is held in the same way as the fish course. Never pick up the meat with the hands. Only eat what can be cut with the knife and fork.

While eating the main course, the fork and knife should be laid at a 45-degree angle to one another from the centre of the plate to indicate to the steward the meal is not completed. When the course is completed the fork and knife are placed together at a 45-degree to indicate to the steward the meal is complete.

Dessert Service (Item H)

The last course is dessert. There are two pieces of cutlery laid out for dessert found at the top of the place setting. It is only necessary to use one. The dessert is the end of the meal, but not the end of the dinner. While eating the desert, the spoon or fork should be laid at a 45-degree angle to indicate to the steward the meal is not completed. When the course is completed the spoon or fork is placed at six o'clock on the plate to indicate to the steward the meal is complete.

Water Glass (Item M)

Water will be served to all members prior to the start of the dinner.



**COMMON TRAINING
ALL TRAINING LEVELS
INSTRUCTIONAL GUIDE
CANADIAN ARMED FORCES
(CAF) FAMILIARIZATION**



SECTION 5

EO MX20.01E – ATTEND A CAF PRESENTATION

Total Time:

One session (3 periods) = 90 min

**THERE IS NO INSTRUCTIONAL GUIDE PROVIDED FOR THIS EO. REFER TO
THE LESSON SPECIFICATION LOCATED IN A-CR-CCP-701/PG-001, ROYAL
CANADIAN ARMY CADETS GREN STAR QUALIFICATION STANDARD AND PLAN.**

THIS PAGE INTENTIONALLY LEFT BLANK



**COMMON TRAINING
ALL TRAINING LEVELS
INSTRUCTIONAL GUIDE
CANADIAN ARMED FORCES
(CAF) FAMILIARIZATION**



SECTION 6

EO MX20.01F – ATTEND A CAF COMMEMORATIVE CEREMONY

Total Time:

One session (3 periods) = 90 min

**THERE IS NO INSTRUCTIONAL GUIDE PROVIDED FOR THIS EO. REFER TO
THE LESSON SPECIFICATION LOCATED IN A-CR-CCP-701/PG-001, ROYAL
CANADIAN ARMY CADETS GREEN STAR QUALIFICATION STANDARD AND PLAN.**

THIS PAGE INTENTIONALLY LEFT BLANK



**COMMON TRAINING
ALL TRAINING LEVELS
INSTRUCTIONAL GUIDE
CANADIAN ARMED FORCES
(CAF) FAMILIARIZATION**



SECTION 7

EO MX20.01G – PARTICIPATE IN CAF FAMILIARIZATION VIDEO ACTIVITIES

Total Time:

One session (3periods) = 90 min

PREPARATION

PRE-LESSON INSTRUCTIONS

This IG supports EO MX20.01G (Participate in CAF Familiarization Video Activities) located in A-CR-CCP-701/PG-001, *Royal Canadian Army Cadets Green Star Qualification Standard and Plan*, Chapter 4.

Instructors may choose their own CAF Familiarization video and create their own fun and interactive activities, or choose a video from the following list:

- *A War Of Their Own – The Canadians in Sicily and Italy – Part 1* (60 minutes),
- *A War Of Their Own – The Canadians in Sicily and Italy – Part 2* (60 minutes),
- *Operation Apollo – The Canadian Navy in the War Against Terrorism, 2001-2003* (30 minutes),
- *The Boys of Kelvin High – Canadians in Bomber Command – Part 1* (60 minutes),
- *The Boys of Kelvin High – Canadians in Bomber Command – Part 2* (60 minutes),
- *The Van Doos in Afghanistan* (45 minutes), and
- *The International Fleet Reviews of The Canadian Navy Centennial 2010* (22 minutes).

Photocopy the applicable video question page, located at Annex A, for each cadet or prepare your own. Answer pages are located at Annex B.

Gather the required resources:

- video equipment (eg, television, DVD player, tablet, laptop, speakers),
- video, and
- any other resources required as per the selected activity.

PRE-LESSON ASSIGNMENT

Nil.

APPROACH

An in-class activity was chosen for this lesson as it is a fun and interactive way to build on the cadets' knowledge of the CAF.

INTRODUCTION

REVIEW

Nil.

OBJECTIVES

By the end of this session the cadets shall have watched a CAF Familiarization video.

IMPORTANCE

It is important for cadets to watch a CAF video as a part of stimulating an interest in the sea, land and air activities of the CAF.

ACTIVITY

1. Conduct an introductory activity to ascertain the cadets' knowledge of the topic of the video they will be watching. Check the suggested activities instructor box below for activities. Introductory activities should cover the following:
 - (a) the significance of the video(s) being watched, or
 - (b) the role of the CAF in the video.
2. Distribute the applicable video question page located at Annex A and provide any additional details to the cadets.
3. Have the cadets watch the video.
4. Conduct a debriefing and have the cadets reflect on what they saw and how it affected their perceptions of the CAF. Check the suggested follow-up activities box below for activities.



SUGGESTED INTRODUCTORY ACTIVITIES

Brainstorm. As a large group or in smaller groups, have the cadets list what they know about the video topic (eg, WW II Bombers). If the video topic is not well-known, prepare questions that may help stimulate the cadets' thinking (eg, What was the role of Bomber Command? Where were the bombers located? How many crew were in a bomber?). If conducted as a large group, write down key words in a thought web as the cadets brainstorm.

Think – Pair – Share. Have the cadets individually think about and list what they know about the video topic (eg, Operation Apollo). Have the cadets share what they know about the video topic with a partner. Invite the cadets to share what they learned from their partner with the larger group.

KWL Chart. Have the cadets complete a chart with three columns:

- what they **K**now about the video topic (eg, the International Fleet Review),
- what they **W**ant to know about the video topic, and
- what they have **L**earned about the video topic (to be completed after watching the video as part of the follow-up activity).



SUGGESTED FOLLOW-UP ACTIVITIES

Highlights. Have the cadets individually list the three most interesting or surprising things they learned from watching the video. Have the cadets share and discuss these highlights with a partner or in small groups. If time permits, invite cadets to share highlights with the larger group.

Cadets' Questions. Have the cadets write a question they have after watching the video. In other words, what more would they like to learn about this topic? Answer the cadets' questions or challenge them to find out the answer to their own question prior to the next session.

Activity Leader's Questions. Have the cadets respond to thought-provoking questions about the video topic. For example, if the video topic is Operation Apollo, questions could include: How did the Canadian Government's resolution to not become involved in the offensive operations in Iraq affect the Canadian ships in the Persian Gulf. Do you agree with the Government's decision? Why?

CONCLUSION

METHOD OF EVALUATION

Nil.

CLOSING STATEMENT

It is important for cadets to have an understanding of the sea, land and air activities of the CAF.

INSTRUCTOR NOTES / REMARKS

There are potential leadership opportunities for cadets when conducting CAF Familiarization video activities:

- Phase Five / Master Cadet / Proficiency Level Five cadets may plan, prepare and conduct the session as a leadership project IAW PO 503 (Lead Cadet Activities); and
- Phase Three / Silver Star / Proficiency Level Three, Phase Four / Gold Star / Proficiency Level Four, and Phase Five / Master Cadet / Proficiency Levels Five cadets may complete leadership assignments IAW POs 303 (Perform the Role of a Team Leader), 403 (Act as a Team Leader), and 503 (Lead Cadet Activities), such as leading a CAF Familiarization video activity.

REFERENCES

DVD Video Chadderton, H. C. (Producer) (2000). *A war of their own: The Canadians in Sicily and Italy*. Ontario: The War Amps of Canada.

DVD Video Gimblett, R. H. (Author) (2004). *Operation Apollo: The Canadian navy in the war against terrorism – 2001-2003*. Canada: Magic Light Publishing.

DVD Video H. Chadderton, H. C. (Producer) (2005). *The boys of Kelvin High: Canadians in bomber command*. Ontario: The War Amps of Canada.

DVD Video Guilmain, C. (Director) (2012). *The van doos in Afghanistan*. National Film Board of Canada.

DVD Video (2010). *The international fleet reviews of The Canadian navy centennial 2010*. Canada: Department of National Defence.

THIS PAGE INTENTIONALLY LEFT BLANK

The Boys of Kelvin High
The End of the Beginning
Questions - Part 1

Run Time: 57 min 30 sec

Outline: A remarkable story of those who flew in mighty bombers night after night. Against great adversity, they pressed on in a relentless drive to defeat Hitler's Nazi regime. *The End of the Beginning* follows the airmen through training, crewing up, the Battle of the Ruhr and the Dambusters Raid.

Answer the following questions while watching the movie. Questions are drawn directly from the movie and include the time stamps where the answer can be found.

1. 8:00 – A Lancaster Crew that “goes for the chop?” has been

_____.

2. 14:00 – From the list below, circle five of the jobs that recruits may have been chosen for at Number 1 Air Training School in 1940:

Pilot	Navigator	Mechanic	Stewart
Bomb Aimer	Wireless Operator	Gunner	

3. 20:25 – Canadian's accounted for _____% of British Bomber Crews.

4. 29:10 – The head mechanic was often called _____.

5. 33:35 – What is the traditional meal that flight crews eat before departing on a mission?

_____ and _____.

6. 40:00 – Pathfinders bomber crews were:

7. 49:45 – The Squadron in Bomber Command who raided German hydro-electric dams in May 1943 were called the _____.

***The Boys of Kelvin High
Press on Regardless
Questions - Part 2***

Run Time: 57 min 30 sec

Outline: A remarkable story of those who flew in mighty bombers night after night. Against great adversity, they pressed on in a relentless drive to defeat Hitler's Nazi regime. *Press on Regardless* continues to explore the experiences and dangers faced by the air crews in raids such as Peenemunde and the Battle of Berlin.

Answer the following questions while watching the movie. Questions are drawn directly from the movie and include the time stamps where the answer can be found.

1. 08:50 – An accurate radar pulse system named "Oboe" was used primarily in the _____ aircraft.
2. 10:00 – Metal or aluminum foil strips dropped from an aircraft are called _____.
3. 12:20 – Bomber crews were greatly concerned by German "flack" guns which could often hit targets as high as _____ feet in the air.
4. 17:00 – In March 1943, British Intelligence became aware of a secret German long range pilotless _____ called V1 and V2.
5. 27:55 – More than 50% of those who flew with _____ were killed, wounded or taken prisoner.
6. 28:05 – The average life expectancy of an aircraft crew was about _____ sorties.

***A War of Their Own
Questions - Part 1***

Run Time: 60 min

Outline: The story showing how the Canadians in Sicily and Italy faced tremendous odds never before experienced by the Canadian Army and developed innovative techniques to fight in an inhospitable terrain against an experienced enemy force during almost two years of steady fighting.

Answer the following questions while watching the movie. Questions are drawn directly from the movie and include the time stamps where the answer can be found.

1. 06:00 – Why was awarding Corporal Huron Brant a medal significant?

First battle in Sicily	Aboriginal Status
German Background	Entrance into Rome

2. 16:00 – CAF Engineers' creativity was commended by international militaries for learning how to _____ landmines.

3. 21:00 – Where did multiple trades and branches (army, navy, air force) of the CAF work together for a decisive victory?

Victoria	Maples
Bell Island	Messina

4. 24:00 – What famous battle tactic did Canadian Colonel Cy Neroutsos receive credit for, which replaced the British system of the 'Creeping Barrage'?

5. 50:00 – Name the strategy created by Canadians, during the battle of Ortona, which protected CAF members from being exposed to danger on the streets?

***A War of Their Own
Questions - Part 2***

Run Time: 60 min

Outline: A story paying tribute to the 1st and 5th Canadian Divisions and the 1st Canadian Armoured Brigade which formed the spearhead into the heart of Europe and held down 20 German divisions that otherwise would have been able to defend Northern Italy. The Canadians in Italy, in a questionable jest, were called the D-Day Dodgers.

Answer the following questions while watching the movie. Questions are drawn directly from the movie and include the time stamps where the answer can be found.

1. 04:00 – What was the name of the secret commando unit breaking across the mountainous Hitler Line toward Rome?

First Special Service Force	Airborne
Joint Task Force 2	Canadian Special Operations Regiment

2. 13:00 – Circle the regiments which were involved in breaking the Gustav Line?

Toronto 48 th Highlanders	3 Rivers Regiment
Royal Canadian Regiment	Royal 22 nd Van Doos

3. 20:00 – The Canadian _____ Sisters played an important role for women wishing to contribute to supporting the combat troops.

4. 30:00 – Troops fighting in the Italian campaign became known as D-Day dodgers. In which country did they not fight?

5. 44:00 – Which CAF trooper, from the Seaforth Highlanders, earned the Victoria Cross during the battle of Savio for destroying 2 tanks and repelling the accompanying infantry?

The Van Doos in Afghanistan
Questions

Run Time: 45 min

Outline: In this documentary, we hear directly from soldiers serving in the Royal 22^e Régiment. Members of the regiment were filmed in the field in March 2011, during their deployment to Afghanistan. They speak with ease and a rare candour about themselves and their work, whether out on patrol or performing their duties at the base. The films images and interviews bring home the complexity of the issues on the ground and shed light on the little understood experiences of the men and women who served in Afghanistan.

Answer the following questions while watching the movie. Questions are drawn directly from the movie and include the time stamps where the answer can be found.

1. 01:00 – In which Afghan district did the Van Doos conduct their operations?

Kandahar	Kabul	Panjwai	Helmand
----------	-------	---------	---------

2. 12:00 – The CAF often carried out tasks to provide _____ project security.

3. 20:00 – What trade was the injured CAF member who delegated commands to carry out the required task?

Infantry	Medic
Logistics	Sailor

4. 28:00 – What is the motto that the Van Doos use to describe their approach in Afganistan?

5. 34:00 – What was Private Stephane Perreault’s civilian occupation before enlisting in the CAF?

***The International Fleet Reviews of the
Canadian Navy Centennial
Questions***

Run Time: 22 min

Outline: In this documentary, the Royal Canadian Navy looked at their first century as a national institution, commemorating and celebrating 100 years of naval service, while committing themselves anew to the second century upon which they have just embarked.

Answer the following questions while watching the movie. Questions are drawn directly from the movie and include the time stamps where the answer can be found.

1. 3:45 – The 18 ships of the Pacific Fleet were reviewed by Her Excellency the _____ of Canada, Michaëlle Jean.
2. 5:40 – HMCS _____ carried the Governor General during the Pacific Fleet Review.
3. 8:50 – The review culminated with an Air Force display by 413 Squadron, who are commonly known as The _____.
4. 10:40 – Her Majesty Queen Elizabeth II, of _____, arrived during the afternoon of June the 29th.
5. 12:40 – During the Atlantic Fleet Review, the saluting guns were fired by crews from HMCS Halifax and local _____.
6. 14:40 – Nearly _____ Canadian and allied ships attended the Fleet Review in Halifax.
7. 20:50 – The Royal Canadian Navy presented a sovereign sword to Her Majesty The Queen. The sword will remain in _____ to be carried by the officer in charge of the colour guard when ever The Queen's colour is paraded.

**Operation Apollo
Questions**

Run Time: 30 min

Outline: Operation Apollo explains Canada's naval contribution to the international campaign against terrorism in the aftermath of the September 11, 2001 terrorist attacks in the United States. This documentary shows how the Canadian Navy mobilized, with one ship at first, growing to six ships and 1 500 navy personal at the height of the operation. While deployed, ships participated in force-protection operations, fleet-support operations, leadership interdiction operations, and maritime interdiction operations. Canadian Naval Boarding personnel hailed more than 10 000 ships and conducted more than 260 boardings - almost 60 percent of the entire coalition fleet's boardings.

Answer the following questions while watching the movie. Questions are drawn directly from the movie and include the time stamps where the answer can be found.

1. 1:20 – Vice-Admiral _____, the head of the Canadian Navy, issued orders to assemble a Canadian Task Group soon after the September 11, 2001 attacks.
2. 5:05 – Small wooden hull ships, called _____, are difficult to detect with radar and are thought be packed with explosives.
3. 10:35 – HMCS Algonquin captured two al-Qaeda terrorists who were traveling in the following type of boat:

hutch go fasts destroyer
4. 17:42 – HMCS _____ had to return back to Halifax because its _____ was damaged.
5. 21:10 – There is no doubt in Commodore Girard's mind that the Strait of Hormuz was _____ for the Canadian Fleet being there.

THIS PAGE INTENTIONALLY LEFT BLANK

The Boys of Kelvin High
The End of the Beginning
Answers - Part 1

Run Time: 57min 30 sec

Outline: A remarkable story of those who flew in mighty bombers night after night. Against great adversity, they pressed on in a relentless drive to defeat Hitler's Nazi regime. *The End of the Beginning* follows the airmen through training, crewing up, the Battle of the Ruhr and the Dambusters Raid.

Answer the following questions while watching the movie. Questions are drawn directly from the movie and include the time stamps where the answer can be found.

1. 8:00 – A Lancaster Crew that "goes for the chop?" has been

 SHOT

 DOWN .

2. 14:00 – From the list below, select a few of the jobs that recruits may have been chosen for at Number 1 Air Training School in 1940:

Pilot

Navigator

Mechanic

Stewart

Bomb Aimer

Wireless Operator

Gunner

3. 20:25 – Canadian's Accounted for **25** % of British Bomber Crews.

4. 29:10 – The head mechanic was often called: **CHIEFIE** .

5. 33:35 – What is the traditional meal that flight crews eat before departing on a mission? **BACON** and **EGGS** .

6. 40:00 – Pathfinders bomber crews were:

Promoted by one rank

Highly skilled in navigation

On their second tour

Wore a gold wing on the left pocket

7. 49:45 – The Squadron in Bomber Command who raided German hydro-electric dams in May 1943 were called the **DAMBUSTERS** .

***The Boys of Kelvin High
Press on Regardless
Answers - Part 2***

Run Time: 57min 30 sec

Outline: A remarkable story of those who flew in mighty bombers night after night. Against great adversity, they pressed on in a relentless drive to defeat Hitler's Nazi regime. *Press on Regardless* continues to explore the experiences and dangers faced by the air crews in raids such as Peenemunde and the Battle of Berlin.

Answer the following questions while watching the movie. Questions are drawn directly from the movie and include the time stamps where the answer can be found.

1. 08:50 – An accurate radar pulse system named “Oboe” was used primarily in the
 MOSQUITO aircraft.
2. 10:00 – Metal or aluminum foil strips dropped from an aircraft are called
 WINDOW .
3. 12:20 – Bomber crews were greatly concerned by German “flack” guns which
could often reach as high as **10 000 – 11 000** feet in the air.
4. 17:00 – In March 1943, British Intelligence became aware of a secret German long
range pilotless **BOMB OR ROCKET** called V1 and V2.
5. 27:55 – More than 50 % of those who flew with **BOMBER COMMAND** were killed,
wounded or taken prisoner.
6. 28:05 – The average life expectancy of an aircraft crew was about **14** sorties.

A War of Their Own
Answers - Part 1

Run Time: 60 min

Outline: The story showing how the Canadians in Sicily and Italy faced tremendous odds never before experienced by the Canadian Army and developed innovative techniques to fight in an inhospitable terrain against an experienced enemy force during almost two years of steady fighting.

Answer the following questions while watching the movie. Questions are drawn directly from the movie and include the time stamps where the answer can be found.

1. 06:00 – Why was the awarding of Cpl Huron Brant a medal significant?

First battle in Sicily

Aboriginal Status

German Background

Entrance into Rome

2. 16:00 – CAF Engineers' creativity was commended by international militaries for learning how to DEFUSE landmines.

3. 21:00 – Where did multiple trades and branches (army, navy, air force) of the CAF work together for a decisive victory?

Victoria

Maples

Bell Island

Messina

4. 24:00 – What famous battle tactic did Canadian Colonel Cy Neroutsos receive credit for, which replaced the British system of the 'Creeping Barrage'?

JOCK COLUMN

5. 50:00 – Name the strategy created by Canadians, during the battle of Ortona, which protected CAF members from being exposed to danger on the streets?

MOUSE HOLING

***A War of Their Own
Answers - Part 2***

Run Time: 60 min

Outline: A story paying tribute to the 1st and 5th Canadian Divisions and the 1st Canadian Armoured Brigade which formed the spearhead into the heart of Europe and held down 20 German divisions that otherwise would have been able to defend Northern Italy. The Canadians in Italy, in a questionable jest, were called the D-Day Dodgers.

Answer the following questions while watching the movie. Questions are drawn directly from the movie. Each question includes the time stamp where the answer can be found.

1. 04:00 – What was the name of the secret commando unit breaking across the mountainous Hitler Line toward Rome?

First Special Service Force Airborne

Joint Task Force 2 Canadian Special Operations Regiment

2. 13:00 – Circle the regiments which were involved in breaking the Gustav Line?

Toronto 48th Highlanders **3 Rivers Regiment**

Royal Canadian Regiment **Royal 22nd/ Van Doos**

3. 20:00 – The Canadian **NURSING** Sisters played an important role for women wishing to contribute to supporting the combat troops.

4. 30:00 – Troops fighting in the Italian campaign became known as D-Day dodgers. In which country did they not fight?

FRANCE

5. 44:00 – Which CAF trooper, from the Seaforth Highlanders, earned the Victoria Cross during the battle of Savio for destroying 2 tanks and repelling the accompanying infantry?

PRIVATE EARNEST “SMOKEY” SMITH

The Van Doos in Afghanistan
Answers

Run Time: 45 min

Outline: In this documentary, we hear directly from soldiers serving in the Royal 22e Régiment. Members of the regiment were filmed in the field in March 2011, during their deployment to Afghanistan. They speak with ease and a rare candour about themselves and their work, whether out on patrol or performing their duties at the base. The films images and interviews bring home the complexity of the issues on the ground and shed light on the little understood experiences of the men and women who served in Afghanistan.

Answer the following questions while watching the movie. Questions are drawn directly from the movie and include the time stamps where the answer can be found.

- 01:00 – In which Afghan district did the Van Doos conduct their operations?
Kandahar Kabul **Panjwai** Helmand
- 12:00 – The CAF often carried out tasks to provide CONSTRUCTION project security.
- 20:00 – What trade was the injured CAF member who delegated commands to carry out the required task?
Infantry **Medic**
Logistics Sailor
- 28:00 – What is the motto that the Van Doos use to describe their approach in Afganistan?
FIGHT CONVINCE BUILD
- 34:00 – What was Private Stephane Perreault’s civilian occupation before enlisting in the CAF?

COMPUTER MACHINIST

***The International Fleet Reviews of the
Canadian Navy Centennial
Answers***

Run Time: 22 min

Outline: In this documentary, the Royal Canadian Navy looked at their first century as a national institution, commemorating and celebrating 100 years of naval service, while committing themselves anew to the second century upon which they have just embarked.

Answer the following questions while watching the movie. Questions are drawn directly from the movie and include the time stamps where the answer can be found.

1. 3:45 – The 18 ships of the Pacific Fleet were reviewed by Her Excellency the GOVERNOR GENERAL of Canada, Michaëlle Jean.
2. 5:40 – HMCS ALGONQUIN carried the Governor General during the Pacific Fleet Review.
3. 8:50 – The review culminated with an Air Force display put on by 413 Squadron, who are commonly known as The SNOWBIRDS.
4. 10:40 – Her Majesty Queen Elizabeth II, of CANADA arrived during the afternoon of June the 29th.
5. 12:40 – During the Atlantic Fleet Review, the saluting guns were fired by crews from HMCS Halifax and local SEA CADETS.
6. 14:40 – Nearly 30 Canadian and allied ships attended the Fleet Review in Halifax.
7. 20:50 – The Royal Canadian Navy presented a sovereign sword to Her Majesty The Queen. The sword will remain in CANADA to be carried by the officer in charge of the colour guard when ever The Queen's colour is paraded.

Operation Apollo
Answers

Run Time: 30 min

Outline: Operation Apollo explains Canada's naval contribution to the international campaign against terrorism in the aftermath to the September 11, 2001 terrorist attacks in the U.S. This short documentary shows how the Canadian Navy mobilized, with one ship at first, growing to six ships and 1,500 navy personnel at the height of the operation. While deployed, ships participated in force-protection operations, fleet-support operations, leadership interdiction operations, and maritime interdiction operations. Canadian Naval Boarding personnel hailed more than 10,000 ships and conducted more than 260 boardings - almost 60 percent of the entire coalition fleet's boardings.

Answer the following questions while watching the movie. Questions are drawn directly from the movie and include the time stamps where the answer can be found.

1. 1:20 – Vice-Admiral RON BUCK, the head of the Canadian Navy, issued orders to assemble a Canadian Task Group soon after the September 11, 2001 attacks.
2. 5:05 – Small wooden hull ships, called DUOES, are difficult to detect with radar and are thought be packed with explosives.
3. 10:35 – HMCS Algonquin captured two al-Qaeda terrorists who were traveling in the following type of boat:

hutch **go fasts** destroyer
4. 17:42 – HMCS IROQUOIS had to return back to Halifax because its HELICOPTER was damaged.
5. 21:10 – There is no doubt in Commodore Girard's mind that the Strait of Hormuz was SAFER for the Canadian Fleet being there.

THIS PAGE INTENTIONALLY LEFT BLANK



COMMON TRAINING
ALL TRAINING LEVELS
INSTRUCTIONAL GUIDE
CANADIAN ARMED FORCES
(CAF) FAMILIARIZATION



SECTION 8

EO MX20.01H – PARTICIPATE IN CAF FAMILIARIZATION LEARNING STATIONS

Total Time:

One session (3periods) = 90 min

PREPARATION

PRE-LESSON INSTRUCTIONS

This IG supports EO MX20.01H (Participate in CAF Familiarization Learning Stations) located in A-CR-CCP-701/PG-001, *Royal Canadian Army Cadets Green Star Qualification Standard and Plan*, Chapter 4.

Select learning stations as per chart.

Topic	Learning Station	Self-Directed	Instructor Led	15 min	30 min	60 min
CAF History	Annex A	CAF History – Timeline		X		X
	Annex B	CAF History – Canada Remembers		X		X
	Annex C	CAF History – Reflection Activity		X	X	
	Annex D	Battle of the Atlantic – Battleship Game	X			X
	Annex E	Battle of Vimy Ridge – Battletank Game	X			X
	Annex F	Battle of Britain – Battleplane Game	X			X
	Annex G	Battle of the Atlantic		X		X
	Annex H	Battle of Vimy Ridge		X		X
	Annex I	Battle of Britain		X		X
	Annex J	British Commonwealth Air Training Plan		X		X

Topic		Learning Station	Self-Directed	Instructor Led	15 min	30 min	60 min
Roles of the CAF	Annex K	Roles of the CAF		X		X	
	Annex L	Roles of the CAF – Defending Canada		X		X	
	Annex M	Roles of the CAF – Defending North America	X	X	X		
	Annex N	Roles of the CAF – Contributing to International Peace and Security	X	X	X		
Current CAF	Annex O	CAF Six Core Missions		X			X
	Annex P	Current CAF		X			X
	Annex Q	DART and DTAL	X	X		X	
CAF Careers	Annex R	CAF Careers	X	X	X		
	Annex S	Life in the Royal Canadian Navy, Royal Canadian Air Force or Canadian Army		X	X		
Contact a Deployed CAF Member	Annex T	Contact a Deployed CAF Member	X	X		X	

Plan and prepare activities as per Annexes A–T.

In addition to the suggested activities at Annexes A–T, activity leaders may choose to create their own interactive, challenging and fun activities.

Gather the required resources for the selected activities, as well as a stopwatch. Some learning stations require assistant instructors.

PRE-LESSON ASSIGNMENT

Nil.

INTRODUCTION

APPROACH

Learning stations were chosen for this lesson as they are a fun and interactive way to build on the cadets' knowledge of the CAF.

REVIEW

Nil.

OBJECTIVES

By the end of this session the cadets shall have gained a better understanding of the CAF through topics covered in the selected learning stations.

IMPORTANCE

It is important for cadets to participate in CAF familiarization learning stations to develop an understanding of the CAF and its history, role, and contributions within Canada and the international community. These learning stations also tie directly to the aim of the Cadet Program to stimulate the interest of youth in the sea, land and air activities of the CAF.

ACTIVITY

1. Divide the cadets into groups.
2. Arrange a system of rotation for groups to move through the stations. Explain the procedure for moving from one station to the next, the time allotted for each station and the signal to switch.
3. Assign each group to their first learning station.
4. Supervise and provide guidance where necessary.

CONCLUSION

METHOD OF EVALUATION

Nil.

CLOSING STATEMENT

The learning stations develop an understanding of the CAF, its history, role, and contributions within Canada and the international community. By participating in these learning stations, you have become more aware of the sea, land and air activities of the CAF.

INSTRUCTOR NOTES / REMARKS

There are a number of resources available to make learning about the CAF interesting and interactive. Some of these include:

- Over The Top - an interactive adventure game that allows participants to experience life in the trenches during the First World War.
http://www.warmuseum.ca/cwm/games/overtop/index_e.shtml
- Armoured Warrior - an interactive game that is based on the experiences of the First Canadian Army in combat in the Second World War.
<http://www.civilization.ca/cwm/games/armwar/history.shtml>
- Canadian Military History Gateway - an online service providing access to websites and digitized resources about Canada's military history.
<http://www.cmhg.gc.ca/flash/index-eng.asp?t=1>
- Juno Beach Centre, Teacher Resources - a list of resources available from a variety of sources including activities, videos, audios, websites etc.
<http://www.junobeach.org/centre/english/education/plans.html>
- Canadian Armed Forces Imagery Gallery and the Canadian Forces Combat Camera - Combat camera is a direct link from the front line to the front page and the image gallery has photos from operations since 1990.
<http://www.combatcamera.forces.gc.ca/site/combat-camera-eng.asp>

There are numerous potential leadership opportunities for cadets when conducting these learning stations:

- Phase Five / Master Cadet / Proficiency Level Five cadets may plan, prepare and conduct the learning stations activity as a leadership project IAW PO 503 (Lead Cadet Activities); and
- Phase Three / Silver Star / Proficiency Level Three, Phase Four / Gold Star / Proficiency Level Four, and Phase Five / Master Cadet / Proficiency Levels Five cadets may complete leadership assignments IAW POs 303 (Perform the Role of a Team Leader), 403 (Act as a Team Leader), and 503 (Lead Cadet Activities), such as leading a CAF familiarization learning station.

REFERENCES

Canadaatwar.ca. (2013). *WW I: The Battle of Vimy Ridge – Canada At War*. Retrieved March 26, 2013 from <http://www.canadaatwar.ca/page9.html>

Canadian Forces. (2012). *Roles of the Canadian Forces*. Retrieved March 25, 2013 from <http://www.forces.gc.ca/site/pri/first-premier/defstra/role-eng.asp>

Canadian Geographic. (2011) *Canada's Worst Natural Disaster of all Time*. Retrieved March 25, 2013 from <http://www.canadiangeographic.ca/blog/posting.asp?ID=439>

Canadianbusiness.com. (2012). *Q&A with fighter pilot Kirk 'Rambo' Soroka*. Retrieved March 25, 2013 from <http://www.canadianbusiness.com/wp-content/uploads/2012/02/50b9b9914147a66f1c0f53a4066a.jpg>

Canadian Military History Gateway. (2013). *Expansion of the RCAF and the British Commonwealth Air Training Plan*. Retrieved August 7 2013 from <http://www.cmhg.gc.ca/cmh/page-663-eng.asp?flash=1>

Canadian Wings. (2012). *The Battle of Britain*. Retrieved August 7 2013 from http://www.canadianwings.com/Battle%20of%20Britain/bob_canadians.php

CBC Learning. (2001). *The Battle of Britain*. Retrieved August 8, 2013 from <http://www.cbc.ca/history/EPISCONTENTSE1EP14CH1PA1LE.html>

CBC News. (2010) *Disaster Relief: Canada's Rapid Response Team*. Retrieved March 25, 2013 from <http://www.cbc.ca/news/canada/story/2010/01/13/f-disasters-military-dart.html>

Commonwealth Air Training Plan Museum (2010) *Virtual Tour*. Retrieved August 7, 2013 from <http://www.airmuseum.ca/tourtext.html>

The Globe and Mail. (2013) *Domestic Terrorism becoming a Greater Concern for Canadian Spy Agency*. Retrieved March 25, 2013 from <http://www.theglobeandmail.com/news/politics/domestic-terrorism-becoming-a-greater-concern-for-canadian-spy-agency/article8478299/>

The Globe and Mail. (2013) *MacKay Orders Revamp of Canadian Forces Command*. Retrieved March 25, 2013 from <http://www.theglobeandmail.com/news/politics/mackay-orders-revamp-of-canadian-forces-command/article4104781/>

History Learning Site (2000-2013) *Battle of Britain*. Retrieved September 17, 2013 from http://www.historylearningsite.co.uk/battle_of_britain.htm

The Huffington Post. (2013) *Second Canadian Confirmed Killed in Algeria Attack*. Retrieved March 25, 2013 from http://www.huffingtonpost.ca/2013/03/23/canadian-algeria-dead-attack_n_2941532.html

National Defence and the Canadian Forces. (2013) *Canada First Defence Strategy*. Retrieved March 25, 2013 from <http://www.forces.gc.ca/site/pri/first-premier/missions-eng.asp>

National Geographic. (2012) *9:11 25 Indelible Pictures*. Retrieved March 25, 2013 from http://news.nationalgeographic.com/news/2011/09/pictures/110908-about-911-september-9-11-twin-world-trade-center-towers-indelible/#/september-9-11-attacks-anniversary-ground-zero-world-trade-center-pentagon-flight-93-second-airplane-wtc_39997_600x450.jpg

NATO Website. (N.D.) *NATO background information*. Retrieved March 26, 2013, from <http://www.nato.int/cps/en/natolive/index.htm>

NORAD Website. (N.D.) *NORAD background information*. Retrieved March 26, 2013, from <http://www.norad.mil/about/index.html>

NORAD News. (2013) *CONR to Protect the Skies during Super Bowl XLVII*. Retrieved March 25, 2013 from <http://www.norad.mil/News/2013/020113.html>

Public Safety Canada. (2010) *Air India Flight 182 – Background*. Retrieved March 25, 2013 from <http://www.publicsafety.gc.ca/prg/ns/ai182/ai-bk-eng.aspx>

School History. (2012) *Battle of Britain*. Retrieved September 17, 2013 from <http://www.schoolhistory.co.uk/year9links/wwii/battleofbritain.pdf>

Show Canada. (2010) *Vancouver 2010 Winter Olympics – Totem*. Retrieved March 25, 2013 from <http://www.show-canada.com/portfolio/2010-vancouver-olympics-totem/>

UN Website. (N.D.) *UN background information*. Retrieved March 26, 2013, from <http://www.un.org/fr/>

Veterans.gc.ca. (2013). *The Capture of Vimy Ridge – Veterans Affairs Canada*. Retrieved March 26, 2013 from <http://www.veterans.gc.ca/eng/history/firstwar/vimy/vimy5>

Veterans.gc.ca. (2013). *British Commonwealth Air Training Plan*. Retrieved September 12, 2013 from <http://www.veterans.gc.ca/eng/remembrance/history/second-world-war/bcatp/page1>

WarMuseum.ca. (2013). *WarMuseum.ca - The Battle of Vimy Ridge April 9-12, 1917 - The First World War*. Retrieved March 26, 2013 from http://www.warmuseum.ca/cwm/exhibitions/vimy/index_e.shtml

WarMuseum.ca (2004). *Map of Vimy Ridge*. Retrieved March 13, 2013, from http://www.warmuseum.ca/cwm/exhibitions/vimy/vimy_maps_e.shtml
http://www.warmuseum.ca/cwm/exhibitions/chrono/1931air_training_plan_e.shtml

WarMuseum.ca. (2013). *British Air Plan*. Retrieved March 13, 2013, from http://www.warmuseum.ca/cwm/exhibitions/newspapers/canadawar/britishairplan_e.shtml

Wikipedia.com. (2013). *Battle of Vimy Ridge*. Retrieved March 26, 2013 from http://en.wikipedia.org/wiki/Battle_of_Vimy_Ridge#Background

THIS PAGE INTENTIONALLY LEFT BLANK

CANADIAN ARMED FORCES (CAF) HISTORY

OBJECTIVE: This activity is designed to familiarize the cadets with aspects of the history of the CAF.

TIME: 30 min

TRAINING LEVEL: 1–2

PRE-ACTIVITY INSTRUCTIONS:

1. Assign an instructor to this activity.
2. Photocopy the Second Boer War, World War I, World War II and the Korean War sheets located at Appendix 2 and Statements for the History of the CAF Timeline located at Appendix 3.
3. Cut out the statements.
4. Gather the required resources:
 - (a) Whiteboard or flipchart,
 - (b) Markers, and
 - (c) Sticky tack or tape.
5. Draw the timeline as shown at Appendix 1 on a whiteboard or flipchart.

ACTIVITY INSTRUCTIONS:

1. Have the cadets list what they know about CAF history on a whiteboard or flipchart. Prepare questions that may help stimulate the cadets' thinking (eg, In what wars has Canada participated? How many World Wars have there been?).
2. Have the cadets place the Second Boer War, World War I, World War II and Korean War sheets on the correct dates on the timeline. The answer key is located at Appendix 4.
3. Give a statement to each cadet.
4. Have the cadets place their statement with the correct event and element. The answer key is located at Appendix 5.
5. Have each cadet indicate one fact they learned about the history of the CAF.



For more information about the Second Boer War, World War I, World War II and the Korean War, visit the Veterans Affairs website : <http://www.veterans.gc.ca/eng/> > YOUTH & EDUCATORS > CANADIAN MILITARY HISTORY.

THIS PAGE INTENTIONALLY LEFT BLANK

HISTORY OF THE CAF TIMELINE

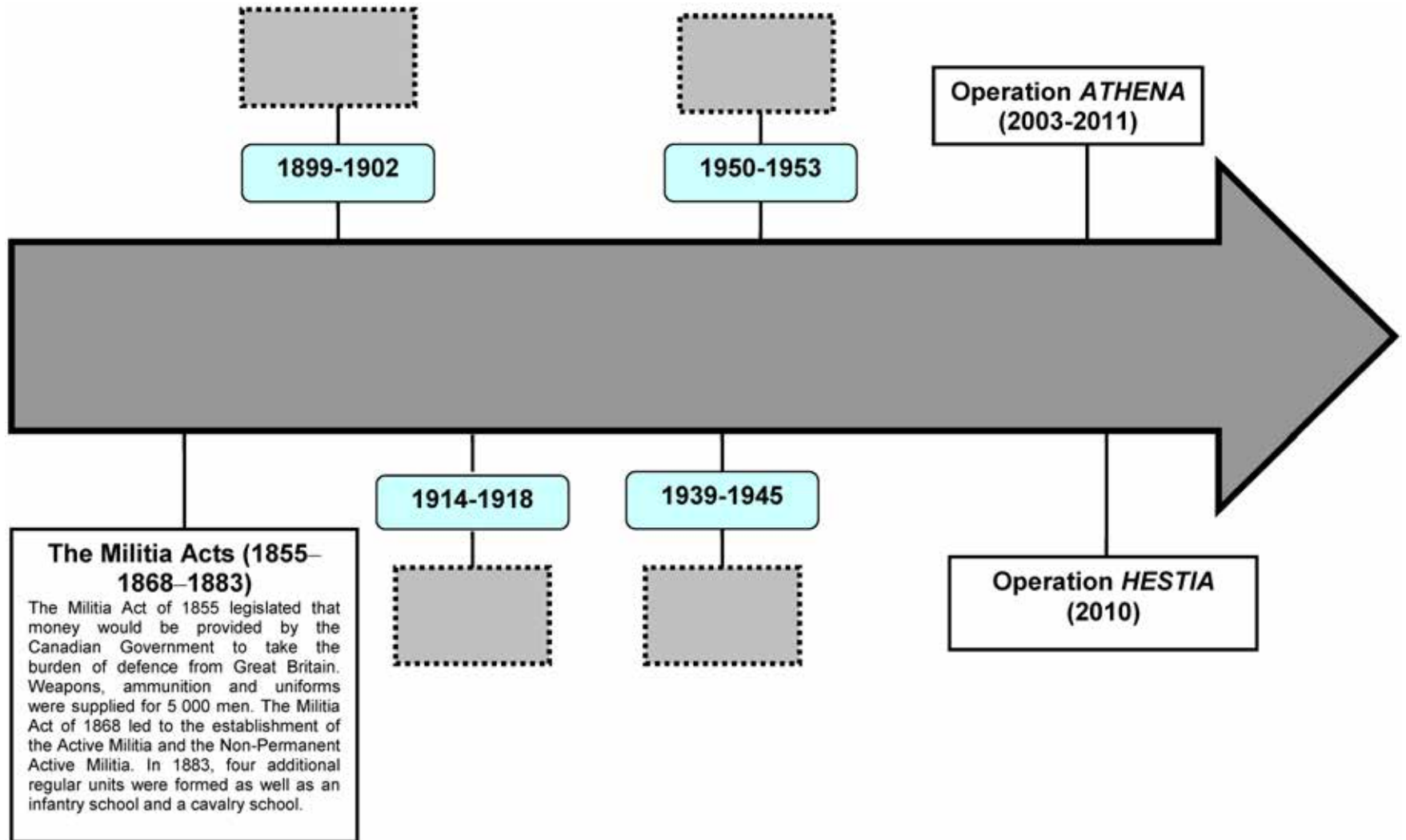

THIS PAGE INTENTIONALLY LEFT BLANK

Second Boer War



Canada's first overseas participation in a war. Of the 7 500 Canadians who served, 242 died. There were more casualties due to disease than military action. The Royal Canadian Regiment (RCR) received its first battle honour at Paarderburg, South Africa.

World War I



During World War I, the Federal Government decided to conscript young men. Of the 600 000 men who enlisted in World War I, 60 000 died and 172 000 were wounded.

World War II



The Dutch Royal family sought refuge in Canada while the Netherlands was occupied by Germany. Princess Juliana of the Netherlands, the heir to the throne, gave birth to her third child, Princess Margriet at the Ottawa Civic Hospital. To ensure Dutch citizenship, the Canadian Parliament passed a special law declaring the hospital room 'extraterritorial'. The day after the new princess was born, the Dutch flag was flown on the Peace Tower, the only time a foreign flag has ever flown atop Canada's Parliament Buildings.

The First Canadian Army was responsible for liberating much of the Netherlands from German occupation. To thank Canadians, the people of the Netherlands sent 100 000 hand-picked tulip bulbs to Canada, which were planted on Parliament Hill and along Queen Elizabeth Drive. The year after, Princess Juliana sent a gift of 20 000 tulip bulbs. Every year, Ottawa receives 10 000 tulip bulbs from the Dutch Royal family and plants them as a symbol of peace, freedom and international friendship.

Korean War



During the Korean War, Canada's contribution was larger than most United Nations (UN) countries, in proportion to its population. More than 22 000 Canadians served of which 300 died and 1 200 were wounded.

STATEMENTS FOR THE HISTORY OF THE CAF TIMELINE

<p>At this time, the Royal Canadian Navy (RCN) was not yet established.</p>
<p>At this time, the Royal Canadian Air Force (RCAF) was not yet established.</p>
<p>Responding to an imperial plea, Prime Minister Wilfrid Laurier sent a Canadian contingent of about 1 000 Royal Canadian Regiment (RCR) soldiers overseas.</p>
<p>The Royal Canadian Navy played a minor role in the fighting at sea and was ineffective against the German threat, especially when U-boat activity started.</p>
<p>At the beginning of this war, Canada had neither pilots nor aircraft. At the end of this war, over 800 decorations were awarded to Canadian airmen. Three airmen, Major WA Bishop, Major R Collishaw and Major WG Baker, received the Victoria Cross (VC).</p>
<p>The Germans introduced and widely used poison gas during this war.</p>
<p>The Battle of the Atlantic happened during this war. This battle is commemorated every year on the first Sunday in May.</p>
<p>During this war, crews painted art on the noses of planes. It was a source of pride, inspiration, esprit de corps and good luck for the crew. At the time, Air Cadets received preliminary instruction and many of them served with distinction in operational squadrons.</p>
<p>Canadian soldiers participated in the Dieppe Raid. Over 900 Canadians were killed and almost 2 000 were captured. Canada was the only army to achieve its objective on D-Day during this war.</p>
<p>During this conflict, the Royal Canadian Navy was the first branch of the Canadian Armed Forces to provide aid.</p>
<p>During this combat, pilots officially destroyed at least nine hostile aircraft and damaged eight. They also destroyed several locomotives, railroad cars, and trucks.</p>
<p>During this conflict the 2nd Battalion of the Princess Patricia's Canadian Light Infantry (PPCLI) was awarded the United States Presidential Unit Citation and the Republic of Korea Presidential Unit Citation for their defence of the Kapyong Valley.</p>

THIS PAGE INTENTIONALLY LEFT BLANK

HISTORY OF THE CAF TIMELINE – ANSWER KEY

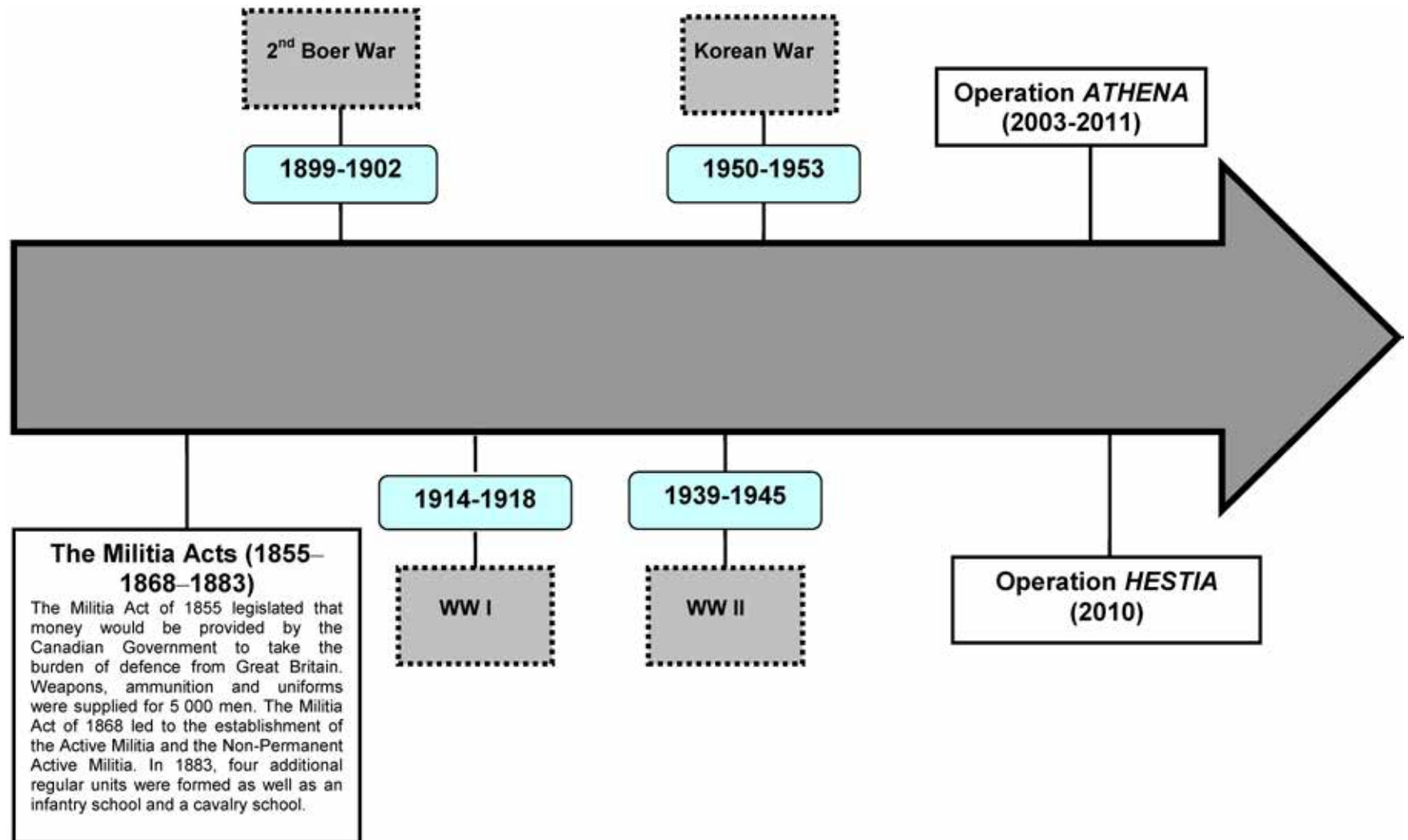

THIS PAGE INTENTIONALLY LEFT BLANK

STATEMENTS FOR THE HISTORY OF THE CANADIAN FORCES TIMELINE – ANSWER KEY

At this time, the Royal Canadian Navy (RCN) was not yet established.	2nd Boer War Navy
At this time, the Royal Canadian Air Force (RCAF) was not yet established.	2nd Boer War Air
Responding to an imperial plea, Prime Minister Wilfrid Laurier sent a Canadian contingent of about 1 000 Royal Canadian Regiment (RCR) soldiers overseas.	2nd Boer War Army
The Royal Canadian Navy played a minor role in the fighting at sea and was ineffective against the German threat, especially when U-boat activity started.	WW I Navy
At the beginning of this war, Canada had neither pilots nor aircraft. At the end of this war, over 800 decorations were awarded to Canadian airmen. Three airmen, Major WA Bishop, Major R Collishaw and Major WG Baker, received the Victoria Cross (VC).	WW I Air
The Germans introduced and widely used poison gas during this war.	WW I Army
The Battle of the Atlantic happened during this war. This battle is commemorated every year on the first Sunday in May.	WW II Navy
During this war, crews painted art on the noses of planes. It was a source of pride, inspiration, esprit de corps and good luck for the crew. At the time, Air Cadets received preliminary instruction and many of them served with distinction in operational squadrons.	WW II Air
Canadian soldiers participated in the Dieppe Raid. Over 900 Canadians were killed and almost 2 000 were captured. Canada had the only army to achieve its objective on D-Day during this war.	WW II Army
During this conflict, the RCN was the first branch of the CAF to provide aid.	Korean War Navy
During this war, pilots destroyed nine hostile aircraft, and damaged eight. They also destroyed several locomotives, railroad cars, and trucks.	Korean War Air
During this conflict the 2nd Battalion of the Princess Patricia's Canadian Light Infantry (PPCLI) was awarded the United States Presidential Unit Citation and the Republic of Korea Presidential Unit Citation for their defence of the Kapyong Valley.	Korean War Army

THIS PAGE INTENTIONALLY LEFT BLANK

CANADIAN ARMED FORCES (CAF) HISTORY

OBJECTIVE: This activity is designed to familiarize the cadets with aspects of the history of the CAF.

TIME: 30 min

TRAINING LEVEL: 1–4

PRE-ACTIVITY INSTRUCTIONS:

1. Assign an instructor to this activity.
2. Print the *Canada Remembers Times* (2011) at <http://www.veterans.gc.ca> > ENGLISH > YOUTH & EDUCATORS > CANADA REMEMBERS TIMES NEWSPAPER > PAST EDITION > 2011 > PDF VERSION (http://www.veterans.gc.ca/public/pages/activities/youthcorner/crtimes/pdf/crtimes_2011.pdf) for each cadet.
3. Photocopy the Questions handout located at Appendix 1 and Key Word Sheet located at Appendix 2 for each cadet.
4. Gather the required resources:
 - (a) Pens / pencils,
 - (b) Highlighters, and
 - (c) Whiteboard or flipchart.



Another version of the *Canada Remembers Times* may be selected. Create a key word sheet and questions.

ACTIVITY INSTRUCTIONS:

1. Have the cadets list what they know about CAF History, honours, awards and major engagements / operations. Prepare questions that may help stimulate the cadets' thinking (eg, In what wars has Canada participated? How many World Wars have there been? In what North Atlantic Treaty Organization (NATO) or United Nations (UN) peacekeeping operations has Canada been involved?).
2. Provide each cadet with the *Canada Remembers Times* (2011), the Questions handout, the Key Word Sheet, pen and highlighter.
3. Have the cadets read the *Canada Remembers Times* (2011) and write the answers to the questions on the Key Word Sheet. The Key Word Sheet—Answer Key is located at Appendix 3.

THIS PAGE INTENTIONALLY LEFT BLANK

CANADA REMEMBERS TIMES (2011)

QUESTIONS

1. Which decoration did Lorne Green receive?
2. Who started as an Air Cadet and became the first woman to be part of the famous Snowbirds Precision Flying Team?
3. What is celebrated every year on July 1st?
4. What was the name of the Canadian hospital ship that was torpedoed off the coast of Ireland by a German submarine?
5. Which terrorist group hijacked four American airliners, attacking the World Trade Center and the Pentagon on September 11, 2001?
6. What was the nickname for Hill 355?
7. Who was the journalist that was killed by a roadside bomb south of Kandahar City in 2009?
8. Who died in 1950 and was posthumously awarded the Canadian Forces Medallion for Distinguished Service in 2010?
9. During World War II, Canadian reduced their consumption of food and goods. Meat, eggs, sugar, chocolate and _____ were a luxury.
10. Which was one of the bloodiest chapters of World War I?
11. Which building was dedicated to Canadians who died during World War I?
12. Where was 'Agent 50' born?
13. Who became the first widower to receive the Memorial Cross?
14. Who was known as 'Ronnie the Bren Gun Girl' during World War II?
15. During the Korean War, where did Léo Major lead a platoon that successfully repelled a massive enemy attack?
16. What kind of clearance were CAF members doing in Cambodia?
17. What did René Levesque do for the U.S. Army during World War II?
18. What were German submarines called during World War II?
19. Who was the first Canadian to be awarded the Royal Red Cross Medal?
20. In which war did Canadians serve between 1899 and 1902?
21. The Memorial Cup is awarded each year in which sport?

THIS PAGE INTENTIONALLY LEFT BLANK

THIS PAGE INTENTIONALLY LEFT BLANK

KEY WORD SHEET – ANSWER KEY

1					O	r	d	e	r	o	f	C	a	n	a	d	a			
2					M	a	r	y	s	e	C	A	r	m	i	c	h	a	e	l
3										C	a	N	a	d	a	D	a	y		
4	L	l	a	n	d	o	v	e	r	y	C	A	s	t	l	e				
5						a	l	-	Q	a	e	D	a							
6					L	i	t	t	l	e	G	I	b	r	a	l	t	a	r	
7			M	i	c	h	e	l	l	e	L	A	n	g						
8		J	e	r	e	m	i	a	h	J	o	N	e	s						
9									C	o	f	F	e	e						
10										S	O	m	m	e						
11			P	e	a	c	e	T	o	w	e	R								
12									V	a	n	C	o	u	v	e	r			
13					J	a	s	o	n	B	E	a	n							
14		V	e	r	o	n	i	c	a	F	o	S	t							
15												H	i	l	l	3	5	5		
16						L	a	n	d	m	I	n	e							
17			W	a	r	c	o	r	r	e	S	p	o	n	d	e	n	t		
18							U	b	o	a	T	s								
19			G	e	o	r	g	i	n	a	P	O	p	e						
20					S	o	u	t	h	A	f	R	i	c	a	n	W	a	r	
21						H	o	c	k	e	Y									

THIS PAGE INTENTIONALLY LEFT BLANK

CANADIAN ARMED FORCES (CAF) HISTORY

OBJECTIVE: This activity is designed to familiarize the cadets with aspects of the history of the CAF.

TIME: 15 min

LEVEL: 1–2

PRE-ACTIVITY INSTRUCTIONS:

1. Assign an instructor to this learning station.
2. Gather the required resources:
 - (a) copies of the images located at Appendices 1–3,
 - (b) paper, and
 - (c) pens / pencils.



Images other than those provided may be used.

ACTIVITY INSTRUCTIONS:

1. Distribute the World War One image located at Appendix 1 to the cadets.
2. Have the cadets look at the image and reflect on it in silence for approximately 30 seconds.
3. Have the cadets respond to two or more of the following questions in writing individually:
 - (a) What are your initial thoughts about this image?
 - (b) What mood does this image convey?
 - (c) What do you know about this war?
 - (d) What does this image tell you about this war?
 - (e) Imagine you are the photographer—what else is going on around you?
4. Have the cadets share their responses to the questions with a partner.
5. Repeat Steps 1–4 for the images at Appendices 2 and 3.



For more information about the Second Boer War, World War I, World War II and the Korean War, visit the Veterans Affairs website: <http://www.veterans.gc.ca/eng/> > YOUTH & EDUCATORS > CANADIAN MILITARY HISTORY.

THIS PAGE INTENTIONALLY LEFT BLANK

Canadian Army advancing behind a British tank during the Battle of Vimy Ridge in 1917. The battle took place in France during World War I.

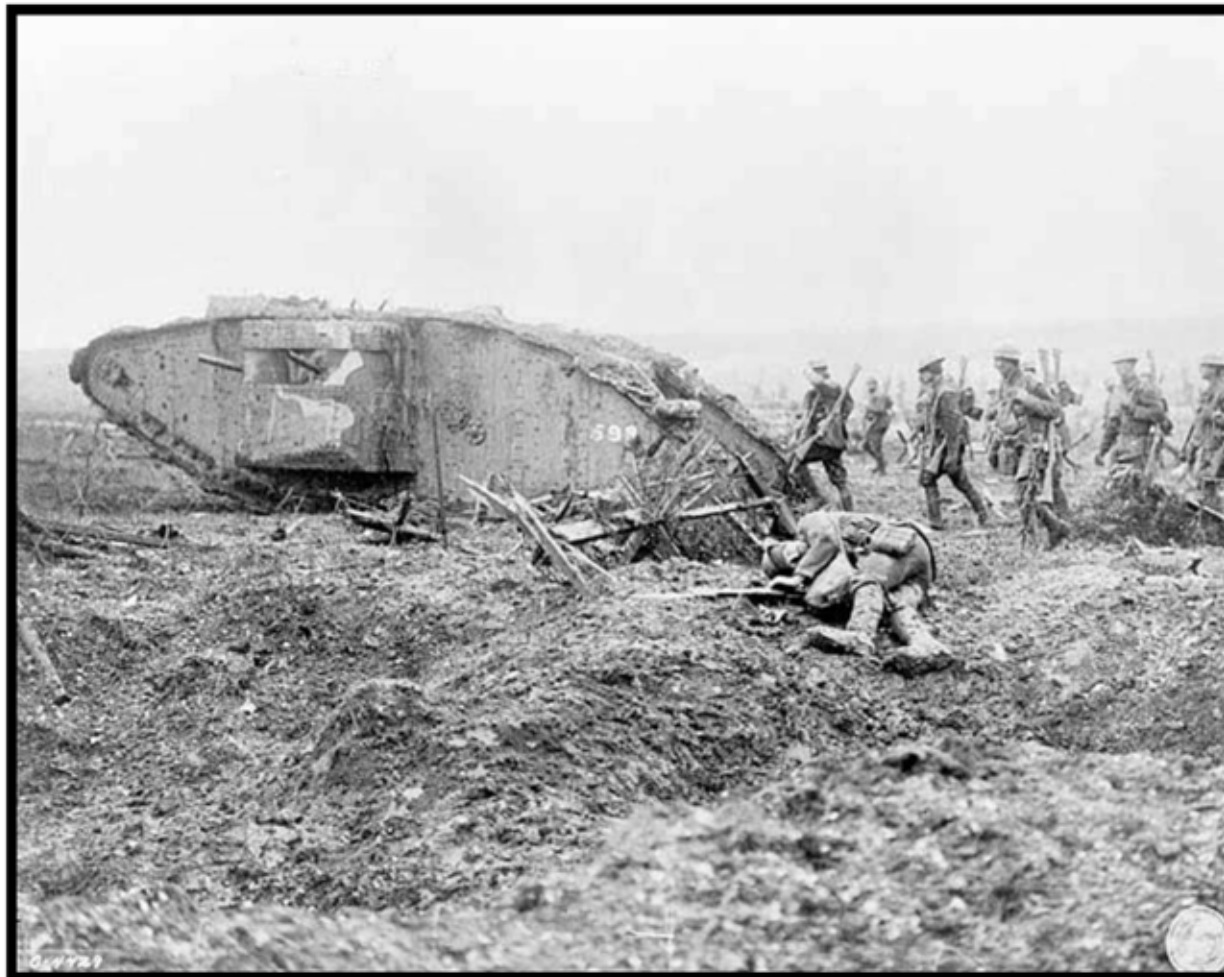

THIS PAGE INTENTIONALLY LEFT BLANK

.....

Buffalo amphibious vehicles taking Canadians across the Scheldt in Zeeland, Belgium during World War II.

.....



THIS PAGE INTENTIONALLY LEFT BLANK

.....

Canadians waiting for orders to move against the communist forces during the Korean War in 1951.

.....



THIS PAGE INTENTIONALLY LEFT BLANK

BATTLE OF THE ATLANTIC

OBJECTIVE: The aim of this learning station is to familiarize the cadets with the Battle of the Atlantic.

TIME: 30 min

TRAINING LEVEL: 1–2

PRE-ACTIVITY INSTRUCTIONS:

1. This activity may be assigned an instructor or be self-directed by the cadets.
2. Photocopy the Battleship Board Game, located at Appendix 1, for each cadet.
3. Post the Battleship Rules, located at Appendix 2, at each station.
4. Photocopy Battleship Questions A, located at Appendix 3, for half the group and Battleship Questions B, located at Appendix 4, for the other half of the group.
5. Photocopy the Battle of the Atlantic handout, located at Appendix 5, for each cadet.
6. Gather the required resources:
 - (a) Pencils / Pens, and
 - (b) Highlighters.

ACTIVITY INSTRUCTIONS:

1. Divide the cadets into pairs.
2. Distribute the Battle of the Atlantic handout to each cadet.
3. Distribute the Battleship Questions A to one cadet and the Battleship Questions B to the other cadet.
4. Have the cadets read the Battleship Rules and play.



For more information about the Battle of the Atlantic, visit the Veterans Affairs website:
<http://www.veterans.gc.ca/eng/> > YOUTH & EDUCATORS > CANADIAN MILITARY HISTORY > SECOND WORLD WAR > THE BATTLE OF THE ATLANTIC.

THIS PAGE INTENTIONALLY LEFT BLANK

THIS PAGE INTENTIONALLY LEFT BLANK

Battleship Rules

- 1** Review the Battle of the Atlantic handout to make sure you are able to answer the question.
- 2** You need two grids to play: **Enemy Attacks** and **Your Attacks**. On the **Enemy Attacks** grid, arrange your boats and record the enemy shots. On the **Your Attacks** grid, record your own shots.
- 3** Before the game starts, arrange your ships on the **Enemy Attacks** grid with a highlighter. Make sure each ship occupies the specified number of squares on the grid, as per the table below. They can be arranged horizontally or vertically, and only one ship can occupy a given square.

Type of ship	Size
Aircraft carrier	5 squares
Battleship	4 squares
Submarine	3 squares
Destroyer	3 squares
Patrol boat	2 squares

- 4** Once the ships have been positioned, the game can begin! For each turn, announce which square you are attacking and mark it on the **Your Attack** grid with a pen or a pencil. The squares are identified by a letter and a number. For example: 'I attack D3!'
- 5** Your partner announces whether or not the square is occupied by a ship and marks it on the **Enemy Attacks** grid.
- 6** Your partner picks a square and you tell them whether or not the square is occupied by a ship and mark it on the **Enemy Attacks** grid.
- 7** When all the squares for a ship have been filled, the cadet whose ship has been 'hit' will ask the other player the question associated with the specific ship. If correct, the cadet is awarded the 'hit'. The game continues until all the squares for the ships have been filled.

THIS PAGE INTENTIONALLY LEFT BLANK

Battleship Questions A

Type of ship	Questions & Answers
Aircraft carrier (5 squares)	How many vessels did the Royal Canadian Navy (RCN) begin the war with? 13 vessels
Battleship (4 squares)	How many seconds did it take for a U-boat to dive? 30 seconds
Submarine (3 squares)	How many members of the RCN died during the Battle of the Atlantic? Approximately 2 000
Destroyer (3 squares)	In the month of June 1941, how many tons of Allied cargo was lost to U-boats? Over 500 000 tons
Patrol boat (2 squares)	During which war did the Battle of the Atlantic take place? World War II

THIS PAGE INTENTIONALLY LEFT BLANK

Battleship Questions B

Type of ship	Questions & Answers
Aircraft carrier (5 squares)	At the end of the war, how many fighting ships did the Royal Canadian Navy (RCN) have? 373 fighting ships
Battleship (4 squares)	How many months were U-boats capable of remaining away from port? Three months at least
Submarine (3 squares)	How many vessels of the RCN were sunk during the Battle of the Atlantic? 24 vessels
Destroyer (3 squares)	How many U-boats did Canadian aircraft and ships sink? 50 U-boats
Patrol boat (2 squares)	How long did the Battle of the Atlantic last? More than 6 years

THIS PAGE INTENTIONALLY LEFT BLANK

Battle of the Atlantic



German Submarines

- Named U-boats.
- Took 30 seconds to dive.
- Capable of remaining at sea for at least 3 months.



Royal Canadian Navy (RCN)

- The Battle of the Atlantic started September 1939.
- At the end of the war, the RCN had 373 fighting ships.
- In June 1941, over 500 000 tons of Allied cargo were lost to U-boats.
- During the BOA, 24 RCN vessels were sunk.
- Canadian aircraft and ships sank 50 U-boats during the Battle of the Atlantic.



Tragic Loss

During the Battle of the Atlantic, approximately 2 000 members of the RCN lost their lives.

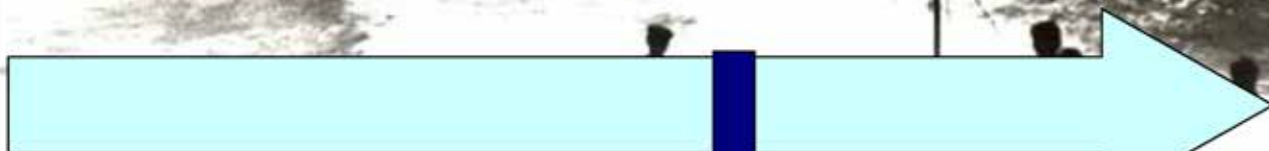

1939 1945

2nd Boer War

WW I

WW II

Korean War

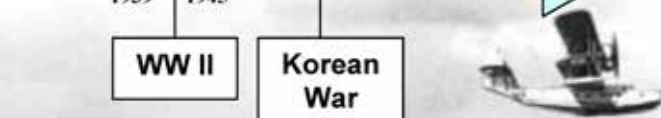

THIS PAGE INTENTIONALLY LEFT BLANK

BATTLE OF VIMY RIDGE

OBJECTIVE: The aim of this learning station is to familiarize the cadets with the Battle of Vimy Ridge.

TIME: 30 min

TRAINING LEVEL: 1–2

PRE-ACTIVITY INSTRUCTIONS:

1. This activity may be assigned an instructor or be self-directed by the cadets.
2. Photocopy the Battletank Board Game, located at Appendix 1, for each cadet.
3. Post the Battletank Rules, located at Appendix 2, at each station.
4. Photocopy Battletank Questions A, located at Appendix 3, for half the group and Battletank Questions B, located at Appendix 4, for the other half of the group.
5. Photocopy the Battle of Vimy Ridge handout, located at Appendix 5, for each cadet.
6. Gather the required resources:
 - (a) Pencils / Pens, and
 - (b) Highlighters.

ACTIVITY INSTRUCTIONS:

1. Divide the cadets into pairs.
2. Distribute the Battle of Vimy Ridge handout to each cadet.
3. Distribute the Battletank Questions A to one cadet and the Battletank Questions B to the other cadet.
4. Have the cadets read the Battletank Rules and play.



For more information about the Battle of Vimy Ridge, visit the Veterans Affairs website:
<http://www.veterans.gc.ca/eng/> > YOUTH & EDUCATORS > CANADIAN MILITARY HISTORY > FIRST WORLD WAR > THE BATTLE OF VIMY RIDGE.

THIS PAGE INTENTIONALLY LEFT BLANK

THIS PAGE INTENTIONALLY LEFT BLANK

Battletank Rules

- 1** Review the poster to make sure you are able to answer the questions.
- 2** You need two grids to play: **Enemy Attacks** and **Your Attacks**. On the **Enemy Attacks** grid, arrange your vehicles and record the enemy shots. On the **Your Attacks** grid, record your own shots.
- 3** Before the game starts, arrange your vehicles on the **Enemy Attacks** grid with a highlighter. Make sure each vehicle occupies the specified number of squares on the grid, as per the table below. They can be arranged horizontally or vertically, and only one vehicle can occupy a given square.

Type of vehicle	Size
Tank	5 squares
Light Armoured Vehicle (LAV)	4 squares
Heavy Logistic Vehicle Weight (HLVW)	3 squares
Medium Logistic Vehicle Weight (MLVW)	3 squares
G Wagen	2 squares

- 4** Once the vehicles have been positioned, the game can begin! For each turn, announce which square you are attacking and mark it on the **Your Attacks** grid with a pen or a pencil. The squares are identified by a letter and a number. For example: 'I attack D3!'
- 5** Your partner announces whether or not the square is occupied by a vehicle and marks it on the **Enemy Attacks** grid.
- 6** Your partner picks a square and you tell them whether or not the square is occupied by a vehicle and mark it on the **Enemy Attacks** grid.
- 7** When all the squares for a vehicle have been filled, the cadet whose vehicle has been 'hit' will ask the other player the question associated with the specific vehicle. If correct, the cadet is awarded the 'hit'. The game continues until all the squares for the vehicles have been filled.

THIS PAGE INTENTIONALLY LEFT BLANK

Battletank Questions A

Type of vehicle	Questions & Answers
Tank (5 squares)	After the Battle of Vimy Ridge, what treaty did Canada sign to mark the end of the war? Treaty of Versailles
LAV (4 squares)	How long did the Battle of Vimy Ridge last? 3 days
HLVW (3 squares)	How many Canadians lost their lives during the Battle of Vimy Ridge? 3 600 Canadians
MLVW (3 squares)	Who had tried and failed to take Vimy in 1915? The French
G Wagen (2 squares)	During which war did the Battle of Vimy Ridge take place? World War I

THIS PAGE INTENTIONALLY LEFT BLANK

Battletank Questions B

Type of vehicle	Questions & Answers
Tank (5 squares)	What is the name of the Memorial that sits on top of Hill 145? The Canadian National Vimy Memorial
LAV (4 squares)	How long did it take for the allies to prepare for the Battle of Vimy Ridge? All winter
HLVW (3 squares)	How many Canadians fought during the Battle of Vimy Ridge? 100 000 Canadians
MLVW (3 squares)	Vimy Ridge was one of the most important elements of the defence system of which country? Germany
G Wagen (2 squares)	In which country is Vimy Ridge located? France

THIS PAGE INTENTIONALLY LEFT BLANK

Battle of Vimy Ridge

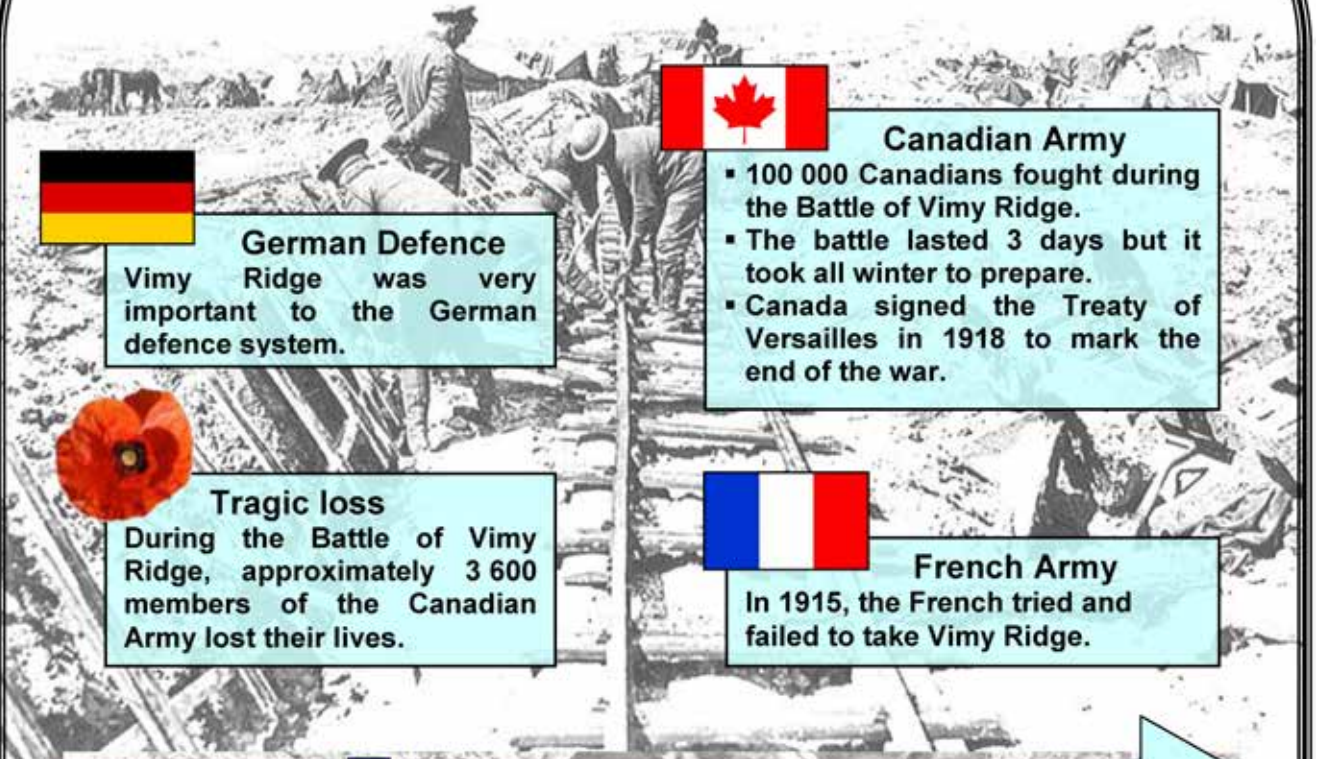

German Defence
Vimy Ridge was very important to the German defence system.



Canadian Army

- 100 000 Canadians fought during the Battle of Vimy Ridge.
- The battle lasted 3 days but it took all winter to prepare.
- Canada signed the Treaty of Versailles in 1918 to mark the end of the war.



Tragic loss
During the Battle of Vimy Ridge, approximately 3 600 members of the Canadian Army lost their lives.



French Army
In 1915, the French tried and failed to take Vimy Ridge.



Map of Vimy Ridge



The Canadian National Vimy Memorial

THIS PAGE INTENTIONALLY LEFT BLANK

BATTLE OF BRITAIN

OBJECTIVE: The aim of this learning station is to familiarize the cadets with the Battle of Britain.

TIME: 30 min

TRAINING LEVEL: 1–2

PRE-ACTIVITY INSTRUCTIONS:

1. This activity may be assigned an instructor or be self-directed by the cadets.
2. Photocopy the Battleplane Board Game, located at Appendix 1, for each cadet.
3. Post the Battleplane Rules, located at Appendix 2, at each learning station.
4. Photocopy Battleplane Questions A, located at Appendix 3, for half the group and Battleplane Questions B, located at Appendix 4, for the other half of the group.
5. Photocopy the Battle of Britain handout, located at Appendix 5, for each cadet.
6. Gather the required resources:
 - (a) Pencil / Pen, and
 - (b) Highlighter.

ACTIVITY INSTRUCTIONS:

1. Divide the cadets into pairs.
2. Distribute the Battle of Britain handout to each cadet.
3. Distribute the Battleplane Questions A to one cadet and the Battletank Questions B to the other cadet.
4. Have the cadets read the Battleplane Rules and play.



For more information about the Battle of Britain, visit the Veterans Affairs website : <http://www.veterans.gc.ca/eng/> > YOUTH & EDUCATORS > CANADIAN MILITARY HISTORY > SECOND WORLD WAR > CANADA AND THE SECOND WORLD WAR > THE BATTLE OF BRITAIN.

THIS PAGE INTENTIONALLY LEFT BLANK

THIS PAGE INTENTIONALLY LEFT BLANK

Battleplane Rules

- 1** Review the poster to make sure you are able to answer the questions.
- 2** You need two grids to play: **Enemy Attacks** and **Your Attacks**. On the **Enemy Attacks** grid, arrange your planes and record the enemy shots. On the **Your Attacks** grid, record your own shots.
- 3** Before the game starts, arrange your planes on the **Enemy Attacks** grid with a highlighter. Make sure each plane occupies the specified number of squares on the grid, as per the table below. They can be arranged horizontally or vertically, and only one plane can occupy a given square.

Type of plane	Size
B17 Flying Fortress	5 squares
AVRO Lancaster	4 squares
Hawker Hurricane	3 squares
Mustang	3 squares
Spitfire	2 squares

- 4** Once the planes have been positioned, the game can begin! For each turn, announce which square you are attacking and mark it on the **Your Attacks** grid with a pen or a pencil. The squares are identified by a letter and a number. For example: 'I attack D3!'
- 5** Your partner announces whether or not the square is occupied by a plane and marks it on the **Enemy Attacks** grid.
- 6** Your partner picks a square and you tell them whether or not the square is occupied by a plane and mark it on the **Enemy Attacks** grid.
- 7** When all the squares for a plane have been filled, the cadet whose plane has been 'hit' will ask the other player the question associated with the specific plane. If correct, the cadet is awarded the 'hit'. Game continues until all the squares for the planes have been filled.

THIS PAGE INTENTIONALLY LEFT BLANK

Battleplane Questions A

Type of plane	Questions & Answers
B17 Flying Fortress (5 squares)	What kind of tactic did the German's use to try to gain air superiority over the Royal Air Force (RAF)? Blitzkrieg tactics
AVRO Lancaster (4 squares)	At the beginning of the Battle of Britain, what was the German Air Force attacking? They were attacking the radar stations and bombing the airfields
Hawker Hurricane (3 squares)	Who won the Battle of Britain? Allied Forces
Mustang (3 squares)	Who was the battle between? Allied Forces and Axis Powers
Spitfire (2 squares)	During which war did the Battle of Britain take place? World War II

THIS PAGE INTENTIONALLY LEFT BLANK

Battleplane Questions B

Type of plane	Questions & Answers
B17 Flying Fortress (5 squares)	During the war that included the Battle of Britain, Canada agreed to provide facilities and training for airmen from the Commonwealth. What was the name of this deal? The British Commonwealth Air Training Plan
AVRO Lancaster (4 squares)	Toward the end of the Battle of Britain, what was the German Air Force attacking? They were attacking major cities
Hawker Hurricane (3 squares)	How many Canadian pilots lost their lives in this battle? 23 Canadian pilots
Mustang (3 squares)	What was the name of the German Air Force? Luftwaffe
Spitfire (2 squares)	Who wanted to invade Britain? The Germans

THIS PAGE INTENTIONALLY LEFT BLANK

Battle of Britain



German Air Force

- Part of the Axis Powers.
- Named Luftwaffe.
- Used Blitzkrieg tactics to gain air superiority.
- At the beginning of the battle, they attacked radar stations and bombed airfields.
- Toward the end of the battle, they attacked major cities.



Royal Air Force (RAF)

- Part of the Allied Forces.
- The British Commonwealth Air Training Plan was signed by Canada during the war. Canada agreed to provide facilities, training, and personnel for airmen from the Commonwealth.



Tragic loss

During the Battle of Britain, approximately 23 Canadian pilots lost their lives.

ALLIED FORCES
VS
AXIS POWERS



2nd Boer War

WW I

WW II

Korean War

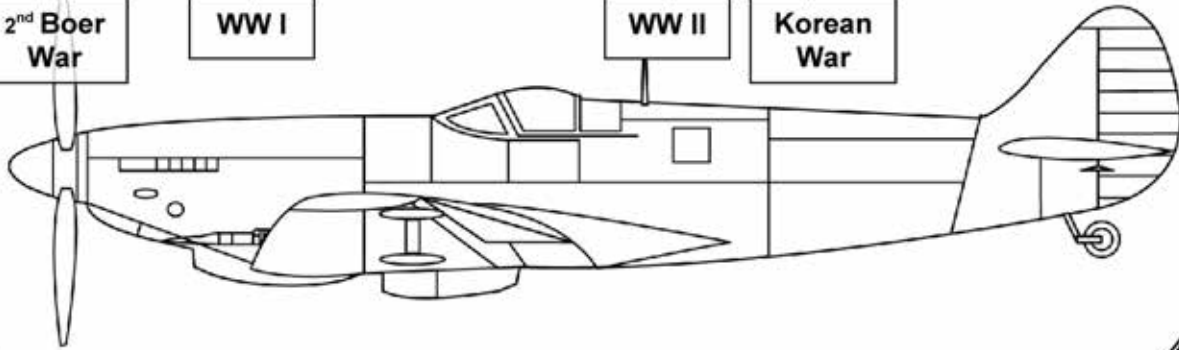

THIS PAGE INTENTIONALLY LEFT BLANK

BATTLE OF THE ATLANTIC

OBJECTIVE: The aim of this learning station is to familiarize the cadets with the Battle of the Atlantic.

TIME: 30 min

TRAINING LEVEL: 3-4

PRE-ACTIVITY INSTRUCTIONS:

1. Assign an instructor to this activity.
2. Photocopy the Canada Remembers the Battle of the Atlantic handout, located at Appendix 1, for each cadet.
3. Gather the required resources: 2 noisemakers (eg, bell, bicycle horn, kazoo).

ACTIVITY INSTRUCTIONS:



This activity is designed to be presented in a “game show” format. If possible, have a small prize available to the winning team.

1. Divide the cadets into two teams.
2. Distribute and as a group read the Canada Remembers the Battle of the Atlantic handout.
3. Read a question to the teams and give them an opportunity to answer.
4. If the team answers correctly, award them 5 points. If the team answers incorrectly, give the other team the opportunity to answer the question.
5. Continue until all the questions have been answered or time runs out.

THIS PAGE INTENTIONALLY LEFT BLANK

CANADA REMEMBERS THE BATTLE OF THE ATLANTIC



Introduction

The Battle of the Atlantic was the longest continuous battle of the Second World War and one in which Canada played a central role. The battle began on the opening day of the war in September 1939 and ended almost six years later with Germany's surrender in May 1945.

The Battle of the Atlantic

The Battle of the Atlantic was the struggle between the Allied and German forces for control of the Atlantic Ocean. The Allies needed to keep the vital flow of men and supplies going between North America and Europe, where they could be used in the fighting, while the Germans wanted to cut these supply lines. To do this, German submarines, called U-boats, and other warships prowled the Atlantic Ocean sinking Allied transport ships.

The Battle of the Atlantic brought the war to Canada's doorstep, with U-boats torpedoing ships within sight of Canada's East Coast and even in the St. Lawrence River. Canada's Merchant Navy, along with the Royal Canadian Navy (RCN) and the Royal Canadian Air Force (RCAF), played a key role in the Allied efforts. East Coast cities soon found themselves involved in the battle, since Allied convoys (groups of ships that crossed the Atlantic together under the protection of naval escorts) were frequently leaving busy ports like Halifax and Sydney, Nova Scotia, and St. John's, Newfoundland, during the war.

Challenges and Successes

Early in the war, German U-boats took a heavy toll on merchant shipping as the Allies struggled to find effective ways to combat the enemy threat. Between 1939 and 1942, the Germans increased the number of U-boats from 30 to 300 and developed effective hunting techniques like using groups of submarines, called wolfpacks, to attack convoys. Their efforts initially paid off, with 454,000 tonnes of shipping being lost to German U-boats in June 1941 alone. Their successes continued as nearly 400 Allied ships were sunk between January and July 1942, while only seven U-boats were lost. The situation was very serious for the Allies, as merchant ships were being sunk faster than they could be replaced, thereby putting the supply link between North America and Europe at great risk.

Technology played an important role in the Battle of the Atlantic. Aircraft were effective in protecting merchant ships, but the Allied planes used earlier in the war did not have enough range to offer air cover for the convoys all the way across the Atlantic. Indeed, the central area of the ocean beyond aircraft range became known as the "Black Pit" as that was where many of the heaviest convoy losses occurred. However, the introduction of new long-range planes helped reduce the hazards of this dangerous portion of the run.

Both sides kept trying to get the upper hand in technology and tactics during the Battle of the Atlantic. Germany developed torpedoes that were attracted to the noise made by a ship's propellers. Allied scientists responded by inventing a noise-making device that was towed behind a ship to divert the torpedoes. New radar and sonar (ASDIC) technologies helped the Allies find the U-boats and new weapons, like the "Hedgehog" bombs, helped sink the submarines more effectively. The Germans also developed technological advancements like snorkel tubes that allowed U-boats to run their diesel engines while travelling underwater and on-board radar that increased their submarines' capabilities. Eventually, the improved equipment and tactics of the Allies finally

helped turn the tide of the battle in their favour, with the U-boat fleet suffering heavy losses during the later phases of the war.

The growth of Canada's navy was remarkable. At the beginning of the Second World War, the RCN had only six ocean-going ships and 3 500 personnel. By the end of the war, Canada had one of the largest navies in the world with 434 commissioned vessels and 95,000 men and women in uniform. Canada's industry also played an important role in the growth of our military and merchant navies. From 1941 to 1945, Canadian shipyards produced approximately 403 merchant ships, 281 fighting ships, 206 minesweepers, 254 tugs, and 3 302 landing craft.

Sacrifices

Helping the Allies triumph in the Battle of the Atlantic came at a high price. More than 1,600 Merchant Navy personnel from Canada and Newfoundland were killed. Indeed, percentage-wise, their casualty rate was higher than those of any of Canada's fighting services during the Second World War—one out of every seven Merchant Navy sailors who served was killed or wounded.

The RCN and RCAF also paid a high toll in the Battle of the Atlantic. Most of the 2,000 RCN officers and men who died during the war were killed during the Battle of the Atlantic, as were 752 members of the RCAF. There were also civilian casualties. On October 14, 1942, 136 people died when the ferry SS *Caribou* was sunk as it crossed from Nova Scotia to Newfoundland.

Legacy

Allied victory in the Second World War would not have been possible without victory at sea. It would require overcoming great odds, but the courage of the RCN, Merchant Navy and RCAF personnel helped keep the Allied convoys running and the supply lines to Europe open. These brave men and women were some of the more than one million Canadians who served in the cause of peace and freedom during the Second World War.

CANADA REMEMBERS THE BATTLE OF THE ATLANTIC QUESTIONS AND ANSWERS

1. True or False: The Battle of the Atlantic was the longest continuous battle of the Second World War.
True.
2. True or False: The Battle of the Atlantic brought the war to Canada's doorstep; with U-boats torpedoing ships within sight of Canada's East Coast and even in the St. Lawrence River.
True.
3. True or False: Between January and July 1942, more U-boats were sunk than merchant ships.
False.
4. What did Germany develop that were attracted to the noise of a ship's propellers?
Torpedoes.
5. How many members of the Royal Canadian Navy and the Royal Canadian Air Force died during the Battle of the Atlantic?
2000 RCN and 750 RCAF.
6. In what month and year did the Battle of the Atlantic begin?
September 1939
7. What were the German submarines referred to as?
U-boats
8. Which three East Coast cities were busy Allied convoy ports during the Battle of the Atlantic?
Halifax and Sydney (Nova Scotia) and St. John's (Newfoundland).
9. What was the zone in the central area of the Atlantic Ocean where many of the heaviest Allied convoy losses occurred known as?
The Black Pit
10. On October 14, 1942, 136 people died when this passenger ship was sunk as it crossed from Nova Scotia to Newfoundland.
SS Caribou
11. Why was control of the Atlantic Ocean so important during WWII?
It was where the vital flow of men and supplies between America and Europe was happening.
12. Name the three Canadian organizations that played a key role for the Allies in bringing supplies to Europe.
Canada's Merchant Navy,
Royal Canadian Navy (RCN), and
Royal Canadian Air Force (RCAF).
13. How many Merchant Navy personnel from Canada and Newfoundland died during the Battle of the Atlantic?

More than 1,600.

BATTLE OF VIMY RIDGE

OBJECTIVE: The aim of this learning station is to familiarize the cadets with the Battle of Vimy Ridge.

TIME: 30 min

TRAINING LEVEL: 1-2

PRE-ACTIVITY INSTRUCTIONS:

- Assign an instructor to this activity.
- Photocopy the World War 1—The Battle of Vimy Ridge handout, located at Appendix 2, for each cadet.
- Gather the required resources: 2 noisemakers (eg, bell, bicycle horn, kazoo).

ACTIVITY INSTRUCTIONS:



This activity is designed to be presented in a “game show” format. If possible, have a small prize available to the winning team.

1. Divide the cadets into two teams.
2. Distribute and have the cadets read the World War 1—The Battle of Vimy Ridge handout.
3. Read a question to the teams and give them an opportunity to answer.
4. If the team answers correctly, read the additional information and award them 5 points. If the team answers incorrectly, give the other team the opportunity to answer the question.
5. Continue until all the questions have been answered or time runs out.

THIS PAGE INTENTIONALLY LEFT BLANK

WORLD WAR I – THE BATTLE OF VIMY RIDGE QUESTIONS AND ANSWERS

1. The Battle of Vimy Ridge took place during which war?

World War I.

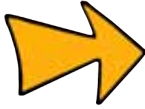

World War I started in July 1914 and ended 11 November 1918.

2. Vimy Ridge is located in which country?

France.



World War I began when Germany invaded France and Belgium.

3. Who were the four divisions of the Canadian Corps attempting to capture Vimy Ridge from?

German Sixth Army.



The German Sixth Army was responsible for defending the Vimy Ridge portion of the Western Front.

4. The Battle of Vimy Ridge was the first time the Canadian Expeditionary Force did this together:

They fought as one force under a Canadian Commander.



Until this point in the war, Canadian divisions had been under British command. For Vimy Ridge all four Canadian Divisions were assembled as one group under Canadian command.

5. Who took command of the Canadian corps in May 1916?

Sir Julian Byng.



Sir Julian Byng was, at this point in the war, a British Lieutenant-General who took command of the Canadian troops in the Vimy Ridge area in June 1916. After the war, in 1921, Byng was appointed as Governor-General of Canada. He and his wife, Lady Byng were also big hockey fans and in 1925 Lady Byng donated a trophy to be awarded for sportsmanship and gentlemanly conduct. The Lady Byng Memorial Trophy is still awarded yearly.

6. Why did Canadian Corps Officers interview French Officers and attend French Army lectures when planning the attack on Vimy Ridge?

To learn what tactics worked, and which ones did not, in an effort to minimize casualties and help in the upcoming assault.

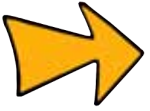

To help in developing a plan for the attack on Vimy Ridge, Canadian Corps Officers attended lectures given by the French Army on the Battle of Verdun. This was because the Battle of Verdun had been one of the few Allied successes in 1916. They also interviewed French officers and compared the discrepancies between the beliefs of the senior officers and the actual experiences of the junior officers in an attempt to get a genuine idea of what had happened.

7. What is the term used for an infantry tactic where one group provides suppressing fire on the enemy while the second group moves forward?

Leapfrogging.



The standard practice in World War I was for all the infantry to progress in a rough line toward the enemy positions. This created a situation where soldiers coming under enemy fire would falter and stop the advance. The plan of attack for Vimy Ridge called for the Canadian infantry to leap frog over one another behind a creeping barrage. This allowed the Canadians to maintain the momentum of the advance during the attack.

8. What is a “creeping barrage”?

A tactic in which artillery fire slowly moves forward to provide cover.



During the creeping barrage, the guns of the artillery fire at a line just ahead of the advancing infantry. The artillery slowly moves their fire forward to provide cover for the infantry. At Vimy the Canadians had been extensively trained in what became known as the “Vimy Glide” where the infantry moved at a 100 metre / 3 minute pace to stay directly behind the artillery. The creeping barrage was a tactic which had only been marginally successful up until Vimy Ridge. General Sir Arthur Currie, believing in the use of overwhelming artillery on a narrow front, helped to perfect the use of the creeping barrage.

9. A new tactic employed by Canadians at Vimy Ridge was to train every soldier in exactly what do, where to go and what the objective was. Why was this tactic effective?

This tactic gave soldiers the knowledge to be able to take command of a platoon if the platoon leader was killed or wounded, and reach their objective even if separated from their leaders.

10. Why did the Canadians dig tunnels in preparation for the attack?

To plant mines and to move Canadian soldiers as close to the German lines as possible before the actual assault.



The Vimy sector had good soil for tunnelling and led to extensive underground warfare. Both sides engaged in the practice of tunnelling under the enemies trenches and exploding mines. In preparation for Vimy, the mining engineers dug 12 subways up to 1.2km long and laid specialized explosives at the end of them which, when exploded, would create trenches across no-mans-land which the infantry could use to safely reach the German lines.

11. Why did Canadians engage in trench raiding prior to the battle?

To harass the enemy and gather intelligence.

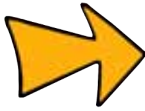

In the period leading up to the Battle of Vimy Ridge, the Canadian Corps engaged in the practice of trench raiding. Trench raiding was small scale attacks on enemy positions usually made at night.

12. On April 2nd, 1917 until the beginning of the offensive on April 9th every gun in the Canadian arsenal bombarded the German lines. Why did the Germans refer to this as the “week of suffering”?

The barrage almost completely destroyed the German trenches and defensive works and kept them at the ready for 18 days. They could not be resupplied.



Phase 1 of the artillery bombardment started on March 20th, 1917 with half of the 983 guns systematically targeting German strong points, trenches and batteries while paying specific attention to clearing barbed wire. The targets and intensity of the barrage was purposely varied to confuse the Germans. On April 2nd, 1917 the artillery shifted to Phase 2 which involved every gun in the Canadian arsenal almost constantly bombarding the enemy positions.

13. What had been achieved by nightfall of the second day of the battle?

The Canadian Corps had captured all but one objective known as the Pimple.



Having captured the three lines of German trenches by the end of the day on April 9th, 1917, the advance commenced the next day with reinforcements from the British. Supported by two sections of tanks and fresh British brigades, by nightfall the Canadian Divisions had captured the entire ridge except the Pimple, which was the highest point of the ridge and was heavily fortified.

14. In 1922, France granted Canada perpetual use of a portion of Vimy Ridge. What did Canada open on this site in 1936?

The Canadian National Vimy Memorial.



The memorial took 11 years to complete and cost \$1.5 million dollars to build. It was unveiled by King Edward VIII and is Canada’s largest overseas memorial.

THIS PAGE INTENTIONALLY LEFT BLANK

WORLD WAR I – THE BATTLE OF VIMY RIDGE

July 1914 – Germany invades France. Vimy Ridge captured in October.

Trench warfare ensues from 1914-1918.

Vimy Ridge is an escarpment which is approximately 7 km long and rises 60 metres above the surrounding plains. The slope on the western (Canadian) side rises gradually and is steeper on the eastern side.

May 1916 – Sir Julian Byng takes command of the Canadian Corps.



General Sir Arthur Currie, Commander, 1st Canadian Division.

In an attempt to break through the German lines, the British launched an offensive in April 1917 near the City of Arras. Vimy Ridge was on the northernmost part of the line and was held by the German Sixth Army.

To prepare for the battle, Canadian Corps Officers interviewed French officers to find out what tactics had worked or had not worked in the previous battles.

Leading up to the battle, Canadians engaged in "trench raiding" to harass the enemy and gather intelligence.



Scale reproduction of the trenches at Vimy Ridge.

The planning for the attack on Vimy Ridge was extensive and included:

- platoons leapfrogging behind a creeping barrage (artillery fire slowly moving forward to provide cover) to maintain the momentum of the advance;
- every soldier being trained in exactly what to do, where to go and what the objective was so they could take command of a platoon if the Platoon Leader was killed;
- using new counter-battery techniques such as flash-spotting and sound-ranging to locate enemy guns; and
- digging tunnels under German lines to plant mines and protect soldiers.

On April 2nd, 1917 until the beginning of the offensive on April 9th every gun in the Canadian arsenal bombarded the German lines. The Germans referred to this period as the “week of suffering” because their trenches and defensive works were almost completely destroyed, it kept them from being resupplied and they were kept at the ready through the whole period.

The battle started at 0530hrs on April 9th, 1917 and by 0730 hrs three of four Canadian Divisions had reached their second objective.



Canadian troops following a tank at Vimy Ridge.

3598 Canadians were killed and 7004 wounded. Four Canadians were awarded the Victoria Cross.

By the end of April 9th, 1917 the Canadian Corps had captured three lines of German trenches. The advance continued the next day and by nightfall they had captured all but one objective known as the Pimple.

The site of the Canadian National Vimy Memorial was granted to Canada by France for perpetual use in 1922. The 100-hectare park is partially closed to the public because it is riddled with tunnels, trenches, craters and unexploded munitions.

BATTLE OF BRITAIN

OBJECTIVE: The aim of this learning station is to familiarize cadets with the Battle of Britain.

TIME: 30 min

TRAINING LEVEL: 3–4

PRE-ACTIVITY INSTRUCTIONS:

1. Assign an instructor to this activity.
2. Photocopy the Battle of Britain handout, located at Appendix 1, for each cadet.
3. Gather the required resources: 2 noisemakers (eg, bell, bicycle horn, kazoo).

ACTIVITY INSTRUCTIONS:



This activity is designed to be presented in a “game show” format. If possible, have a small prize available to the winning team.

1. Distribute and have the cadets read the Battle of Britain handout. As they read, have the cadets mark an asterix (*) next to the information they feel is most important and a question mark next to the information they would like to learn more about.
2. Divide the cadets into two teams.
3. Distribute and have the cadets read the Battle of Britain handout.
4. Read a question to the teams and give them an opportunity to answer.
5. If the team answers correctly, award them 5 points. If the team answers incorrectly, give the other team the opportunity to answer the question.
6. Continue until all the questions have been answered or time runs out.

THIS PAGE INTENTIONALLY LEFT BLANK

The Battle of Britain was an intense air battle between the Germans and the British over Great Britain's airspace from July 1940 to May 1941, with the heaviest fighting from July to October 1940.

It is one of the most famous battles of World War Two.

It was the first time the Germans had faced defeat in World War II and the first battle in history to be fought exclusively in the air.

Germany expected to quickly conquer Great Britain by first gaining domination over airspace and then later sending in ground troops across the English Channel (Operation Sealion).

At first they targeted airfields, but soon switched to bombing general strategic targets, hoping to crush British morale.

By far the largest number of defenders were British, but fighter pilots of many other nations flew with them, including Canadians.

On July 11, the second day of the battle, the Canadians suffered their first fighter casualty. Pilot Officer D. A. Hewitt of Saint John, N.B., hurled his 501 Squadron Hurricane at a Dornier bomber and was hit himself. Gushing smoke, his plane plunged into the sea.

The RAF had the edge over the Luftwaffe with its new faster fighters the Spitfire and Hurricane. The design and speed meant that they could out manoeuvre the German fighters.

THE BATTLE OF BRITAIN



During the summer of 1940, a few hundred fighter pilots stood in the way of Hitler's massive air attack on England. One hundred Canadians were among them.

"It is certainly an awful sight to behold those ugly black bombers in rank after rank," remembered Canadian pilot Ernest McNab. "Your mouth dries up like cotton wool. You lose all sense of space and time. We fought far above the clouds in a world of our own - a world of freezing cold, of limitless space traced with white plumed trails of wheeling aircraft as they fought. It was like skywriting gone mad."

British Prime Minister Winston Churchill said "The Battle of France is over. I expect the Battle of Britain is about to begin. The whole fury and might of the enemy must very soon be turned on us. Let us therefore be prepared to do our duty so that, if the British Empire lasts for a thousand years, men will say, 'This was their finest hour'." (18 June 1940)

Radar held the key to Britain's victory. German aircraft were detected and tracked by stations near the coast, then plotted in the Fighter Command operators rooms as Hurricanes and Spitfires climbed to intercept.

More than 400 Canadian aircrew and ground crew were involved in the Battle during that fateful summer and autumn in 1940, and of the more than 100 Canadian pilots who participated, 23 died while another 30 perished later in the war.

By the end of the war, 232,632 men and 17,030 women had served in the RCAF, and 17,101 lost their lives.

Other countries participating in the battle were:

Australia
New Zealand
South Africa
Southern Rhodesia
Ireland
United States of America
Poland
Czech Republic
Belgium
France
Israel

On September 15, 1940 Germany launched an all-out aerial attack. Air raid sirens wailed over London. Waves of incoming German aircraft left thousands dead and London in ruins. British, Canadian and other Allied pilots scrambled to their Hurricanes and Spitfires.

"It was a terrific spectacle," McNab recalled. "There were more than a thousand aircraft in the sky just south of London. So many that there was as much danger of colliding with another fellow as there was of being shot down."

British Prime Minister Winston Churchill was in the command bunker deep below the streets of London. "I asked Air Vice Marshall what other reserves have we," he wrote. 'There are none,' he replied. The odds were great; our margins small; the stakes infinite."

But by the end of the day, Germany had lost over 60 aircraft and failed to smash the Allied air defenses. Although British cities would be bombed nightly for the next six months, the threat of invasion was over, the Allies had won the Battle of Britain.

THE BATTLE OF BRITAIN QUESTIONS AND ANSWERS

1. Who was the first Canadian to die during the Battle of Britain?
PO D. A. Hewitt
2. What gave the RAF an edge over the Luftwaffe?
The faster Spitfires and Hurricanes.
3. True or False: The Battle of Britain was the first battle in history to be fought exclusively in the air?
True.
4. True or False: The Battle of Britain was the first time Germany faced defeat in World War II?
True.
5. Should all the credit go to British fighter pilots for winning the Battle of Britain?
No. More than 11 countries participated.
6. How important was technology in helping the RAF win the Battle of Britain?
Very important because of the planes and RADAR.
7. How many Canadian groundcrew and aircrew were involved in the Battle of Britain?
More than 400.
8. How many Canadians died during the battle?
23.

THIS PAGE INTENTIONALLY LEFT BLANK

BRITISH COMMONWEALTH AIR TRAINING PLAN (BCATP)

OBJECTIVE: This activity is designed to familiarize the cadets with the British Commonwealth Air Training Plan.

TIME: 30 min

TRAINING LEVEL: 1–4

PRE-ACTIVITY INSTRUCTIONS:

1. Assign an instructor to this activity.
2. Research local airports and see if any in the area can trace their history back to the plan. If so, share the information with the cadets.
3. Photocopy the Canada Remembers the British Commonwealth Air Training Plan handout, located at Appendix 1, for each cadet.
4. Gather the required resources: 2 noisemakers (eg, bell, bicycle horn, kazoo).

ACTIVITY INSTRUCTIONS:



This activity is designed to be presented in a “game show” format. If possible, have a small prize available to the winning team.

1. Distribute and have the cadets read the Canada Remembers the British Commonwealth Air Training Plan handout. As they read, have the cadets mark an asterisk (*) next to the information they feel is most important and a question mark next to the information they would like to learn more about.
2. Divide the cadets into two teams.
3. Read a question to the teams and give them an opportunity to answer.
4. If the team answers correctly, award them 5 points. If the team answers incorrectly, give the other team the opportunity to answer the question.
5. Continue until all the questions have been answered or time runs out.

THIS PAGE INTENTIONALLY LEFT BLANK



Photo: DND/RCAF PA 3730

INTRODUCTION

When the Second World War broke out in 1939, Canada was an ocean away from the scene of the fighting in Europe. But geographical distance did not mean that Canada would not play an important role in the struggle to restore peace.

One of the first and most important contributions our country would make to the war effort would be the British Commonwealth Air Training Plan (BCATP). Under a deal signed in 1939, Canada agreed to provide facilities and training for airmen from every part of the Commonwealth. Canada was ideally suited for this program because our country was far from most of the active fighting and had lots of wide-open spaces and good flying conditions.

“THE AERODROME OF DEMOCRACY”

The BCATP was an enormous undertaking. In 1939, the Royal Canadian Air Force (RCAF) had only 4,000 personnel, less than a dozen airports of its own and training facilities for only 400 ground crew per year. Now the RCAF was expected to train thousands. It had to recruit instructors, build air bases, acquire aircraft and develop training schools for different specialities. By war's end, there were 151 training schools and every province had BCATP installations. Canada was, in U.S. President Roosevelt's words, “the aerodrome of democracy”.

- During the time of its operation, the BCATP employed 3,540 aircraft, 33,000 air force personnel, and 6,000 civilian employees.
- The government built 7,000 hangars, barracks and drill halls for the air bases and training schools.

- Most training schools had three runways, each 100 feet wide and 2,500 feet long. Enough concrete was used in creating the runways for all the BCATP air bases to build a 20-foot wide highway from Ottawa to Vancouver.
- Under the original agreement to establish the BCATP, Britain was to pay \$218 million, Canada \$313 million, Australia \$97 million and New Zealand \$21 million. Costs, however, escalated far beyond the 1939 estimates. In the end, Canada paid \$1.6 billion of the total cost of \$2.2 billion. In terms of today's money, that meant that each taxpayer living in Canada ended up contributing more than \$3,000 just to pay for the BCATP.

RIGOROUS TRAINING

Training in the BCATP was challenging and rigorous. Pilots, wireless operators, air gunners, air observers and flight engineers went through months of training at specialized schools.

- The pilot training was the longest and most difficult. From Initial Training School, they went to Elementary Flying Training School, where they got their first chance to fly, followed by Service Flying Training Schools where they were separated into fighter and bomber pilots. From there they went into Advanced Flying and Operational Training Units before going overseas.
- Of the Canadians trained in the BCATP, 25,747 would become pilots: 12,855 navigators; 6,659 air bombers; 12,744 wireless operators; 12,917 air gunners, and 1,913 flight engineers.
- The risks and sacrifices of those serving their country during the Second World War were not limited to

those who were engaged in active fighting. Training could be hazardous, as demonstrated by the 856 trainees who died in crashes during BCATP's five years of operation. As high as these figures may seem, it was to the credit of the plan that, by 1944, only one fatal accident was being recorded for each 22,388 hours of flying time.

EVERYONE PITCHES IN

Civilians played an important role in the BCATP, providing instructors for training schools and community support for airmen who were far away from home.

- Bush and commercial pilots joined as instructors, working side-by-side with military personnel.
- In the beginning, the government entrusted Canadian flying clubs with the organization and operation of the Elementary Flying Training Schools. Many of their members had served in the First World War and provided an immediate source of skilled manpower.
- Civilian instructors in Elementary Flying Training Schools emphasized safety, working under the maxim "There are old pilots and bold pilots; there are no old, bold pilots."
- Some flying clubs paid for the entire cost of a training school using private funds or community donations. In Vancouver, citizens paid for 14 training aircraft out of their own pockets.
- Women's organization ran canteens, sports organizations supplied athletic equipment and service clubs provided items like pianos for barracks halls.

- Many people invited trainees into their own homes for meals as a patriotic gesture and as a part of their personal involvement in the war effort.

AN OUTSTANDING SUCCESS

The BCATP was an outstanding success. By the end of the war, it had graduated 131,533 pilots, observers, flight engineers and other aircrew for the air forces of Canada, Britain, Australia and New Zealand. While over half the BCATP graduates came from the North American continent, the plan trained personnel from all over the world including about 2,000 French, 900 Czechoslovakians, 680 Norwegians, 450 Poles and about the same number of Belgians and Dutch.

- 72,835 graduates joined the Royal Canadian Air Force
- 42,110 graduates joined the Royal Air Force
- 9,606 joined the Royal Australian Air Force
- 7,002 joined the Royal New Zealand Air Force

THE LEGACY

Knowing about our country's military history helps us to understand the Canada in which we live today and how we can build our future together. The British Commonwealth Air Training Plan helped create a legacy in Canada that continues to this day, demonstrating that our future is indeed built on our past. To learn more about Canada's role in the Second World War, please visit the Veterans Affairs Canada Web site at: www.vac-acc.gc.ca or call 1-877-604-8469 to obtain information on available publications.

Photo: Canadian Forces PL 907



CANADA REMEMBERS THE BRITISH COMMONWEALTH AIR TRAINING PLAN (BCATP) QUESTIONS AND ANSWERS

1. Why was Canada ideally suited for the BCATP?
It was far from most of the fighting and had lots of wide-open spaces and good flying conditions.
2. How much was the total cost of the plan to Canadians?
Total cost was 2.2 billion dollars.
3. What type of training was done at the specialized schools?
Pilot, wireless operator, air gunner, air observers and flight engineer.
4. How many pilots, observers, flight engineers and other aircrew graduated through the BCATP?
131,533.
5. How do you think communities benefitted from the BCATP?
Employment for community members, economic benefits, facilities that were built for those attending the schools could be used by the community members following the war.
6. What was the lasting effect of the BCATP?
New airports or upgrades to existing airports and communities expanding around the new airports.
7. In your own words, why do you think it is important to know about Canada's military history?

THIS PAGE INTENTIONALLY LEFT BLANK

ROLES OF THE CANADIAN ARMED FORCES (CAF)

OBJECTIVE: The aim of this activity is to familiarize the cadets with the roles of the CAF.

TIME: 30 min

TRAINING LEVELS: 1–4

PRE-ACTIVITY INSTRUCTIONS:

- Assign an instructor to this activity.
- Photocopy the Fact Sheets, located at Appendices 1–3, for each cadet.
- Gather the required resources:
 - Paper, and
 - Markers / pencil crayons.



For the purpose of this activity, there will be two sets of groups formed (as described in the activity instructions):

- expert groups, and
- jigsaw groups.

Refer to Figure 1 for a visual representation of the format for these groups using five cadets per jigsaw group.

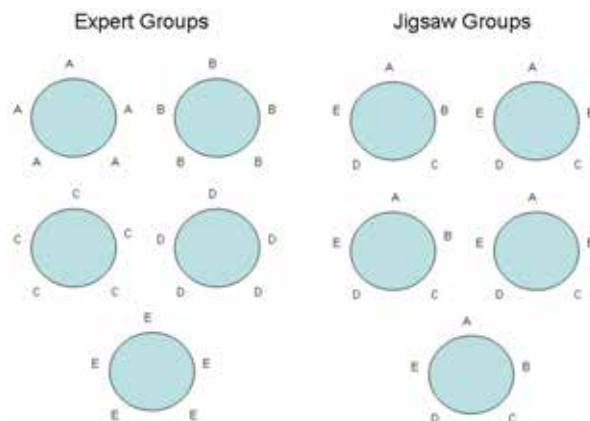

Figure 1 Format of Jigsaw Activity Groups

ACTIVITY INSTRUCTIONS:

1. Explain the following to the cadets:
 - (a) They will be participating in a jigsaw activity about roles of the CAF.
 - (b) A jigsaw structure allows each cadet, as a member of a team, to become an "expert" in their part of the assignment. They will interpret the information they receive, both on their own and as a contributing member of a team, and present the information as a response.
 - (c) They will be divided into three expert teams, and each team will be given a Fact Sheet to review. Cadets will become experts on their Fact Sheet.

- (d) After reviewing their Fact Sheet and preparing a 3–5-minute presentation, cadets will then form jigsaw teams by regrouping with the cadets from the other expert teams so that there is one person from each expert team present in the new jigsaw team.
 - (e) They will then take turns presenting their Fact Sheets.
2. Divide the cadets into three equal expert teams (or six equal jigsaw teams if there are many cadets).
 3. Distribute paper, markers / pencil crayons, and a different Fact Sheet to each expert team.
 4. Have the cadets review and discuss the fact sheets, and prepare a 3–5-minute presentation highlighting 2–3 key points from their fact sheet. Encourage the cadets to use the markers / pencil crayons and paper to create visual aids to support their presentation.
 5. Have the cadets form jigsaw teams by placing one member from each expert team into a new group. There should be three members in each jigsaw team. If it is necessary to have two cadets with the same information in the same jigsaw team, they shall co-present the information.
 6. Have each cadet give their 3–5-minute presentation to their jigsaw team.
 7. Circulate among the groups and assist the cadets as necessary, offering suggestions and advice for improvement.

FACT SHEET – DEFENDING CANADA

The CAF ensures the security of Canadians and helps to exercise Canada's sovereignty.

They work closely with federal government partners to ensure the constant monitoring of Canada's territory and air and maritime approaches, including in the Arctic. The presence of the CAF in the Arctic helps to establish Canada's sovereignty in that region.

They need to identify threats, and to possess the capacity to address them quickly and effectively.

Delivering excellence at home requires the CAF to:

- **Provide surveillance of Canadian territory and air and maritime approaches;**
- **Maintain search and rescue response capabilities that are able to reach those in distress anywhere in Canada 24 hours a day, 7 days a week; and**
- **Assist civil authorities in responding to a wide range of threats - from natural disasters to terrorist attacks.**

The CAF assists other government departments with:

- **over-fishing,**
- **organized crime,**
- **drug- and people-smuggling,**
- **environmental degradation, and**
- **security for international events, such as the 2010 Vancouver Olympic Games.**

THIS PAGE INTENTIONALLY LEFT BLANK

FACT SHEET – DEFENDING NORTH AMERICA

A Strong and Reliable Partner

The CAF works with their US counterparts as a partner in the North American Aerospace Defence Command (NORAD). It was created in 1958, and its primary mission is defending North American aerospace and maritime approaches.

The two forces are dedicated to provide assistance to civilian emergency response agencies in the event of a crisis.

The CAF and US military operate some of the same equipment, participate in joint training exercises and exchange personnel.

Some examples of CAF assisting with the defence of North America include:

OPERATION NOBLE EAGLE. Operation Noble Eagle began with the mobilization of thousands of National Guard and reserve personnel to perform security missions on military installations, airports and other potential targets such as bridges, power plants, and port facilities. The Canadian NORAD Region (CANR) flew Operation Noble Eagle (ONE) air defence protection missions in the Windsor, Ontario / Detroit, Michigan area on 5 February 2006, in support of Super Bowl XL at Ford Field.

OPERATION UNISON. In Operation Unison, the federal government deployed a task force comprising three warships—HMCS ATHABASKAN, HMCS TORONTO and HMCS VILLE DE QUÉBEC—along with the Coast Guard vessel CCGS SIR WILLIAM ALEXANDER, three Sea King helicopters and one BO-105 helicopter after Hurricane Katrina in the United States. The CAF also provided several Griffon helicopters and crews to the New England States at the request of the United States Coast Guard.

THIS PAGE INTENTIONALLY LEFT BLANK

FACT SHEET – CONTRIBUTING TO INTERNATIONAL PEACE AND SECURITY

Providing international leadership is vital for Canada to be a credible player on the world stage. This requires the CAF to have the necessary capabilities to make a meaningful contribution in:

- **international operations,**
- **humanitarian assistance,**
- **stabilization operations, or**
- **combat.**

Operations will often be conducted in partnership with the United Nations (UN) and the North Atlantic Treaty Organization (NATO). In addition, the CAF will participate, where circumstances dictate, in missions with other members of the international community.

Canada must be prepared to act and provide appropriate resources in support of national interests and international objectives.

Projecting Leadership Abroad: Lessons Learned from the Afghanistan Mission

The CAF have learned many lessons from their mission in Afghanistan. The mission has reinforced the need to:

- **maintain combat-capable units;**
- **provide deployed personnel with the right equipment so they can take part, on their own or with allies, in operations - from countering improvised explosive devices, to contributing to reconstruction efforts; and**
- **work closely and develop a strong working relationship with partners.**

THIS PAGE INTENTIONALLY LEFT BLANK

ROLES OF THE CANADIAN ARMED FORCES (CAF) - DEFENDING CANADA

OBJECTIVE: The aim of this activity is to familiarize the cadets with one of the roles of the CAF—defending Canada.

TIME: 30 min

TRAINING LEVELS: 1–4

PRE-ACTIVITY INSTRUCTIONS:

- Assign an instructor to this activity.
- Display Fact Sheet—Defending Canada, located at Annex K, Appendix 1, in a prominent location at the learning station. The fact sheet may be printed on a larger piece of paper to ensure that it can be read by all the cadets.

ACTIVITY INSTRUCTIONS:

1. Have the cadets read and discuss the fact sheet.
2. Have the cadets develop a skit that demonstrates the CAF's role in defending Canada. The skit should include several aspects of that role. An example of a skit is a news interview with CAF members assisting civilians in a natural disaster.
3. Circulate and assist the cadets as necessary, offering suggestions and advice for improvement.
4. Have the cadets perform their skit.
5. Have the cadets think about one interesting fact they learned about the CAF's role in defending Canada and share their thought with their team.



The cadets may want to perform their skit for other cadets or during the Annual Ceremonial Review.

THIS PAGE INTENTIONALLY LEFT BLANK

ROLES OF THE CANADIAN ARMED FORCES (CAF) - DEFENDING NORTH AMERICA

OBJECTIVE: The aim of this activity is to familiarize the cadets with one of the roles of the CAF—defending North America.

TIME: 15 min

TRAINING LEVELS: 1–4

PRE-ACTIVITY INSTRUCTIONS:

- This learning station may be assigned an instructor or be self-directed by the cadets.
- Photocopy the Fact Sheet—Defending North America, located at Annex K, Appendix 2, and the Defending North America worksheet, located at Appendix 1 to this annex, for each cadet.
- Review the Defending North America worksheet answer key, located at Appendix 2 to this annex.

ACTIVITY INSTRUCTIONS:

1. Have the cadets read the Fact Sheet—Defending North America.
2. Distribute the Defending North America worksheet to each cadet.
3. Divide the cadets into pairs.
4. Have the first cadet ask the second cadet a question on the worksheet. The second cadet will answer the question. The first cadet will make corrections, as required, and praise when complete. Both cadets will copy the answer onto their worksheet.
5. Have the second cadet ask the first cadet a question on the worksheet. The first cadet will answer the question. The second cadet will make corrections, as required, and praise when complete. Both cadets will copy the answer onto their worksheet.
6. Repeat Steps 4 and 5 until the worksheet is complete.

THIS PAGE INTENTIONALLY LEFT BLANK

THIS PAGE INTENTIONALLY LEFT BLANK

DEFENDING NORTH AMERICA – A STRONG AND RELIABLE PARTNER

Worksheet

ANSWER KEY

- 1. Who does the CAF work with in defending North America?**

The Armed Forces of the United States of America.

- 2. What is NORAD and what is it responsible for?**

North American Aerospace Defense Command (NORAD) is responsible for defending North American airspace and maritime approaches.

- 3. What was the name of the operation in support of Super Bowl XL?**

Operation Noble Eagle.

- 4. What was the name of the operation that deployed after Hurricane Katrina?**

Operation Unison.

- 5. How are the CAF and the US forces able to work together?**

They use some of the same equipment, participate in joint training exercises, and exchange personnel.

THIS PAGE INTENTIONALLY LEFT BLANK

ROLES OF THE CANADIAN ARMED FORCES (CAF) - CONTRIBUTING TO INTERNATIONAL PEACE AND SECURITY

OBJECTIVE: The aim of this activity is to familiarize the cadets with one of the roles of the CAF—defending North America.

TIME: 15 min

TRAINING LEVELS: 1–4

PRE-ACTIVITY INSTRUCTIONS:

- This learning station may be assigned an instructor or be self-directed by the cadets.
- Gather the required resources:
 - Fact Sheet—Contributing to International Peace and Security located at Annex K, Appendix 3,
 - Contributing to International Peace and Security Instruction Sheet located at Appendix 1 to this annex,
 - Blank paper, and
 - Coloured pencils / markers.
- Display the Fact Sheet—Contributing to International Peace and Security, located at Annex K, Appendix 3, in a prominent location at the learning station. The fact sheet may be printed on a larger piece of paper to ensure that it can be read by all cadets.

ACTIVITY INSTRUCTIONS:

Have the cadets read and follow the Contributing to International Peace and Security Instruction Sheet.

THIS PAGE INTENTIONALLY LEFT BLANK

CONTRIBUTING TO INTERNATIONAL PEACE AND SECURITY INSTRUCTION SHEET

1. Review the Fact Sheet—Contributing to International Peace and Security.
2. Create an image that captures key points from the fact sheet. The image should be a visual representation of the CAF's role in contributing to international peace and security.
3. As a team, post your images as a gallery for other cadets to review.



THIS PAGE INTENTIONALLY LEFT BLANK

CURRENT CANADIAN ARMED FORCES (CAF)

OBJECTIVE: The aim of this learning station is to familiarize the cadets with the CAF's six core missions.

TIME: 60 min

TRAINING LEVELS: 1–4

PRE-ACTIVITY INSTRUCTIONS:

- Assign an instructor to this activity.
- Photocopy the Fact Sheets, located at Appendices 1–4, for each cadet.
- Gather the required resources:
 - Paper, and
 - Markers / pencil crayons.



For the purpose of this activity, there will be two sets of groups formed (as described in the activity instructions):

- expert groups, and
- jigsaw groups.

Refer to Figure 1 for a visual representation of the format for these groups when using five cadets per jigsaw group.

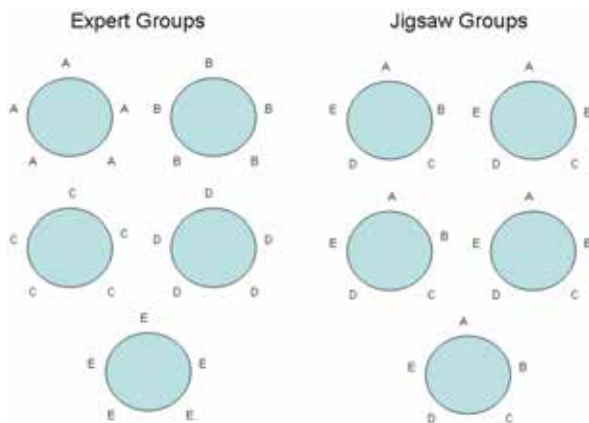

Figure 1 Format of Jigsaw Activity Groups

ACTIVITY INSTRUCTIONS:

1. Explain the following to the cadets:
 - (a) They will be participating in a jigsaw activity about the six core missions of the CAF. The missions are:
 - (1) defend Canada's Arctic Territories and protect Canadian airspace,
 - (2) support international events held in Canada,
 - (3) respond to a major terrorist attack,

- (4) support civilian authorities,
 - (5) conduct major international operations, and
 - (6) provide rapid international deployment.
- (b) A jigsaw structure allows each cadet, as a member of a team, to become an "expert" in their part of the assignment. They will interpret the information they receive, both on their own and as a contributing member of a team, and present the information as a response.
 - (c) Although there are six missions, some of been combined so the cadets will be divided into four expert teams, and each team will be given a fact sheet to review. Cadets will become experts on their Fact Sheet.
 - (d) After reviewing their Fact Sheet and preparing a 3–5 minute presentation, cadets will then form jigsaw teams by regrouping with the cadets from the other expert teams so that there is one person from each expert team present in the new jigsaw team.
 - (e) They will then take turns presenting their Fact Sheets.
2. Divide the cadets into four equal expert teams.
 3. Distribute paper, markers / pencil crayons, and a different Fact Sheet to each expert team.
 4. Have the cadets review and discuss the fact sheets, and prepare a 3–5 minute presentation highlighting 2–3 key points from their fact sheet. Encourage the cadets to use the markers / pencil crayons and paper to create visual aids to support their presentation.
 5. Have the cadets form jigsaw teams by placing one member from each expert team into a new group. There should be four members in each group. If it is necessary to have two cadets with the same information in the same jigsaw team, they shall co-present the information.
 6. Have each cadet give their 3–5 minute presentation to their jigsaw team.
 7. Circulate among the groups and assist the cadets as necessary, offering suggestions and advice for improvement.

DEFEND CANADA'S ARCTIC TERRITORIES AND PROTECT CANADIAN AIRSPACE



Canadian Forces Station (CFS) Alert is the most northerly, permanently inhabited location in the world, located only 817 kilometres from the geographic North Pole.

Canada is an Arctic nation with 40% of our landmass in the territories, 162,000 kilometres of Arctic coastline and 25% of the global Arctic. The Government is firmly exercising our sovereignty over our Arctic lands and waters – sovereignty that is long-standing, well-established and based on historic title, international law and the presence of Inuit and other Aboriginal peoples for thousands of years.

Conducted since 2007, Operation NANOOK is a joint Royal Canadian Navy, Canadian Army, Royal Canadian Air Force and Special Forces operation, which works with other federal departments and provincial, territorial, regional and international partners, in order to provide a visible presence in the Arctic and demonstrate Canada's ability to respond to emergency situations in the region.



Joint Task Force North (JTFN) is one of six regional joint task forces located across Canada to conduct continental operations by the CAF. They conduct three major sovereignty operations: *NANOOK*, *NUNAKPUT* and *NUNALIVUT*. These operations, which combine patrols with large-scale security exercises, are conducted as opportunities for the CAF to work closely with municipal, territorial and federal-level mission partners across the Arctic.

North American Aerospace Defense Command (NORAD)



NORAD is a Canada and United States joint organization. It is in charge of the aerospace over North America. Most children in North America have grown up with NORAD since it is this organization that tracks Santa's progress around the world.



NORAD Missions

In close collaboration with homeland defense, security, and law enforcement partners, prevent air attacks against North America, safeguard the sovereign airspaces of the United States and Canada by responding to unknown, unwanted, and unauthorized air activity approaching and operating within these airspaces, and provide aerospace and maritime warning for North America.

THIS PAGE INTENTIONALLY LEFT BLANK

SUPPORT INTERNATIONAL EVENTS HELD IN CANADA / RESPOND TO A MAJOR TERRORIST ATTACK



The RCMP established the V2010 ISU in 2003, uniting law enforcement and the CAF. They were responsible for planning and conducting security operations in support of the 2010 Olympic and Paralympic Winter Games. This included but not limited to: venue security; marine & aviation security; transportation & traffic incident management; physical security; accreditation screening and verification and protective policing.

4500 CAF personnel assisted at the Vancouver Olympics. It was called *Op Podium*.



In 2010, the CAF assisted the RCMP and their law enforcement partners to ensure the safety and security of G-8 and G-20 summit participants and all Canadians. It was one of the largest security events ever held in Canada. CAF personnel were engaged in patrolling, observing and executing security functions in and around the Lester B. Pearson International Airport and the Huntsville area. Canada's Air Force flew surveillance missions, provide early warning detection and air transport in conjunction with their customary NORAD duties. The Royal Canadian Navy provided port security and dive teams while the Canadian Army maintained surveillance, and patrolled and observation posts at the airport and in the Huntsville area.



Operation APOLLO was Canada's military contribution to the international campaign against terrorism from October 2001 to October 2003.

Combined Maritime Forces (CMF) was formed in February 2002 and is responsible for coordinating and leading naval participation in the international campaign against terrorism. In 2008, its mandate expanded to include counter-piracy in response to the rising incidence of attacks on merchant shipping.

CMF has three operational flotillas:

- Canadian Task Force (CTF) -150, responsible for maritime security and counter-terrorism;
- CTF-151, responsible for counter-piracy; and
- CTF-152, responsible for security and cooperation in the Persian Gulf.

A task force is a temporary grouping of units under one commander, formed for the purpose of carrying out a specific operation or mission.

Canada has a Special Operations Forces that send troops anywhere in the world quickly.

THIS PAGE INTENTIONALLY LEFT BLANK

SUPPORT CIVILIAN AUTHORITIES



CAF members help when fires, floods and storms threaten Canadians at home.

Op LOTUS(E) 1-11 was the CAF response to the floods in Montérégie region in Quebec. Severe flooding and heavy rains forced about 1,800 people from their homes. Over 650 CAF personnel were deployed to the region.

Previous flood operations that the CAF helped were:

- 1996 – Saguenay
- 1997 – Red River flood in Manitoba
- 2008 – James Bay, ON (1001 people evacuated)
- 2008 – Saint John River valley flood

In June 2013, CAF personnel and aircraft were deployed to facilities in Southern Alberta. RCAF aircraft and crews deployed to airfields throughout the province and assisted civilian authorities in search and rescue and evacuation efforts, including the rescuing of 31 people during the initial evacuation



After a 27-cm snowfall more than a metre of snow had been dumped on the city. That prompted Toronto officials to call for military assistance in clearing roads, to the amusement of Canadians across the country.

Through these and other operations, the CAF offer their unique skills and capabilities to aid Canada and its citizens in times of crisis.

The geographic area of the ice storm in 1997 stretched across Ontario, Quebec, New Brunswick and Nova Scotia.

Operation LAMA is the code name for the CAF support to civil authorities for hurricane recovery efforts anywhere in Canada. Under *Op LAMA*, the CAF may provide support to all levels of government – federal, provincial and municipal.

Operation PALACI is the CAF assistance to Parks Canada in preventing large avalanches through Rogers Pass, protecting travellers, and clearing the Trans-Canada Highway 1 and CP rail links between British Columbia and the rest of Canada.

THIS PAGE INTENTIONALLY LEFT BLANK

CONDUCT MAJOR INTERNATIONAL OPERATIONS / PROVIDE RAPID INTERNATIONAL DEPLOYMENT



When a Canadian task force deploys beyond Canada's borders and territorial waters, it is usually integrated into a multinational mission led by the North Atlantic Treaty Organization (NATO) or the United Nations (U.N.).

The combat role in Afghanistan ended in 2011 and now *OP ATTENTION* is Canada's participation in the NATO Training Mission-Afghanistan (NTM-A), which delivers training and professional development support to the national security forces of Afghanistan: the Afghan National Army (ANA), the Afghan Air Force (AAF), and the Afghan National Police (ANP).



Operation ARTEMIS is the ongoing CAF participation in maritime security and counter-terrorism operations in the Arabian Sea region.



Operations typically fit into one or more of the following categories:

- Combat operations (eg, *OP APPOLLO*)
- Regional security operations (**eg**, *OP ARTEMIS*)
- Peace-support **and** stabilization operations (*OP JADE*)
- Training and advisory operations (*OP ATTENTION*)
- Humanitarian operations (*OP HESTIA*)
- Non-combatant evacuation operations (*OP MOBILE*)

Operation HESTIA was the Canadian Armed Forces participation in humanitarian operations conducted in response to the catastrophic earthquake that struck Port-au-Prince, Haiti, on 12 January 2010.

Operation JADE is Canada's contribution to the United Nations Truce Supervision Organization (UNTSO) in the Middle East. The organization contains military observers who are attached to the peacekeeping forces in an area. This includes the Golan Heights, Lebanon, and Sinai

Operation MOBILE was the CAF participation in the international response to the uprising in Libya against the regime of President Moammar Gadhafi.

THIS PAGE INTENTIONALLY LEFT BLANK

CURRENT CANADIAN ARMED FORCES (CAF)

OBJECTIVE: The aim of this activity is to familiarize the cadets with the CAF's six core missions.

TIME: 60 min

TRAINING LEVELS: 3–4

PRE-ACTIVITY INSTRUCTIONS:

- This learning station requires an instructor.
- Photocopy the Fact Sheets, located at Annex O, Appendices 1–4.
- Gather the required resources:
 - CAF Video Storyboard template located at Appendix 1,
 - Pens / pencils,
 - Markers, and
 - Video recording devices, if available.

ACTIVITY INSTRUCTIONS:

1. Explain the following to the cadets:
 - (a) They will be divided into four groups and given a Fact Sheet describing one of the core missions of the CAF. If there are not enough cadets for four groups each group can be assigned two Fact Sheets or the number of core mission Fact Sheets can be reduced.
 - (b) After reviewing their fact sheet each group they will develop a 30 second commercial promoting one of the CAF core missions and include as many key points from their fact sheet as possible.
 - (c) They will be expected to share their commercial as a live performance or electronically with the other cadets.
2. Arrange the cadets into groups and distribute one fact sheet, the CAF video template and pencils to each group.
3. Allow 5 minutes for the groups to review their fact sheet and become familiar with the information.
4. Give the teams 20 min to brainstorm their own concept for a 30 second commercial and create a basic script / stick figure storyboard using the template provided.
5. If resources allow, have the teams record their videos in addition to creating a storyboard. A variety of devices can be used, such as cell phones, digital cameras, or video cameras.
6. Circulate among the groups and assist the cadets as necessary, offering suggestions and advice for improvement.
7. Give each team 2–3 min to explain their concept and present their storyboard / video to the rest of the teams.
8. The corps / squadron Commanding Officer may authorize the videos to be uploaded to corps / squadron websites / Youtube channels or shown at Annual Ceremonial Reviews, Mess Dinners, etc.

THIS PAGE INTENTIONALLY LEFT BLANK

CANADIAN ARMED FORCES VIDEO STORYBOARD TEMPLATE

Name of Project: _____

Group Members: _____













THIS PAGE INTENTIONALLY LEFT BLANK

CURRENT CANADIAN ARMED FORCES (CAF)

OBJECTIVE: The aim of this learning station is to familiarize the cadets with the CAF's Disaster Assistance Response Team (DART) and Deployed Technical Assistance Laboratory (DTAL).

TIME: 30 min

TRAINING LEVELS: 1–4

PRE-ACTIVITY INSTRUCTIONS:

- Assign an instructor to this activity.
- Photocopy the Providing Assistance Anywhere in the World handout, located at Appendix 1, for each cadet.
- Photocopy the Questions sheet, located at Appendix 2, for each group.
- Photocopy the answer sheet, located at Appendix 3.
- Preview and download the DART video.

ACTIVITY INSTRUCTIONS:

1. Explain the following to the cadets:
 - (a) In groups, you will have to answer questions either on DART or DTAL, special units of the CAF that respond to emergencies around the world.
 - (b) After answering the questions, you will have to identify 5 facts about your special unit.
 - (c) Each group will share their facts with the other group.
2. Divide the cadets into two groups. One group will learn about DART and the other about DTAL.
3. Distribute a Providing Assistance Anywhere in the World handout and question sheet to each group.
4. Have the groups answer their questions.
5. Circulate among the groups and assist the cadets as necessary. Use the answer sheet to verify that the cadets have answered their questions correctly.
6. Have each group share five facts about their special unit to the other group.
7. Show the cadets the DART video.

THIS PAGE INTENTIONALLY LEFT BLANK

PROVIDING ASSISTANCE ANYWHERE IN THE WORLD

Disaster Assistance Response Team (DART)

DART consists of about 200 CAF staff who can quickly fly into disaster areas around the world.

The primary goal is to provide emergency services, such as drinking water and medical treatment until long-term aid arrives but its missions last no longer than 40 days.

The Canadian government makes the decision to send **DART**, after it receives a request from an individual country or the United Nations.

Almost everything **DART** needs — including over 40 vehicles, 340 tonnes of supplies, 11 tonnes of medical supplies — is stored at CFB Trenton, ready to ship within 48 hours.

DART's medical aid station can serve up to 250 outpatients and 10 inpatients a day and its water purification system can produce 50 000 litres of clean drinking water per day as well as chlorinate wells and inspect water supplies.

DART has deployed on: Op CENTRAL (Honduras, 1998); Op TORRENT (Turkey, 1999); Op STRUCTURE (Sri Lanka, 2004); Op PLATEAU (Pakistan, 2005); and Op HESTIA (Haiti, 2010).

When the CAF needs to move people, supplies or equipment anywhere in the world fast it uses the huge **CC-177 Globemaster**. With a wingspan of 174 feet (53.04m), a range of 4 025 miles (6 482 km) and a payload of 86 000 pounds / 43 tonnes (39 000 kg) it is ideally suited for the task.

Deployed Technical Assistance Laboratory (DTAL)

Through the door of what looks like an ordinary ocean freighter shipping container is a world of high-tech machines and highly trained technicians working to identify terrorists or anyone hoping to harm Canadian soldiers — this is **DTAL**, the Crime Scene Investigators (CSI) of the CAF.

High-tech equipment is illuminated by fluorescent blue lights, and pictures of fingerprints, facial shots and other identifying markers line the walls.

Two fully stocked, highly advanced **DTALs** sit in 11 twenty-foot containers that can be shipped by road, rail, ship and aircraft to anywhere around the world and be operational within 24 hours.

DTAL analyzes items such as cell phones, narcotics and improvised explosive devices (IED) looking for facial, retinal and fingerprint images which the **DTAL** team can check against authorized databases and records of known terrorists and illegal groups.

DTAL belongs to the Canadian Army but all branches of the CAF work in the lab. **DTAL** supports the entire CAF and other Canadian and international agencies.

THIS PAGE INTENTIONALLY LEFT BLANK

QUESTIONS

1. What does the acronym DART mean?
2. What does the acronym DTAL mean?
3. What is the name of the airplane used by the CAF to transport huge amounts of supplies and equipment?
4. Where is the DART equipment housed?
5. Where is DTAL housed?
6. Who decides to send DART on a mission?
7. How long is DART's usual mission?
8. How quickly can DART be deployed?
9. How many outpatients can DART's medical aid team see in a day?
10. How many litres of water can DART produce in a day?
11. What lines the walls of the DTAL?
12. What color lights illuminate the DTAL?
13. What does DTAL do with images it finds on the equipment it analyzes?
14. To which branch of the CAF does DTAL belong?
15. Who does DTAL support?

THIS PAGE INTENTIONALLY LEFT BLANK

ANSWER SHEET

1. What does the acronym DART mean? **Disaster Assistance Response Team**
2. What does the acronym DTAL mean? **Deployed Technical Assistance Laboratory**
3. What is the name of the airplane used by the CAF to transport huge amounts of supplies and equipment?
C-17 Globemaster
4. Where is the DART equipment housed? **CFB Trenton**
5. Where is DTAL housed?
Eleven 20 – foot ocean freighter shipping containers
6. Who decides to send DART on a mission? **The Government of Canada**
7. How long is DART's usual mission? **No longer than 40 days**
8. How quickly can DART be deployed? **48 hours**
9. How many outpatients can DART's medical aid team see in a day? **250**
10. How many litres of water can DART produce in a day? **50 000 litres**
11. What lines the walls of the DTAL?
Pictures of fingerprints, facial shots and other identifying markers
12. What color lights illuminate the DTAL? **Blue fluorescent lights**
13. What does DTAL do with images it finds on the equipment it analyzes?
Checks them against authorized databases of known terrorists and groups.
14. To which branch of the CAF does DTAL belong? **Canadian Army**
15. Who does DTAL support?
All branches of the Canadian Armed Forces and other Canadian and international agencies

THIS PAGE INTENTIONALLY LEFT BLANK

CANADIAN ARMED FORCES (CAF) CAREERS

OBJECTIVE: The aim of this activity is to familiarize the cadets with the types of jobs available in the CAF.

TIME: 15 minutes

TRAINING LEVEL: 1–4

PRE-ACTIVITY INSTRUCTIONS:

- This learning station may be assigned an instructor or be self directed by the cadets.
- Photocopy the Matching Challenge Cards, located at Appendix 1.
- Decide which matching activity strategy will be used.
- Cut out the Matching Challenge Cards so that each page produces four cards: two labelled Occupation Pictures and two Occupation Descriptions.

ACTIVITY INSTRUCTIONS:

Have the cadets match the Occupation Pictures with the Occupation Descriptions by participating in one of the following activities.



Keep an original copy of the Card Matching Challenge that has not been cut into cards, to verify that the cadets have made a correct match.

Option A – Simple Match (Large Group). As a large group, place the cards on the table and have the cadets match the Occupation Pictures with the Occupation Descriptions.

Option B – Simple Match (Small Groups)

1. Determine the number of small groups and separate the cards into the same number of groups ensuring the corresponding Occupation Picture and Occupation Description are in the same group.
2. Have the cadets place the cards on a table and match the Occupation Pictures with the Occupation Descriptions.

Option C – Job Fair

1. Separate the cadets into two equal groups. Give the cards containing Occupation Pictures to the cadets in the first group and the cards containing Occupation Descriptions to the cadets in the second group. If there are less than 10 cadets in each group, some cadets may end up with more than one card. Conversely, if there are more than 10 cadets in each group, some cadets may have to work in pairs or groups.
2. Have the cadets in the Occupation Pictures group stand in one spot in the room and call out their occupation (eg, 'Boatswain' or 'I am a Boatswain').
3. Have the cadets in the Occupation Descriptions group read their card and walk around the room 'seeking' the picture of their described occupation.
4. Once the cadets have a match, have them verify their match with their partner then link arms until all cadets match their cards.
5. Have the cadets show their matched cards, reading the occupation name and one or two occupation description points.

Option 4 - Guess Who?

1. Display the Occupation Pictures on the wall around the room.
2. Divide the cadets into pairs and give the first partner the Occupation Description. The first cadet should not show or share the information with their partner.
3. Have the second cadet begin by asking the first partner "Can you guess who am I?"
4. Have the first cadet reply by giving the second cadet clues to help them locate the appropriate card on the wall.
5. Have the second cadet begin by saying "You...." followed by small clues (eg, "You work in the field," "You dress in green," "You help people.")
6. Have the cadets stand with linked arms beside their picture when they are done.



The instructor may create Guess Who? board game set(s), similar to the original Hasbro versions.

MATCHING CHALLENGE CARDS



Combat Engineer

Occupation Description:

- Construct and maintain roads, airfields, heliports, bridges, causeways, rafts, permanent and temporary buildings.
- Provide drinking water by testing, purifying and filtering local supplies and by constructing local distribution systems.
- Detect and dispose of mines and bulk explosives.
- Demolish roads and bridges, and lay minefields to prevent enemy movement.



Ammunition Technician

Occupation Description:

- Manage the storage of ammunition.
- Prepare and ship ammunition.
- Maintain static facilities, field and deployed installations.
- Perform safe disposal procedures on explosive ordnances.
- Conduct improvised explosive devices disposal operations.



Hull Technician

Occupation Description:

- Maintain and repair ship piping systems, pumping and flooding systems, steam heating and de-icing equipment, and the ship's pollution and sanitation systems.
- Perform arc and oxyacetylene welding.
- Perform carpentry and painting to maintain and repair ship fittings.
- Operate and maintain firefighting and damage repair equipment.
- Calculate ship stability and identify potential problems.



Maritime Surface and Sub-surface (MARS) Officer

Occupation Description:

- Act as an Officer of the Watch in Canadian Naval ships.
- Provide expertise in a wide range of activities.
- Direct and conduct strategies, tactics and procedures in the operation of ships, submarines, aircraft, maritime sensors, combat information and weapons systems.
- Provide input into the design, procurement and evaluation of ships or systems.



Infantry Soldier

Occupation Description:

- Operate and maintain a wide range of weapons, including rifle, hand-grenades, light, medium and heavy machine-guns, and anti-tank weapons.
- Use sophisticated equipment for field communications, navigation and night-vision surveillance.
- Engage in unarmed combat.
- Employ camouflage and concealment, patrol, assault, defence, and escape-and-evasion tactics.



Artillery Officer

Occupation Description:

- Operate and manage field guns, rockets, missile systems and target acquisition systems.
- Become an expert with laser range finders, fire control computers, and communication systems.
- Work with Global Positioning Systems (GPS), surveillance equipment and unmanned aerial vehicles.



Boatswain

Occupation Description:

- Operate and maintain shipboard equipment associated with cargo handling, anchors & materiel transfer at sea.
- Operate and navigate small craft.
- Plan, organize and conduct drill and ceremonies.
- Assist and supervise deck crews in maintaining the ship and its equipment including scraping and painting.
- Coordinate watch keeping duties at sea and in harbour.



Electrical Technician

Occupation Description:

- Operate and monitor electrical power-generating and distribution equipment.
- Provide electrical maintenance support for all engineering machinery and auxiliary equipment throughout the ship.
- Operate battery chargers, electrical switchboards and metering devices.
- Assist in testing, tuning, repairing, installing and inspecting electrical and electronic equipment systems.



Pilot



Air Combat Systems Officer

Occupation Description:

- Conduct flight operations with various RCAF aircraft.
- Plan, communicate, coordinate and execute tactical missions in support of civil authority or military objectives.
- Support humanitarian and disaster relief, and air intercept operations.
- Work with sophisticated technology for precision tactical navigation systems, advanced communication systems, sensor systems, counter-measure systems and weapon delivery systems.

Occupation Description:

- Conduct search and rescue, anti-submarine operations.
- Perform maritime surface surveillance and targeting.
- Take part in sovereignty and fisheries patrols, counter-narcotics operations.
- Train in electronic warfare and unmanned aerial vehicle operation.



Aircraft Structures Technician

Occupation Description:

- Restore or repair defects using unique aircraft fastening hardware metals, composite materials, chemicals, adhesives, paints and textiles.
- Manufacture and install aircraft structural components for prototype projects.
- Manufacture aircraft equipment from base metals using special cutting tools, engine lathe and milling machines.
- Fabricate and repair aircraft structures using various materials.

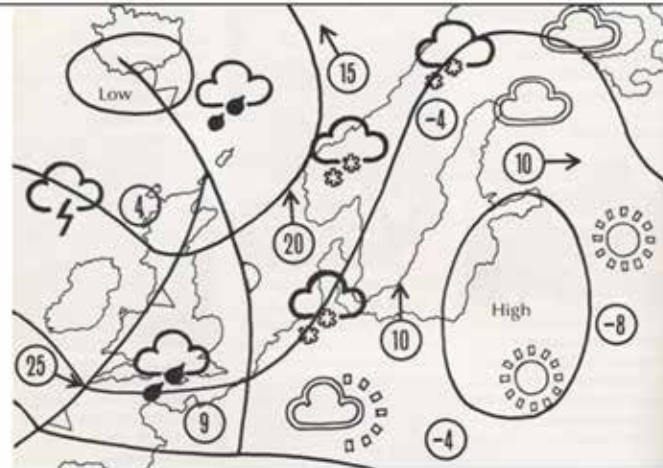

Meteorological Technician

Occupation Description:

- Observe and record surface, marine and upper air weather conditions
- Process, analyze and interpret meteorological information.
- Operate and maintain specialized meteorological instruments and equipment.
- Brief wing, ship and land unit personnel on actual and expected weather conditions.
- Forecast weather conditions.



Dental Technician



Medical Technician

Occupation Description:

- Perform preventive dentistry procedures and give preventive dentistry instruction.
- Produce dental x-rays and preliminary impressions for study casts.
- Perform clinical dental laboratory procedures.
- Perform preventive maintenance on dental equipment.
- Operate and maintain the Air Transportable Dental System.

Occupation Description:

- Provide initial care for patients.
- Prescribe some medications in accordance with their scope of practice.
- Participate in rescues from crashed vehicles, tanks, ships, aircraft and damaged buildings.
- Collect specimens and perform basic laboratory procedures.
- Perform electrocardiograms and audiograms



**Resource Management
Support Clerk**



Cook

Occupation Description:

- Control pay and leave documentation.
- Create and distribute letters to other military and civilian groups.
- Human resource administration and services.
- Financial management support services.
- Personnel support services.
- Corporate and general purpose administration.

Occupation Description:

- Operate, clean and maintain food services equipment and facilities.
- Assist in the handling and control of food and non-food supplies.
- Prepare and serve meals that range from cafeteria-style menu items to formal multi-course meals for military and civilian dignitaries.



Construction Technician



Special Operations Forces

Occupation Description:

- Construct, repair and maintain buildings for the protection of personnel and equipment
- Produce related structural designs and specifications
- Produce related structural drawings
- Construct field defences
- Harden field structures
- Erect prefabricated structures

Occupation Description:

- Train in advanced armed defence techniques.
- Take part in counter-terrorism operations and armed assistance.
- Render armed assistance in to support Canadian national security.
- Take part in various military operations, which may include, but are not limited to, surveillance, security advice and close personal protection.



Search and Rescue Technician

Occupation Description:

- Conduct Search and Rescue operations on the ground, at sea, and in the air.
- Train and use emergency medical care.
- Train and regularly use parachutes.
- Conduct mountain operations.
- Be on standby and respond to emergencies at a moments notice.



Military Police

Occupation Description:

- Investigate and report incidents involving military or criminal offenses
- Develop and apply crime prevention measures to protect military communities against criminal acts
- Provide security at selected Canadian embassies around the world.
- Perform other policing duties, such as traffic control, traffic-accident investigation, and emergency response.

LIFE IN THE ROYAL CANADIAN NAVY (RCN), ROYAL CANADIAN AIR FORCE (RCAF) OR CANADIAN ARMY

OBJECTIVE: The aim of this learning station is to familiarize the cadets with life in the RCN, RCAF or Canadian Army.

TIME: 15 minutes

TRAINING LEVEL: 1–4

PRE-ACTIVITY INSTRUCTIONS:

- Assign an instructor to this activity.
- Choose and download one of the videos from www.forces.ca/en/media, www.forces.ca> WHO WE ARE > LIFE IN THE FORCES > Navy, Army, Air Force, Reserve Force, the section includes:
 - Life in the Royal Canadian Navy (RCN), 9:30 min
 - Life in the Canadian Army, 7:50 min
 - Life in the Royal Canadian Air Force (RCAF), 7:53 min
- Gather the required resources: Multimedia equipment (laptop / projector / speakers).

ACTIVITY INSTRUCTIONS:

1. Have the cadets watch one of the videos.
2. Following the video, have a discussion about what the cadets learned from it. Questions can include:
 - (a) Name one thing you learned about life in the RCN / RCAF / Canadian Army?
 - (b) Did you see anything that the RCN / RCAF / Canadian Army do that you do as a cadet?
 - (c) What types of jobs do the RCN / RCAF / Canadian Army do that keep you safe?

THIS PAGE INTENTIONALLY LEFT BLANK



**COMMON TRAINING
ALL TRAINING LEVELS
INSTRUCTIONAL GUIDE
CANADIAN ARMED
FORCES FAMILIARIZATION**



SECTION 9

EO CX20.01 – PARTICIPATE IN CAF FAMILIARIZATION ACTIVITIES

Total Time:

Six sessions (18 periods)

**THERE IS NO INSTRUCTIONAL GUIDE PROVIDED FOR THIS EO. REFER TO
THE LESSON SPECIFICATION LOCATED IN A-CR-CCP-701/PG-001, ROYAL
CANADIAN ARMY CADETS GREEN STAR QUALIFICATION STANDARD AND PLAN.**

THIS PAGE INTENTIONALLY LEFT BLANK

CHAPTER 11

**PO 121 – PARTICIPATE AS A MEMBER OF A TEAM DURING
AN OVERNIGHT BIVOUAC FIELD TRAINING EXERCISE (FTX)**



ROYAL CANADIAN ARMY CADETS
GREEN STAR
INSTRUCTIONAL GUIDE



SECTION 1
EO M121.01 – SELECT PERSONAL EQUIPMENT

Total Time: 60 min

PREPARATION

PRE-LESSON INSTRUCTIONS

Resources needed for the delivery of this lesson are listed in the lesson specification located in A-CR-CCP-701/PG-001, *Green Star Qualification Standard and Plan*, Chapter 4. Specific uses for said resources are identified throughout the instructional guide within the TP for which they are required.

Review the lesson content and become familiar with the material prior to delivering the lesson.

PRE-LESSON ASSIGNMENT

Nil.

APPROACH

The group discussion was chosen for TP 1 as it allows the cadets to interact with their peers and share their knowledge, experiences, opinions and feelings on what needs to be considered when selecting clothing for an outdoor activity. Sharing in the group discussion encourages the cadets to examine their own thoughts and may prompt them to re-think their previously held ideas. Participating in a group discussion improves the cadets' listening skills and team development.

An interactive lecture was chosen for TPs 2 – 4 to introduce the cadets to the types of sleeping bags and additional items required for an outdoor activity.

INTRODUCTION

REVIEW

Nil.

OBJECTIVES

By the end of this lesson the cadets shall be expected to select appropriate personal equipment for participation in a field training exercise (FTX). Cadets shall be able to identify the layering system, choose suitable clothing for the weather conditions, select sleeping equipment, and identify additional items that may be required for a FTX.

IMPORTANCE

Understanding the basic requirements of personal equipment for a FTX will allow the cadets to be prepared for the weather conditions, to be comfortable in their environment, and to prepare themselves for participation in upcoming exercises.

Teaching Point 1**Explain considerations when selecting clothing for an outdoor activity.**

Time: 20 min

Method: Interactive Lecture

LAYERING SYSTEM

The most effective way to maintain warmth and comfort in varying cold conditions is by using multiple clothing layers, rather than just one garment. Layers allow you to build a tiny microclimate that surrounds your body which can be adapted to moisture, wind, temperature and exertion levels.

Principles of Layering

Temperature control

- The temperature of air around the body will heat and cool according to the:
 - amount of activity being conducted,
 - ambient temperature,
 - weather changes and time of day (i.e., wind, rain, snow), and
 - altitude.
- The simplest way to control such temperature changes of the body is through effective layering.

Insulation

- Insulation slows the rate of heat transfer. The warmth of a garment may be considered as its ability to hold heat. The more heat it can hold over time, the more slowly it transfers heat away from the body, and the warmer the garment is.
- The ideal insulation would weigh next to nothing, be as thin as a tissue, and be compressible down to a tiny volume.

Materials

Synthetic Materials	
Polypropylene	<ul style="list-style-type: none"> • Man made fabric with many properties of wool • Relatively inexpensive • Same material as milk bottles • Base layer
Polyester	<ul style="list-style-type: none"> • High resilience and loft • Light weight • Clean, odourless and non-allergenic • Will not develop mildew
Acrylic	<ul style="list-style-type: none"> • Not often used • Good insulating properties • Inexpensive • Wears well

Tyvek	<ul style="list-style-type: none"> • Not very durable • Doesn't breath
Coolmax	<ul style="list-style-type: none"> • A patented polyester fabric • Great wicking properties • Base layer
Gore-tex	<ul style="list-style-type: none"> • Wind and water resistant • Limited breathability • Outer layer
Thermax	<ul style="list-style-type: none"> • Fine weave polyester • Dries quickly • Base layer

Natural Fabrics

Cotton	<ul style="list-style-type: none"> • Absorbs and holds moisture • Poor material for base layer • Can lead to hypothermia (cotton stores moisture, when cooled the body cools). • May be worn as an insulating layer a sweater
Wool	<ul style="list-style-type: none"> • Doesn't absorb moisture • Retains insulation properties when wet • Best used as insulation
Silk	<ul style="list-style-type: none"> • Great insulating characteristics in very thin fabrics • Very comfortable next to skin • Somewhat fragile (must be laundered and dried carefully)

Types of Layers

Layering allows a person to micro adjust the immediate climate next to the body. This layering structure can be broken into three groups.

Base Layer. This layer actually touches the skin. During hiking, paddling or climbing, the body sweats to cool itself. As the base layer comes in direct contact with your skin, it must be a material that keeps the body warm even when wet. This layer should transport moisture away from the skin and disperse it to the air or outer layers where it can evaporate. This is known as wicking (i.e. wicking layer). The best base layer materials are synthetics, **polypropylene** and **polyester**. These materials are available in three different weights, all containing the same characteristics as listed below.

- Types
 - Light weight – suits high aerobic activity where sweat distribution is greatest.
 - Medium weight – provides moisture control and insulation for stop-and-go activities.
 - Heavy weight – best in cold conditions, or when relatively inactive.
- Characteristics
 - Light and strong
 - Absorbs very little water
 - Quick to dry



Remember water (sweat) is a good heat conductor. Damp clothes draw heat from the body, even in conditions above freezing. This rapid heat loss can cause a dangerous drop in the body's temperature.

Insulating layer. This is the mid-layer that provides insulation and continues the transportation of moisture from the inner layer. To slow heat loss, this layer must be capable of retaining the warmth generated by the body. This is accomplished by the structure of the fibres creating small air spaces that trap molecules of warm air. Additional features, such as pit zippers and full-length front zippers, allow venting. As with the inner layer, this layer should be snug but not constricting.

Outer Layer. The wind breaking and / or waterproof shell is the outer layer that protects a person from the elements and should allow air to circulate and excess moisture to escape. For dry conditions, a breathable (uncoated) wind shell or a smooth-surfaced soft shell may be all that is needed. If expected conditions are more severe, a waterproof (coated) rain jacket maybe more effective. A shell made of a breathable and waterproof fabric protects from wind and rain, and allows water vapour to escape.

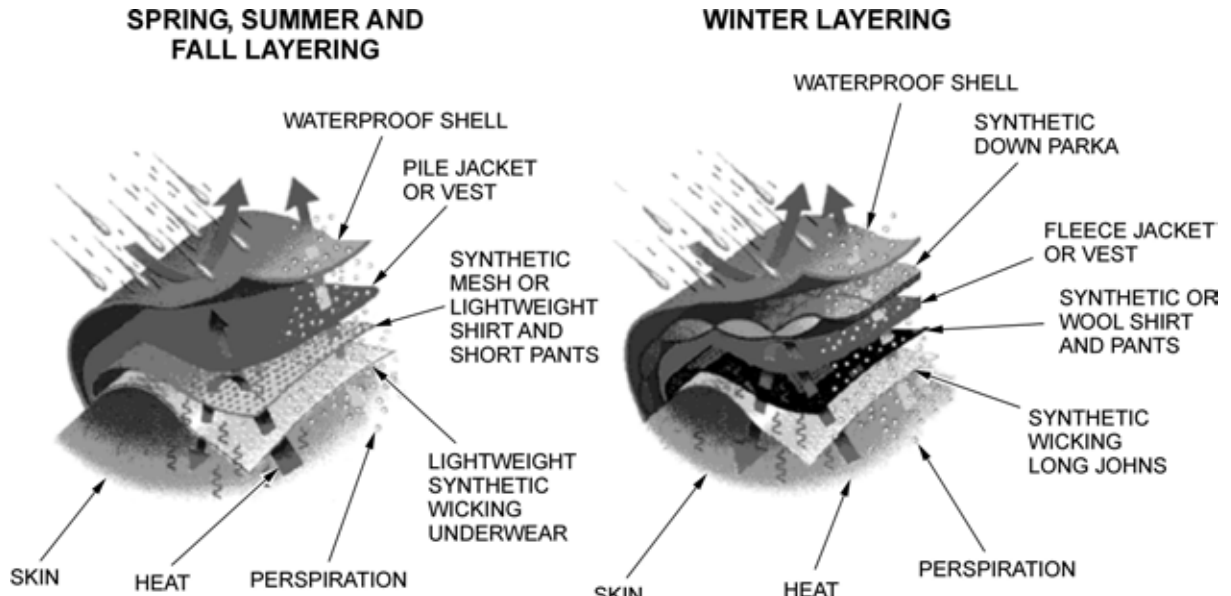

Hiking and Backpacking, A Complete Guide, by Karen Berger, 1995

Figure 1 Layering

DRESSING THE BODY

There are many ways to dress for most activities. Being warm and dry allows you to concentrate on, and enjoy, the activities being conducted. Insulating thickness is a determined variable based on the activities being

conducted and then adjusted to fit the particular circumstance. Employing the layering method is the best way of controlling body temperature.



Remember:

- It is much easier to stay warm than to try to warm up after getting cold.
- It takes much more insulation to stay warm when sitting still than when moving.
- Heat is lost faster to a cold solid object through conduction than to cold air through convection.

A choice must be made as to what clothing will best suit the environmental conditions for a particular body part. There are many parts to consider and many types of clothing to take into account. The following is a list of clothing items for the various parts of the body:

Head and face

- Toque / cap
- Balaclava
- Tilley cap
- Parka hood
- Face mask
- Scarves

Trunk

- Undershirt
- Shirt
- Sweater
- Vest
- Jacket
- Parka

Neck

- Turtleneck
- Neck Gaiter
- Scarves
- High Collar
- Parka Hood

Legs

- Pants
- Insulated pants
- Windbreaker

Hands

- Gloves
- Mittens

ACTIVITY

Time: 15 min

OBJECTIVE

The objective of this activity is for the cadets to gain an understanding of the garments required for a day hike or FTX, taking into consideration the weather conditions expected.

RESOURCES

- Scenarios: Cold weather, wet weather, and hot weather.
- Flip chart paper, and
- Markers

ACTIVITY LAYOUT

Arrange the room for cadets to work in small groups.

The following instructions are suggested:

- Split the cadets into groups of four to six cadets.
- Provide a form of recording material (flip chart and markers)
- Give each group one of the following topics 1) Cold Weather Wear, 2) Wet Weather Wear, 3) Warm Weather Wear.
- Provide the cadets with the details of an upcoming unit exercise.
- Have cadets produce a list of required clothing to suit the environmental condition they were assigned.

ACTIVITY INSTRUCTIONS

- Divide the cadets into at least three groups.
- Provide each group with a different scenario. If there are more than three groups, two groups or more may work on a similar scenario.
- Have the cadets develop a list of clothing articles that will be required for the presented scenario.
- Have the cadets present their list to the rest of the class.
- Allow cadets from other groups to discuss the lists that were developed.

SAFETY

Nil.

CONFIRMATION OF TEACHING POINT 1

QUESTION:

- Q1. What layers make up the layering system?
- Q2. What is the best base layer material?
- Q3. Give an example of a natural fibre.

ANTICIPATED ANSWERS:

- A1. Base layer, insulating layer, outer layer.
- A2. Polypropylene.
- A3. Silk, wool, cotton.

Teaching Point 2

Discuss the considerations for selecting a sleeping bag for an outdoor activity.

Time: 10 min

Method: Interactive Lecture

INSULATING MATERIAL

Sleeping bag insulation is divided into two categories, natural and synthetic.

Natural insulation is usually waterfowl down – the short feathers closest to a duck's, or goose's, body that insulate the animal when in cold water. There is a variance in quality of down and the methods used to secure it in place inside the bag's inner and outer shell. Down sleeping bags are measured according to their fill-power





(FP) cubic inches per ounce of down. A good quality down-blend is around 550 FP. Look for a bag with good quality down with the insulation held in place by “baffles” – dividers sewn between the two shells that keep the down in place. Down is the warmest and lightest insulation that can be found in a sleeping bag; however, it loses almost all of its heat retaining ability when it gets wet and it is very difficult to dry in the field.

Synthetic insulation is comprised of plastic threads that are either continuous long filaments or short staples (pieces about five centimetres long) and may be hollow. Short staples may be a mixture of thin and thick pieces. Thinner, lighter threads fill voids and trap warm air effectively while providing loft and durability.

Some bags offer more insulation on the top than on the bottom. Avoid bags where the insulation is secured by sewing the two shells together creating seams where there is no insulation. Most synthetic insulation retains its insulative value when wet. Some synthetics are very light and warm – they make a better all-round choice than down for a general purpose sleeping bag. In sleeping bags, cost often is a good indicator of the quality of the bag.

SLEEPING BAG CONSTRUCTION

Methods

 <p>www.mec.ca/main/content</p> <p>Sewn-through is used in lightweight or warm-weather synthetic or down bags, but can have cold spots at quilt lines.</p>	 <p>www.mec.ca/main/content</p> <p>Offset Quilt is used for synthetic bags only. It has no cold spots at quilt lines and is less expensive than shingled construction.</p>	 <p>www.mec.ca/main/content</p> <p>Shingles are used for synthetic bags only. It is the most warmth-to-weight efficient construction, but is more expensive than offset quilt.</p>	 <p>www.mec.ca/main/content</p> <p>Baffles are used in down bags only. They feature mesh partitions at quilt lines to prevent cold spots and keep down from migrating through the bag. Expensive, but very warm.</p>
--	---	--	---

Sleeping bag parts

Outer shell – constructed from a lightweight fabric, often nylon or polyester. It should be of sufficient weight and quality to protect the insulation layer.

Inner shell – constructed from a lightweight fabric. Look for an inner shell that does not retain moisture. Many inexpensive bags use cotton / flannel inner shells, which are comfortable, but not ideal for a hiking or expedition bag, as cotton takes too long to dry.

Hood – a part of the main bag that can be pulled around your head in cold weather. This keeps your head warm without a build up of moisture from your breath in the bag.

Liner – a thin bag you place inside your main bag to help keep the main bag clean and to offer a little more insulation.

Over bag – a durable bag placed over your main bag to protect the outer shell, and to offer more insulation. Over bags made from waterproof and waterproof-breathable material can be used as mini-shelters. There are

several good designs of these “bivi-bags” that have screened openings to protect your face from bugs and to allow some ventilation in warm weather.

TYPES OF SLEEPING BAGS

The choice of a sleeping bag has a lot in common with the personal choice of outdoor clothing. It must be the right size (length and width), have the appropriate amount of insulation for the coldest expected temperature, be made of a material that breathes and doesn't retain moisture, and have a good quality fastener (zipper).

When choosing a sleeping bag, check the bag size by getting in and moving around. There should be some space for a liner and extra clothes in cold weather. Ensure to have enough room to move arms around, the ability to zip up from the inside, and enough room around the feet so that they can rest in a comfortable position. Bags come in three basic styles, each one offering its own advantages.

Mummy Bag. Acquired its name by the occupant resembling an ancient Egyptian mummy when in it! The bag tapers from the opening following the contours of the body closely. There is very little extra air space once in the bag. The zipper may only reach halfway down the side of the bag and is protected by an insulated flap (called a “draft tube”). The opening of the bag will have an insulated hood with a draw cord to pull the hood snug around the face to keep warm air in. Mummy bags are designed to save weight and maximize heat retention, are best suited for extreme cold, and will come with two separate bags, an inner and outer, which are used together. The mummy bag is certainly the warmest of the bag styles.



www.mec.ca

Figure 2 Mummy Bag

Barrel Bag. This is a compromise between the efficiency of the mummy design and the economy of the rectangular bags. The shape tapers from the opening towards the foot, but is still considerably roomier than a mummy. Quite often there will be a hood with a draw cord, or at least an extension of one side of the opening that offers some head insulation. Depending on the insulation, this design is a good choice for spring, summer and fall camping.



www.mec.ca

Figure 3 Barrel Bag

Rectangular Bag – the most common economical bag. The zipper often opens fully to create a double sized blanket. This style is roomy and can be useful for warm weather camping or indoor accommodation. The disadvantages as a bag for hiking or expeditions are numerous. The extra air space around the torso, legs and feet means that it takes more heat energy to heat up and keep the space warm. The extra material means the bag is bigger and heavier. There is no protection for the head in cold weather. The liner materials used tend to retain moisture and odours.



www.mec.ca

Figure 4 Rectangular Bag

Military Bag. Based on the 1951 pattern, this sleeping bag consists of five main parts:

1. **The cover** of the sleeping bag is made of a moisture proof nylon. The cover's main purpose is to keep the bag clean and protect it from moisture.
2. **The outer bag** is down filled with a composition of 40% down and 60% feathers.
3. **The inner bag** is made in the same way as the outer. The inner bag is secured to the outer bag and liner using a series of ties.
4. **The liner** is flannelette and attaches to the inner bag.
5. **The Hood** (not shown) is pulled over the head and secured by straps pulled underneath the armpits.



Figure 5 The Outer Bag



Figure 6 The Inner Bag



Figure 7 The Liner

CONFIRMATION OF TEACHING POINT 2

QUESTIONS:

- Q1. What are the two types of insulation used in sleeping bags?
- Q2. If you were planning to go on an over night winter FTX and the projected weather was expected to be extremely cold, what would be the best style of sleeping bag to take for the cold temperatures?
- Q3. With the approach of the new cadet year you expect to do a fair amount of sleeping in the field. You decide to look for a naturally insulated sleeping bag to purchase. What fill power would you look for in a naturally insulated sleeping bag?

ANTICIPATED ANSWERS:

A1. Natural and synthetic.

A2. Mummy style.

A3. 550 FP.

Teaching Point 3

Time: 10 min

Describe sleeping pads.

Method: Interactive Lecture

SLEEPING PADS

A sleeping pad is the foundation of a sleeping system. The pad cushions against the hard ground, and keeps a warm thermal barrier between the ground and the sleeping bag. Choose a pad that is appropriate for the activity being participated in and the weather expected. The colder the ground temperature, the more insulation needed. Pads come in several lengths and designs.

Closed cell foam pad – the foam is lightweight and doesn't absorb water. Foam pads come in a variety of individual thicknesses, depending on desired amount of insulation and comfort. Most foam pads are low priced and durable.



Figure 8 Closed Cell Foam Pad

Air mattress– rubber, vinyl or a combination of materials in a variety of thicknesses. Usually they are heavier than a foam pad, but offer good insulation when fully inflated. Disadvantages include being easily damaged and taking a long time to inflate for use and deflate to pack. In cold weather, if the air mattress is inflated by mouth, ice crystals will form inside from the moisture in your breath and will provide less insulation from the ground than dry air (later, in the warmth, the moisture will cause your mattress to rot).



Figure 9 Air Mattress

Self-inflating foam-air combination pads– these pads use foam as well as an adjustable valve to create a quick-to-inflate pad that offers better thermal insulation, is much more comfortable and warm and that it is light-weight like a foam pad.



Figure 10 Self-Inflating Air Combo Pad

CONFIRMATION OF TEACHING POINT 3

QUESTIONS:

- Q1. What type of sleeping pad does not require inflation?
- Q2. Name a disadvantage of the air mattress.
- Q3. Name an advantage of the self-inflating pad.

ANTICIPATED ANSWERS:

- A1. The closed cell foam pad does not require inflation.
- A2. Punctures easily, considerable time to inflate / deflate, ice crystals may form inside the mattress.
- A3. Very comfortable, warmer, lightweight and better thermal insulation.

Teaching Point 4**Select additional personal equipment.**

Time: 10 min

Method: Interactive Lecture

ACCESSORIES

During any hike or weekend exercise there is always a need to carry additional items that may not be necessarily required for the exercise itself. Some small pieces you should always carry in your pack when preparing for a hike are:

- **Bug repellent.** The active ingredient in bug repellent is DEET. Many brands are available; however, the greater the concentration the more effective it is.



Caution: DEET in high concentrations may cause health problems. Health Canada has banned any products with DEET concentrations over 30%.

As stated from the Public Health Agency of Canada:

- Children from birth to 2 years are not to use insect repellents containing DEET.
- Children between 2-12 years are to apply no more than three time a day, using the lowest concentration of DEET (10% or less).
- Individuals 12 years or older are to apply insect repellents containing no more than 30% DEET.

- **Flashlight.** To provide light in the dark, a flashlight should always be carried, the smaller the better for weight reasons (be sure to have a spare set of batteries and bulb before each trip).
- **Lip Balm.** Lips burn easily at any elevation and in cold the dry winds can make lips crack and bleed.

- **Map and compass.** Any time when going into the field a map and compass should be taken. Becoming turned around and lost could happen to anyone.
- **Matches.** At least 20, the kind that will strike anywhere and are waterproof. Store matches in a separate container inside your kit with a striker (35 mm film cases would suffice).
- **Notepad and pencil.** Allows for note taking and / or leaving a message.
- **Pocketknife or multi-tool.** Useful tool for many applications in the field. Hunting type knives with long fixed blades are not appropriate for most cadet activities.
- **Sunscreen.** A Sun Protection Factor (SPF) of 15 means that a person can remain in the sun without burning their exposed skin for 15 times longer with the protection than they could without it. Most sunburns can be prevented with a SPF of 15, however a SPF of 29 or higher is recommended.
- **Survival kit.** Reflects the needs of the user. Fill with items that you can use and that reflect the environment you will be travelling in.
- **Whistle.** Signalling device.



Testimonials detailing how lack of preparation led to discomfort in the outdoors will serve to reinforce the teaching points.

CONFIRMATION OF TEACHING POINT 4

QUESTIONS:

- Q1. What are five accessories that should be brought on a hike or FTX?
- Q2. What is the minimum number of matches that should be taken on an overnight exercise?
- Q3. What is the active ingredient in bug spray?

ANTICIPATED ANSWERS:

- A1. Answers may vary. Answers not listed above may be valid.
- A2. The minimum number of matches that should be taken on an overnight exercise is 20.
- A3. DEET is the active ingredient in bug spray.

END OF LESSON CONFIRMATION

Cadets will be expected to select their own equipment when packing for a FTX. The instructor will assess this selection informally when the cadet arrives for the FTX.

CONCLUSION

HOMEWORK/READING/PRACTICE

Cadets will be expected to select their own equipment and pack it for all FTXs.

METHOD OF EVALUATION

Nil.

CLOSING STATEMENT

Understanding what personal equipment is required for an outdoor activity allows to be prepared for conditions and to be comfortable in the environment. This is particularly important as outdoor activities represent a big part of the Army Cadet Program.

INSTRUCTOR NOTES/REMARKS

This lesson should be delivered prior to the bivouac FTX.

Cadets' backpacks should be verified for proper equipment prior to the FTX.

REFERENCES

A2-010 B-GG-302-002/FP-001 FMC. (1982). *Basic cold weather training, arctic and sub arctic operations* (vol. 2). Ottawa, ON: The Department of National Defence.

C2-009 Harvey, Mark (1999) *The national outdoor leadership school's wilderness guide*. New York, NY: Fireside

C2-010 0-375-70323-3 Rawlins, C., & Fletcher, C. (2004). *The complete walker IV*. New York, NY: Alfred A. Knopf.

C2-012 0-89886-643-X Weiss, H. (1988). *Secrets of warmth for comfort or survival*. Seattle, WA: The Mountaineers.



ROYAL CANADIAN ARMY CADETS
GREEN STAR
INSTRUCTIONAL GUIDE



SECTION 2

EO M121.02 – TRANSPORT PERSONAL EQUIPMENT

Total Time: 30 min

PREPARATION

PRE-LESSON INSTRUCTIONS

Resources needed for the delivery of this lesson are listed in the lesson specification located in A-CR-CCP-701/PG-001, *Green Star Qualification Standard and Plan*, Chapter 4. Specific uses for said resources are identified throughout the instructional guide within the TP for which they are required.

Review the lesson content and become familiar with the material prior to delivering the lesson.

PRE-LESSON ASSIGNMENT

Nil.

APPROACH

An interactive lecture was chosen for TP 1 to introduce the cadets to packing personal equipment.

A demonstration was chosen for TP 2 as it allows the instructor to explain and demonstrate the wearing of a backpack.

INTRODUCTION

REVIEW

Review of EO M121.01 (Select Personal Equipment):

- Q1. What are five accessories that should be brought on a hike or FTX?
- Q2. What is the minimum number of matches that should be brought on an over night exercise?
- Q3. What is the active ingredient in most bug spray?

ANTICIPATED ANSWERS:

- A1. Flashlight, lip balm, map and compass, matches, notepad and pencil, flashlight, pocket knife, sunscreen, whistle, survival kit and bug repellent. Other answers may also be correct.
- A2. 20 matches.
- A3. DEET is the active ingredient in bug spray.

OBJECTIVES

By the end of this lesson the cadets will be expected to select, properly pack, and wear a backpack.

IMPORTANCE

This lesson will allow cadets to train in the field, and carry their equipment safely and efficiently.

Teaching Point 1**Explain packing personal equipment.**

Time: 15 min

Method: Interactive Lecture



The objective at the end of this TP is for the instructor to demonstrate to the cadets how to pack a backpack. The backpack should contain the following items:

- Clothing (enough for over night in the field)
- Tent
- Drinking cup
- Sleeping bag
- Rain gear
- Hygiene kit
- Food
- Two garbage bags
- Mountain style individual stove
- Simulated fuel container
- Water bottle
- Pot set
- Survival kit

TYPES OF BACKPACKS

Backpacks come in different sizes, styles and available features. Many backpacks have been developed with specific uses in mind. They can differ greatly in their anatomy and features. Backpacks can be divided into two major categories, external frame and internal frame.

External Frame – These backpacks are constructed with a bag attached to a visible metal or resin frame. Some external frame packs offer a frame that adjusts in length; however, most are not adjustable. It is important to choose a frame that is the correct size. Try the backpack on and ensure the hip pads and hip belt rest snugly on your hips – the shoulder straps should connect to the harness at the same level as your shoulders. External frame packs have both advantages and disadvantages.

Advantages:

- High centre of gravity, aids with walking upright;
- Air flow between backpack and body makes for cool hiking;
- Easy to load;
- Cheaper than internal frame packs;
- Will not sag under heavy loads;
- Frame can be used to make a stretcher to evacuate an injured person; and
- Can carry large and awkwardly shaped objects.

Disadvantages:

- High centre of gravity makes it hard to balance on tricky terrain or when skiing;
- Does not move closely with the body, making it hard to scramble over obstacles; and
- Bulky for air travel.



Figure 1 External Frame Pack

Internal Frame – These packs are constructed with a resin or aluminium frame sewn into pockets in the harness of the bag. Often the frame consists of two “stays” running vertically along the backplane. Aluminium frames are to be moulded to the shape of your back. The bag is designed to carry all your gear internally with only pockets and accessories attached to the outside. Some smaller packs may offer the option of attaching a sleeping bag stuff sack to the top or bottom. Like the external frame packs, it is important to correctly size your internal frame pack. Some models offer a range of backpack sizes and some offer adjustable or replaceable stays.

Internal frame packs have both advantages and disadvantages:

Advantages:

- Backpack rides low and close to the body, allowing freedom of movement and good balance,
- Sleek profile makes it easy to bushwhack, crawl through tight boulder fields, etc,
- Comfortable harnesses, and
- Can be adjusted and moulded to the body.

Disadvantages:

- Difficult to load and pack,
- More expensive than external frame packs,
- Not useful for making stretchers.
- Hard to carry large or awkward objects, and
- Ventilation is restricted across the back.



www.abc-of-hiking.com/hiking-backpacks

Figure 2 Internal Frame

Backpack Features

Backpack features are additional attributes designed into the backpack that allow for efficient packing and carrying. Depending on the intended use of the backpack the following features may be looked for:

- **Bag opening** – The bag opening is an important feature. A small opening aids in weatherproofing but makes packing and unpacking more difficult. A wide opening is handy but the longer zippers or extra fasteners are often more prone to trouble. Ensure that the zipper or fastener for the opening(s) is not at a place that will receive a lot of stress when the bag is packed and carried. If the zipper breaks closing the bag may be difficult! The majority of larger bags will offer two or more compartments inside the pack. This will assist in placing heavier items in the proper place and in keeping kit organized.
- **Shoulder harness** - Simple straps will do for lighter loads, however for heavier loads go for curved, broader and more padded shoulder straps. This will prevent the straps from cutting into the shoulders.
- **Chest Strap / Sternum Strap** – These straps often connect across your chest using a clip-lock. By connecting and tightening them you prevent your backpack from pulling your shoulders back.
- **Hip Belt** – This belt allows the strain of the backpack to move from the shoulders down to the hips and closer to the centre of gravity, making the load more bearable. Look for a hip belt that goes full circle under the lumbar pad. Ensure the pad has soft and broad padding to avoid pressure points that could quickly become painful.



www.abc-of-hiking.com/hiking-backpacks

Figure 3 Attributes Diagram A

- **Compression Straps** – These straps allow for the backpack and loads to be compressed, or squeezed into a smaller package. The tighter and more compact the load, the easier it will be to transport.
- **Quick Release Straps** – Many packs are equipped with a set of shoulder straps designed to release quickly in the event of an emergency, or when time / room demands a timely removal.
- **Inner and Outer Pocket Configurations** – Inner and outer pockets allow for a better separation of provisions, gear and other backpack contents. Outer pockets are mostly used for items that must be available while hiking. Outer pockets should not be over weighted to prevent a shift in centre of balance.
- **Hydration System** – Many packs have either built in water bladders (hydration packs) or have a special pocket for a water bladder and a hole for the drinking tube.
- **Splash Cover** – Backpacks are generally not 100% waterproof. Some backpacks have a built in splash cover which is basically a waterproof cover that encompasses the entire pack.
- **Spin Drift Cover** – On large backpacks the top compartment can be flipped backwards giving access to the backpacks inside compartments.
- **Bungee Cords and Equipment Straps** – Most backpacks have either bungee cords or equipment straps or a combination of both that provide the means to fix equipment to the outside of the backpack (e.g. hiking poles, ice axes, and crampons).



www.abc-of-hiking.com/hiking-backpacks

Figure 4 Attributes Diagram B

PACKING

When preparing for a hiking exercise it is important to pack effectively. Every trip is unique and every backpack is different; however, when following certain principles in packing a backpack one can enjoy any trip with comfort and ease. To ensure a backpack is properly packed ABC's of packing should be employed. These are: **A**ccessibility, **B**alance, and **C**ompactness.

Accessibility - when backpacking, there will always be a requirement to keep certain things accessible. In some cases it is just a matter of convenience. Keeping items one might need during the day handy will save time. Some suggested items to keep accessible are:

<ul style="list-style-type: none"> • Lunch • Water • Maps • Sunscreen 	<ul style="list-style-type: none"> • Extra layers for warmth • Rainwear • First aid kit • Snack Food 	<ul style="list-style-type: none"> • Toilet paper • Toilet trowel • Camera • Sun glasses
---	--	--

Balance – A heavier balanced backpack is easier to carry than a lighter unbalanced pack. If a backpack is too heavy, it will be hard to maintain balance especially when crossing obstacles and navigating sloping terrain. A backpack with too much weight at the bottom will hinder stride. The key is to pack the dense, heavy things in close to the body and at a level between the shoulder blades and the bottom of the rib cage. Items such as food, the tent, and the radio are good items to carry in mid regions of the pack.



CATO 14-37 states that cadets 12 –15 years of age can carry loads weighing less than 25% of their body weight. Cadets at the age of 16 cannot carry a load exceeding 30% of their body weight.

Compactness – When packing gear it is important to pack well and effectively utilize space. A compact backpack will be less awkward to carry. To take advantage of space in the pack, break large units down into

smaller units. Look for dead spaces to fill like pots, pans, cups and shoes. These areas can be filled with food or clothing. Other items can be compressed down to half size using compression sacks. If the backpack has compression straps, it too can be compressed tightly.

Packing Considerations

- Waterproof the sleeping bag and clothes by lining the backpack with a garbage bag. Waterproof small items with zip-lock bags.
- Organize kit into separate stuff sacks, for example:
 - warm underwear, socks, hat and gloves in one sack; and
 - eating utensils, extra flashlight, batteries and toiletries in another.
- Pack food above fuel.
- Pack heavy, dense items like food close into the body.
- Odd items such as shoes can be used to fill small spaces.
- Water should be kept in an easily accessible place.
- Items like maps, first aid kit, lunch and a warm layer of clothing should be kept towards the top or outside pockets.
- Fasten all pockets and avoid letting anything hang out.
- Always protect and pad sharp edges of equipment and tools.

CONFIRMATION OF TEACHING POINT 1

QUESTIONS:

- Q1. Backpacks can be divided into what two categories?
- Q2. Name five backpack features.
- Q3. Name and describe the ABC's to packing.

ANTICIPATED ANSWERS:

- A1. External and internal frame.
- A2. Any five of the following: shoulder harness, chest strap, hip belt, inner and outer pockets, hydration system, splash cover, spindrift cover, bungee cords and equipment straps.
- A3. **A**ccessibility, **B**alance, **C**ompactness (explanations provided above).

Teaching Point 2

Explain and demonstrate how to properly wear a backpack.

Time: 10 min

Method: Demonstration

DONNING A BACKPACK



The instructor should inform the cadets that left-handed people might wish to follow these directions using opposite hands, in order to accommodate the dominant hand.

There are many different ways to pick up and don a backpack. If donning is done incorrectly, a back injury can occur. The following is a step by step method considered safe for donning a backpack:

1. Unlatch hip belt and loosen both shoulder straps.
2. Pick the backpack up with your right hand on the crossbar from which the shoulder straps are suspended and left hand on the right strap lift backpack high enough to rest it on your right knee.
3. Slide right arm through the shoulder strap and swing it onto your back.
4. Put left arm through the other strap.
5. Tighten the hip belt and shoulder straps.
6. Ensure all loose belts or strap ends are tucked in and off you go.



When properly adjusted the backpack should leave shoulders and hips free to move. This allows the individual wearing it to stand erect in a normal position and walk at a normal pace.



- Give cadets the opportunity to practice donning the backpack, as time allows.
- If CF rucksacks are to be used, they should be assessed for proper assembly.

CONFIRMATION OF TEACHING POINT 2

QUESTIONS:

- Q1. What should be loosened prior to donning the backpack?
- Q2. When the backpack is harnessed and on the back, what should one ensure is tucked in?
- Q3. When properly adjusted the backpack should leave the (*blank*) and the (*blank*) free to move.

ANTICIPATED ANSWERS:

- A1. Unlatch hip belt and loosen both shoulder straps.
- A2. All loose belts or strap ends are tucked in.
- A3. Shoulders and Hips.

END OF LESSON CONFIRMATION

QUESTIONS:

- Q1. Backpacks can be divided into what two categories?
- Q2. Name and describe the ABC's to packing.
- Q3. What should be loosened prior to donning the backpack?
- Q4. When the backpack is harnessed and on the back, what should one ensure is tucked in?

ANTICIPATED ANSWERS:

- A1. External and Internal frame.
- A2. **A**ccessibility, **B**alance, **C**ompactness.
- A3. Unlatch hip belt and loosen both shoulder straps.
- A4. All loose belts or strap ends are tucked in.

CONCLUSION

HOMEWORK/READING/PRACTICE

Task the cadets to prepare their own backpacks prior to a field training exercise. Have the cadets bring in their completely packed backpacks for inspection prior to the exercise.

METHOD OF EVALUATION

Nil.

CLOSING STATEMENT

The cadets can now to go into the field and carry their equipment and gear safely and effectively.

INSTRUCTOR NOTES / REMARKS

This lesson should be delivered prior to the bivouac FTX.

Cadets' backpacks should be verified for proper packing during the FTX.

Cadets should transport their personal equipment during the FTX.

REFERENCES

C2-004 1-896713-00-9 Tawrell, P. (1996). *Camping and wilderness survival: The ultimate outdoors book*. Green Valley, ON: Paul Tawrell.

C2-005 0-393-31334-4 Berger, K. (1995). *Hiking and backpacking, a trail side guide*. New York, NY: Norton and Company, Inc.

C2-009 0-684-85909-2 Harvey, M. (1999). *The national outdoor leadership school's wilderness guide*. New York, NY: Fireside.

C2-017 0-7627-0476-4 Roberts, H. (1999). *Basic essentials, backpacking*. Guilford, CT: The Globe Pequot Press.



ROYAL CANADIAN ARMY CADETS
GREEN STAR
INSTRUCTIONAL GUIDE



SECTION 3
EO M121.03 – TIE KNOTS AND LASHINGS

Total Time: 90 min

PREPARATION

PRE-LESSON INSTRUCTIONS

Resources needed for the delivery of this lesson are listed in the lesson specification located in A-CR-CCP-701/PG-001, *Green Star Qualification Standard and Plan*, Chapter 4. Specific uses for said resources are identified throughout the instructional guide within the TP for which they are required.

Review the lesson content and become familiar with the material prior to delivering the lesson.

PRE-LESSON ASSIGNMENT

Nil.

APPROACH

An interactive lecture was chosen for TPs 1 and 2 to introduce the cadets to the types and the care and maintenance of ropes.

A demonstration and performance was chosen for TP 3 as it allows the instructor to explain and demonstrate how to tie various knots, while providing an opportunity for the cadets to practice under supervision.

INTRODUCTION

REVIEW

Nil.

OBJECTIVES

By the end of this lesson the cadet shall be expected to tie various knots and lashings, to include:

- Thumb (overhand);
- Reef (Square);
- Figure of eight;
- Double figure of eight (figure of eight loop, follow through / rewoven, and figure of eight on a bight);
- Clove hitch; and
- Half hitch.

IMPORTANCE

Knots and lashings are all used for binding, building or securing. Cadets will need to use knots when erecting a shelter and building a tent site. As such, it is important to know how to tie knots properly and when and where they should be used.

Teaching Point 1**Explain types of ropes and their common uses.**

Time: 10 min

Method: Interactive Lecture

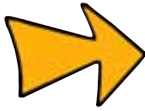

All specialized terms used in this instructional guide are found in the glossary (Attachment A). This handout could be given to the cadets at the end of the lesson.

TYPES OF ROPE

Ropes are made with natural or synthetic fibres. Hemp and manila are the most common natural fibre ropes, although sisal, coir and cotton are also used. Natural fibres are often used in larger sizes for rope bridging because they have limited stretch and are easy to grip when wet.

Natural fibres

Hemp is obtained from the stem of the plant *Cannabis sativa*. This natural fibre makes one of the strongest natural-fibre ropes though it has a tendency to rot if left wet for long periods of time. Hemp ropes need to be frequently tarred – covered with tar, to help prevent rotting.

Manila is the fibre obtained from the wild banana plant, *Musa textiles*. This material is as strong as hemp and more resistant to rot, so it rarely needs to be tarred.

Sisal is a rope-making fibre derived from *Agave sisalana*, a cactus-type plant from Central America. It is weaker than manila or hemp and requires treating with chemicals to make it waterproof and rot-resistant.

Cotton is mainly used to make small ropes and twines. Cotton rots easily; therefore, it needs to be tarred.

Coir is a natural fibre derived from the outer part of the coconut. It is not a very strong material but it is light and has a high degree of stretch. It is the only natural-fibre rope that floats.

Synthetic fibres

Synthetic ropes are usually made from nylon, polyester or polypropylene. Synthetic ropes are generally stronger and lighter than natural ropes.

Nylon ropes are very strong (more than two and a half times the strength of hemp). This rope is mostly used when sudden shock loads may be applied, such as mooring ropes and climbing ropes. It is used for most fishing line when it is spun into a heavy monofilament yarn. Nylon ropes lose about 5 -10 % of their strength when wet. It wears very well, and is resistant to chafe, mildew and rot. Nylon is the strongest of the synthetic ropes.

Polyester, also known as Dracon or Terylene, is weaker than nylon but holds its strength when wet. It resists rot and chafe.

Polypropylene is not as strong as nylon and polyester, but is considerably cheaper. It is light so it will float, making it useful for rescue ropes and short mooring ropes. However, polypropylene does not resist abrasion well.



Over the last few years, additional rope materials have been developed. They are lighter, stronger and have less stretch than most natural and synthetic fibres. These ropes are made of chemicals. Some of these rope materials are Kevlar, Tawron, Technora, Spectra, Dynema, Vectran and Zylon.

CONFIRMATION OF TEACHING POINT 1

QUESTIONS:

- Q1. What are two types of ropes?
- Q2. What are some types of natural ropes?
- Q3. How much strength does a nylon rope lose when wet?

ANTICIPATED ANSWERS:

- A1. Natural and synthetic.
- A2. Hemp, manila, sisal.
- A3. 5 -10%.

Teaching Point 2**Explain the care and maintenance of ropes.**

Time: 5 min

Method: Interactive Lecture

CARE AND MAINTENANCE OF ROPES

Ropes, like other pieces of equipment, require care and maintenance to ensure they are in good condition when needed. The following are some general guidelines for rope care:

Sunlight exposure: All ropes experience deterioration from exposure to ultraviolet sunlight. Ropes are to be stored in cool, dry, and dark locations.

Chemical or fume contamination: If a rope comes into contact with such a substance it may begin to deteriorate. If contaminated, wash with cold running water. Remove oil and grease with mild soap solution.

Storage: Ropes must be stored in bins, on raised surfaces, or hung where air can circulate freely. Ropes must be stored in cool, dry, dark locations to avoid sunlight and excessive heating. Excessive cold will make rope brittle.

Natural wear is unavoidable and, if not excessive, is harmless. Replace lines if approximately 20% wear is evident. Look for chafed areas, rot and fatigue. Serious damage can be seen when the strands are distorted and bear unequal strain.

Cleaning and drying: Depending on frequency of use, ropes should be cleaned according to current condition; a rope that is covered in mud and clay should be washed before its next use. To clean, wash in a sudsy tub of liquid detergent (detergent must be suitable for rope cleaning). Rinse, coil and hang to dry.

**General tips on rope care:**

- Whip, melt (hot knife) or bind the rope ends to keep the rope from unravelling;
- Avoid snagging on, or dragging across, sharp rocks;
- Inspect the rope before and after use for damage;
- Do not step on a rope; and
- Distribute wear on the rope.

CONFIRMATION OF TEACHING POINT 2

QUESTIONS:

- Q1. What effect does sunlight have on ropes?
 Q2. Where should ropes be stored?
 Q3. When should a rope be discarded?

ANTICIPATED ANSWERS:

- A1. All ropes experience deterioration from exposure to ultraviolet sunlight.
 A2. Ropes must be stored in bins, on raised surfaces, or hung where air can circulate freely. Ropes must be stored in cool, dry, dark locations.
 A3. When 20% wear is evident. Look for chafed areas, rot and fatigue.

Teaching Point 3**Explain and demonstrate how to tie knots.**

Time: 65 min

Method: Demonstration and Performance

TYING KNOTS

Before teaching how to tie knots, the following terms shall be clarified, as they will be used to explain how to make the different knots.

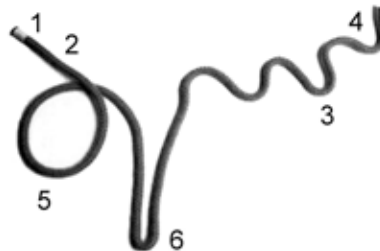

Pocket Guide to Knots and Splices, by Des Pawson, 1991

Figure 1 Parts of a Rope

1. **Working end** (running end) – The end of the rope that is used during the tying of the knot.
2. **Working part** (running part) – The short length of rope that is manipulated to make the knot.
3. **Standing part** – Part of the rope usually 'stands still' during the knot tying process. Often it is the longer end that leads away from the loop, bight or knot.
4. **Standing end** – The end of the rope that not immediately being used in the tying of a knot.
5. **Loop** (crossing turn) – A circle created in the process of tying a knot.
6. **Bight** – Middle part of a length of rope. This term also refers to a loop of rope that does not cross over itself.



These web pages have some excellent animated knots:

<http://www.mistral.co.uk/42brghtn/knots/42ktmenu.html>

<http://www.korpegard.se>

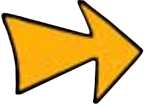

Cadets should be given two short ropes and two small poles in order to tie knots, hitches and lashings along with the instructor.

THUMB KNOT

- **Other names:** Overhand knot, Simple knot.
- **Uses:** Keep the end of a rope from unravelling or to stop a rope from passing through an eye.
- **Qualities:** Easy to make, stays in place.
- **Faults:** It is difficult to untie. An overhand knot in the middle of a length of rope will reduce the strength of the rope by about half.



The instructor shall provide an EXPLANATION and DEMONSTRATION of the complete skill.

The instructor shall also provide an EXPLANATION and DEMONSTRATION of each step required to effectively complete the skill.

Procedure:

1. Form a loop with the working end passing under the standing part of the rope (Diagram 2, Figure 1).
2. Tuck the working end down through the middle of the loop formed by the crossing turn and out of the loop (Diagram 2, Figure 2).
3. Pull both ends to tighten the knot.
4. As it is being tightened, the position of the knot can be moved nearer the end if so required (Diagram 2, Figure 3).

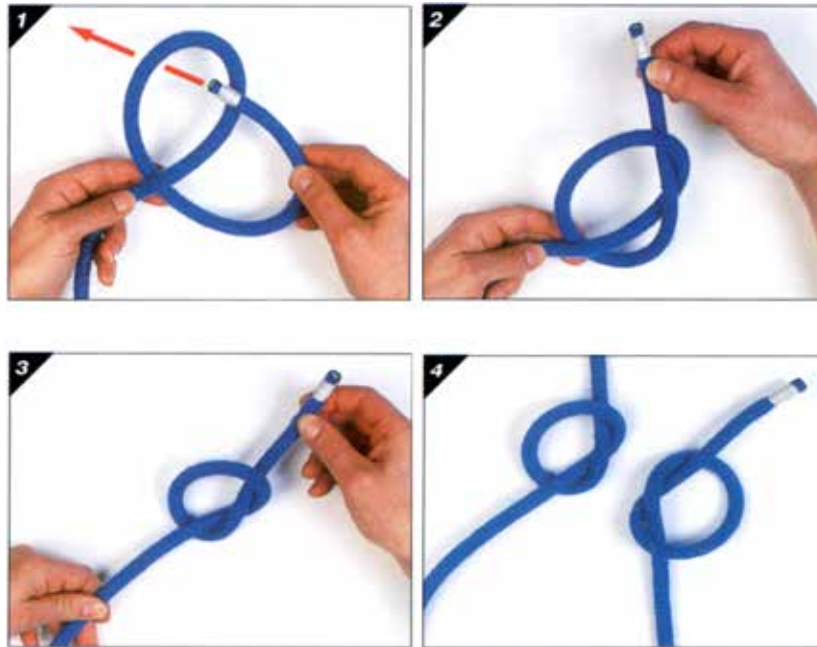

Pocket Guide to Knots and Splices, by Des Pawson, 1991

Figure 2 Thumb Knot



Cadets will IMITATE the demonstration provided by the instructor for each step within the skill. The instructor(s) will SUPERVISE the cadets during this imitation.

REEF KNOT

- **Other names:** Square knot, opposite knot.
- **Uses:** Joining two ropes of equal thickness. Also used in first aid for tying bandages.
- **Qualities:** Lies flat, holds well, and is easily untied.



The instructor shall provide an EXPLANATION and DEMONSTRATION of the complete skill. The instructor shall also provide an EXPLANATION and DEMONSTRATION of each step required to effectively complete the skill.

Procedure:

1. Take the running ends of two different ropes and place the left-hand working end across the right working end (Diagram 3, Figure 1).
2. Tuck the left-hand end under, and back up over the right end (Diagram 3, Figure 2).
3. Bring the two ends together again and place the right-hand end over the left-hand one (Diagram 3, Figure 3).
4. Tuck the right-hand end under and back up over the left-hand end (Diagram 3, Figure 4).
5. Dress the knot by pulling on both ends (Diagram 3, Figure 5).

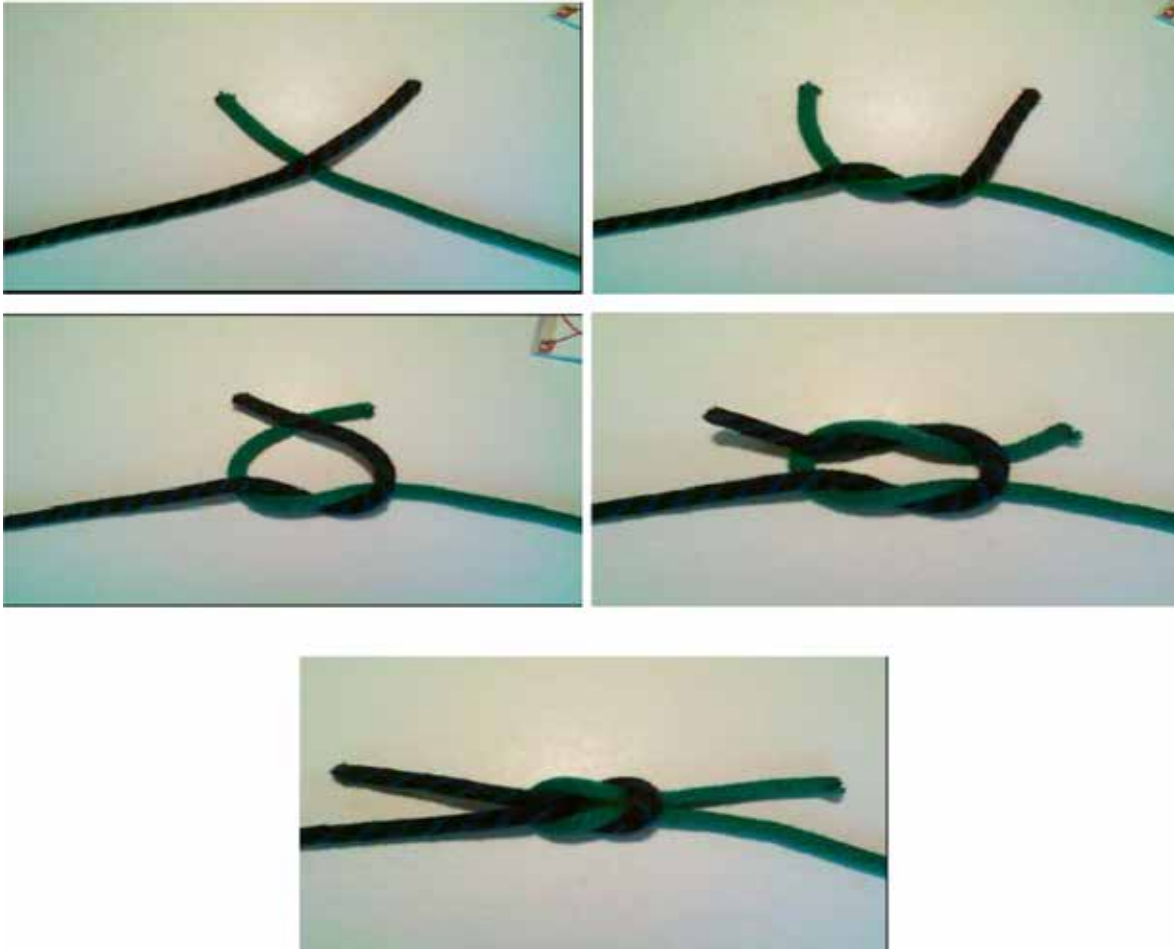

Figure 3 Reef Knot



When done correctly, the running end and the standing end of one rope are on the same side of the bight formed by the other rope. To tie this knot, a good trick is to say "left over right and right over left."



Cadets will IMITATE the demonstration provided by the instructor for each step within the skill. The instructor(s) will SUPERVISE the cadets during this imitation.

FIGURE OF EIGHT KNOT

- **Uses:** Keep the end of a rope from unravelling or to stop a rope from passing through an eye.
- **Qualities:** Same uses as the thumb knot but bulkier and easier to undo.



The instructor shall provide an EXPLANATION and DEMONSTRATION of the complete skill. The instructor shall also provide an EXPLANATION and DEMONSTRATION of each step required to effectively complete the skill.

Procedure:

1. Start by forming a loop with the running end passing under the standing end, and then make a bight in the running end (Diagram 1, Figure 4).
2. Pass the running end in front of the standing end then thread it through the loop from the back (Diagram 2, Figure 4).
3. The knot should now have the figure eight, which gives it its name (Diagram 3, Figure 4).

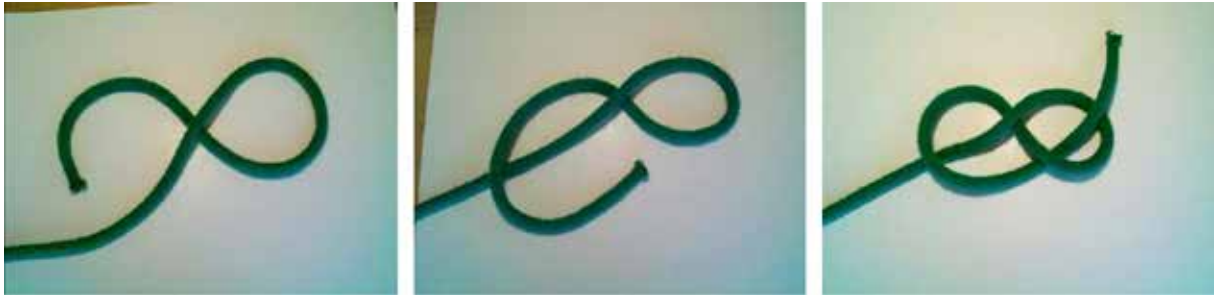

Figure 4 Figure of Eight Knot



Cadets will IMITATE the demonstration provided by the instructor for each step within the skill. The instructor(s) will SUPERVISE the cadets during this imitation.

DOUBLE FIGURE OF EIGHT

- **Other name:** Figure-of-eight loop.
- **Uses:** To anchor a rope around a tree trunk, pole or such item.
- **Qualities:** Will not slip and is easy to undo.



The instructor shall provide an EXPLANATION and DEMONSTRATION of the complete skill.

The instructor shall also provide an EXPLANATION and DEMONSTRATION of each step required to effectively complete the skill.

Procedure: There are two methods to do this knot. However, the first one is the one to use to anchor the rope to a tall tree or wide pole or trunk (Diagram 5).

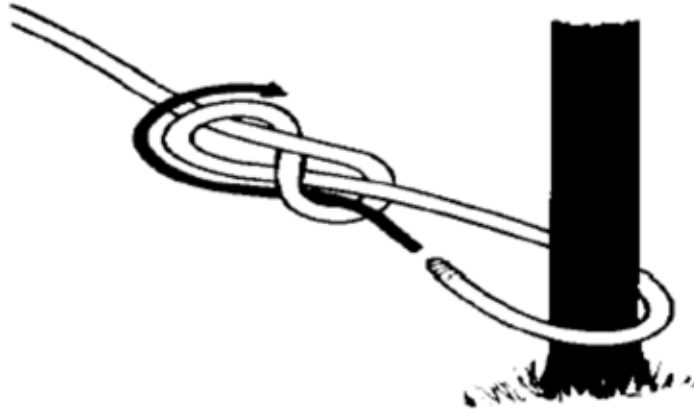

Army Cadet Reference Handbook

Figure 5 Double Figure of Eight Knot

The steps for method #1 are:

1. Begin with a loose figure of eight knot (Diagram 6, Figure 1).
2. Guide the running end back up through the loop it just came down through (Diagram 6, Figure 2).
3. Have the running end trace alongside the rope in the original figure of eight under the standing end.
4. Have the running end follow the original figure of eight under the double rope (Diagram 6, Figure 3).
5. The running end follows the original figure of eight (Diagram 6, Figure 4).
6. Pull tight and dress knot by flattening it and making sure the ropes are side by side.

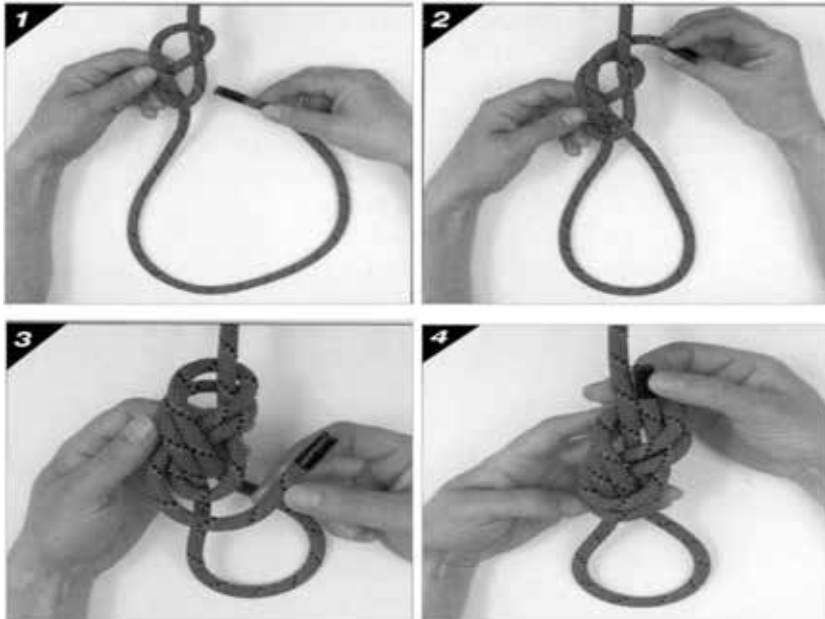

Pocket Guide to Knots and Splices, by Des Pawson, 1991

Figure 6 Double Figure of Eight Knot, Method #1

The steps for method #2 are: double the rope and follow the steps to make a figure of eight knot. (See Diagram 7.)



Pocket Guide to Knots and Splices, by Des Pawson, 1991

Figure 7 Double Figure of Eight Knot, Method #2



Cadets will IMITATE the demonstration provided by the instructor for each step within the skill. The instructor(s) will SUPERVISE the cadets during this imitation.

CLOVE HITCH

- **Uses:** To finish off knots like the round turn and two half hitches and the various types of lashings. To secure a rope to a spar, rail or similar fitting.
- **Qualities:** Quick and easy to tie. Can be made with the end or with the bight of the rope.



The instructor shall provide an EXPLANATION and DEMONSTRATION of the complete skill.

The instructor shall also provide an EXPLANATION and DEMONSTRATION of each step required to effectively complete the skill.

Procedure: There are two methods to tie a clove hitch; one using the end and the other using the bight.

The steps for tying a clove hitch using the end of the rope are:

1. Pass the running end of the rope over the rail from front towards the back.
2. Bring the running end under the rail and over the standing end towards the left.
3. Bring the running end over the spar to the left.
4. Bring the running end out under the rail and thread it up under the rope on the rail by the crossover.
5. Work the hitch tight with the running end and the standing end snug against each other.
6. Be sure to leave enough rope on the end so that it does not unravel.



Army Cadet Reference Handbook

Figure 8 Clove Hitch

The steps for tying a clove hitch using the bight are:

1. In the middle of the rope, make a crossing turn or half hitch, with the rope that comes from the left being on top.
2. To the right of the first crossing turn, make a half hitch with exactly the same configuration (Diagram 9, Figure 1).
3. Put the right-hand half hitch on top of the left-hand half hitch (Diagram 9, Figure 2).
4. The pair of hitches are now slipped over the top of the post (Diagram 9, Figure 3).

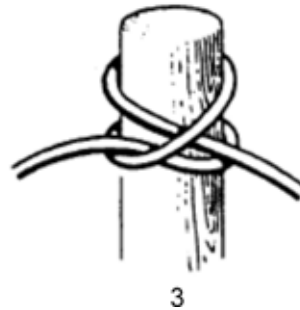
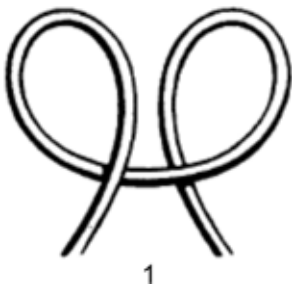

Army Cadet Reference Handbook

Figure 9 Clove Hitch



Cadets will IMITATE the demonstration provided by the instructor for each step within the skill. The instructor(s) will SUPERVISE the cadets during this imitation.

HALF HITCH

- **Uses:** Make other knots stronger. Hang, tie or hook objects.
- **Quality:** Easy to make.
- **Fault:** Cannot support a lot of strain.



The instructor shall provide an EXPLANATION and DEMONSTRATION of the complete skill.
The instructor shall also provide an EXPLANATION and DEMONSTRATION of each step required to effectively complete the skill.

Procedure: Pass the rope around the pole and then behind the standing part and into the eye of the loop.



Army Cadet Reference Handbook

Figure 10 Half Hitch



Cadets will IMITATE the demonstration provided by the instructor for each step within the skill. The instructor(s) will SUPERVISE the cadets during this imitation.



Give cadets handout B on knots, hitches, and lashings.

CONFIRMATION OF TEACHING POINT 3

QUESTION:

- Q1. What is the fault of the half hitch?
- Q2. Which knot will be used to anchor a rope to a tree trunk?
- Q3. What are the two types of fibre that can be used to make ropes?

ANTICIPATED ANSWERS:

- A1. Cannot support a lot of strain.
- A2. Double figure of eight knot.
- A3. Natural and synthetic fibres.

END OF LESSON CONFIRMATION

Cadets are to tie all knots, hitches and lashings learned in this EO.

CONCLUSION

HOMEWORK/READING/PRACTICE

Nil.

METHOD OF EVALUATION

Nil.

CLOSING STATEMENT

Knots, hitches and lashings have many uses in the field and will prove necessary in various situations, such as erecting a shelter, building a bivouac site or constructing a rope bridge. It is therefore important to know how to tie the knots properly, as well as when and where they should be used.

INSTRUCTOR NOTES/REMARKS

Where possible, the instructor should demonstrate a variety of natural and synthetic types of ropes.

Cadets should be given the opportunity to tie knots during the bivouac FTX

REFERENCES

A0-004 B-GN-181-105/FP-E00 DMPPD 9-4. (1997). *CFCD 105 fleet seamanship rigging and procedures manual*. Ottawa ON: The Department of National Defence.

C2-007 0-7858-1446-9 Pawson, D. (2001). *Pocket guide to knots and splices*. Edison, NJ: Chartwell Books, Inc.

Bight	Middle part of a length of rope. This term also refers to a loop of rope that does not cross over itself.
Chafe	Wear caused by abrasion.
Coil	Rope made up in neat series of circles usually for storage purposes.
Cordage	General term to cover all sorts and sizes of rope.
Crossing turn	A circle of rope made with the rope crossing over itself.
Eye	The hole inside a circle of rope; a permanent loop made at the end of a rope.
Mildew	Any fungus that attacks ropes when exposed to damp, resulting in a thin, furry, whitish coating or discoloration.
Standing end	The end of the rope not immediately being used in the tying of a knot.
Standing part	Part of the rope that usually “stands still” during the knot tying process. Often it is the longer end that leads away from the loop, bight or knot.
To tar	To cover a rope with a thick, sticky, brown to black liquid with a pungent odor, obtained by the destructive distillation of wood, coal, peat, shale, etc., to extend its life.
Working end	The very end of the rope that is used during the tying of the knot. Also called “running end.”
Working part	The short length of rope that is manipulated to make the knot. Also called “running part.”

THIS PAGE INTENTIONALLY LEFT BLANK

EO M 121.03 – KNOTS, HITCHES, LASHINGS

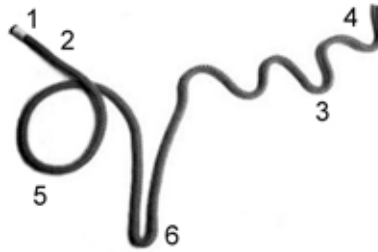

Pocket Guide to Knots and Splices, by Des Pawson, 1991

Figure B-1 Parts of a Rope

1. Working end (running end) – The end of the rope that is used during the tying of the knot.
2. Working part (running part) – The short length of rope that is manipulated to make the knot.
3. Standing part – Part of the rope that usually “stands still” during the knot tying process. Often it is the longer end that leads away from the loop, bight or knot.
4. Standing end – The end of the rope not immediately being used in the tying of a knot.
5. Loop (crossing turn) – A circle created in the process of tying a knot.
6. Bight – Middle part of a length of rope. This term also refers to a loop of rope that does not cross over itself.



These web pages have some excellent animated knots.

<http://www.mistral.co.uk/42brghtn/knots/42ktmenu.html>

<http://www.korpegard.se>

THUMB KNOT

- **Other names:** Overhand knot, Simple knot.
- **Uses:** Keep the end of a rope from unravelling or to stop a rope from passing through an eye.
- **Qualities:** Easy to make, stays in place.
- **Faults:** It is difficult to untie. An overhand knot in the middle of a length of rope will reduce the strength of the rope by about half.
- **Procedure:**
 - (1) Form a loop with the working end passing under the standing part of the rope (Figure B-2, image 1).
 - (2) Tuck the working end down through the middle of the loop formed by the crossing turn and out of the loop (Figure B-2, image 2).
 - (3) Pull both ends to tighten the knot. As it is being tightened the position of the knot can be moved nearer the end if so required (Figure B-2, image 3).

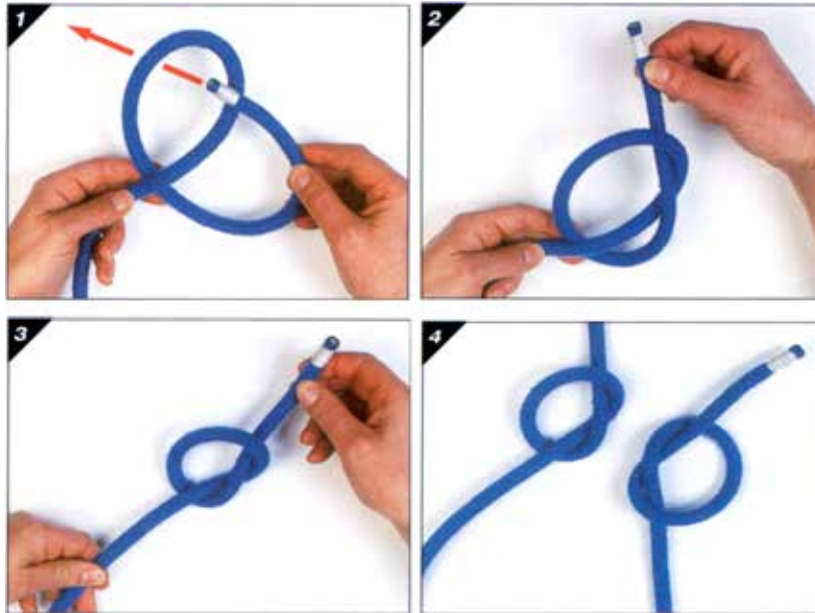

Pocket Guide to Knots and Splices, by Des Pawson, 1991

Figure B-2 Thumb Knot

REEF KNOT

- **Other names:** Square knot, Opposite knot.
- **Uses:** Joining two ropes of equal thickness. Also used in first aid for tying bandages.
- **Qualities:** Lies flat, holds well and is easily untied.
- **Procedure:**
 - (1) Take the running ends of two different ropes and place the left-hand working end across the right working end (Diagram 3, Figure 1).
 - (2) Tuck the left-hand end under, and back up over the right end (Diagram 3, Figure 2).
 - (3) Bring the two ends together again and place the right-hand end over the left-hand end (Diagram 3, Figure 3).

- (4) Tuck the right-hand end under and back up over the left-hand end (Diagram 3, Figure 4).
- (5) Dress the knot by pulling on both ends (Diagram 3, Figure 5).

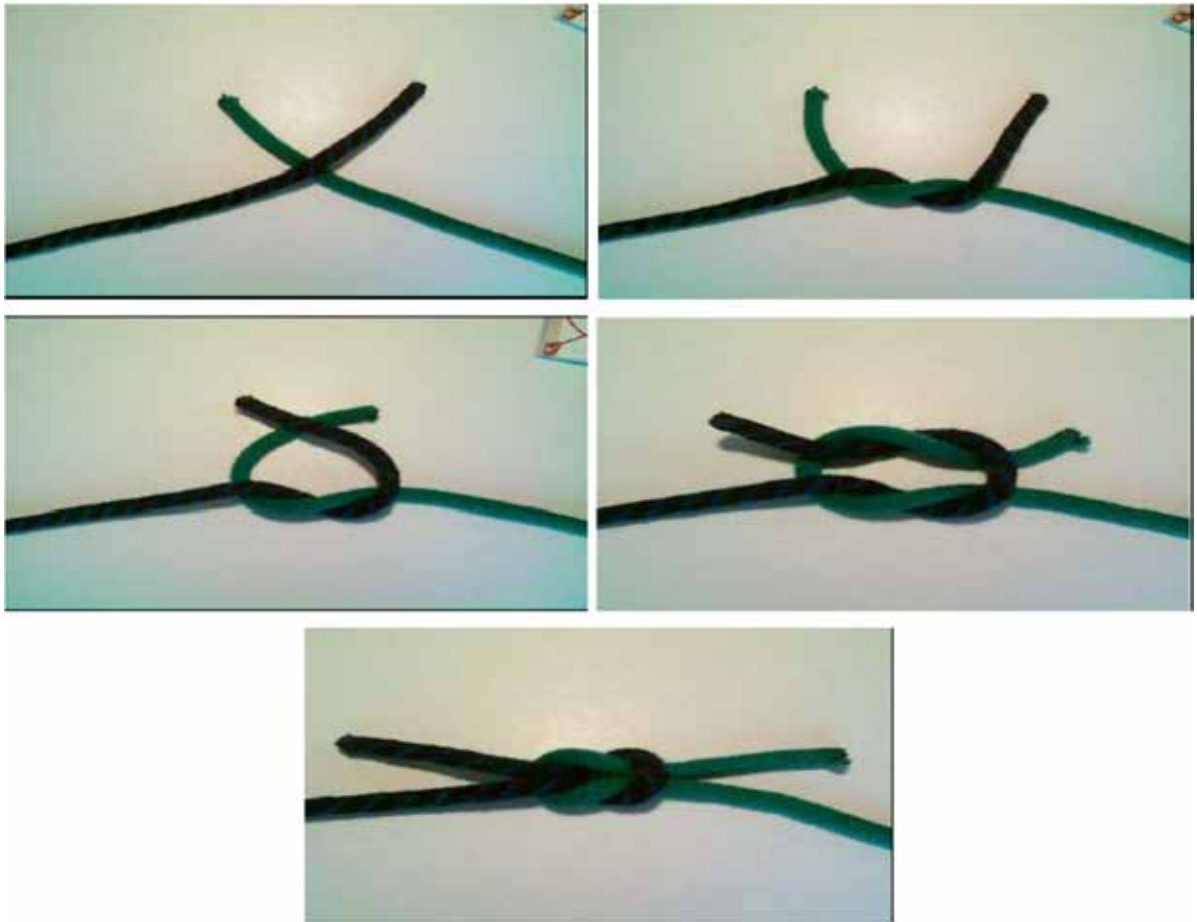

Figure B-3 Thumb Knot



When done right, the running end and the standing end of one rope come out on the same side of the bight formed by the other rope. To tie this knot, a good trick is to say “left over right and right over left.”

FIGURE OF EIGHT KNOT

- **Uses:** Keep the end of a rope from unravelling or to stop a rope from passing through an eye.
- **Qualities:** Same uses as the thumb knot but bulkier and easier to undo.
- **Procedure:**
 - (1) Start by forming a loop with the running end passing under the standing end, and then make a bight in the running end (Diagram 4, Figure 1).
 - (2) Pass the running end in front of the standing end then thread it through the loop from the back (Diagram 4, Figure 2).
 - (3) The knot should now have the figure eight, which gives it its name (Diagram 4, Figure 3).

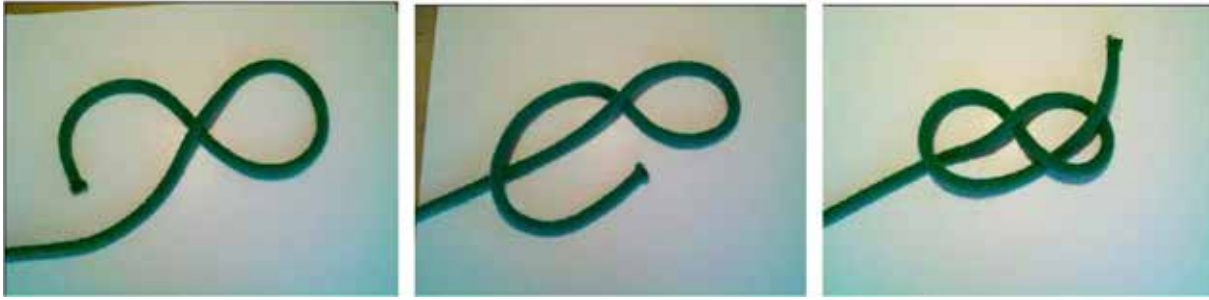

Figure B-4 Figure of Eight Knot

DOUBLE FIGURE OF EIGHT

- **Other name:** Figure-of-eight loop.
- **Uses:** To anchor a rope around a tree trunk, pole or such item.
- **Qualities:** Will not slip and is easy to undo.
- **Procedure:** There are two methods to do this knot. However, the first one is the one to use to anchor the rope to a tall or wide pole or trunk (Diagram 5).

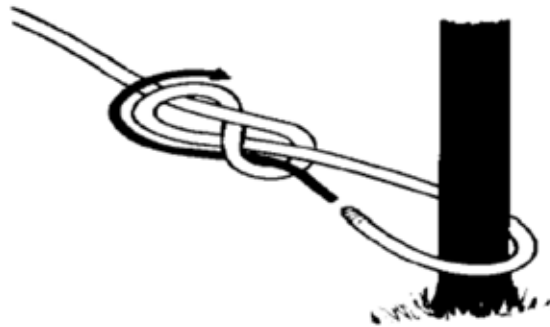
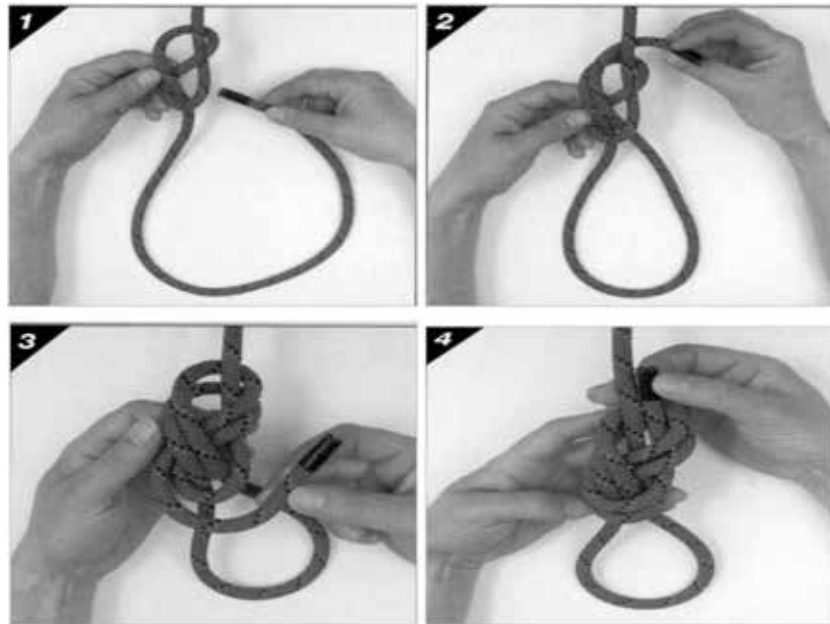

Figure B-5 Double Figure of Eight Knot

The steps for method #1 are:

1. Begin with a loose figure of eight knot (Diagram 6, Figure 1).
2. Guide the running end back up through the loop it just came down through (Diagram 6, Figure 2).
3. Have the running end trace alongside the rope in the original figure of eight under the standing end. Have the running end follow the original figure of eight under the double rope (Diagram 6, Figure 3).
4. The running end follows the original figure of eight (Diagram 6, Figure 4).
5. Pull tight, dress knot by flattening it and making sure the ropes are side by side.



Pocket Guide to Knots and Splices, by Des Pawson, 1991

Figure B-6 Double Figure of Eight Knot, Method #1

The steps for method #2 are double the rope and follow the steps to make a figure of eight knot. (See Figure B-7.)



Pocket Guide to Knots and Splices, by Des Pawson, 1991

Figure B-7 Double Figure of Eight Knot, Method #2

HALF HITCH

- **Uses:** Make other knots stronger. Hang, tie or hook objects.
- **Quality:** Easy to make.
- **Fault:** Cannot support a lot of strain.
- **Procedure:** Pass the rope around the pole and then behind the standing part and into the eye of the loop.



Army Cadet Reference Handbook

Figure B-8 Half Hitch

CLOVE HITCH

- **Uses:** To finish off knots like the round turn and two half hitches and the various types of lashings. To secure a rope to a spar, rail or similar fitting.
- **Qualities:** Quick and easy to tie. Can be made with the end or with the bight of the rope.
- **Procedure:** There are two methods to tie a clove hitch; one using the end and the other using the bight.

The steps for tying a clove hitch using the end of the rope are:

1. Pass the running end of rope over the rail from front towards the back.
2. Bring the running end under the rail and over the standing end towards the left.
3. Bring the running end over spar to the left.
4. Bring the running end out under the rail and thread it up under the rope on the rail by the crossover.
5. Work the hitch tight with the running end and the standing end sung against each other.
6. Be sure to leave enough rope on the end so that it does not unravel.



Army Cadet Reference Handbook

Figure B-9 Clove Hitch

The steps for tying a clove hitch using the bight are:

1. In the middle of the rope, make a crossing turn or half hitch, with the rope that comes from the left being on top (Diagram 14, Figure 1).
2. To the right of the first crossing turn, make a half hitch with exactly the same configuration (Diagram 14, Figure 2).
3. Put the right-hand half hitch on top of the left-hand half hitch (Diagram 14, Figure 3).
4. The pair of hitches are now slipped over the top of the post (Diagram 14, Figure 4).

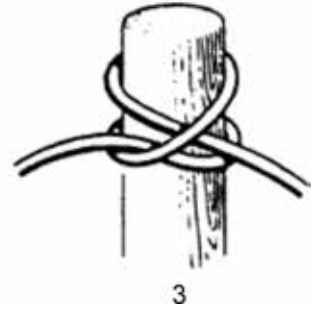
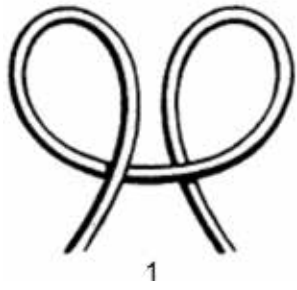

Figure B-10 Clove Hitch

THIS PAGE INTENTIONALLY LEFT BLANK



ROYAL CANADIAN ARMY CADETS
GREEN STAR
INSTRUCTIONAL GUIDE



SECTION 4
EO M121.04 – ASSEMBLE A SURVIVAL KIT

Total Time: 30 min

PREPARATION

PRE-LESSON INSTRUCTIONS

Resources needed for the delivery of this lesson are listed in the lesson specification located in A-CR-CCP-701/PG-001, *Green Star Qualification Standard and Plan*, Chapter 4. Specific uses for said resources are identified throughout the instructional guide within the TP for which they are required.

Review the lesson content and become familiar with the material prior to delivering the lesson.

PRE-LESSON ASSIGNMENT

Nil.

APPROACH

An interactive lecture was chosen for this lesson to orient the cadets to the content and the maintenance of a survival kit.

INTRODUCTION

REVIEW

QUESTIONS

- Q1. Backpacks can be divided into what two categories?
- Q2. Name five backpack features.
- Q3. Name the ABC's to packing.

ANTICIPATED ANSWERS

- A1. External and internal.
- A2. Any five of the following: Shoulder harness, chest strap, hip belt, inner and outer pockets, hydration system, splash cover, spindrift cover, bungee cords, and equipment straps.
- A3. **A**ccessibility, **B**alance, **C**ompactness.

OBJECTIVES

By the end of this lesson the cadet shall be expected to describe the contents and assembly of a survival kit.

IMPORTANCE

A survival kit, with appropriate contents, is essential to cadets that find themselves in survival situations. Cadets are required to be familiar with this subject, and shall be able to assemble a survival kit.

Teaching Point 1**Identify survival kit contents.**

Time: 15 min

Method: Interactive Lecture

SURVIVAL KIT CONTENTS

Everyone should carry a compact survival kit when travelling or working in the wilderness, as the items in a kit may save a life in an emergency. The survival kit should be carried in the pocket, as it is possible that a person may lose their pack (voluntarily or not) in an emergency.



Divide the cadets into equal groups of four to six people to develop a list of what they believe should be contained in a survival kit. They will have five minutes to develop the list.

ACTIVITYTime: 5 min

OBJECTIVE

- Recognize the contents of a survival kit.

RESOURCES

- Flipchart paper.
- Markers.
- Vivid imagination.

ACTIVITY LAYOUT

- The aim of the activity is to allow the cadets the opportunity to identify items that they would consider to be inside a survival kit prior to instruction of items in a survival kit.
- Activity instructions:
 - Introduce the lesson defining what a survival kit is, but not the contents thereof.
 - Divide the cadets into equal groups of four to six.
 - Provide groups with a sheet of flipchart paper and a few markers for recording.
 - Allow the cadets five minutes to determine what should be inside a survival kit.
 - Have the groups post their flipchart paper on the wall around the classroom.
 - At this point the instructor shall continue with the TP1 detailing the contents of a survival kit.
 - The goal is for the cadets to gain an understanding of what items are possible for a survival kit.

SAFETY

This is to be a supervised activity.

INSTRUCTOR GUIDELINES

Supervise the cadets giving assistance and clues if required.



The instructor is to have the cadets post their lists at the front of the classroom. The instructor shall then present the teaching point by comparing the lists developed by the cadets against the list provided below. The instructor shall highlight those that appear on both, explaining each component as it is presented.

The items from the list below that do not appear on a cadet list will be presented and explained following the comparative activity.

CONTENTS OF A SURVIVAL KIT

The contents of a survival kit should be specific to the activity being undertaken and the conditions in which that activity will take place. The contents could include items such as:

- **Candle.** Invaluable for starting a fire as well as using as a light source. Shave square for packing. If made of tallow it is also fat to eat in an emergency, or to use for frying – but be sure it is tallow; paraffin wax and some other candles are inedible. Tallow does not store well, especially in hot climates.
- **Compass.** A luminous button compass. Some small compasses can be confusing. Cadets should ensure they know how to read it before going into the field. A liquid filled type is best, but checks should be done to ensure that it does not leak, has no bubbles, and is fully serviceable. The pointer is prone to rust. Cadets should ensure that it is on its pivot and swings freely.
- **Fishhooks and Line.** A selection of different hooks in a small tin or packet. A few split lead weights should be added to the hooks. Remember that a small hook will catch both large and small fish but a large hook will only catch big ones. As much line as possible should be included, as it will also be useful for catching birds.
- **Flexible Wire Saw.** These usually come with large rings at the ends as handles. These take up too much room and should be removed; wooden toggles can replace them when needed. To protect from rust and breakage cover it in a film of grease. Flexible saws can be used to cut large trees or branches.
- **Flint.** Will work when wet and it will continue to strike long after the matches run out. A processed flint with a saw striker works best in a survival situation.
- **Magnifying Glass.** Can start a fire from direct sunshine and is useful for searching for splinters and stings.
- **Matches.** Waterproof matches are useful, but bulkier than ordinary non-safety, strike anywhere matches. These ordinary matches can be made “shower-proof” by dipping the heads in melted candle wax. To save space, snap off half of each matchstick. It is easier to use matches than to make fire by other methods; matches should not be wasted, and only used when improvised methods fail.
- **Mini Light.** Can be used at night to navigate. One set of spare batteries should be included as well.
- **Needles and Thread.** Several needles, including at least one with a very large eye that can be threaded with coarse threads. Strong thread should be chosen and wrapped around the needles.
- **Pen and Paper.** Allows one to keep notes of injuries, leave a message etc.
- **Personal Medical Kit.** Pack medicines in airtight containers with cotton wool to prevent rattling. This should be a basic kit only, as each unit should be bringing a comprehensive first aid kit with them on exercise. Mention a few common items, such as:
 - **Band-aids.** Sterile bandage helps control or stop bleeding of a small wound.
 - **Mini First Aid Pocket Guide.** For any unknown treatments when in the field, reference the guide.
 - **Moleskin.** A sheeted adhesive tape developed especially for hands and feet. Made from highly breathable non-woven fabric with ability to stretch, conform and not sweat or bathe off. The protective nap helps reduce friction and reduce calluses, and is great for holding second skin dressing in place.

- **Second Skin.** Hydro-gel dressing helps protect against blisters, pressure and friction. Helps bring cooling relief to stings, bites, poison ivy and blisters.
- **Plastic Bags.** Two large orange garbage bags for shelter and signalling.
- **Signalling Mirror.** Will draw attention by reflecting sunlight, plastic mirrors two by three inches are sufficient (other items may include compass mirror, crystal watch or a piece of foil).
- **Snare Wire.** Preferably brass wire (60 to 90 cm [two to three feet] in length). This is used for snares, but could solve many survival problems (i.e., building tools, etc.).
- **Water Sterilizing Tablets.** For use where water is not safe to drink and boiling it is not an option.
- **Whistle.** A sound-signalling device. Effective to ward off animals and signal for help.



This list is not exhaustive and is designed to give cadets choice, keeping in mind different field settings. A handout listing all contents in the survival kit covered is found at Attachment A. It is the instructors' choice whether to distribute the handout here, or at the end of the lecture.

CONFIRMATION OF TEACHING POINT 1

QUESTIONS

- Q1. I can be used to signal an aeroplane. What am I?
- Q2. I can provide you food in the form of fish. What am I?

ANTICIPATED ANSWERS

- A1. Signal mirror.
- A2. Fish hook.

Teaching Point 2

Time: 5 min

Survival kit storage case.

Method: Interactive Lecture

The contents of a survival kit are very important. Maintaining these items and ensuring they stay dry and undamaged will require a storage vessel that is durable, waterproof, light weight. These containers may be:

Hard Plastic. Very durable, and waterproof. Try to find a case that seals once closed, may be found in any department store.

Soft Plastic. This material, depending on design, can be very durable. Tupperware most often comes with a sealable lid, and may be found in any department store.

Metal Container. Very durable, waterproof, and useful to boil water; however, may possibly rust if not a stainless steel type.

CONFIRMATION OF TEACHING POINT 2

QUESTIONS

- Q1. Where can most of these items be found?
- Q2. What is the purpose of a storage vessel for the survival kit?
- Q3. What characteristics should a storage container have?

ANTICIPATED ANSWERS

- A1. Department store.
- A2. Maintains all contents in one place securely in a durable, waterproof, lightweight container.
- A3. Durable, waterproof and lightweight.

Teaching Point 3

Discuss conducting regular maintenance checks on survival kit items.

Time: 5 min

Method: Interactive Lecture

A prepared, ready to go survival kit is always a handy item; however, as time goes by it is necessary to do regular maintenance checks on the items contained inside the survival kit. The cadet should be looking for the following:

Checking Expiry Dates. Some items contained inside the survival kit will have expiry dates associated with them. It is important to do a complete review of all items periodically to ensure currencies are maintained. Expired items can do more harm than good.

Replacing Worn or Damaged Items. Over time, many items may become worn from use or be damaged. Be sure to keep stocked, and resupply the survival kit.

Replacing Missing Items. The contents of a survival kit can become cumbersome. Be sure to maintain a record of all items, complete regular inventory of contents, and replace any items that are missing as soon as possible.

CONFIRMATION OF TEACHING POINT 3

QUESTIONS

- Q1. Why should one do periodic checks of a survival kit?
- Q2. What type of maintenance checks should be conducted?
- Q3. When should missing items be replaced?

ANTICIPATED ANSWERS

- A1. Ensure expiry dates are current; replace missing, damaged or worn items.
- A2. Checking expiry dates, replacing worn or damaged items, and replacing missing items.
- A3. As soon as possible.

END OF LESSON CONFIRMATION

SCENARIO:

You are going on a camping trip with friends for the weekend. You are in an area that you know well with good tree coverage, and near a water source. You can only bring five items from your survival kit. What are they?

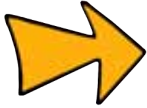

Divide the cadets into small groups (different than the previous time).

Have the cadets, as a group, decide on the five items they would take and why.

Have a representant from each group present the list to the rest of the group.

Once every group had a chance to present their lists, ask cadet to discuss if they would keep their original list or change it, based on other groups' lists.

ANTICIPATED ANSWERS

- Will depend on the group.

CONCLUSION

HOMEWORK/READING/PRACTICE

For additional study, a matching activity sheet has been provided for the cadets, found at Attachment B, along with an answer key. Attachment A contains a glossary of terms for all material presented in the survival kit.

METHOD OF EVALUATION

Nil.

CLOSING STATEMENT

The elements included in a survival kit could be essential to survival. The more that is included in the kit, the better the chances of survival.

INSTRUCTOR NOTES/REMARKS

This lesson should be delivered prior to the first time cadets enter the field.

Cadets will be required to prepare their own survival kit for the applicable field activity.

REFERENCES

C2-008 (ISBN 0-00-265314-7) Wiseman, J. (1999). *The SAS Survival Handbook*. Hammersmith, London: Harper Collins Publishers.

C2-010 (ISBN 0-375-70323-3) Rawlins, C., and Fletcher, C. (2004). *The Complete Walker IV*. New York, NY: Alfred A. Knopf.

THIS PAGE INTENTIONALLY LEFT BLANK

HANDOUT – EO M121.04 GLOSSARY

SURVIVAL KIT CONTENTS CHARACTERISTICS

- **Candle.** Invaluable for starting a fire as well as a light source. Shave square for packing. If made of tallow it is also fat to eat in an emergency or to use for frying – but be sure it is tallow; paraffin wax and some other candles are inedible. Tallow does not store well, especially in hot climates.
- **Compass.** A luminous button compass. Some small compasses can be confusing. Personnel should ensure they know how to read it before going into the field. A liquid filled type is best, but checks should be done to ensure that it does not leak, has no bubbles in it and is fully serviceable. The pointer is prone to rust. Personnel should ensure that it is on its pivot and swings freely.
- **Fishhooks and Line.** A selection of different hooks in a small tin or packet. A few split lead weights should be added to the hooks. Remember that a small hook will catch both large and small fish but a large hook will only catch big ones. As much line as possible should be included. It will also be useful for catching birds.
- **Flexible Wire Saw.** These usually come with large rings at the ends as handles. These take up too much room and should be removed; wooden toggles can replace them when needed. To protect from rust and breakage cover it in a film of grease. Flexible saws can be used to cut quite large trees or branches.
- **Flint.** Will work when wet and it will go on striking long after the matches run out. A processed flint with a saw striker works best in a survival situation.
- **Magnifying Glass.** Can start a fire from direct sunshine and is useful for searching for splinters and stings.
- **Matches.** Waterproof matches are useful but bulkier than ordinary non-safety, strike-anywhere matches, which can be made “shower-proof” by dipping the heads in melted candle wax. To save space, snap off half of each matchstick. It is easier to use matches than to make fire by other methods, matches should not be wasted and only used when improvised methods fail.
- **Mini Light.** Can be used at night to navigate. One set of spare batteries should be included as well.
- **Needles and Thread.** Several needles, including at least one with a very large eye that can be threaded with coarse threads. Strong thread should be chosen and wrapped it around the needles.
- **Pen and Paper.** Allows one to keep notes of injuries, leave a message etc.
- **Plastic Bags.** Two large orange garbage bags for shelter and signalling.
- **Signalling Mirror.** Will draw attention by reflecting sunlight, plastic mirrors two by three inches are sufficient (other items may include compass mirror, crystal watch or a piece of foil).
- **Snare Wire.** Preferably brass wire (60 to 90 cm [two to three feet] in length). This is used for snares, but could solve many survival problems (i.e. building tools, etc.).
- **Water Sterilizing Tablets.** For use where water is not safe to drink and boiling it is not an option.
- **Whistle.** A sound-signalling device. Effective to ward off animals and signal for help. Fox 40 whistle optimum.

MEDICAL KIT CHARACTERISTICS

- **Band-aids.** Sterile bandage helps control or stop bleeding of a small wound.
- **Mini First Aid Pocket Guide.** For any unknown treatments when in the field reference the guide.
- **Moleskin.** A sheeted adhesive tape developed especially for hands and feet. Made from highly breathable non-woven fabric with ability to stretch, conform and not sweat or bathe off. The protective nap helps reduce friction and reduce calluses and great for holding second skin dressing in place;
- **Second Skin.** Hydrogel dressing helps protect against blisters, pressure and friction. Helps bring cooling relief to stings, bites, poison ivy and blisters;

THIS PAGE INTENTIONALLY LEFT BLANK

SURVIVAL KIT CONTENTS MATCHING ACTIVITY

Matches	1 <input type="checkbox"/>	A. Will work when wet and it will go on striking long after the _____ runs out.
Candle	2 <input type="checkbox"/>	B. Several, including at least one with a very large eye that can be threaded with coarse threads. Strong thread should be chosen and wrapped around it.
Flint	3 <input type="checkbox"/>	C. A selection of different hooks in a small tin or packet. As much line as possible should be included.
Magnifying Glass	4 <input type="checkbox"/>	D. Illuminates the dark.
Needles and Thread	5 <input type="checkbox"/>	E. Can be used to cut quite large trees or branches.
Fishhooks and Line	6 <input type="checkbox"/>	F. The protective nap helps reduce friction and reduce calluses. Great for holding second skin dressing in place.
Compass	7 <input type="checkbox"/>	G. Can start a fire from direct sunshine and is useful for searching for splinters and stings.
Mini Light	8 <input type="checkbox"/>	H. Allows one to keep notes of injuries, leave a message etc.
Flexible Wire Saw	9 <input type="checkbox"/>	I. Invaluable for starting a fire as well as a light source. Shave square for packing.
Antihistamine	10 <input type="checkbox"/>	J. For use where water is not safe to drink and boiling it is not an option.
Whistle	11 <input type="checkbox"/>	K. Personnel should ensure they know how to read it before going into the field. A liquid filled type is best.
Pen and Paper	12 <input type="checkbox"/>	L. A sound-signalling device.
Moleskin	13 <input type="checkbox"/>	M. For allergies, insect bites and stings.
Water Sterilizing Tablets	14 <input type="checkbox"/>	N. Waterproof and are useful but bulkier than ordinary non-safety, strike-anywhere types.

SURVIVAL KIT CONTENTS MATCHING ACTIVITY

ANSWER KEY

SURVIVAL KIT	
Matches	1. N
Candle	2. I
Flint	3. A
Magnifying Glass	4. G
Needles and Thread	5. B
Fishhooks and Line	6. C
Compass	7. K
Mini Light	8. D
Flexible WIRE saw	9. E
Antihistamine	10. M
Whistle	11. O
Pen and Paper	12. H
Moleskin	13. F
Water Sterilizing Tablets	14. J



ROYAL CANADIAN ARMY CADETS
GREEN STAR
INSTRUCTIONAL GUIDE



SECTION 5

EO M121.05 – RECOGNIZE ENVIRONMENTAL HAZARDS

Total Time: 30 min

PREPARATION

PRE-LESSON INSTRUCTIONS

Resources needed for the delivery of this lesson are listed in the lesson specification located in A-CR-CCP-701/PG-001, *Green Star Qualification Standard and Plan*, Chapter 4. Specific uses for said resources are identified throughout the instructional guide within the TP for which they are required.

Review the lesson content and become familiar with the material prior to delivering the lesson.

PRE-LESSON ASSIGNMENT

Nil.

APPROACH

An interactive lecture was chosen for this lesson to introduce the cadets to environmental hazards.

INTRODUCTION

REVIEW

Nil.

OBJECTIVES

By the end of this lesson the cadet shall be expected to identify animal behaviour, hazardous insects, and hazardous plants, and identify possible strategies for dealing with them.

IMPORTANCE

When participating in an activity in the field, it is important to know how to recognize and deal with environmental hazards in order to remain safe at all times.

Teaching Point 1**Explain interpreting behaviour of wild animals.**

Time: 5 min

Method: Interactive Lecture

ANIMAL LANGUAGE

All animals use body language to give directions and indicate to one another when they are mad or glad, relaxed or hurt. They indicate where to find food, warn others of impending danger, or remind others who is leader. Through all kinds of subtle and overt mannerisms, communication is made, even in and around peers. There are four basic messages wildlife will give off via their body language: Contentment, Submission, Alarm and Aggression.

CONTENTMENT

Contentment is defined as a satisfied state; tranquil happiness. An animal that displays contentment is not threatened by one's presence and continues to go about its business of eating, sleeping, and moving from one place to another. This behaviour is displayed similarly by most species. A deer, for example, will frequently flick its tail and ears, walk slowly - with evenly spaced steps - and lower and raise its head in an alert fashion. When around wildlife displaying this behaviour it is likely the creature is aware of one's presence, but is not likely to become aggressive unless something is done to change the dynamic.

SUBMISSION

Submission is defined as giving way; yielding. This is an expression of social courtesy and submission to others that could be interpreted as a sign of alarm. When animals move past one another, like deer and coyotes, they often lower their heads and flatten their ears, or crouch and curl their tails between their legs. These signs of submission imply "hey, everything is cool", or "let's keep the peace". Similar postures show up in other animals from wolves to wild horses.

ALARM

Alarm is defined as a warning of danger. An animal that is alarmed is not relaxed, but is suddenly alert. When an animal picks up its ears and stares, it is showing alarm. Stress is created from being too close for comfort. When alarmed, an animal quickly stops feeding, may change direction, and if standing, it may move away or suddenly turn and face you.

Some animals have unique ways of expressing alarm; a beaver slaps its tail on the water, a deer "flags" its white tail and runs to safer ground. Skunks and rabbits beat their feet on the ground. The hair on coyote's backs goes up; they get stiffed legged, and they will tend to flatten their ears.

Alarmed animals issue warnings to others, including their kin. When witnessing these signs it is time to back off. An alarmed animal is under stress, and may become aggressive or flee their habitat when they feel these actions are critical to their survival.

AGGRESSION

Aggression is defined as the act or practice of attacking without provocation; an unprovoked attack. Sometimes, when one has failed to recognize the early warnings and has invaded an animal's space, the animal will stand its ground, becoming confrontational. Animals that become aggressive are generally protecting their young, food, or have been startled by a new presence.

To respond to such aggressive actions, one must use body language to diffuse the situation. Every move made can be interpreted as a reply. In most cases, stand tall and make yourself look big. Pick up a large stick and back away slowly. This will be interpreted by the animal to mean you are "too big to be messed with", and there is no desire to pick a fight.

CONFIRMATION OF TEACHING POINT 1

QUESTIONS

- Q1. What is the definition of contentment?
- Q2. What are the signs of submission from an animal?
- Q3. If you came upon a moose and it stood tall, looked straight at you and grunted furiously, what sign would be present?

ANTICIPATED ANSWERS

- A1. Contentment is defined as a satisfied state, tranquil happiness.
- A2. Animals often lower their heads and flatten their ears or crouch and curl their tails between their legs.
- A3. Aggression.

Teaching Point 2**Discuss hazardous insects.**

Time: 10 min

Method: Interactive Lecture

Biting and stinging insects are found everywhere in the wilderness. They are the most common hazard for the nature enthusiast. About 15 percent of people will react seriously to bee and wasp stings, and to insect bites. For them, an insect can produce a condition known as “anaphylactic shock,” where tissues swell extensively and can constrict the airway. Reactions can start with headaches, fever, and muscle spasms, and can develop into widespread hives, nausea, dizziness and difficult breathing.

Common insects, such as mosquitoes and ticks, carry many serious diseases such as West Nile virus, typhoid fever, dysentery, malaria and yellow fever. It is important to recognize the potentially dangerous insects, know which precautions to take, and immediate actions if stung.

SCORPIONS

Scorpions live in the grasslands found in southern Alberta and Saskatchewan and in the Okanagan Valley in British Columbia. The Canadian scorpion is a relatively innocuous variety called *Pararuroctonus Boreas*, which reaches one and a half inches in length. In Canada, scorpions are only active from May to September.

Only 25 species of scorpions are potentially lethal to humans, and ours is not one of them. Their sting is described as resembling that of a bee sting with a little pain and itching locally. If stung, apply a cold compress or immerse in cold water. Take an aspirin if necessary and see a physician if pain is prolonged.



http://people.uleth.ca/~dan.johnson/bws/dj_p_boreaus_cricket_400.png

Figure 1 Scorpion

11-M121.05-3

MOSQUITOES

Mosquitoes carry a lot of diseases with them. When they bite a human, it may cause reactions and make people sick. Swelling and fever may result from multiple bites.

Recent studies on mosquitoes show the following:

- Mosquitoes seem to be attracted to taller people and ones that are fidgety as they exhale more carbon dioxide, which attracts mosquitoes.
- They are attracted to wet clothing and even more to clothing with perspiration. They also prefer the colour blue.
- Mosquitoes can detect humans from as far away as six metres. They are attracted by heat, moisture and carbon dioxide. All of these factors are increased when moving a lot on a warm day.
- Upon biting, the mosquito injects saliva into the body to help extract the blood. This saliva causes the itching.

TICKS

Ticks can cause irritation and, in some cases, carry harmful germs. They are flat-bodied and round, with a small biting head that eats into a wound.



SAS Survival Guide, by John Wiseman, 1999

Figure 2 Tick

Hikers and walkers must check their legs daily for ticks embedded in the skin. If one is found, the following should be done:

1. use heat, oil, petroleum jelly, alcohol, nail polish or hot water to make the tick drop off. This will prevent the tick from breathing and it will release its hold immediately;
2. if the tick does not come off, leave the oil on for half an hour and use a pair of tweezers to remove it by pinching as close to the skin as possible, pulling gently. Do not use fingers to pull it out; and
3. wash the area with water and soap.

SPIDERS

Though most spiders are venomous and considered predators, of the thousands of species found in Canada, few are actually considered a health threat. In fact, spiders are actually helpful in controlling other pests in the home or garden since they feed on other insects and spiders. They generally bite and inject venom into their prey. Spiders however, rarely bite humans. The venom of most species is not very toxic to humans, usually resulting in no more than a slight swelling, inflammation, or itching sensation. In Canada, the two spiders that can be a health risk are the black widow and the brown recluse.

Black widow spider

Black widow spiders have a dark brown to glossy black body. However, the young black widows are white in colour. When their legs are extended, they have a size of 2.54 x 3.81 cm. The female is extremely poisonous. She has a red or yellow hourglass marking on the underside of the abdomen (see Figure 3). The male does not have this marking and is smaller.

Black widows are usually found outdoors in sheds, outhouses, under stones, logs, in hollow stumps, and sometimes indoors in dark corners of garages, rock walls, barns or woodpiles. Their web is distinctive. The strands of silk run in many directions so the web appears as a concentration of irregularly arranged threads. The silk strand of the web is considerably heavier and stronger than those of other species that form similarly shaped webs.

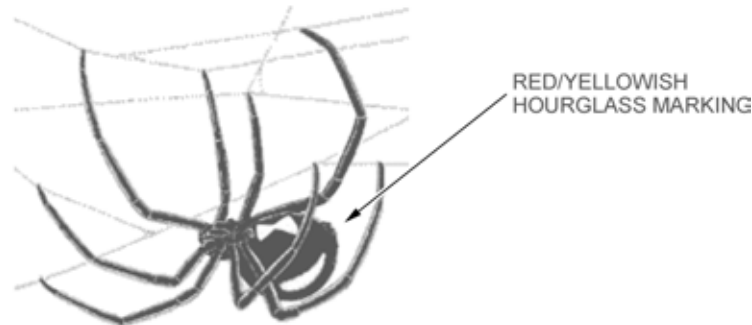

<http://desertmuseum.org>

Figure 3 Female Black Widow

The female black widows will bite when handled or accidentally touched. Their bites produce local redness with two tiny red spots, severe pain, sweating, shivering, nausea and weakness. The victim could even writhe in agony and have difficulty talking and breathing. It is rarely fatal, but can disable the victim for up to a week. The venom's effect will occur in about 30 minutes and attacks the nervous system. Serum is needed to counteract the black widow's venom.

When travelling to the doctor's, keep the victim calm and apply an antiseptic to the sting area. Place an ice pack around the bite area to slow the spread of the venom.

Wearing leather gloves when working around potential black widow habitats will help avoid getting bitten.

BEES

Bees are a venomous, stinging, social insect that are abundant in urban areas. When nests are disturbed, bees will get defensive and can inflict multiple stings.

Honeybees are less aggressive, as they live in well-protected hollow trees and other cavities. They do not have to protect their nests, so they do not have to be aggressive and sting as frequently to protect their home. This type of bee stings only once, as the barbed stinger will stay embedded in the skin. The stinger embedded in the skin must be removed as soon as possible as the venom sac will continue to pump for two to three minutes driving the venom deeper into the skin. The best way to remove the stinger is to scrape it out with a fingernail, as this will avoid squeezing the venom sac.

African bees make nests in the openings of tree branches and in holes in the ground. Their nests are vulnerable to attack and they have to fight potential predators. For this reason, they are easily provoked and highly defensive. They respond more quickly, stay agitated longer, and chase enemies further, than European bees. The sting of a single African bee is no more dangerous than the one of other honey bees but the massive attack of hundreds of bees and hundreds of stings can prove fatal. African bees are sometimes referred to as "killer bees."

African bees look like other honeybees but they are slightly smaller, weigh less, and have shorter stingers and forewings. They are more nervous in their hives, and fly farther and in a more zigzag pattern than European bees.

WASPS

There are several varieties of wasps in North America, including the yellow jacket, hornet and paper wasp. Colour ranges from black to combinations of black with yellow, white or brown markings. The slim winged body measures 10 to 19 mm. All wasps species have chewing mouthparts and the females possess a stinger.



www.abellgroup.com

Figure 4 Wasp

Nests can be found around buildings, on verandas, under eaves, ceilings, attics or in trees and shrubs. Several varieties of wasps build nests under ground. Wasps are very protective of their nest and, though they will use the nest for only one season, it can contain as many as 10 000 to 30 000 individuals.

As bees do, wasps inject venom under the skin. Wasps have smoother stingers than bees and so can sting numerous times. Their sting produces a few minutes of fierce burning, followed by redness and itching at the point of the sting. A welt may form and subside in three or four hours. A wasp sting, aside from being very painful, can prove serious and sometimes fatal.

If a wasp stings someone, the sting area must be washed with water and soap. If the stinger and venom sac remain in the wound, a fingernail or knife blade can be used to scrape them out. The sting area should be washed again.

AVOIDING INSECTS

Most insects are a nuisance rather than a danger. When bothered by insects like mosquitoes, black flies, deer flies, or chiggers, hikers have several options available to thwart such nuisances, and reduce exposure by controlling their surroundings. Try and avoid camping areas with tall grass, weeds and standing water where insects are abundant.

Preventive measures to avoid insects:

Clothing and Scents

- Avoid wearing brightly coloured clothing as it will attract insects. Wear pale colour clothing and fabrics.
- Cover up as much of the body as possible.
- Limit the use of fragrances (i.e., colognes, perfumes, deodorant, shampoos, etc.), as insects are attracted to them. Use fragrance-free soap and detergent.

Insect Repellents

Apply insect repellents such to ward off unwanted insects. These repellents should be applied to the exposed areas of the body. Many insect repellents rely on chemicals to repel insects and have effective durations per application.

Product effectiveness:

- **DEET:** Protects from bites for a period of two to six hours. Generally, the higher the concentration of DEET the longer the protection; however, use of a produce with more than 30 percent DEET is unlikely to yield any benefit.
- **P-Methane 3,8 Diol:** Provides up to two hours of protection. Not to be used by children under three years of age.
- **Soybean Oil:** Provides between one and three and one half hours of protection.

WARNING

DEET in high concentrations can be harmful to a person's health, specifically the nervous system.

NOTE

Health Canada recommends:

- Children under six months are NOT to use insect repellents containing DEET.
- Children aged six months to two years are NOT to use insect repellents containing DEET.
- Children between 2 to 12 years: Apply no more than three times a day using the lowest concentration of DEET (10 percent or less).
- Individuals 12 years or older: Apply insect repellents containing no more than 30 percent DEET.

CONFIRMATION OF TEACHING POINT 2

QUESTIONS

- Q1. Why is it important to be protected against insects?
- Q2. What can be used to remove ticks from skin?
- Q3. How can the female black widow be recognized?
- Q4. What is the remedy for a black widow bite?
- Q5. What marking makes the brown recluse spider stand out amongst other spiders?
- Q6. What precautions can be taken in order to prevent being bitten by a brown recluse?
- Q7. What percentage of DEET can cadets use?

ANTICIPATED ANSWERS

- A1. Some people will react seriously to stings and bites. Insects can also carry serious diseases.
- A2. Heat, oil, petroleum jelly, alcohol, nail polish, hot water.
- A3. She has a red or yellow hourglass marking on the underside of the abdomen.
- A4. Serum (anti-venom).
- A5. It has a distinctive fiddle-shaped mark on its back.
- A6. Shake out unworn or stored shoes and clothes before wearing. Check bed linens of unoccupied beds. Wear leather gloves when working around potential habitats.

- A7. 12 years old, apply no more than three times a day using the lowest concentration of DEET (10 percent or less). Individuals 12 years or older, apply insect repellents containing no more than 30 percent DEET.

Teaching Point 3

Explain how to identify poisonous plants.

Time: 10 min

Method: Interactive Lecture

POISON IVY

Poison ivy is present in every province except Newfoundland and Labrador, and occurs on sandy, stony, or rocky shores of streams, rivers and lakes. It sprouts in thickets, along the borders of woods and in wood openings.

Characteristics

- glossy plant;
- grows as a:
 - trailing vine, a sub-shrub 5 to 120 cm high; and
 - aerial-rooted vine that climbs rough surfaces to 15 m;
- leaves consist of three leaflets with the middle one having a stalk longer than the other two; and



SPRING AND SUMMER

FALL

www.cwss-scm.ca/weeds/images/F22_centralPoisonIvy.jpg

Figure 5 Poison Ivy

- leaves alternate in colour and are reddish in the spring, green in the summer and are various shades of red, yellow, orange or bronze in fall.

POISON SUMAC

Poison sumac is found in some of the wooded swamps of southern Ontario and southern Quebec. It is a tall shrub or small tree with 6 to 12 leaflets arranged in pairs and an additional single leaflet at the end. The small yellowish green flowers, born in clusters, mature into whitish-green fruits that hang in loose clusters 10 to 30 m in length.



http://res2.agr.gc.ca/ecorc/poison/vernix_e.htm

Figure 6 Poison Sumac



http://res2.agr.gc.ca/ecorc/poison/vernix_e.htm

Figure 7 Poison Sumac



http://res2.agr.gc.ca/ecorc/poison/vernix_e.htm

Figure 8 Poison Sumac With White Berries

POISON OAK

Poison oak is found only in western Canada. It grows as a bush, vine root and shrub-like forms, It has leaves divided into three leaflets that are roughly edged and densely haired. The white berry-like fruits are also haired. Poison oak continually changes colours corresponding with the seasons; red in spring, green in summer and red/bronze in the fall.



www.knowledge.org/oak/identify.html

Figure 9 Poison Oak



www.odsu.com/images/poioak1b.jpg

Figure 10 Poison Oak



www.coloma.com/reference/401-1-18-poisonoak.jpg

Figure 11 Poison Oak

Infected Symptoms

The symptoms of the allergic reaction to exposure to poison ivy, sumac, and oak are similar, they are:

- severe itching of the skin;
- red inflammation and blistering of the skin; and
- in severe cases, oozing blisters develop.

Wash infected skin as soon as possible with cold water to minimize severity of the rash and prevent the spread of the sap to uninfected parts of the body. Although extremely irritating, most cases disappear within a week to 10 days. Relief may be found through the application of medication such as calamine lotion, which is available in most drug stores.



Poison Ivy is treatable with a natural herbal remedy. When in the field and you have been exposed to poison ivy, oak, or sumac, locate a plant called jewelweed (preferable orange jewelweed not yellow). To apply jewelweed as a remedy, slice the stem then rub its juicy inside on exposed parts, this will promptly ease irritation and usually prevents breakouts.



www.westol.com/~banding/jewelweed-090602.jpg

Figure 12 Orange Jewelweed



www.donwiss.com/pictures/F-2001-07-0410019.jpg

Figure 13 Jewelweed



www.naturealmanac.com/natural_events/f/jewelweed.jpg

Figure 14 Orange Jewelweed

CONFIRMATION OF TEACHING POINT 3

QUESTIONS

- Q1. What three poison plants are found in Canada?
- Q2. What are the symptoms that a person has come into contact with a poisonous plant?
- Q3. What is the name of the plant that can be used as an herbal remedy to treat an exposed person?

ANTICIPATED ANSWERS

- A1. Poison ivy, poison oak, and poison sumac.
- A2. Severe itching of the skin, red inflammation and blistering of the skin. In severe cases, oozing blisters develop.
- A3. Jewelweed.

END OF LESSON CONFIRMATION

QUESTIONS

- Q1. Why is it important to be protected against insects?
- Q2. What can be used to remove ticks from skin?
- Q3. How can the female black widow be recognized?
- Q4. What three poisons plants are found in Canada?
- Q5. What are the symptoms that a person has come into contact with a poisonous plant?

ANTICIPATED ANSWERS

- A1. Because some people will react seriously to stings and bites. Insects can carry serious diseases.
- A2. Heat, oil, petroleum jelly, alcohol, nail polish and hot water.
- A3. She has a red or yellow hourglass marking on the underside of the abdomen.
- A4. Poison ivy, poison oak, and poison sumac.
- A5. Severe itching of the skin, Red inflammation and blistering of the skin. In severe cases, oozing blisters develop.

CONCLUSION

HOMEWORK/READING/PRACTICE

Nil.

METHOD OF EVALUATION

Nil.

CLOSING STATEMENT

It is important for everyone who participates in field training to know how to recognize and deal with dangerous animals, insects, and poisonous plants, in order to ensure the safety of all participants.

INSTRUCTOR NOTES/REMARKS

This lesson should be delivered prior to the bivouac exercise.

REFERENCES

C2-004 (ISBN 1-896713-00-9) Tawrell, P. (1996). *Camping and Wilderness Survival: The Ultimate Outdoors Book*. Green Valley, ON: Paul Tawrell.

C2-008 (ISBN 0-00-265314-7) Wiseman, J. (1999). *The SAS Survival Handbook*. Hammersmith, London: Harper Collins Publishers.

C2-032 Curtis, S. (1998, September). *Watch your Language*. Retrieved 25 May 2006, from http://www.backpacker.com/article/1,2646,135_article,00.html.



ROYAL CANADIAN ARMY CADETS
GREEN STAR
INSTRUCTIONAL GUIDE



SECTION 6

EO M121.06 – IDENTIFY ENVIRONMENTAL INJURIES

Total Time: 30 min

PREPARATION

PRE-LESSON INSTRUCTIONS

Resources needed for the delivery of this lesson are listed in the lesson specification located in A-CR-CCP-701/PG-001, *Green Star Qualification Standard and Plan*, Chapter 4. Specific uses for said resources are identified throughout the instructional guide within the TP for which they are required.

Review the lesson content and become familiar with the material prior to delivering the lesson.

PRE-LESSON ASSIGNMENT

Nil.

APPROACH

An interactive lecture was chosen for this lesson to introduce the cadets to environmental injuries.

INTRODUCTION

REVIEW

Nil.

OBJECTIVES

By the end of the lesson the cadet shall be expected to recognize the effects that hot and cold weather may have on the body, and how to identify and prevent environmental injuries.

IMPORTANCE

Cadets need to know how to recognize hot-and-cold weather dangers and treatment of these effects. Knowing how to properly identify various hot-and-cold related injuries and take proper preventative measures will ensure a safe, fun and meaningful training experience in any weather conditions.

Teaching Point 1**Explain how to identify cold-related injuries.**

Time: 15 min

Method: Interactive Lecture

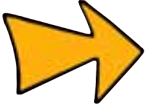

This teaching point contains substantial background information to be used by the instructor in the development of a lesson plan. During delivery, the emphasis shall be placed on the **preventative** measures detailed throughout. A detailed discussion of cold weather injuries is provided in EO C121.04 (Section 13).

FROSTBITE

Frostbite is the freezing of tissue in the body. As blood flow slows down, the fluid between cells can freeze. As ice crystals form on them, the cells become dehydrated. Frostbite acts locally on parts of the body such as fingers, toes, chin, nose and ears. It is a constant hazard during activities occurring in sub-zero temperatures, especially when accompanied by strong winds.

Signs and symptoms of frostbite stages:

Surface Frostbite. Also known as superficial frostbite or frostnip, it affects only the skin and causes little damage. Only the outer layer of the skin is frozen. It may occur from contact with cold metal or severe wind chill. After the nipped area is warmed, the layer of frozen skin becomes red, and after a few days, the skin will peel, looking similar to sunburn. Signs and symptoms include:

- skin turns white and numb;
- tissues beneath the affected area are still soft;
- casualty may not feel it; and
- may notice white spot.

Deep Frostbite. Frostnip has progressed into underlying tissue. It may feel hard on the surface, and soft below. Blisters will usually appear within 24 hours of warming. It needs proper warming, not just an application of heat. If it progresses even further, the injury extends into deeper tissue and into the muscle. Blisters containing fluid, blood-filled blisters, delayed blisters or lack of blisters forming within 48 hours of warming indicate deep frostbite. It may cause loss of tissue and permanent damage, including the loss of parts, or all of the affected area. Proper field care can often mean the difference between temporary disabilities and permanent injuries.

Signs and symptoms include:

- pain or numbness in the fingers, toes, heels, and entire hands and feet;
- tissue is hard all around the affected area;
- the frostbitten part is cold and white (sometimes purple); and
- no pain, or feeling of any kind, in the extremity that is frozen.

Prevention

Surface. Is common on the face and is associated with naturally occurring wind, or wind from a moving vehicle. A good parka tunnel will usually prevent frostbite because it holds a pocket of warm air around the face. In strong winds, cover the nose and cheeks with a face mask, scarf, or any piece of warm fabric. Since frostbite is often not felt, the first warning may come from a companion who notices a white spot on your face. Frostbite is also common on the hands if doing work, or if coming into direct contact with cold metal.

Deep. Often occurs when exposed to freezing temperatures with no chance to warm-up, or when hands and feet become wet and freeze. It is important to eat often to maintain body warmth, drink often to avoid dehydration, and rest enough to avoid fatigue while restoring circulation. Warm numb and painful feet immediately.

Treatment

Do not use snow, oil, rubbing, massage or pressure.

Surface. Serves as a warning. A frozen nose is the most common type of surface frostbite. Most minor frostbite can usually be thawed with body heat. Place a warm palm against a frostbitten cheek or ear, and place frostbitten hands against your chest, between your thighs, or under your armpits. Surface frostbite that produces blisters may require the casualty to be evacuated for medical attention.

Deep. Remove all constricting clothing such as boots, gloves or socks, without causing further damage to the frostbitten area. The frozen part should be placed against an unfrozen part of the body or exposed to warm air. Rapid thawing by the application of external heat is the safest way to relieve frostbite. Clean and dress the area to avoid infection. Do not exercise the injured person, or warm them in front of an open fire. Seek immediate medical attention.

SIGNS AND SYMPTOMS OF HYPOTHERMIA

Cold exposure, or hypothermia, is the drop of the vital core temperature of the body. Exposure can be divided into three levels – mild, moderate and severe. It is hard to tell where one level starts and the next stops without a special thermometer.

Signs and symptoms of hypothermia stages:

Mild Exposure. During mild exposure the casualty:

- is awake;
- shivering;
- can answer questions intelligently;
- may be slurring their speech;
- is losing interest in what they are doing; and
- is complaining that they are cold.

Moderate Exposure. During moderate exposure the casualty:

- is confused and illogical;
- does not want to move much, and may be sleepy;
- is clumsy and stumbles;
- stops shivering;
- shows signs of muscle stiffness;
- has slow breath and pulse rates;
- may have a fruity odour to their breath;
- may have dilated pupils; and
- may urinate in clothing.

The casualty is in great danger and is close to severe hypothermia, unconsciousness and death.

Severe Exposure. Moderate exposure quickly becomes severe exposure. At this point the casualty is in a coma, and is close to death. In severe exposure, the casualty:

- is barely conscious;
- has slow, shallow breathing and a weak, slow, irregular or absent pulse; and
- has pale, very cold, perhaps bluish skin.

During this time, the casualty will appear dead. It is important to remember that though they may look dead, there still may be a faint pulse, and some respiration. You can not determine if someone is dead until the body has warmed up and there is still no sign of life.

Prevention

There are a number of things a person can do to help prevent exposure:

- prepare for the worst and take extra clothing;
- avoid overheating and sweating. Wear loose, layered clothing that breathes. Cotton wets easily and dries slowly. Wool is warm, even when wet, and modern fabrics such as polypropylene and polyester are superior next to the skin;
- avoid long term cooling. Take breaks for hot drinks, and try to get out of the wind. Do not continue on if you are getting seriously cold;
- eat often to provide fuel for your body. Sugars and starches work most quickly;
- drink lots. Dehydration is a major contributor to exposure. Hot, sweet drinks are best, but you can also drink cold water. Do not eat snow if you are cold;
- keep your big muscles moving. This creates heat. Keep wiggling your toes and fingers if they are cold. Wiggling them will not warm you up too much, but moving the larger muscles of the arms and legs will. Swing your arms vigorously, and place the hands in the armpits; and
- check your companions often. If they get clumsy, start to shiver, slur their speech, or act strangely, you can suspect exposure. Remember that people suffering from exposure do not always feel it.

Treatments

Mild Exposure. If you think that your companion is suffering from mild exposure, you should:

- stop travelling;
- prevent any further loss of body heat;
- get them into shelter;
- replace any wet clothing;
- allow shivering to continue as it is the body trying to warm up; and
- give them food and hot drinks.

Rewarming with skin-to-skin contact or sleeping bags is the best way to help the person.

Moderate Exposure. If the casualty is suffering from moderate exposure, treat them for mild exposure, except:

- avoid rough handling and do not let them walk; and
- do not give fluids to drink until they are awake and understand what is going on. This will prevent choking.

Never handle anyone in moderate exposure roughly, or allow them to move much, as this affects the heart and can cause it to fail quickly.

Severe Exposure. There must be medical treatment at this time. There is some treatment that you can give to a casualty showing signs of severe exposure. They are:

If there is any breathing or a pulse, you should:

- handle the casualty very gently;
- prevent further heat loss; and
- move them gently to medical care.

If medical attention is not available, and you are far from help, you should:

- immediately and gently move them into warm shelter;
- apply heavily wrapped warm water bottles to sides of their neck, chest, and groin. Do not put them anywhere else; and
- keep them warm and let them recover very slowly without moving them.

It is very important that the water bottles be only slightly warm, as too much heat will damage the skin. Do not rub the hands, feet, or legs or move them if you do not have to. If the casualty recovers, the hearing is the first to return, then the sight. They may then lose control of their bowels.

CONFIRMATION OF TEACHING POINT 1

QUESTIONS

- Q1. What is the most common type of superficial frostbite?
- Q2. What are the three types of exposure?
- Q3. What are some things you can do to prevent exposure?

ANTICIPATED ANSWERS

- A1. A frozen nose.
- A2. Mild, moderate and severe.
- A3. Any of the following: take extra clothing, avoid sweating and long term cooling, eat often, drink lots, keep active, and check each other often.

Teaching Point 2

Explain how to identify heat-related injuries.

Time: 10 min

Method: Interactive Lecture

HEAT CRAMPS



The instructor shall present the following information, with emphasis being placed on the treatment and prevention of the various ailments. The instructor should remember, when planning the lesson, to emphasize the importance of notifying a supervisor or senior cadet of any signs or symptoms being noticed.

Heat cramps are caused by the loss of salt during excessive sweating, as a result of a failure of the natural cooling mechanisms in the body to control the body's temperature. This is a warning sign of heat exhaustion, and occurs in the muscles doing the most work, such as the arms, legs and abdomen.

Symptoms:

- Shallow breathing.
- Vomiting.
- Dizziness.

Treatment:

- Move to shade.
- Rest.
- Drink water with a little salt dissolved in it (only a pinch to a half litre).

HEAT EXHAUSTION

Heat exhaustion is caused by exposure to high temperatures and humidity, with loss of body fluids through excessive sweating. It can occur without direct exposure to the sun; just being in a hot building with poor ventilation may cause it.

Symptoms:

- Pale face.
- Cold sweaty skin.
- Weak pulse.
- Dizziness.
- Weakness and possible cramps.

Treatments:

- Move to shade.
- Rest.
- Drink water with a little salt dissolved in it (only a pinch to a half litre).

HEATSTROKE

Heatstroke is caused by the failure of the brain to regulate the heat mechanisms of the body, and will cause a cessation of sweating (cooling). Heatstroke can occur after a few hours of exposure to intense heat, but usually occurs after a few days of prolonged exposure (i.e. heat wave, or a holiday in the tropics). People from temperate climates who have not had a chance to acclimatize are at a higher risk of being affected. During strenuous activities and high temperatures the chances of heatstroke occurring are increased.

Symptoms:

- Hot dry skin.
- Flushed face and feverish (sweating stops).
- Rise in temperature.
- Pulse is rapid and strong.
- Severe headache, often with vomiting.
- Unconsciousness may follow.

Treatments:

- Lay in the shade with head and shoulders slightly raised.
- Remove outer clothing, cool body by wetting underclothing with TEPID water (cold water may push the core temperature up) and fanning.
- Spray or sprinkle water over casualty.
- Casualty should be placed in a cool damp area with plenty of ventilation.
- When consciousness returns give water to drink.
- When temperature returns to normal replace clothing, and keep warm to prevent chill.

SUNBURN

Sunburn occurs when skin is burned by exposure to the sun or ultraviolet light. The skin will burn when the amount of exposure to the sun or ultraviolet light source exceeds the ability of the body's protective pigment to protect the skin. The best prevention for sunburn is to remain covered as much as possible, and to apply sunscreen with a SPF rating of 29 or higher to exposed skin.

Sunburn in a very light skinned person may occur in less than 15 minutes of midday sun exposure, while a dark skinned person may tolerate the same exposure for hours. Actual sunburn, with blisters, is a real danger, especially with pale and sensitive skin types. If more than two thirds of the body is affected it can prove fatal.

Treatment:

- avoid further exposure;
- keep in the shade;
- cover all blisters with dressings (DO NOT BURST); and
- seek medical assistance.

SORE EYES

Sore eyes may be due to glare. This is more common when on a lake or ocean, in the desert, or on snow covered locations. It is caused by overexposure to the sun or dust particles.

Treatment:

- rest in the shade;
- cover eyes after washing out foreign objects;
- use a mask and darken below eyes with charcoal to avoid recurrence; and
- wear sunglasses.

DEHYDRATION

Dehydration is a condition that occurs when a person loses more fluids than they consume. The human body is made up of about two thirds water and when someone gets dehydrated, it means the amount of water in the body has dropped below the level needed for normal body function (low fuel).

To avoid dehydration one must drink plenty of water. It is recommended that a person drink 1.2 litres (six to eight glasses) of water every day. When exercising consumption of water should increase to one litre of water per hour of exercise on top of the normal daily amount. Water intake should also be increased if exercising in warmer conditions or during hotter weather periods as one will sweat more and lose fluid from the body.

Results and Symptoms of Fluid Loss:

Fluid Loss 1 to 5 percent	Fluid Loss 6 to 10 percent	Fluid Loss 11 to 20 percent
<ul style="list-style-type: none"> • Thirst • Vague discomfort • Lack of appetite • Flushed skin • Impatience • Sleepiness • Nausea 	<ul style="list-style-type: none"> • Dizziness • Headache • Laboured breathing • No saliva • Indistinct speech • Unable to walk 	<ul style="list-style-type: none"> • Delirium/disorientated • Swollen tongue • Unable to swallow • Dim vision • Numbed and shrivelled skin

CONFIRMATION OF TEACHING POINT 2

QUESTIONS

- Q1. What are three heat related injuries?
- Q2. If you were exposed to ultraviolet light for a prolonged period of time, what would occur?
- Q3. What are the symptoms of heat stroke?

ANTICIPATED ANSWERS

- A1. Heatstroke, dehydration, heat exhaustion.
- A2. Sunburn.
- A3. Hot dry skin, flushed face and feverish (sweating stops), rise in temperature, pulse rapid and strong, severe headache, often with vomiting, unconsciousness may follow.

END OF LESSON CONFIRMATION

QUESTIONS

- Q1. Describe the preventative steps to take to avoid exposure to hyperthermia?
- Q2. How can a cadet avoid dehydration?
- Q3. How can a cadet prevent sunburn?

ANTICIPATED ANSWERS

- A1. Any of the following: take extra clothing, avoid sweating and long-term cooling, eat often, drink plenty of water, keep active, and check each other often.
- A2. To avoid dehydration one must drink plenty of water. It is recommended that a person drink 1.2 litres (six to eight glasses) of water every day. When exercising, consumption of water should increase to one litre of water per hour of exercise on top of the normal daily amount. Water intake should also be increased if exercising in warmer conditions or during hotter weather periods as one will sweat more and lose fluid from the body.

- A3. The best prevention for sunburn is to remain covered as much as possible, and to apply sunscreen with a minimum SPF rating of 30 to any exposed skin.

CONCLUSION

HOMEWORK/READING/PRACTICE

Nil.

METHOD OF EVALUATION

Nil.

CLOSING STATEMENT

Cadets should now be better prepared to recognize environmental related injuries, and injuries to which they are susceptible while participating in field training exercises in any season.

INSTRUCTOR NOTES/REMARKS

This lesson should be delivered prior to the bivouac exercise.

REFERENCES

C2-004 (ISBN 1-896713-00-9) Tawrell, P. (1996). *Camping and Wilderness Survival: The Ultimate Outdoors Book*. Green Valley, ON: Paul Tawrell.

C2-008 (ISBN 0-00-265314-7) Wiseman, J. (1999). *The SAS Survival Handbook*. Hammersmith, London: Harper Collins Publishers.

C2-009 (ISBN 0-684-85909-2) Harvey, M. (1999). *The National Outdoor Leadership School's Wilderness Guide*. New York, NY: Fireside.

THIS PAGE INTENTIONALLY LEFT BLANK



ROYAL CANADIAN ARMY CADETS
GREEN STAR
INSTRUCTIONAL GUIDE



SECTION 7
EO M121.07 – ERECT A GROUP TENT

Total Time: 60 min

PREPARATION

PRE-LESSON INSTRUCTIONS

Resources needed for the delivery of this lesson are listed in the lesson specification located in A-CR-CCP-701/PG-001, *Green Star Qualification Standard and Plan*, Chapter 4. Specific uses for said resources are identified throughout the instructional guide within the TP for which they are required.

Review the lesson content and become familiar with the material prior to delivering the lesson.

PRE-LESSON ASSIGNMENT

Nil.

APPROACH

A demonstration was chosen for TPs 1 and 3 as it allows the instructor to demonstrate the process of erecting and striking a tent in a controlled environment.

A performance was chosen for TPs 2 and 4 as it allows cadets the opportunity to practice erecting and striking a tent under supervision.

INTRODUCTION

REVIEW

Nil.

OBJECTIVES

By the end of this lesson the cadet shall be expected to erect a tent as a member of a group and organize their personal tent space.

IMPORTANCE

Shelters are important to protect cadets against weather and offer sleep areas. Ineffective shelters will hamper training and put cadets at risk.

Teaching Point 1**Introduce tents.**

Time: 15 min

Method: Demonstration



Cadets will use commercial tents, which come in various sizes and forms, and therefore have different materials and ways to be erected. Instructors and users should read the information booklets provided with the tent used in order to become familiar with how to erect it.

TENT INFORMATION

Modern tent styles include dome, tunnel and ridge (or A-frame) designs. Tents are rated as either a three-season or a four-season shelter. Three-season tents are designed to offer good ventilation in spring, summer and fall, and provide sturdy weather protection in everything but heavy snowfalls and very high winds. Many three-season tents have mesh inner bodies, which reduce condensation, and can often be used without the fly for a cool, bug-proof shelter on hot nights. Three-season tents are airier, less expensive, lighter and more compact or roomier than four-season tents. Their versatility makes them popular with backpackers, paddlers and cyclists. A four-season tent is made of stronger materials and is designed to withstand strong winds and for use in cold environments. For backpacking expeditions, choose a tent or shelter that offers sufficient protection for a person and their kit. No tent or shelter is fireproof, so use extreme caution with an open flame.

Each tent will be rated for the number of people that are supposed to fit in the tent to sleep. Tents, when purchased, should be chosen and rated for at least one more person than planned allowing room for kit. Some tents have a small sheltered area at the door, called a vestibule, to allow a storage area for kit.

Some tents use a separate “fly” (a waterproof tarp that fits over the tent) to keep you dry, while others have just a single wall and roof with waterproof qualities. All tents must be dried completely before long term storage.

PARTS OF A TENT

www.mec.ca/tam3

Figure 1 Sample Tent with Labelled Parts (No Guy Lines)

Pre-made shelters come in many styles, sizes, shapes and materials. Most will use some common items such as:

- Poles (aluminium, carbon fibre or fibreglass). These are to be used to support the material portions of the tent;
- Guy lines (for support). These may be constructed from a lightweight, water-resistant material, and are stretched out from the material of the tent to lend shape and stability to the tent;
- The proper tent. Tents and shelters are traditionally made from nylon, polyester, canvas or cotton material, and are often one large piece, into which poles etc., are inserted;
- Pegs. Some tents require pegs to be driven into the ground for additional support of the tent structure, or to hold the ends of the guy lines; and
- The fly. Many tents utilize a fly in order to provide additional weatherproofing. Often flies provide a vestibule, or compartment at the front or rear door to the tent, in which an additional kit can be stored.

CONFIRMATION OF TEACHING POINT 1

QUESTIONS

- Q1. What size tent should be used if planning on sleeping two persons with kit?
- Q2. What seasons are tents rated for and what is the difference between the two?
- Q3. What is the tarp-like material called that fits over the top of a tent?

ANTICIPATED ANSWERS

- A1. Three person if planning on storing a kit inside.
- A2. Three-season and four-season tents. Three-season tents are made for spring summer and fall, four season are made of stronger materials and are designed to withstand strong winds and be used in cold environments.
- A3. Fly.

Teaching Point 2

Explain and demonstrate erecting a tent.

Time: 20 min

Method: Demonstration and Performance

PITCHING AND ANCHORING



Pitching (erecting)

- Instructors are to show the cadets how to erect the commercial tent that is being employed by the cadet unit.
- Gather cadets in an appropriate location and go through the erection of the commercial tent, step by step as set out in the manufactures instructions.

Keep in mind the following points when pitching a tent:

- find a sheltered area;
- avoid overhanging tree branches and other overhead hazards;
- avoid areas in the radius of any dead trees in case the wind or other environmental factor topples them;

- avoid open hilltops giving exposure to wind and lightning;
- avoid depressions where water might pool after rainfall;
- ensure you are at least 100 m from your cooking area (bears and other animals will be attracted to food smells);
- orient the opening of the shelter away from the wind;
- ensure sleeping surface is cleared of any sharp objects, large twigs and rocks; and
- never pitch a shelter on a road or path.

To lessen the impact on the environment and other wilderness users:

- ensure you are at least 100 m from open water – local wildlife relies on water access for survival and your presence at the water's edge may interrupt their habits;
- select a shelter site out of the direct view of other wilderness users – at least 10 m from a trail, path or road; and
- erect the shelter on a durable surface like sand, rock or grass – fragile plant life may be permanently damaged by use of the area. Avoid moving large stones and branches.

When pitching, the strength of a tent depends on the construction, design and quality. Equally a great deal of strength is achieved when a tent is properly pitched. A tightly pitched tent is stronger, more aerodynamic, keeps drier in a storm, and lasts longer than a loose and sagging tent. When pitching ensure to:

- stake tent ensuring all cords are taut (having no slack or give); and
- make tent and fly taut with all various tie downs provided.



A taut tent is stronger, and sheds rain and snow more effectively.

ACTIVITY – ERECT A PERSONAL TENT

OBJECTIVE

- This activity's objective is to have the cadets erect a tent with a properly laid out tent space.

RESOURCES

- Tents.
- Personal kit (backpack and material contained within).
- Sleeping bags.
- Air mattresses.

ACTIVITY LAYOUT

This activity will be run as a competition, similar in nature to the principles of a game. The cadets will be challenged to completely set up a tent, and organize their tent space, in 40 minutes. The instructions are as follows:

- cadets will be assigned to tent groups corresponding to the number of persons a provided tent can hold. These shall be the groups in which the cadets will be sleeping for the duration of the FTX;

- the cadet tent groups will be assigned a tent site location as determined prior to this lesson;
- cadets will erect tents according to the manufacturer's instructions as discussed in TP1;
- once cadets have been assigned tent groups and tent locations (as previously determined), explain to the cadets that there will be a small challenge on tent construction;
- cadets will be given a time limit of 15 minutes to erect a tent and set up their tent space;
- the instructor will continuously supervise cadets throughout this teaching point, giving direction where required; and
- assistance and supervision from other staff may be required, and is encouraged.

SAFETY

- Cadets are to be supervised throughout this lesson.
- Ensure that if any tools (i.e. axes, knives, hammers) are to be used, it is done with direct supervision.

INSTRUCTOR GUIDELINES

- During this activity the instructor must continually supervise the cadets.
- Constantly be aware of what is happening at the tent sites.
- Assist cadets experiencing difficulties, keeping in mind this is a competition.
- Once time has expired, assess the tents to see which group has the best completed shelter (see TP2 – Confirmation, for details on assessment criteria).
- Once winners have been determined, be creative and reward the cadets.

CONFIRMATION OF TEACHING POINT 2

Tent assessment criteria:

- sleeping surface clear, void of any sharp objects that could be a danger to the tent; and
- tent is set up according to manufacturer's instructions, ensuring:
 - pegs are holding the tent to the ground, and in proper locations relative to the tent;
 - guy lines are taut and placed in a safe location, contributing to the overall strength of the tent;
 - poles are fully assembled and secured; and
 - any other criteria detailed in TP2 that may be applicable.

Teaching Point 3

Explain and demonstrate striking a tent.

Time: 5 min

Method: Demonstration and Performance

TENT SPACE

Where pre-made shelters come in many styles, sizes, and shapes, it is difficult to specify one particular tent space layout that is conducive to all types; however, there are a few common guidelines all campers should follow:

- during warm or clear days, the tent doors are left open to allow air to flow through (fly is closed);
- air mattress is laid out in tent if self inflating, allow time for air to fill mattress;

- sleeping bag left rolled up until prior to sleeping if a down sleeping bag is used, allow time for bag to fluff and fill with air;
- maintain a clean space, as dirt or other objects may tear the tent;
- kit is stored at the foot of tent or outside under a tarp;
- remove footwear upon entry (reduces dirt and water inside the tent); and
- do not store food inside a tent.

CONFIRMATION OF TEACHING POINT 3

The instructor shall have the cadets organize their bed space, and shall correct errors as soon as possible. The bed space shall be assessed by the instructor, ensuring:

- the sleeping space is tidy and properly laid out;
- the air mattress is laid out flat, with self-inflating valve open, allowing air to fill;
- sleeping bag is still stored; and
- any other criteria from TP3 are considered, as applicable.



The instructor may end the lesson at this point, and have the cadets carry on with other activities, in accordance with the training schedule for the FTX. TP4 may be scheduled to take place at the end of the FTX, as part of site teardown.

Teaching Point 4

Striking.

Time: 20 min

Method: Demonstration and Performance



The instructor shall demonstrate the complete process for removing a tent from a campsite, or **striking** the tent. The cadets shall then strike their tents, under supervision, while the instructor provides feedback.

STRIKING

To remove a tent from the campsite, one must first strip the tent site of all components belonging to the tent. Importance should be placed on removing pieces of string or rope that are used to tie down the structure. The sleeping surface should be returned to its original appearance (replacing sticks and stones removed for sleeping). Remove any leftover garbage.



Where time permits, corps may choose to include a similar activity to that presented in TP2.

FOLDING AND STORAGE

Pre-made shelters come in many styles, sizes, and shapes with different materials. For proper folding of the tent follow the manufacture's instructions.

Upon completion of a camping trip, and when storing a tent for a prolonged time, a camper should:

- shake out the tent to remove any dirt or debris from the inside of the tent;
- wash the tent with a sponge and water;
- dry thoroughly. If a wet tent is stored, the combination of room temperature heat, dirt, and water will lead to mould growth and break down the tent's material;
- store tent loosely in a oversized, breathable bag, allowing for any condensation that forms to evaporate easily;
- store tent poles fully assembled, reducing the stress on the elastic cords. If this is not possible, they should be folded in halves to provide equal stretch along the elastic cord and storing loosely in a large bag will further reduce the stress; and
- store away from sunlight in a cool, dark and dry location.

CONFIRMATION OF TEACHING POINT 4

The cadets shall be required to imitate, under supervision, the striking of a tent as a member of a group while the instructor provides feedback. The instructor should ensure additional instructors are on hand, should supervision of all tent groups prove difficult.

END OF LESSON CONFIRMATION

The confirmation of these skills will occur throughout the FTX, with the cadets first pitching and organizing a tent, and later striking and packing the tent away for storage.

CONCLUSION

HOMEWORK/READING/PRACTICE

Nil.

METHOD OF EVALUATION

Nil.

CLOSING STATEMENT

A properly set up tent will ensure a comfortable, secure and stable shelter. A well organized tent space will also contribute to a pleasant overnight camping experience.

INSTRUCTOR NOTES/REMARKS

This lesson shall be delivered practically during the bivouac FTX. Setting up and striking of tent will occur as per FTX schedule (eg, arrival and prior to departure).

Time allocation is approximate, as it may vary based on the group.

REFERENCES

C2-009 (ISBN 0-684-85909-2) Harvey, M. (1999). *The National Outdoor Leadership School's Wilderness Guide*. New York, NY: Fireside.



ROYAL CANADIAN ARMY CADETS
GREEN STAR
INSTRUCTIONAL GUIDE



SECTION 8

EO M121.08 – APPLY “LEAVE NO TRACE” CAMPING

Total Time:

60 min

PREPARATION

PRE-LESSON INSTRUCTIONS

Resources needed for the delivery of this lesson are listed in the lesson specification located in A-CR-CCP-701/PG-001, *Green Star Qualification Standard and Plan*, Chapter 4. Specific uses for said resources are identified throughout the instructional guide within the TP for which they are required.

Review the lesson content and become familiar with the material prior to delivering the lesson.

PRE-LESSON ASSIGNMENT

Nil.

APPROACH

An interactive lecture was chosen for this lesson to introduce the cadets to the concept of “Leave no Trace” camping.

INTRODUCTION

REVIEW

Nil.

OBJECTIVES

By the end of this lesson the cadet shall be expected to practice the principles of “Leave no Trace” camping during the conduct of a bivouac field training exercise (FTX).

IMPORTANCE

Expedition training is a large component of the Army Cadet Program. From corps training to the international expeditions, there are multiple opportunities to participate in expedition training. The knowledge presented in this lesson will enable the cadets to participate effectively, while respecting the environment and leaving it in its natural condition.

Teaching Point 1**Explain the seven principles of “leave no trace” camping.**

Time: 25 min

Method: Interactive Lecture



This lesson is to be delivered in the field, in two stages.

Stage 1. The instructor is required to cover the seven principles of “Leave no Trace” camping in the interactive lecture format within 15 minutes. A handout found at Annex A labelled The Principles of “Leave no Trace” Camping has been produced for the cadets’ use.

Stage 2. At the end of Stage 1 the instructor will break cadets into seven small groups, assign a principle of no trace camping to each and have them develop a charade associated with the principle. Ten minutes have been allotted for this activity.

In some areas of the country results of overuse are very apparent. Trails are so deeply eroded in some places that the tree roots form a spider web structure a foot or more above the ground. Fire rings, garbage, and bare, lifeless patches of earth are common, but those are only the obvious signs of impact. There are many others that are less evident, such as water pollution, and the elimination of various plants and animals. These are some of the reasons why the no-trace camping ethic was adopted. The following seven principles are guidelines to follow when partaking in any outdoor adventure training activity.

PLANNING AHEAD AND PREPARING

Plan ahead by considering your goals and expectations. Taking steps in advance of the trip will allow for minimum impact on the trail. Some points to help prepare include:

- **Knowing the Regulations and Special Concerns for the Areas Visited.** The environment is very diverse. Taking the time to research specific locations will aid the group in packing and preparation.
- **Preparing for Extreme Weather, Hazards and Emergencies.** Information concerning weather, possible hazards, and emergencies should never be assumed or the importance underestimated. Check with weather forecasting services and research the trip location’s seasonal weather history for any clues to weather that may be expected. Always plan for the worst weather expected, and be prepared for any emergency.
- **Carefully Planning Meals and Repackaging Food to Minimize Waste.** Reducing the amount of food you carry by carefully planning meals and repackaging food will reduce the amount of garbage carried. Eliminating such trash reduces the possibility of accidentally leaving waste behind.

TRAVELLING AND CAMPING ON DURABLE SURFACES

Trampled vegetation and eroded trails last for years, or even a lifetime. Choose to set ones feet and tents on surfaces that endure (i.e., rock, sand, gravel, dry grasses, snow, or water). The following guidelines should be adhered to:

- **Concentrating Hike on Existing Trails and Campsites.** In popular areas, focus the hike where it is obvious that other visitors have already left an impact. Travelling on areas already worn will reduce the overall impact on the environment in the long term.
- **Walking in Single File in the Middle of the Trail, Even When Wet or Muddy.** Trails travelled frequently will show signs of wear. Maintaining travel in the centre of the path will reduce wear spreading to the edges of the trail.
- **Avoid Taking Short Cuts Away From Established Trails.** Stay on trails. Short cutting around routes or obstacles may be time saving and rewarding; however, the effect on the vegetation and environment is damaging.

- **Travel on Rock, Gravel, Dry Grasses or Snow.** These surfaces are durable and can withstand the pressure of human travel. In pristine areas with no noticeable impact, groups should not walk in single file, but should disperse and travel separate routes.
- **Camping 100 Metres from Lakes and Streams.** Ground water, and water from lakes and streams, have the potential to be spoiled by increased human contact. By camping a minimum distance of 60 metres from these water sources, cadets can do their part to limit the impact on the area's ecosystem.

DISPOSE OF WASTE PROPERLY

Pack it in, Pack it Out. Inspect the campsite and rest areas for trash or spilled foods. Pack out all trash, leftover food and litter.

Disposing of Human Waste. Deposit all human waste in cat holes dug 16 to 20 centimetres deep and at least 60 metres from water sources, camps, and trails. Cover and disguise the cat hole when finished. Be sure to follow any additional direction provided by the owner or manager of the area you are training in, and to adhere to any regional directives that may be in place.

Pack Out Toilet Paper and Hygiene Projects. Soiled toilet paper and feminine products will take a considerable amount of time to decompose. Especially if hike involves many participants. Be sure to employ a suitable disposal plan.

Washing Body or Dishes. Carry water 60 metres away from streams or lakes and use small amounts of biodegradable soap. Scatter strained dishwater.

LEAVE WHAT YOU FIND

While hiking there will be many wonderful structures, intriguing objects, and items one will find interesting. Items of such nature shall be left alone for others to cherish.

- **Preserving the Past.** Cultural or historical structures and artefacts shall be left alone for all to enjoy.
- **Leave Flora and Fauna.** Plants, rocks, and animals shall be left alone and undisturbed.
- **Avoid the Construction of Structures.** While in the field, common practice is to invent or construct structures and furniture or dig trenches to make living easier; however, these actions leave a noticeable, unnatural indication of human presence in the environment. If anything is to be created out of necessity, once finished, return the environment to its original appearance.

MINIMIZING CAMPFIRE IMPACTS

The lasting impacts of traditional open fires destroy the landscape, and can be avoided by using lightweight stoves. If fires are acceptable, build minimum impact fires using an existing fire ring, pan or fire mound. Only dead and downed wood, nothing bigger than an adult's wrist, should be used. Maintain a small fire by burning all the wood down to ash, then saturating the ash with water and scattering the ash broadly. There should be little to no evidence of a fire.

RESPECT WILDLIFE

Animals in their natural environment are not used to humans. Although some wild animals adapt to human presence, others flee, sometimes abandoning their young and their preferred habitat. As guests in the environment, and as expeditionists, we should respect the wildlife by observing some simple guidelines such as:

- observing wildlife from a distance;
- never feeding the animals;
- protecting wildlife and food by storing rations and trash securely;

- controlling pets; and
- avoiding wildlife during sensitive times (i.e., mating, nesting, when raising young, or during the winter).

BEING CONSIDERATE TO OTHER VISITORS

During hiking, one will likely encounter other travelers. Be sure to afford common courtesies and respect to others, such as:

- respecting visitors, to protect the quality of their experience;
- yielding to others on the trail;
- camping away from trails and other visitors; and
- allowing nature's sounds to prevail, by avoiding loud voices and noises.

CONFIRMATION OF TEACHING POINT 1

ACTIVITY – CHARADES

Time: 10 min

OBJECTIVE

Recognize the seven principles of "Leave no Trace" camping.

RESOURCES

Nil.

ACTIVITY LAYOUT

- This activity will be a participative learning activity achieved through a small group charade. The cadets will be broken down into seven small groups and given a principle of "leave no trace" camping. The cadet groups will be expected to act out a principle while the other groups look on and guess what principle is being acted out. The following instructions detail specifically how to carry out this activity.
- Activity instructions:
 - divide cadets into seven small groups;
 - assign each group a principle of "Leave no Trace" camping;
 - give cadets 30 seconds to develop a silent charade no longer than one minute in length to present to the group;
 - in random order have cadet groups present their charade to the group;
 - if time is available, repeat charade only changing the principle each group has; and
 - the activity can be a challenge where the group with the most correct guesses wins.

Note: This activity may also be conducted in the evening, giving the cadets more time to rehearse their charades and to then perform them.

SAFETY

Instructor will use personal judgement during the conduct of specific charades and intervene if it is determined that safety is being jeopardized. This is a supervised activity.

INSTRUCTOR GUIDELINES

Instructors are to continuously supervise and monitor the activity to ensure the material being presented is represented correctly.

END OF LESSON CONFIRMATION

QUESTIONS

- Q1. What are the seven principles of "Leave no Trace" camping?
- Q2. When in the wilderness, squirrels are often present around the campsite. How much food should you spare to feed the animals?
- Q3. When preparing for a hike what should one check to determine what clothing will be required for the trip?

ANTICIPATED ANSWERS

- A1. (1) Plan ahead and prepare, (2) Travel and camp on durable surfaces, (3) Dispose of waste properly, (4) Leave what you find, (5) Minimize campfire impacts, (6) Respect wildlife, (7) Be considerate of other visitors.
- A2. None, animals in the wild are not to be fed.
- A3. Weather forecasts and the locations seasonal weather history.

CONCLUSION

HOMEWORK/READING/PRACTICE

Cadets should review the seven principle of "Leave no Trace" camping.

METHOD OF EVALUATION

Nil.

CLOSING STATEMENT

Expedition training is an important component of the Army Cadet Program. Knowing how to maintain our environment - giving it the respect it deserves - will be the challenge presented to cadets daily when participating in expeditions. The knowledge acquired here will enable the cadets to participate in such expeditions while leaving the environment in its natural condition.

INSTRUCTOR NOTES/REMARKS

This lesson shall be delivered during the bivouac FTX.

In some cases this lesson could be conducted as a tour of the local area, selecting areas where specific principles could be best explained.

REFERENCES

C2-011 (ISBN 0-89886-910-2) McGivney, A. (2003). *Leave No Trace, a Guide to the New Wilderness Etiquette*. Seattle, WA: Mountaineers Books.

HANDOUT – THE PRINCIPLES OF LEAVE NO TRACE CAMPING

Planning Ahead and Preparing	Travelling and Camping on Durable Surfaces
<ul style="list-style-type: none"> • Know the regulations and special concerns for the areas visited. • Prepare for extreme weather, hazards and emergencies. • Carefully plan meals and repackage food to minimize waste. 	<ul style="list-style-type: none"> • Concentrate the hike on existing trails and campsites. • Walk in single file in the middle of the trail, even when wet or muddy. • Avoid taking short cuts off established trails. • Travel on rock, gravel, dry grasses or snow. • Camp 60 metres from lakes and streams.
Dispose of Waste Properly	Leave What You Find
<ul style="list-style-type: none"> • Pack it in, pack it out. • Dispose of human waste. • Pack out toilet paper and hygiene projects. • Wash body or dishes. 	<ul style="list-style-type: none"> • Preserve the past. • Leave flora and fauna. • Avoid the construction of structures.
Minimizing Campfire Impacts	Respect WildLife
<ul style="list-style-type: none"> • Build minimum impact fires by using an existing fire ring, pan or fire mound. • Burn only dead and downed wood. • Maintain a small fire by burning all the wood down to ash, then saturating the ash with water and scattering the ash broadly. • There should be no evidence of a fire. 	<ul style="list-style-type: none"> • Observe wildlife from a distance. • Never feed the animals. • Protect wildlife and food by storing rations and trash securely. • Control pets. • Avoid wildlife during sensitive times (i.e. mating, nesting, when raising young, or during the winter).
Be Considerate to Other Visitors	
<ul style="list-style-type: none"> • Respect visitors to protect the quality of their experience. • Yield to others on the trail. • Camp away from trails and other visitors. • Allow nature's sounds to prevail. Avoid creating loud noises. 	

THIS PAGE INTENTIONALLY LEFT BLANK



ROYAL CANADIAN ARMY CADETS
GREEN STAR
INSTRUCTIONAL GUIDE



SECTION 9
EO M121.09 – FOLLOW CAMP ROUTINE

Total Time: 60 min

PREPARATION

PRE-LESSON INSTRUCTIONS

Resources needed for the delivery of this lesson are listed in the lesson specification located in A-CR-CCP-701/PG-001, *Green Star Qualification Standard and Plan*, Chapter 4. Specific uses for said resources are identified throughout the instructional guide within the TP for which they are required.

Review the lesson content and become familiar with the material prior to delivering the lesson.

PRE-LESSON ASSIGNMENT

Nil.

APPROACH

A practical activity was chosen for TP 1 as it is an interactive way to allow cadets to learn about bivouac site layout and components in a safe and controlled environment.

A demonstration and performance was chosen for TP 2 as it allows the instructor to demonstrate and explain hygiene in the field while providing an opportunity for the cadets to practice (during the FTX) the skill under supervision.

INTRODUCTION

REVIEW

Nil.

OBJECTIVES

By the end of this lesson the cadet shall be expected to follow camp routine, recognize the components of a bivouac site and carry out personal hygiene in the field.

IMPORTANCE

Cadets will be required to take part in numerous exercises. It is imperative they understand a bivouac's layout, and how maintaining hygiene is a task all cadets will be expected to perform.

Teaching Point 1**Conduct a guided tour of a bivouac site describing the layout of each component.**

Time: 20 min

Method: Practical Activity

COMPONENTS OF A BIVOUAC SITE

This teaching point is to be covered in the field following the set-up of the bivouac site in the form of an activity, detailed at the end of this teaching point.

LAYOUT OF A BIVOUAC

Elements of the bivouac should include:

Element	Description
• Headquarters	• Location of OIC, communication centre.
• First aid station	• Central point containing first aid kit, stretcher etc.
• Supply	• Staffed by supply officer/company quartermaster sergeant. All stores not in use to be held here.
• Toilets	• Portable toilets or approved hand dug latrines.
• Wash station	• Established area for washing/ablutions. May have one for males and another for females.
• Mess/eating area	• Central point for all foods to be consumed. Assists in the control of waste and garbage, especially in areas with high animal activity.
• Fire pit	• A safe, vegetation free area to be used by group. Should be away from sleeping area, preventing incidents related to sparks/fire.
• Fire point	• A centrally located, accessible point housing the firefighting equipment.
• In/out route for safety vehicle	• Established routes to control vehicle traffic. This helps make the site safe from vehicle traffic, and prevents undue wear and tear on the environment.
• Vehicle parking area	• Clearly identified area for parking of exercise support vehicles. This area should be equipped with drip pans, to be placed under the engine of the vehicle.
• Drinking water point	• Location for storage/drawing of drinking water.
• Petroleum, Oils, Lubricants (POL) point	• Clearly marked storage area for fuels.

Element	Description
<ul style="list-style-type: none"> Female/male quarters 	<ul style="list-style-type: none"> Sleeping areas.
<ul style="list-style-type: none"> Garbage point 	<ul style="list-style-type: none"> Central point for collection/storage of garbage.

 Once listed aspects of the bivouac site have been discussed, the cadets will tour the site with the instructor who will describe the layout of each component and explain why they are located where they are. A tie back to discuss "Leave no Trace" principles from EO M121.08 (Section 8) can also enhance this tour.

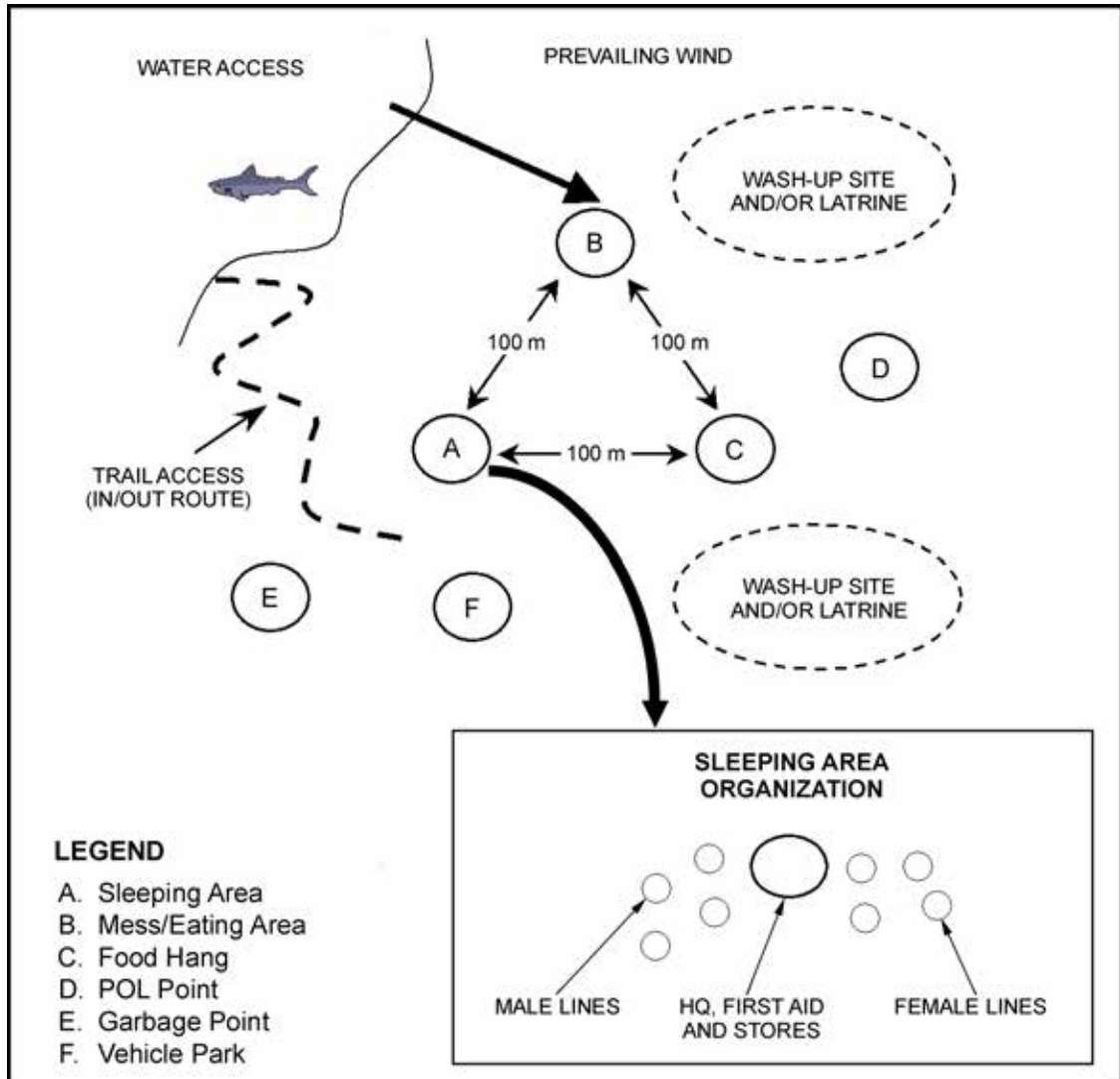

Army cadet reference hand book

Figure 1 Sample Bivouac Site

ACTIVITY

Time: 20 min

OBJECTIVE

Familiarize cadets with the components and layout of a bivouac site.

RESOURCES

Bivouac site components:

- Sleeping area.
- Mess/eating area.
- Food hang (If applicable).
- HQ, first aid and stores.
- Male lines.
- Female lines.
- POL point.
- Garbage point (animal-proof).

ACTIVITY LAYOUT

- This activity should take place after senior cadets have set up the bivouac site. The site components must be clearly labelled for the green star cadets.
- Prior to the tour the instructor shall take a moment and review with the cadets what they will see throughout the tour.
- In a fluid rotation, guide cadets through the bivouac site, giving explanations for each component of the site and its purpose.
- Twenty minutes are allotted for this guided tour. Be sure at the end of the tour to question cadets on the bivouac site components.

SAFETY

This is a supervised lesson. It is strongly recommended that additional staff accompany cadets throughout the tour.

INSTRUCTOR GUIDELINES

The instructor will be responsible to supervise the cadets, while explaining each component of the bivouac, during the guided tour. Attention should also be paid to opportunities to tie back to leave no trace principles from EO M121.08 (Section 8).

CONFIRMATION OF TEACHING POINT 1

The tour shall serve as the confirmation.

Teaching Point 2**Explain, and demonstrate where practical, how to carry out personal hygiene in field.**

Time: 30 min

Method: Demonstration and Performance



The following points are provided as background information for the instructor to use in the conduct of the activity for this teaching point.

HYGIENE

A high standard of personal hygiene is important in the field, as it protects against illness and promotes good health. Clothing and equipment, as well as the body, must stay clean and dry. Change clothes, especially socks and undergarments, regularly. Avoid soaps or shampoos with perfumes or strong odours; such scents will attract animals and insects. Good personal hygiene not only makes a person feel better, but peers will appreciate it too!

- **Washing.** Shall be conducted daily ideally using clean water or snow. Wash hands carefully with water and soap after dirty work, going to the washroom, and before cooking or eating. When water or privacy is restricted, wash at least the areas of the body that sweat the most: face, neck, feet, armpits and groin (Moist wipes are a quick and useful tool for cleaning the body in the field).
- **Hair.** Keep hair neat and wash with soap or shampoo at least once a week.
- **Teeth.** Brush teeth and use floss at least twice a day. Table salt or baking soda can be used as substitutes to toothpaste. If you do not have a toothbrush chewing a green twig to a pulpy consistency will work, as will rubbing the teeth with a piece of gauze. Rinse your mouth after each meal.
- **Feet.** Use foot powder on the feet, and body powder on the groin, to help avoid chafing in warm weather. Petroleum jelly will also help protect from chafing, especially in sensitive areas.
- **Regular Bowel Movements.** It is very important to go to the washroom regularly. Daily bowel movements will keep the system working properly. A change in activity and diet will often put extra stress on the digestive system, so maintain a healthy diet and drink plenty of fluids. Never try to “hold it” when it is necessary to go, especially at night, as a person will lose sleep and become uncomfortable.
- **Treating Injuries.** (Minor cuts, infections, and bruises). Even minor injuries are potentially serious if they become infected. Carefully treat every cut, sprain or bruise.
- **Shaving.** Where practical, cadets should shave daily. Because essential oils are stripped from the skin during shaving, in a cold climate, this is best performed prior to going to bed.

ACTIVITY

Time: 30 min

OBJECTIVE

Discuss and demonstrate to the cadets, the importance of hygiene in the field.

RESOURCES

Complete hygiene kit.

ACTIVITY LAYOUT

- For this activity the instructor will require a hygiene kit and, if possible, a hygiene station where all items inside the hygiene kit can be laid out and presented for all cadets to view.
- The goal will be to explain and demonstrate how to maintain personal hygiene in the field. Where practical, demonstrations could be examples or acts of the actual method.
- If time permits, have cadets brush their teeth and check their feet during the activity.

SAFETY

This is a supervised activity.

INSTRUCTOR GUIDELINES

The instructor will be responsible for the conduct of the cadets.

CONFIRMATION OF TEACHING POINT 2

QUESTIONS

- Q1. How often should a person wash their hair when in the field?
- Q2. What can substitute for toothpaste?

ANTICIPATED ANSWERS

- A1. At least once a week.
- A2. Salt or baking soda.

END OF LESSON CONFIRMATION

Confirmation of this lesson will take place during the activities and throughout the FTX, with the instructor providing advice and making corrections as necessary.

CONCLUSION

HOMEWORK/READING/PRACTICE

Cadets are required to maintain good personal hygiene while on an FTX, and should ensure that proper hygiene is carried out prior to going to bed each night.

METHOD OF EVALUATION

Nil.

CLOSING STATEMENT

Outdoor activities are an important component of the Army Cadet Program. For many cadets the outdoors are an environment that is foreign to them, and their bodies may not be accustomed to dealing with the various natural contaminants found in the outdoors. One way for cadets to protect themselves from injuries and sickness is to maintain a proper daily hygiene routine. Maintaining proper hygiene will not only make the individual cadet feel better, it will make their entire group happier.

INSTRUCTOR NOTES/REMARKS

This lesson shall be delivered during the bivouac FTX.

REFERENCES

C2-004 (ISBN 1-896713-00-9) Tawrell, P. (1996). *Camping and Wilderness Survival: The Ultimate Outdoors Book*. Green Valley, ON: Paul Tawrell.

THIS PAGE INTENTIONALLY LEFT BLANK



ROYAL CANADIAN ARMY CADETS
GREEN STAR
INSTRUCTIONAL GUIDE



SECTION 10

EO C121.01 – CONSTRUCT FIELD AMENITIES

Total Time: 120 min

PREPARATION

PRE-LESSON INSTRUCTIONS

Resources needed for the delivery of this lesson are listed in the lesson specification located in A-CR-CCP-701/PG-001, *Green Star Qualification Standard and Plan*, Chapter 4. Specific uses for said resources are identified throughout the instructional guide within the TP for which they are required.

Review the lesson content and become familiar with the material prior to delivering the lesson.

PRE-LESSON ASSIGNMENT

Nil.

APPROACH

A demonstration and performance was chosen for TP 1 as it allows the instructor to demonstrate and explain how to tie knots while providing an opportunity for the cadets to practice the skill under supervision.

A practical activity was chosen for TP 2 as it is an interactive way to allow cadets to experience creating field amenities in a safe and controlled environment.

INTRODUCTION

REVIEW

The pertinent review for this lesson will include tying of a:

- reef knot EO M121.03 (Section 3); and
- clove hitch EO M121.03 (Section 3).

OBJECTIVES

By the end of this lesson the cadets shall be expected to construct field amenities utilizing the knots and lashings presented.

IMPORTANCE

Field amenities serve many purposes at the bivouac site, from storing food to drying wood. The construction of such objects makes field living more comfortable.

Teaching Point 1

Explain, demonstrate and have the cadets tie knots and lashings used in the construction of field amenities.

Time: 50 min

Method: Demonstration and Performance

KNOTS

Constrictor Knot. With one extra tuck, the clove hitch becomes the constrictor knot and can be tightened around any object. Made with fine twine, it serves as an improvised whipping at the end of a rope. It can also act as a hose clip, or a round clamp when trying to glue a split in a piece of wood. The knot can be pulled extremely tight if it is tied around something like a screwdriver. It may need to be cut loose with a knife as the knot is so tight.



The instructor shall provide an **EXPLANATION** and **DEMONSTRATION** of the complete process.

The instructor shall then provide an **EXPLANATION** and **DEMONSTRATION** of each step required to effectively tie the knot.



The Pocket Guide to Knots and Splices, Des Pawson, 2001

Figure 1 The Constrictor Knot

To tie a constrictor knot:

1. begin with a clove hitch;
2. bring the working end tuck over and under the standing part, making the first half of a reef knot; and
3. pull tight so that the half knot is trapped under the crossing of the clove hitch to finish the knot.



Cadets will **IMITATE** the demonstration provided by the instructor for each step within the process. The instructor(s) will **SUPERVISE** the cadets during this imitation.

Slipped Overhand Knot. Like the overhand knot EO M121.03 (Section 3), this knot serves as a stopper knot, holding objects when the tension is equal at both ends, etc. The addition of a slip allows for quick release. The bight or loop remaining allows the knot to be untied, or “slipped,” by pulling the short end protruding from the knot.



The instructor shall provide an EXPLANATION and DEMONSTRATION of the complete process.

The instructor shall then provide an EXPLANATION and DEMONSTRATION of each step required to effectively tie the knot.

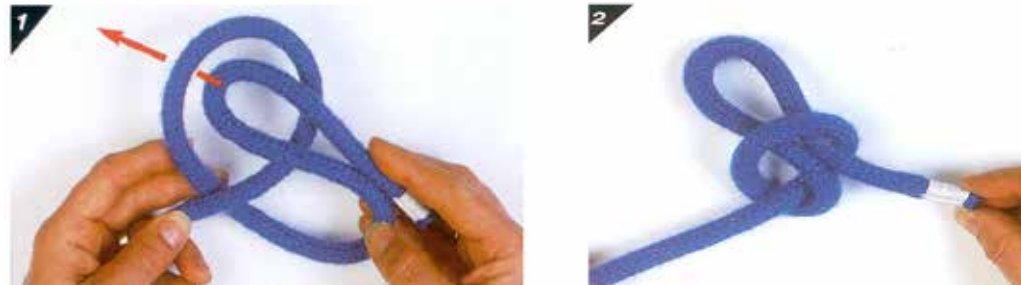

The Pocket Guide to Knots and Splices, Des Pawson, 2001

Figure 2 Slipped Overhand Knot

To tie a slipped overhand knot:

- form a bight in the working part of the rope and tuck as in the overhand knot; and
- tighten the knot.



Cadets will IMITATE the demonstration provided by the instructor for each step within the process. The instructor(s) will SUPERVISE the cadets during this imitation.

Sink Stopper Knot. When a large knot is needed, it is tied at the end of a rope, and usually prevents a rope from being pulled through a hole. It also stops the end of a rope from fraying.



The instructor shall provide an EXPLANATION and DEMONSTRATION of the complete process.

The instructor shall then provide an EXPLANATION and DEMONSTRATION of each step required to effectively tie the knot.

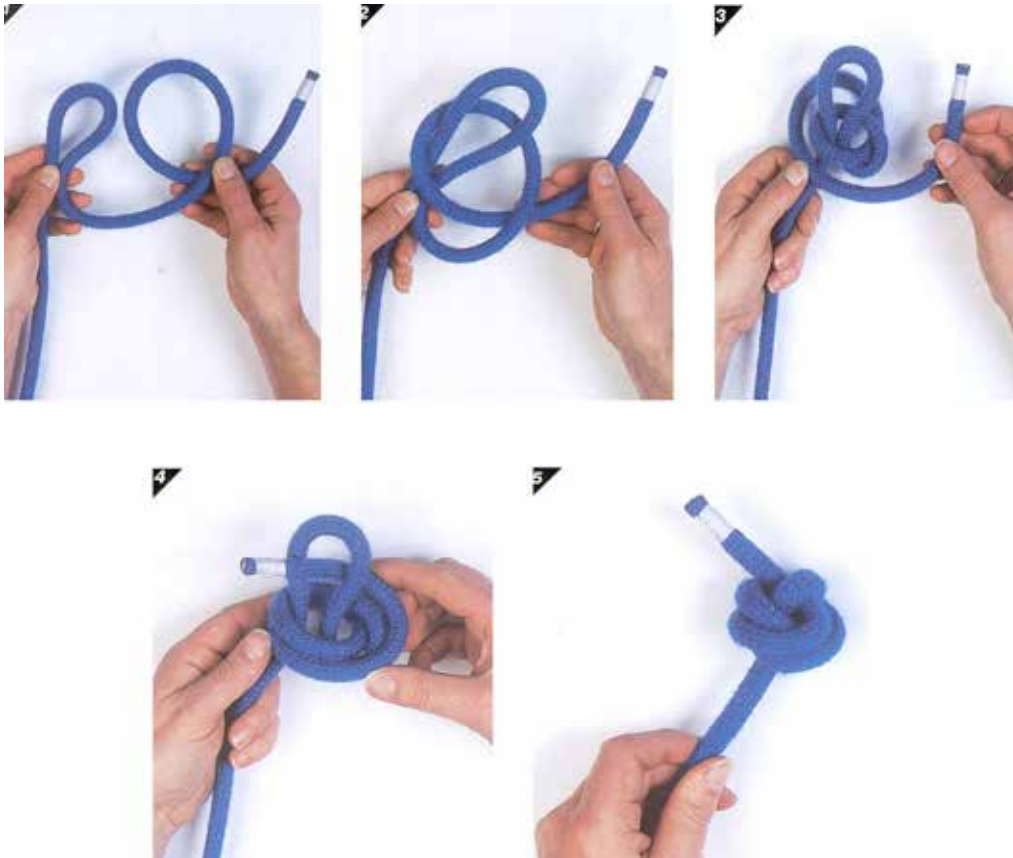

The Pocket Guide to Knots and Splices, Des Pawson, 2001

Figure 3 Sink Stopper Knot

To tie a sink stopper knot:

1. make a crossing turn with the working end passing under the standing part of the rope. Make a bight in the standing part;
2. tuck the bight formed in the standing part up through the loop;
3. tighten a little and take the working part in a counterclockwise direction around the standing part;
4. tuck the working end through the bight, ensuring that the working part fits snugly into the crossing part of the original overhand knot. Work all the slack out to form a neat tight knot; and
5. the knot is finished.



Cadets will IMITATE the demonstration provided by the instructor for each step within the process. The instructor(s) will SUPERVISE the cadets during this imitation.

BENDS

Sheet Bend. One of the simplest and best ways to tie two pieces of rope together. It works best if the ropes are the same or almost the same size.



The instructor shall provide an EXPLANATION and DEMONSTRATION of the complete process.

The instructor shall then provide an EXPLANATION and DEMONSTRATION of each step required to effectively complete the bend.



The Pocket Guide to Knots and Splices, Des Pawson, 2001

Figure 4 Sheet Bend

To tie a sheet bend:

1. fold the end of a piece of rope back on itself to form a bight. If the ropes to be joined are of varying sizes, this should be the larger of the two. Bring the working end of the second piece of rope up through the bight;
2. take the working end of the rope round the shorter end of the first rope and round behind the standing part; and
3. the working end of the second piece is tucked under itself, then pulled tight.



Cadets will IMITATE the demonstration provided by the instructor for each step within the skill. The instructor(s) will SUPERVISE the cadets during this imitation.

Double Sheet Bend. Much like the sheet bend, it is best used if there is a great difference in the size of the two ropes to be joined. It is made with the thinner of the two, and the extra turn in the double sheet bend makes a lot of difference by stopping any slipping, or the knot from collapsing.



The instructor shall provide an EXPLANATION and DEMONSTRATION of the complete process.

The instructor shall then provide an EXPLANATION and DEMONSTRATION of each step required to effectively complete the bend.

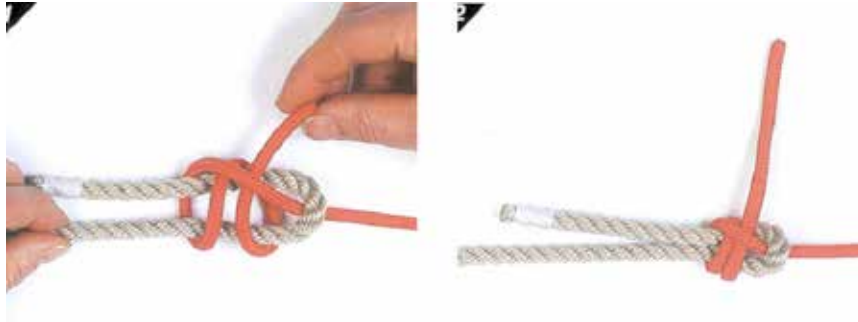

The Pocket Guide to Knots and Splices, Des Pawson, 2001

Figure 5 Double Sheet Bend

To tie a double sheet bend:

1. make the sheet bend, then carry on and make a second pass right round the bight with the working end of the second piece of rope; and
2. pull the finished knot tight.



Cadets will IMITATE the demonstration provided by the instructor for each step within the process. The instructor(s) will SUPERVISE the cadets during this imitation.

LASHING

Sheer Lashing. Has two distinct uses:

- creates an “A” frame or set of sheer legs using one sheer lashing; and
- multiple lashings can be used to bind together a couple of poles to make a larger arm or rod.



The instructor shall provide an EXPLANATION and DEMONSTRATION of the complete process.

The instructor shall then provide an EXPLANATION and DEMONSTRATION of each step required to effectively complete the lashing.

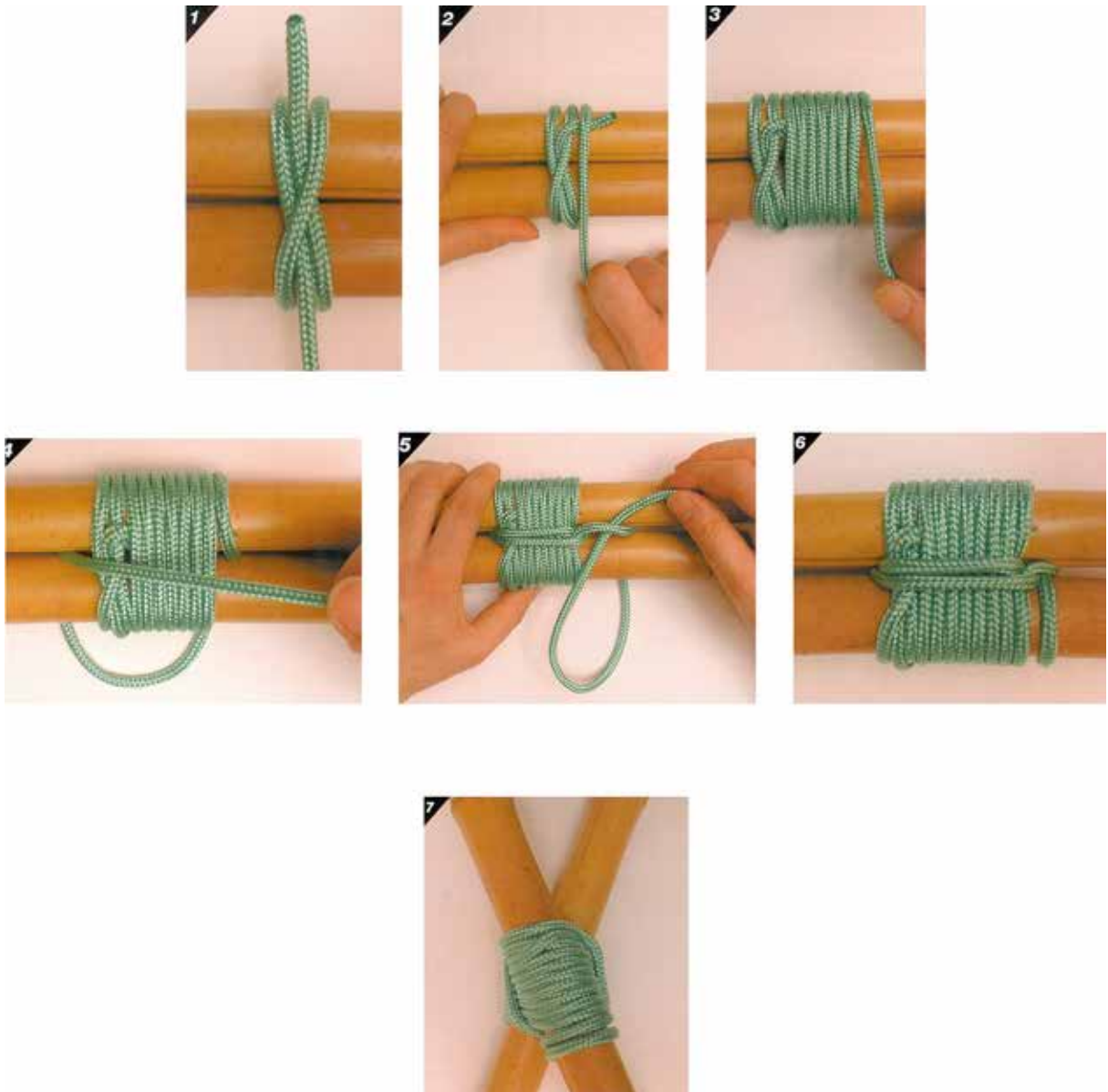

The Pocket Guide to Knots and Splices, Des Pawson, 2001

Figure 6 Sheer Lashing

To tie a sheer lashing:

1. start by making a clove hitch around both poles;
2. wrap round both poles, trapping the end of the clove hitch;
3. carry on making eight to ten more turns round the pair of poles. The lashing could now be finished with a clove hitch round both poles; or
4. add a couple of trapping turns by bringing the end of the rope between the two poles;
5. finish off with a clove hitch around one of the poles;

6. pull the running end tight and tuck the loose end through the parallel poles of the finished sheer lashing; and
7. open the finished sheer lashing to create a pair of sheer legs or "A" frame.



Cadets will IMITATE the demonstration provided by the instructor for each step within the skill. The instructor(s) will SUPERVISE the cadets during this imitation.

CONFIRMATION OF TEACHING POINT 1

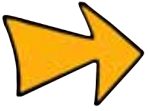

Cadets will PRACTICE the tying each knot, bend and hitch. The instructor(s) will SUPERVISE the cadets during this practice and provide feedback as required.

QUESTIONS

- Q1. What is a sink stopper knot used for?
- Q2. Can a bend tie two pieces of unequal sized rope together?
- Q3. What is one of the uses of a sheer lashing?

ANTICIPATED ANSWERS

- A1. To prevent a rope from being pulled through a hole, or from fraying at the end.
- A2. Yes, it can.
- A3. One of the following: creates an "A" frame, or a set of legs using one sheer lashing, or multiple lashings can be used to bind together a couple of poles to make a larger arm or rod.

Teaching Point 2

Have the cadets create two field amenities.

Time: 60 min

Method: Practical Activity

FIELD AMENITIES

Bear Hang. A bear hang allows the resident of a base camp to store food, while preventing a bear or animal from getting to it.



The Backpacker's Field Manual: A Comprehensive Guide to Mastering Back Country Skills, Rick Curtis, 1998

Figure 7 Bear Hang

Fire Wall Reflector. A fire wall reflector will help shield a fire from wind which can blow it out, and spread the fire and sparks around the bivouac site. It also reflects the heat around the bivouac site. The wall will vary, depending on how high you will need it.

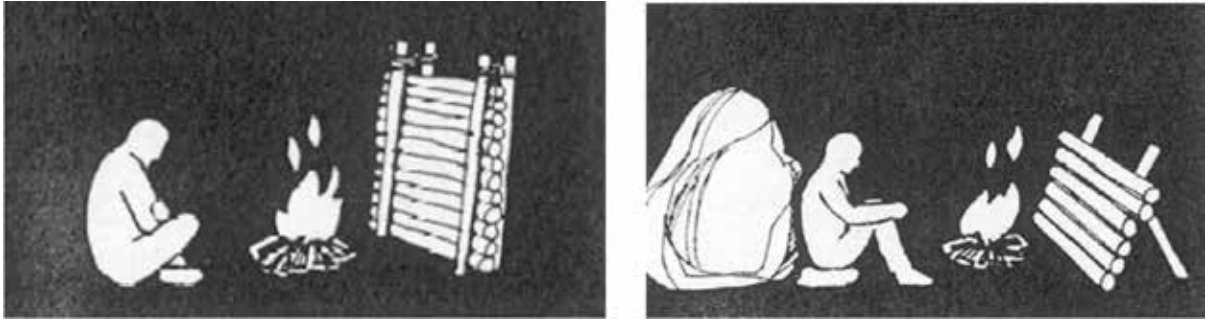

The SAS Survival Handbook, John Wiseman, 1986

Figure 8 Fire Wall Reflector

Drying Rack. A drying rack should be set up close enough to a fire to dry the wood, but not so close to ignite if struck by a spark. The two levels of the rack allow for adding more wet wood and still keeping them separate from the already drying wood.



The SAS Survival Handbook, John Wiseman, 1999

Figure 9 Drying rack

Wash Station (Ablutions). Wash stations may be constructed in a structure similar to one found in Figure 10. The dotted line indicates that you may attach cloth to add privacy.

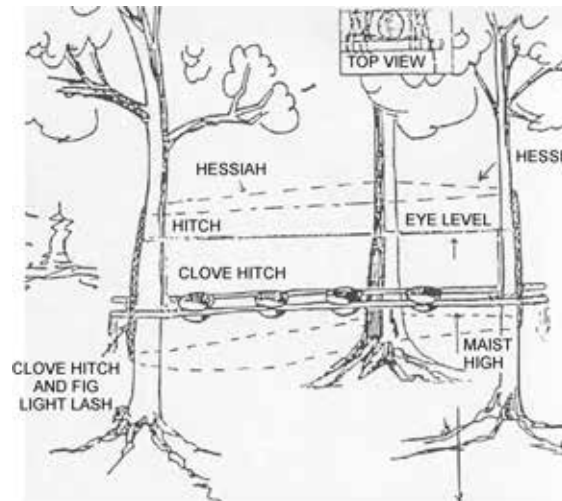

Field Aide-Memoire, Regional Cadet Instructor School, 1999

Figure 10 Ablutions Stand

ACTIVITY

OBJECTIVE

Cadets will construct suggested field amenities for a bivouac site using the knots and lashings learned to date.

RESOURCES

Cadets will be given:

- Adequate supply of rope.
- Natural resources, procured in the field, suitable for construction of field amenities.
- Diagrams of suggested construction for field amenities, found at Attachment A.
- Supervision.
- Minimal assistance as required.

ACTIVITY LAYOUT

- Cadets will be divided into groups of four and given a diagram of a field amenity introduced in this lesson. They will be given the resources listed above and a time limit of 100 minutes for preparation and construction of field amenities.



The cadets are to select and utilize the most appropriate of the knots and lashings presented in EO M121.03 (Section 3) and this EO to construct the field amenities.

SAFETY

Cadets will adhere to the following safety rules in the field:

- safe tools use;
- no running or horseplay;

- utilizing the buddy system at all times; and
- respecting established boundaries.

INSTRUCTOR GUIDELINES

While cadets construct field amenities, the instructor will monitor the groups and ensure the safety of cadets.



Cadets are reminded to adhere to the rules of no trace camping by utilizing felled wood and returning their environment to the way it was found. Field amenities may be constructed using logs, dead wood, etc.; however, these materials must be redistributed once the activity is completed.

END OF LESSON CONFIRMATION

The end of lesson confirmation will be accomplished through judging of the field amenities constructed. They will be judged for stability, quality of knots, and overall appearance.

CONCLUSION

HOMEWORK/READING/PRACTICE

Nil.

METHOD OF EVALUATION

Nil.

CLOSING STATEMENT

After learning how to enhance your base camp, you will be better prepared to enjoy your living space in the field. Field amenities can help the field feel like your home away from home.

INSTRUCTOR NOTES/REMARKS

Approval from local authorities shall be obtained prior to using natural resources for field amenities.

REFERENCES

A2-008 DCdts (1999). *RCIS Field Aide-Memoire* (1 ed.). Ottawa, ON: National Defence.

C2-007 (ISBN 0-7858-1446-9) Pawson, D. (2001). *Pocket Guide to Knots and Splices*. Edison, NJ: Chartwell Books, Inc.

C2-008 (ISBN 0-00-265314-7) Wiseman, J. (1999). *The SAS Survival Handbook*. Hammersmith, London: Harper Collins Publishers.

C2-016 (ISBN 0-517-88783-5) Curtis, R. (1998). *The Backpacker's Field Manual: A Comprehensive Guide to Mastering Backcountry Skills*. New York, NY: Three Rivers Press.

THIS PAGE INTENTIONALLY LEFT BLANK

CONSTRUCT FIELD AMENITIES

BEAR HANG

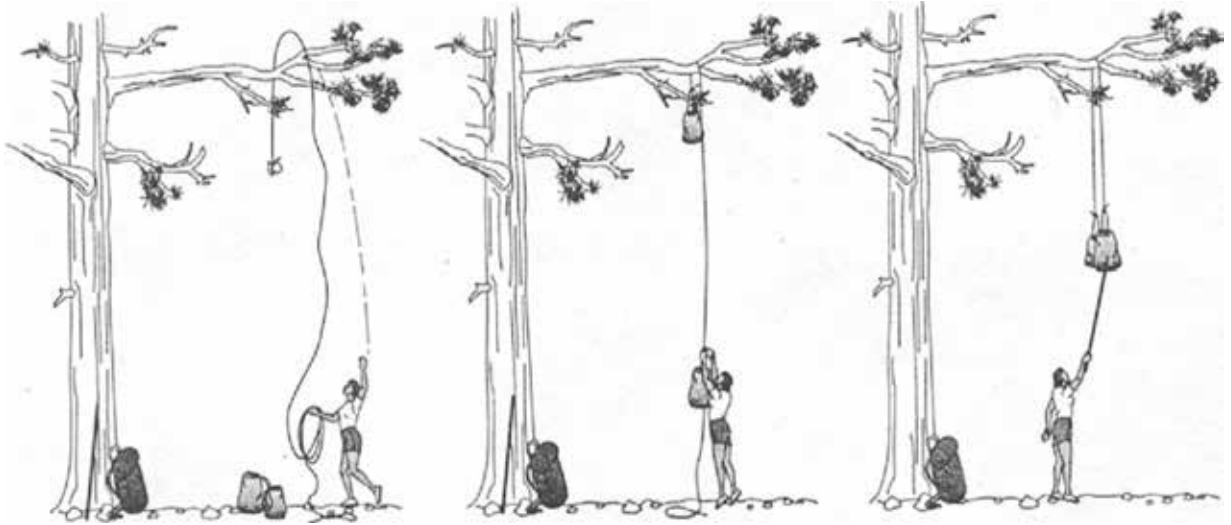

Instructions:

1. Find a tree with a live branch. The branch should be at least 15 feet (five metres) from the ground with no object below that a bear could stand on. When you throw the rope it should be more than 10 feet (three metres) from the tree.
2. Separate food from other items and store them into two equal bags.
3. Throw the rope over the branch. Attach one end of the rope to one of the bags with a slipped overhand knot.
4. Raise the bag as close as you can to the branch.
5. Attach the other bag to the rope as high up on the rope as you can. Leave a loop of rope near the bag for retrieval.
6. Push the second bag up to the level of the other bag with a long stick.
7. To retrieve the bags, hook the loop of the rope with the stick and pull it down. Remove the bag and then lower the first bag.

Safety:

- Make sure that no one is standing near when you are throwing or retrieving the bags.
- Do not place objects heavier than two pounds in each bag.
- Remember to distribute the weight of the two bags as best as you can.

Standard:

A proper bear hang should meet specifications above as close as possible. The instructor should be satisfied that the bag would be inaccessible to a bear. All knots and lashings will be assessed for neatness, proper appearance, and proper use for the knot.

FIRE WALL REFLECTOR



Instructions:

1. Cadets should find an area suitable for insulating heat, such as a rock in the diagram below.
2. If unable, there should be two walls to reflect the heat onto the people using it.
3. Attach two poles using a clove hitch, with about four to six inches in between to fill with smaller logs and wood found in the area.
4. As in the second diagram, the reflector wall may be on a slant and the logs lashed to the support beams also with a clove hitch.

Safety:

1. Cadets should be cautious moving through the woods, gathering materials to fill the walls. Make sure to utilize the buddy system.
2. Only use logs that you are physically able to carry.
3. Do not build anything high enough to fall on you if it topples.

Standard:

The reflector should be able to stand on its own without falling over, and must be built in a strategic place to reflect heat. All knots and lashings will be assessed for neatness, proper appearance, and proper use for the knot.



DRYING RACK

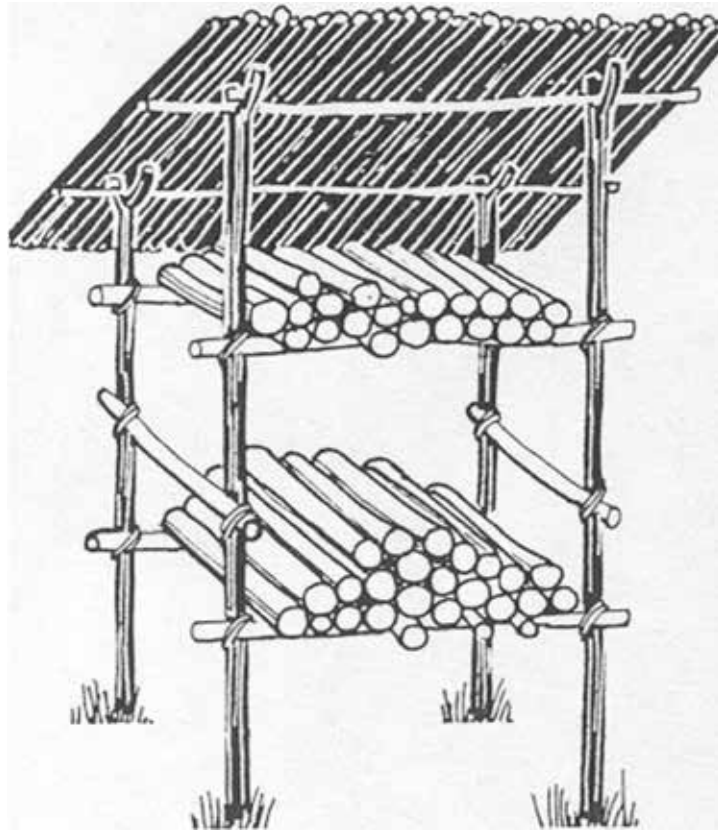

Instructions:

1. Find four sticks that have a branch close to the top so that it looks like a letter 'Y.'
2. Two of the sticks shall be shortened six inches. A bar will be placed between each set of sticks to hold a roof.
3. Use a half shelter or lash sticks of similar size, length, and thickness together to act as a roof for the wood shed. The roof will need to be as wide or wider than the base structure.
4. Lash a stick to each side of the structure and lay wood across to dry.
5. Add more sticks on the sides of the structure to add support or another shelf for wood.

Safety:

Place the roof on first before trying to raise the structure so it is less likely to fall and hurt anyone.

Standard:

The structure should be free standing, and able to hold wood on one or two levels, depending on the sophistication of the structure. All knots and lashings will be assessed for neatness, proper appearance, and proper use for the knot.

ABLUTIONS STAND

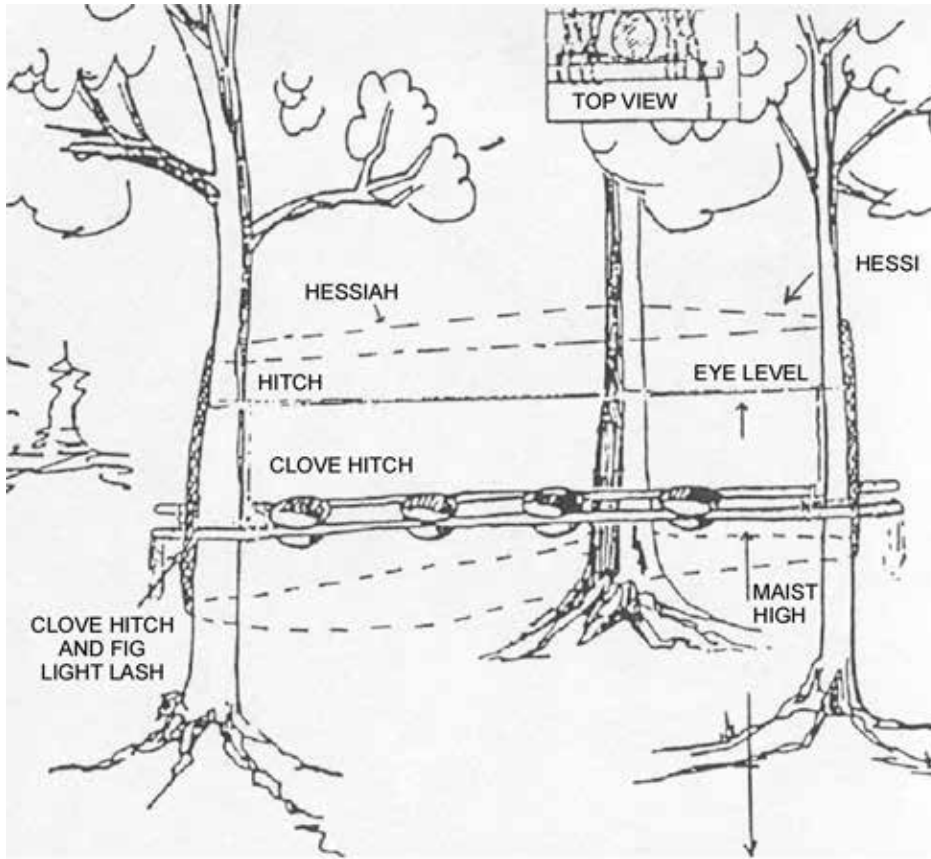

Instructions:

1. Locate three trees approximately eight to ten feet apart in a triangular formation. If a third tree is not available, improvise with a picket (a tall, sturdy stick to be used as a post).
2. Locate two sticks long enough to extend slightly past two of the three trees. These sticks will need to support four wash basins.
3. Lash one stick on each side of the trees at waist height using a clove hitch.
4. Construct four wash basin holsters by tying figure eight weaves in pairs. The lashings should be close enough to slide a wash basin in between.

Note: Ground sheets may be lashed to the outside of the tree formation to provide privacy for someone using the abluitions stand.

Safety:

1. Make sure that you only use logs that you are able to lift safely.
2. Logs should be braced at both ends while being tied and lashed to trees.

Standard:

The wash area should be able to support wash basins, and at a level that is reachable by everyone. All knots and lashings will be assessed for neatness, proper appearance, and proper use for the knot.



ROYAL CANADIAN ARMY CADETS
GREEN STAR
INSTRUCTIONAL GUIDE



SECTION 11

EO C121.02 – EXPLAIN THE EFFECTS OF COLD CLIMATE EXPOSURE

Total Time: 30 min

PREPARATION

PRE-LESSON INSTRUCTIONS

Resources needed for the delivery of this lesson are listed in the lesson specification located in A-CR-CCP-701/PG-001, *Green Star Qualification Standard and Plan*, Chapter 4. Specific uses for said resources are identified throughout the instructional guide within the TP for which they are required.

Review the lesson content and become familiar with the material prior to delivering the lesson.

PRE-LESSON ASSIGNMENT

Nil.

APPROACH

An interactive lecture was chosen to introduce the cadets to the effects of cold weather climate.

INTRODUCTION

REVIEW

Nil.

OBJECTIVES

By the end of this lesson, the cadets shall be expected to prepare themselves to participate in a cold weather Field Training Exercise (FTX).

IMPORTANCE

Training in cold climates provides unique challenges to ensure cadets are safe and healthy. The risk of exposure is greatly increased when individuals are unaware of the various risk factors. For that reason, every cadet should be familiar with cold weather risk factors prior to participating in cold weather training.

Teaching Point 1**Identify types of cold.**

Time: 5 min

Method: Interactive Lecture

TYPES OF COLD

- **Wet Cold.** Wet cold conditions occur when the temperature is close to the freezing point, with daytime temperature varying between freezing and thawing. Clothes need to be water resistant and wind repellent on the outer layer, and insulating and warm on the insulating layer. Waterproofing is essential.
 - **Dry Cold.** Dry cold conditions occur when the temperature is below -10°C , when the ground is usually frozen and the snow is dry. This type of cold is identified by a crunching sound when walking in the snow. Wind and cold temperatures mean that protection of the whole body is needed. Clothing needs to provide adequate insulation for the body, bringing the dead air surrounding the body to 18.3°C . This insulation layer must be covered by an outer layer which is water and wind repellent.
-

CONFIRMATION OF TEACHING POINT 1

QUESTIONS

- Q1. At what temperatures do wet cold conditions occur?
- Q2. What are some of the dry cold conditions?
- Q3. At what temperatures do dry cold conditions occur?

ANTICIPATED ANSWERS

- A1. Wet cold conditions occur when the temperature is above -10°C .
- A2. Dry cold conditions include frozen ground and dry snow.
- A3. Dry cold conditions occur when the temperature is below -10°C .
-

Teaching Point 2**Explain windchill effect on the human body.**

Time: 10 min

Method: Interactive Lecture

WIND CHILL AND ITS RELATED EFFECTS ON THE HUMAN BODY

Wind chill is defined as the number of calories lost during one hour from a square metre of a surface kept at neutral skin temperature (33°C). Wind chill is a measure of the combined effects of wind and temperature (See Figure 1).

Human comfort depends on the maintenance of a constant body temperature. When high winds are blowing, it feels much colder than when it is calm.

The lesson to remember is that thermometer readings alone will not give you a valid indication of the effects to be expected on the body. The wind chill scale is not strictly applicable as a measure of human comfort, as it does not take into account important factors such as activity, humidity, loss of heat in breath, radiation from the sun and the effects of lowered skin temperature.

		Temperature in Still Air								
		0	-5	-10	-15	-20	-25	-30	-35	-40
Wind Speed (km/h)	10	-2	-7	-12	-17	-22	-27	-32	-38	-45
	15	-5	-10	-16	-22	-28	-33	-39	-45	-51
	20	-7	-13	-19	-25	-31	-37	-43	-50	-57
	25	-10	-16	-23	-29	-36	-42	-49	-55	-62
	30	-11	-17	-24	-31	-37	-44	-50	-57	-65
	35	-12	-19	-26	-33	-40	-47	-54	-61	-68
	40	-13	-20	-27	-34	-41	-48	-55	-62	-70
	45	-14	-22	-29	-36	-44	-51	-57	-65	-73
	50	-15	-22	-30	-37	-44	-52	-59	-66	-74
	55	-16	-23	-31	-38	-46	-53	-60	-68	-75
	60	-16	-24	-31	-39	-46	-54	-61	-69	-77
		Minimal Danger			Dangerous Exposed flesh may freeze within one minute			Very Dangerous Exposed flesh may freeze within 30 seconds		

St. John Ambulance Official Wilderness First-Aid Guide, Wayne Merry, 1994

Figure 1 Wind Chill Chart

CONFIRMATION OF TEACHING POINT 2

QUESTIONS

- Q1. Wind chill is defined as the number of what lost, during one hour, from a square metre of a surface kept at neutral skin temperature?
- Q2. True or false? When high wind is blowing, the temperature can feel colder than it is.
- Q3. What are other factors that need to be taken into account with the wind chill?

ANTICIPATED ANSWERS

- A1. Number of calories.
- A2. True.
- A3. Factors include activity, humidity, loss of heat from breath no comma and radiation from the sun.

Teaching Point 3

Discuss the rules of cold weather training.

Time: 10 min

Method: Interactive Lecture

BASIC RULES OF COLD WEATHER TRAINING THAT ALLOW THE BODY TO ADJUST TO COLD CONDITIONS

The human body must be protected. To remain functional, it must be kept clean, dry and reasonably warm with normal body processes maintained. Rest and nutrition are vital.

Here are four basic rules to remember:

- **Keep in Shape.** Cold weather clothing is very heavy and can make you very tired when moving around in it. If you stay in shape, you will not become exhausted so quickly. A sleeping cadet will not freeze unless exhausted. You will awaken long before the danger point approaches.
- **Proper Hydration.** In winter, people generally do not drink enough water, as it is harder to come by. Dehydration leads to fatigue, so it is important to drink water even though you may not feel thirsty. This rule goes hand-in-hand with keeping active. As you do more activities to stay in shape, you have to replenish fluids lost through sweating. It is also important to mention that the wearing of heavy clothes leads to sweating which is not always noticeable to you. This sweating will lead to dehydration if not properly addressed.
- **Eating to Keep Fit.** Regular, hot food is essential to feeling your best and for top performance. Make sure you are eating, even if you do not feel hungry. It is important to eat three meals a day of as much hot food as you can. Healthy snacks, such as trail mix, between meals and before going to sleep will help generate body heat as the food is metabolized.
- **Maintain a Healthy Attitude.** Having a healthy attitude will help you survive longer in the cold. Keep alert and cheerful, and work hard. This combination will give you the right attitude. Training in cold weather can be difficult and uncomfortable, which can affect morale and mood. Having some patience, an open mind and some determination can allow you to enjoy many of the activities that the cold weather brings.

CONFIRMATION OF TEACHING POINT 3

QUESTIONS

- Q1. What are two of the basic rules for cold weather training that help the body adjust to the cold?
- Q2. Does severe exhaustion increase or decrease the chance of fatality in the cold?
- Q3. Should you drink water if you do not feel thirsty?

ANTICIPATED ANSWERS

- A1. Any two of the following:
- keep in shape;
 - proper hydration;
 - eat to keep fit; and
 - maintain a healthy attitude.
- A2. Increases.
- A3. Yes, you should drink water, even if you do not feel thirsty.



Remember – Cold weather will make tasks harder and they may take longer, but it does not make them impossible. With the right equipment and training, you can beat the cold.

END OF LESSON CONFIRMATION

Confirmation is best achieved by going outside and reviewing the conditions; however, if the weather is not appropriate, the end of lesson confirmation could be any of the following questions:

QUESTIONS

- Q1. At what temperature do wet cold conditions occur?
- Q2. What are some of the characteristics of dry cold conditions?
- Q3. Wind chill is defined as the number of what lost during one hour from a square metre of a surface kept at neutral skin temperature?
- Q4. True or false? When high wind is blowing, it can feel colder than it is.
- Q5. Should you drink water if you do not feel thirsty?

ANTICIPATED ANSWERS

- A1. Wet cold conditions occur when the temperature is above 14°F.
- A2. Cold conditions include frozen ground and dry snow.
- A3. Number of calories.
- A4. True.
- A5. Yes.



The instructor may choose to write down each of the questions on a piece of paper and place them into a bag. The cadets can then be divided into pairs (if the group is large), and each individual (or group) then picks a piece of paper out of the bag. The cadet should read the question and provide the answer to the rest of the group.

CONCLUSION

HOMEWORK/READING/PRACTICE

Nil.

METHOD OF EVALUATION

Nil.

CLOSING STATEMENT

Remember: You can coexist with the cold *if* you are prepared and take care of yourself by following the basic rules of training in cold weather.

INSTRUCTOR NOTES/REMARKS

This period may be conducted as a stand alone lesson or as pre-training to EO C121.05 (Participate in Cold Weather Training).

This lesson is best delivered under the supervision of a cold weather instructor.

REFERENCES

A2-009 A-CR-CCP-107/PT 002 DCdts. (1978). *Royal Canadian Army Cadets Course Training Plan Corps Training Program Winter Adventure Training Manual*. Ottawa, ON: National Defence.

C2-029 The Green Lane. (2002, 2005). *Windchill*. Retrieved 25 May 2006, from <http://www.msc.ec.gc.ca/windchill>.



ROYAL CANADIAN ARMY CADETS
GREEN STAR
INSTRUCTIONAL GUIDE



SECTION 12

EO C121.03 – SELECT COLD WEATHER CLOTHING

Total Time: 30 min

PREPARATION

PRE-LESSON INSTRUCTIONS

Resources needed for the delivery of this lesson are listed in the lesson specification located in A-CR-CCP-701/PG-001, *Green Star Qualification Standard and Plan*, Chapter 4. Specific uses for said resources are identified throughout the instructional guide within the TP for which they are required.

Review the lesson content and become familiar with the material prior to delivering the lesson.

PRE-LESSON ASSIGNMENT

Nil.

APPROACH

An interactive lecture was chosen for this lesson to introduce the cadets to the selection of cold weather clothing.

INTRODUCTION

REVIEW

The pertinent review of EO M121.01 (Section 1) for this lesson will include:

QUESTIONS

- Q1. What are the three layers that make up the layering system?
 Q2. What is a good material to use for base layer clothing?

ANTICIPATED ANSWERS

- A1. Base layer, insulating layer, outer layer.
 A2. Polypropylene.

OBJECTIVES

By the end of this lesson, the cadet shall be expected to know how to select clothing for cold weather.

IMPORTANCE

Cadets need to know how to select the best types of clothing that will enable them to enjoy winter conditions and prevent cold weather injuries.

Teaching Point 1**Explain the principles of clothing design.**

Time: 10 min

Method: Interactive Lecture

PRINCIPLES OF CLOTHING DESIGN

The human body must always maintain a temperature of 37°C. Clothing acts as an insulator, preventing body heat from escaping to the outside air.

Cold weather clothing must provide insulation and, at the same time, ventilation to prevent overheating and allow sweat to evaporate. The two primary considerations when dressing for the cold are; insulation and layer method.

- **Insulation.** Insulation is provided by any material that restricts the transfer of heat. Dry air is both light and an excellent insulator. Materials that hold quantities of motionless, or dead air are the best insulators. These include natural materials such as wool and fur and synthetic materials such as the popular polar fleece.
- **Layer Method.** The principles of the layer method of insulating the body for a cold climate include:
 - The next to skin layer should be of a suitable material to wick perspiration away from the skin and allow it to evaporate.
 - Several layers of medium weight clothing will keep a person warmer than one heavy garment, even if it is as thick as the combined layers. Layers trap dead air, therefore resisting the passage of heat out of the body.
 - Inner garments should be more porous, therefore having more air pockets, while the outer layers are more wind and water resistant. The outer garments prevent the outside cold air from displacing your trapped, body-warmed, still air.
 - Layering allows you to adjust the amount of clothing being worn for a wide range of temperatures and activities by merely adding or removing a layer of clothing at a time. You have the ability to help control the balance of body heat.
 - The outer layer must allow moisture from perspiration to escape while retaining warmth. In a dry cold this material does not need to be water resistant but must be wind resistant.
 - When properly dressed you should feel cool, but not cold.

CONFIRMATION OF TEACHING POINT 1

QUESTIONS

- Q1. What are two examples of insulating materials?
- Q2. Which is warmer, several medium weight layers, or one thick layer of clothing?
- Q3. Outer layers should be resistant to what?

ANTICIPATED ANSWERS

- A1. Wool and fur.
- A2. Several medium layers of clothing.
- A3. Wind and water.

Teaching Point 2**Explain the principles related to the choice of footwear.**

Time: 5 min

Method: Interactive Lecture

PRINCIPLES VALUABLE IN CHOICE AND USE OF FOOTWEAR

Feet are vulnerable to the cold because they get wet easily, both externally and from perspiration.

The following principles are valuable when choosing and wearing footwear:

- **Ensure Footwear is Loose and in Layers.** The layers are made up by the boot and the different combinations of socks and insoles.
- **Avoid Restriction of Circulation.** Two or more pairs of socks worn too tightly or tying the boot too tightly can restrict the circulation of warm blood from the body core and allow for freezing of the feet.
- **Change Socks and Insoles as Often as Possible.** Since footwear often gets wetter than other types of equipment, select footwear designed to help decrease this (e.g. with a rubber lower and material upper). Dry socks should always be carried, and socks should be changed as soon as possible when they become wet. If wearing heavy footwear equipped with removable insoles, such as mukluks, both socks and insoles should be changed.
- **Dry Footwear When Wet.** Footwear should be dried thoroughly at the first opportunity available to you.
- **Ensure Footgear and Feet are Kept Clean.** Footgear should be kept clean of mud and dirt, and feet should be cleaned frequently. Feet should always be exercised and massaged when changing socks.
- **Ensure All Footwear Fits Properly to Avoid Chafing and Blisters.** Ski and snowshoe bindings must be adjusted carefully. Improperly adjusted bindings may chafe the feet or cause excess wear and tear to the boot.

CONFIRMATION OF TEACHING POINT 2

QUESTIONS

- Q1. What are considered to be layers in footwear?
- Q2. How often should you change socks?
- Q3. What happens when two pairs of socks are worn too tightly?

ANTICIPATED ANSWERS

- A1. Boots, socks and insoles.
- A2. As often as possible, and as soon as they become wet.
- A3. They can restrict circulation and cause feet to freeze.

Teaching Point 3**Explain the principles for keeping warm in the cold.**

Time: 5 min

Method: Interactive Lecture

PRINCIPLES FOR KEEPING WARM IN THE COLD

Principles for keeping warm in the cold can be remembered using the acronym COLD:

C – Clean Clothing. Important for both sanitation and comfort. Dirt and grease will fill air pockets in clothes and allow the heat to escape your body more easily, leaving you feeling cold sooner.

O – Overheating must be avoided. Overheating causes perspiration, which causes clothing to become damp. Dampness fills the air pockets in the clothing with heat-conducting moisture, permitting the body heat to escape. Overheating can be prevented by ventilation or removing layers.

L – Loose and in **Layers**. Clothes and footwear that are too tight restrict the blood circulation, increasing the danger of frostbite. Clothes should not be too loose either, as this allows trapped air to move, causing heat loss. Layering allows you to take clothing off before you overheat and add clothing as you cool.

D – Keep clothes Dry. Moisture will soak into your clothes from both inside and outside. Frost or snow that collects on your clothes will melt, making your clothes wet.



To stay warm, remember the catch word “**COLD**”.

CONFIRMATION OF TEACHING POINT 3

QUESTIONS

- Q1. What does the acronym COLD stand for?
- Q2. Why should your clothes be clean?
- Q3. Why should clothes be in layers?

ANTICIPATED ANSWERS

- A1. Clean clothes, avoid overheating, loose layers, and dry clothes.
- A2. Clothes should be clean so dirt and grease do not fill the air pockets, allowing air to flow around the body.
- A3. When clothes are worn in layers, they can be added and removed depending on how warm you are.

Teaching Point 4

Discuss maintaining body heat.

Time: 5 min

Method: Interactive Lecture

MAINTAINING BODY TEMPERATURE

As said previously in this lesson, the body has to maintain a certain body temperature. The body does this in two ways: heat gain and heat loss.

Heat Gain. The body increases heat production in two ways:

- **Muscular.** Heat is generated within the body by muscles performing physical work. When cool, the body will resort to shivering, which consists of uncontrolled, irregular, and uncoordinated contractions of voluntary muscles. Unlike animals, humans do not have any special features of the body that allow them to gain heat in cold weather. We do have brains though, and through physical activity, special clothing, shelter and an ability to build a fire, people can help maintain normal body temperature in a cold weather climate.
- **Metabolic.** Heat production to tissues may be increased by metabolic chemical reactions taking place, mostly in the liver, but is not significant enough to warm the entire body. The human body is like a car, and food is your fuel. Some foods are better for you than others. Carbohydrates give great boosts of energy to do more physical activity. It is important to eat three meals a day and snacks in between meals

as well as when you feel hungry. Eating nutritious food and lots of water, allows the body to work to its maximum potential.

Heat Loss. The body naturally cools itself down by sweating. Approximately 90 to 95 percent of heat is expelled through the skin, and the remainder is expelled through the lungs during respiration.

Body heat is lost from the skin in four ways (see Figure 1):

- **Convection.** Occurs when air, or water that has a temperature below that of the body, comes into contact with the skin and subsequently moves away. While in contact with the body, the air is warmed. Cool air that replaces it must also be warmed. The heat that warms the air is lost whenever the air moves away. The greater the difference in temperature between the body surface and the speed with which the air is moving, the greater the heat loss.
- **Conduction.** Is the transfer of heat energy away from the body by substances with which it is in direct contact. Air conducts heat poorly and still air, which does not cause convective heat loss, is an excellent insulator.
- **Evaporation.** With heavy sweating, also comes insensible sweating. Insensible sweating can happen in cold weather as well as warm weather. Cold air is dry and has to be moistened by the body to avoid injuring the lungs.
- **Radiation.** Largest source of heat loss, it consists of the direct emission or absorption of heat energy. The human body continuously radiates heat to nearby solid objects that have a cooler temperature. In a cold environment, nearby solid objects are colder and radiant heat loss is greater.

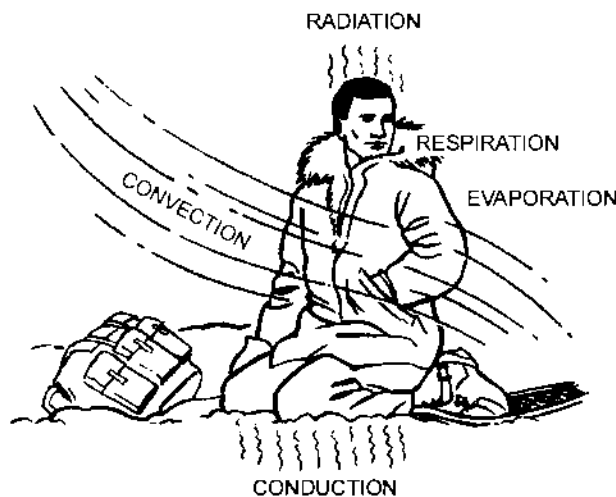

<http://brooksidepress.org/Products/Operationalmedicine/DATA/operationalmed/Manuals/cold/TC213Chapter6HygieneandFirstAid.htm>

Figure 1 Mechanisms of Heat Loss From the Body

CONFIRMATION OF TEACHING POINT 4

QUESTIONS

- Q1. What are the two ways the body maintains normal temperature?
- Q2. What is an involuntary movement the body does to gain heat when it is losing it?
- Q3. What are the four ways in which the body loses heat from the skin?

ANTICIPATED ANSWERS

- A1. Heat loss and heat gain.
- A2. The body involuntarily shivers.
- A3. The body loses heat through convection, conduction, evaporation, and radiation.

END OF LESSON CONFIRMATION

QUESTIONS

- Q1. Which is warmer, several medium weight layers or one thick layer of clothing?
- Q2. How often should you change your socks?
- Q3. What does the acronym COLD stand for?

ANTICIPATED ANSWERS

- A1. Several medium layers of clothing.
- A2. As often as possible, and as soon as they become wet.
- A3. Clean Clothes, avoid Overheating, Loose Layers, and Dry clothes.

CONCLUSION

HOMEWORK/READING/PRACTICE

Nil.

METHOD OF EVALUATION

Nil.

CLOSING STATEMENT

You can enjoy winter activities and training if you know how to select the proper clothing and take care of yourself by being prepared for the elements.

INSTRUCTOR NOTES/REMARKS

This period may be conducted as a stand alone lesson or as pre-training to EO C121.05 (Participate in Cold Weather Training).

This lesson is best delivered under the supervision of a cold weather instructor.

REFERENCES

A2-009 A-CR-CCP-107/PT 002 DCdts. (1978). *Royal Canadian Army Cadets Course Training Plan Corps Training Program Winter Adventure Training Manual*. Ottawa, ON: National Defence.

C2-031 (ISBN 0-89886-024-5) Wilkerson, J., Bangs, C., and Hayward, J. (1986). *Hypothermia, Frostbite and Other Cold Injuries. Prevention, Recognition and Prehospital Treatment*. Seattle WA: The Mountaineers.

C2-037 Brookside Press. (2005). *Hygiene in the Field*. Retrieved 25 May 2006, from <http://brooksidepress.org/Products/Operationalmedicine/DATA/operationalmed/Manuals/cold/TC213Chapter6HygieneandFirstAid.htm>.



ROYAL CANADIAN ARMY CADETS
GREEN STAR
INSTRUCTIONAL GUIDE



SECTION 13

EO C121.04 – RECOGNIZE THE EFFECTS OF COLD WEATHER

Total Time: 60 min

PREPARATION

PRE-LESSON INSTRUCTIONS

Resources needed for the delivery of this lesson are listed in the lesson specification located in A-CR-CCP-701/PG-001, *Green Star Qualification Standard and Plan*, Chapter 4. Specific uses for said resources are identified throughout the instructional guide within the TP for which they are required.

Review the lesson content and become familiar with the material prior to delivering the lesson.

PRE-LESSON ASSIGNMENT

Nil.

APPROACH

An interactive lecture was chosen for this lesson to introduce the cadets to the effects of cold weather.

INTRODUCTION

REVIEW

The pertinent review for this lesson will include:

QUESTIONS

- Q1. What layers make up the layering system?
- Q2. What would be a good base layer material?
- Q3. Name two benefits of the self-inflating pads.

ANTICIPATED ANSWERS

- A1. Base layer, insulating layer, and outer layer.
- A2. Polypropylene.
- A3. Very comfortable, warmer, lightweight and better thermal insulation.

OBJECTIVES

By the end of the lesson the cadet shall be expected to recognize the effects that cold weather can have on the body, and how to treat and prevent cold-related injuries and conditions.

IMPORTANCE

Cadets need to know how to prevent, recognize, and treat cold weather injuries. Knowing how to properly identify various cold-related injuries and taking proper preventative measures will ensure a safe, fun, and meaningful training experience in cold weather.



While the cadet will learn to prevent, recognize and treat basic cold weather injuries and conditions, it is to be made clear that immediate reporting to an adult supervisor or senior cadet should be the first action if there is ever any question or concern.

Teaching Point 1**Discuss facts about injuries that occur in cold weather.**

Time: 10 min

Method: Interactive Lecture

FACTS ABOUT INJURIES THAT OCCUR IN COLD WEATHER

Bleeding. Wounds bleed easily in cold weather because the low temperature prevents the blood from clotting. Increased bleeding increases the chance of going into shock. Also, wounds open to the cold weather will freeze quickly. The body loses heat around the wound as blood soaks the skin. Further, the clothing is usually torn around an open wound, allowing for further heat escape.

Shock. Shock is a condition that is caused by the reduction of effective circulation blood volume. It can be caused by a number of things including severe injuries, loss of blood and pain. The normal reaction of the body to severe cold is very similar in its reaction to shock. Therefore, shock will develop more rapidly and progress more deeply in extreme cold than in normal temperatures. Signs of shock include apprehension, sweating, thirst, pale skin, faint and rapid pulse, and cold and clammy skin.

Serious Injuries. Just like training in warm weather, medical attention should be sought for all serious injuries such as; broken limbs, deep or severe lacerations, respiratory illnesses, etc.



Signs are things that you can **see** on the victim. Symptoms are things that the victim **tells** you they feel.

CONFIRMATION OF TEACHING POINT 1**QUESTIONS**

- Q1. Why do wounds bleed more easily in cold weather?
 Q2. What are some signs of shock?
 Q3. Is pale skin a sign or a symptom?

ANTICIPATED ANSWERS

- A1. The cold weather prevents blood from clotting.
 A2. Any of the following: apprehension, sweating, thirst, pale, faint, rapid pulse, and cold clammy skin.
 A3. Pale skin is a sign. It can be seen by an observer.

Teaching Point 2**Identify cold weather injuries.**

Time: 10 min

Method: Interactive Lecture

COLD WEATHER INJURIES

Snow Blindness. Snow blindness is caused by the infrared or ultra-violet rays reflecting from a snow covered surface. These rays, unlike visible light rays, are readily absorbed by clear or coloured glass. Snow blindness is greatest on dull, cloudy days or when crystalline snow mist is present. Resting in darkness is the best treatment. Symptoms usually appear within six to eight hours, and include an irritating feeling in the eyes, blurred vision, pain, and the eyes feeling hot and sticky.

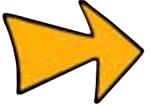

Most minor cases of snow blindness will recover within 18 hours without medical attention. A severe case may take three to four days to recover.

Immersion Foot. A cold injury resulting from exposure to temperatures near freezing. The temperature does not have to be below 0°C for it to occur. In the early stages, the feet and toes are pale and feel cold, numb, and stiff. Often walking becomes difficult. If no treatment is given, the feet will swell and become very painful. In extreme cases the flesh dies, and amputation is needed.



It is difficult to feel immersion foot in the early stages. In order to assist in prevention of immersion foot, be sure to keep feet clean and dry, checking them often. Rub and massage them when changing socks.

CONFIRMATION OF TEACHING POINT 2

QUESTIONS

- Q1. When do symptoms of snow blindness usually appear?
- Q2. What causes immersion foot?
- Q3. What are some serious injuries that will require medical attention?

ANTICIPATED ANSWERS

- A1. Symptoms of snow blindness usually appear in six to eight hours.
- A2. Immersion foot is caused by exposure to temperatures near freezing.
- A3. Severe lacerations, respiratory difficulties, and broken limbs are some serious injuries.

Teaching Point 3

Explain frostbite.

Time: 10 min

Method: Interactive Lecture

FROSTBITE

Frostbite is the freezing of tissue in the body. As blood flow slows down, the fluid between cells can freeze. As ice crystals form on them, the cells become dehydrated. Frostbite acts locally on parts of the body such as fingers, toes, chin, nose and ears. It is a constant hazard during activities occurring in sub-zero temperatures, especially when accompanied by strong winds.

Signs and symptoms of frostbite stages:

Surface Frostbite. Also known as superficial frostbite or frostnip, it affects only the outer layer of skin and causes little damage. It may result from direct contact with cold metal or severe wind chill. After the nipped area is warmed, the layer of frozen skin becomes red, and after a few days, the skin will peel, looking similar to sunburn. Signs and symptoms include:

- skin turns white and numb;
- tissues beneath the affected area are still soft;

- casualty may not feel it; and/or
- partner may notice a white spot.

Deep Frostbite. Frostnip has progressed into underlying tissue. It may feel hard on the surface, and soft below. Blisters will usually appear within 24 hours of warming. It needs proper warming, not just an application of heat. If it progresses even further, the injury extends into deeper tissue and into the muscle. Blisters containing fluid, blood-filled blisters, delayed blisters or lack of blisters forming within 48 hours of warming indicate deep frostbite. It may cause loss of tissue and permanent damage, including the loss of parts, or all of the affected area (e.g. hands). Proper field care can often mean the difference between temporary disabilities and permanent injuries. Signs and symptoms include:

- pain or numbness in the fingers, toes, heels, and entire hands and feet;
- tissue is hard all around the affected area;
- the frostbitten part is cold and white (sometimes purple); and/or
- no pain, or feeling of any kind, in the extremity that is frozen.

PREVENTION

Surface. Is common on the face, and is associated with naturally occurring wind, or wind from a moving vehicle. A good parka tunnel will usually prevent frostbite because it holds a pocket of warm air around the face. In strong winds, cover nose and cheeks with a facemask, scarf, or any piece of warm fabric. Since frostbite is often not felt, the first warning may come from a companion who notices a white spot on your face. Frostbite is also common on the hands if doing work, or if coming into contact with cold metal.

Deep. Often occurs when exposed to freezing temperatures with no chance to warm up, or when hands and feet become wet and freeze. It is important to eat often to maintain body warmth, drink often to avoid dehydration, and rest enough to avoid fatigue while restoring circulation. Warm numb and painful feet immediately.

TREATMENT

Do not use snow, oil, rubbing, massage or pressure.

Surface. Serves as a warning. A frozen nose is the most common type of a surface frostbite. Most minor surface frostbite can usually be thawed using body heat. Place a warm palm against a frostbitten cheek or ear, and place frostbitten hands against your chest, between your thighs, or under your arm pits. Surface frostbite that produces blisters may require evacuation for medical attention.

Deep. Remove all constricting clothing such as boots, gloves or socks, without causing further damage to the frostbitten area. The frozen part should be placed against an unfrozen part of the body or exposed to warm air. Rapid thawing by the application of external heat is the safest way to relieve frostbite. Clean and dress the area to avoid infection. Do not exercise the injured person, or warm them in front of open fire. Do not allow the frostbitten part to become frozen again. Evacuate for medical attention.

CONFIRMATION OF TEACHING POINT 3

QUESTIONS

- Q1. What are the two stages of frostbite?
- Q2. What layer of skin is frozen if you have surface frostbite?
- Q3. What is the most common body area affected by surface frostbite?

ANTICIPATED ANSWERS

- A1. Surface and deep.
- A2. Only the outer layer of the skin.
- A3. A frozen nose.

Teaching Point 4

Explain hypothermia.

Time: 10 min

Method: Interactive Lecture

SIGNS AND SYMPTOMS OF HYPOTHERMIA

Cold exposure, or hypothermia, is the cooling of the body's core temperature. Exposure can be divided into three levels – mild, moderate and severe. It is hard to tell where one level starts and the next stops without a special thermometer.

Signs and symptoms of hypothermia stages:

Mild Exposure. During mild exposure the casualty:

- is awake;
- shivering;
- can answer questions intelligently;
- may be slurring their speech;
- is losing interest in what they are doing; and
- is complaining that they are cold.

Moderate Exposure. During moderate exposure the casualty:

- is confused and illogical;
- does not want to move much, and may be sleepy;
- is clumsy and stumbles;
- stops shivering;
- shows signs of muscle stiffness;
- has slow breath and pulse rates;
- may have a fruity odour to breath;
- may have dilated pupils; and
- may urinate in clothing.

The casualty is in great danger and is close to severe hypothermia, unconsciousness and death.

Severe Exposure. Moderate exposure quickly becomes severe exposure. At this point the casualty is in a coma, and is close to death. In severe exposure, the casualty:

- is barely conscious;
- has slow, shallow breathing and a weak, slow, irregular or absent pulse; and
- has pale, very cold, perhaps bluish skin.

During this time, the casualty will appear dead. It is important to remember, that though they may look dead, there still may be an undetectable pulse, and some respiration. You can not determine if someone is dead until the body has warmed up and there is still no sign of life.

PREVENTION

There are a number of things a person can do to help prevent exposure.

- Prepare for the worst and take extra clothing.
- Avoid overheating and sweating. Wear loose, layered clothing that breathes. Cotton wets easily and dries slowly. Wool is warm, even when wet. Modern fabrics such as polypropylene and polyester are superior next to the skin.
- Avoid long term cooling. The effects of cold exposure are cumulative, making long term exposure dangerous. Take breaks for hot drinks, and try to get out of the wind. Do not continue on if you are getting seriously cold.
- Eat often to provide fuel for your body. It is important, in addition to the main meals provided to you during winter training activities, to have healthy, high-energy snacks for consumption between meals. Food items such as trail mix (nuts, fruits, grains) will burn longer in the body, providing a more sustainable energy level for cadets. Items like chocolate are metabolized too quickly, and will lead to a cadet “crashing”, or running out of energy too soon.
- Drink lots. Dehydration is a major contributor to exposure. Hot, sweet drinks are best, but you can also drink cold water. Do not eat snow if you are cold, as it may contribute to lowering your body’s temperature even farther.
- Keep your big muscles moving. This creates heat. Keep wiggling your toes and fingers if they are cold. Wiggling them will not warm you up too much, but moving the larger muscles of the arms and legs will. Swing your arms vigorously, stamp your feet, and place the hands in the armpits.
- Check your companions often. If they get clumsy, start to shiver, slur their speech, or act strangely, you can suspect exposure. Remember that people suffering from exposure do not always feel it.

TREATMENTS

Mild Exposure. If you think that your companion is suffering from mild exposure, you should:

- stop travelling;
- prevent any further loss of body heat;
- get them into shelter;
- replace any wet clothing;
- allow shivering to continue as it is the body trying to warm up; and
- give them food and hot drinks.

Re-warming with skin-to-skin contact or sleeping bags is the best way to help the person.

Moderate Exposure. If the casualty is suffering from moderate exposure, treat them for mild exposure, except:

- avoid rough handling and do not let them walk;
- do not give fluids to drink until they are awake, and understand what is going on. This will prevent choking; and
- seek medical attention.

Never handle anyone in moderate exposure roughly, or allow them to move much, as this affects the heart and can cause it to fail quickly.

Severe Exposure. There must be medical treatment at this time. There is some treatment that you can give to a casualty showing signs of severe exposure. They are:

If there is any breathing or a pulse, you should:

- handle the casualty very gently;
- prevent further heat loss; and
- move them gently to medical care.

If medical attention is not available, and you are far from help, you should:

- immediately and gently move them into warm shelter;
- apply heavily wrapped warm water bottles to sides of their neck, chest and groin. Do not put them anywhere else; and
- keep them warm and let them recover very slowly without moving them.

It is very important that the water bottles be only slightly warm, as too much heat will damage the skin. Do not rub the hands, feet or legs or move them if you do not have to. If the casualty recovers, the hearing is the first to return, then the sight. They may lose control of their bowels.

CONFIRMATION OF TEACHING POINT 4

QUESTIONS

- Q1. What are the three types of exposure?
- Q2. What are some things you can do to prevent exposure?
- Q3. What is the best way to re-warm someone with mild exposure?

ANTICIPATED ANSWERS

- A1. Mild, moderate and severe.
- A2. Any of the following: take extra clothing, avoid sweating and long term cooling, eat often, drink lots, keep active, and check each other often.
- A3. Skin-to-skin contact or a sleeping bag.



Though a person may look like they are dead, they may still be breathing, and need medical attention immediately.

Teaching Point 5**Discuss winter hygiene.**

Time: 10 min

Method: Interactive Lecture

BODY CLEANLINESS

To stay healthy on cold weather exercises, it is important to keep clean. While the body tries to stay warm, perspiration can clog pores in the skin and the clothes, making you feel colder. It is not always easy to properly clean yourself, because of the lack of sanitary facilities, but there are some rules that will keep you healthier and feeling better longer.

Washing. Wash your face and hands daily. Though there are no baths around, you should try to wash your feet, crotch and armpits at least twice a week - and more often if possible. These are areas where most of the heat of the body is lost; therefore, there is more perspiration in these areas.

Shaving. Shave every day. It is best to do it before bed as the body is warmer and it should be easier. Shaving in the morning may also strip the skin of essential oils.

Teeth. Teeth should be cleaned daily. If you do not have a toothbrush, wrap gauze around your finger and rub over your teeth. Cleaning the teeth will help prevent germs from growing as well as make you feel better.

Changing Clothes. Underwear and shirts should be changed at least twice weekly. If not, then they should be crumpled, shaken out, and aired out for about two hours. As clothes become dirty, warm air is not able to circulate around the body, increasing your chances of overheating.

Foot Care. Socks should be changed and feet washed as often as possible, but at least twice a week. Boots and socks should be removed every night and the feet massaged and dried. Use foot powder if you have it.

BODY FLUIDS

In order to keep the body in the healthiest and cleanest state for winter camping, you must drink plenty of fluids. Dehydration is one of the largest contributors to cold-related illnesses such as exposure. The body loses a lot of fluid through evaporation, conduction, respiration, radiation and convection. The fluid must be replaced so the body is able to function effectively in the cold weather.

The body needs to expunge bodily fluids such as urine, and waste, on a regular basis to maintain its healthy state.



Keeping clean will make you feel more comfortable and help motivate you to train and enjoy the activities associated with training in cold weather.

CONFIRMATION OF TEACHING POINT 5

QUESTIONS

- Q1. How often should you wash your hands?
- Q2. Why must you drink plenty of fluids while in cold weather?
- Q3. True or false: Cadets will use the washroom less often in the winter.

ANTICIPATED ANSWERS

- A1. You should wash your hands daily.
- A2. You have to drink lots of fluids to replace the ones your body has lost.
- A3. False. A cadet will still need to go the bathroom as often as they normally would.

END OF LESSON CONFIRMATION



The instructor may choose to utilize an activity where the cadets will be given a card detailing a sign or symptom of an environmental injury or condition. The cadet will then, as a means of confirming understanding of the material, act out the illness associated with the sign or symptom on the card. This will demonstrate an understanding on the part of the cadet acting out the associated ailment, as well as gauge the understanding of the cadets required to guess the injury or condition.

Alternately, the following questions can be asked.

QUESTIONS

- Q1. What are some signs of shock?
- Q2. When do symptoms of snow blindness usually appear?
- Q3. What causes immersion foot?
- Q4. What are some serious injuries that will require medical attention?
- Q5. What layer is frozen when you have superficial frostbite?
- Q6. What is the most common body area affected by superficial frostbite?
- Q7. What are the three types of exposure?
- Q8. What are some things you can do to prevent exposure?
- Q9. What is the best way to re-warm someone with mild exposure?
- Q10. How often should you wash your hands?

ANTICIPATED ANSWERS

- A1. Any of the following: apprehension, sweating, thirst, pale skin, faint, rapid pulse, and cold, clammy skin.
- A2. Symptoms of snow blindness usually appear in six to eight hours.
- A3. Immersion foot is caused by exposure to temperatures near freezing.
- A4. Severe lacerations, respiratory difficulties, and broken limbs are some serious injuries.
- A5. Only the outer layer of the skin.
- A6. A frozen nose.
- A7. Mild, moderate and severe.
- A8. Any of the following: take extra clothing, avoid sweating and long term cooling, eat often, drink lots, keep active, and check each other often.

A9. Skin-to-skin contact or a warm blanket.

A10. You should wash your hands daily.

CONCLUSION

HOMEWORK/READING/PRACTICE

Nil.

METHOD OF EVALUATION

Nil.

CLOSING STATEMENT

Every year people are injured, including dying of exposure, because they don't recognize the risk factors and the signs and symptoms of cold weather injuries in time to prevent the injury. Cadets can be proactive in the recognition of signs and symptoms and can protect their buddies from injury by being aware that anyone, even an officer, can suffer a cold weather injury.

INSTRUCTOR NOTES/REMARKS

This period may be conducted as a stand alone lesson or as pre-training to EO C121.05 (Participate in Cold Weather Training).

This lesson is best delivered under the supervision of a cold weather instructor.

REFERENCES

A2-010 B-GG-302-002/FP-001 FMC. (1982). *Basic Cold Weather Training, Arctic and Sub Arctic Operations* (Vol. 2). Ottawa, ON: National Defence.

C2-009 (ISBN 0-684-85909-2) Harvey, M. (1999). *The National Outdoor Leadership School's Wilderness Guide*. New York, NY: Fireside.

C2-023 (ISBN 0-8117-2864-1) Schimelpfenig, T. (2000). *National Outdoor Leadership School Wilderness First Aid (3rd ed.)*. Mechanicsburg, PA: Stackpole Books.

C2-030 (ISBN 0-7710-8250-9) Merry, W. (1994). *St. John Ambulance the Official First Aid Guide*. Toronto ON: McClelland & Stewart Inc.

THIS PAGE INTENTIONALLY LEFT BLANK



ROYAL CANADIAN ARMY CADETS
GREEN STAR
INSTRUCTIONAL GUIDE



SECTION 14

EO C121.05 – PARTICIPATE IN COLD WEATHER TRAINING

Total Time:

18 x 30 min

No instructional guide is provided for this EO, refer to A-CR-CCP-107/PT-002, *Royal Canadian Army Cadets Course Training Plan, Corps Training Program, Winter Adventure Training Manual*, for activities.

THIS PAGE INTENTIONALLY LEFT BLANK

CHAPTER 12

PO 122 – IDENTIFY LOCATION USING A MAP



ROYAL CANADIAN ARMY CADETS
GREEN STAR
INSTRUCTIONAL GUIDE



SECTION 1

EO M122.01 – IDENTIFY TYPES OF MAPS

Total Time: 30 min

PREPARATION

PRE-LESSON INSTRUCTIONS

Resources needed for the delivery of this lesson are listed in the lesson specification located in A-CR-CCP-701/PG-001, *Green Star Qualification Standard and Plan*, Chapter 4. Specific uses for said resources are identified throughout the instructional guide within the TP for which they are required.

Review the lesson content and become familiar with the material prior to delivering the lesson.

PRE-LESSON ASSIGNMENT

Nil.

APPROACH

An interactive lecture was chosen for TPs 1, 2 and 3 to introduce the cadets to the purpose, the various types, and the maintenance of maps.

A demonstration and performance was chosen for TP 4 as it allows the instructor to explain and demonstrate the folding of a map while providing cadets the opportunity to practise under supervision.

INTRODUCTION

REVIEW

Nil.

OBJECTIVES

By the end of this period the cadet shall be expected to identify different types of maps, care for maps, and properly fold a topographical map sheet.

IMPORTANCE

It is important to know the different map types and their uses in order to select the correct map for the task. Also, knowing how to fold and maintain these maps properly will keep them serviceable and in good condition.

Teaching Point 1**Explain the purpose of a map.**

Time: 5 min

Method: Interactive Lecture

PURPOSE OF A MAP

The purpose of a map is to pass on specific information. A map is a scale, or proportionately smaller, representation of the ground that uses internationally accepted symbols to represent both physical and man-made features found on the ground. They identify locations such as towns, lakes, and rivers by name. Map designs reflect the individual needs of the users (e.g. urban planners, travelers, education and cadets).



The art and science of making maps is called cartography. The oldest known maps are preserved on Babylonian clay tablets from about 2300 B.C.

CONFIRMATION OF TEACHING POINT 1**QUESTIONS**

Q1. The purpose of a map is to present a picture of what?

ANTICIPATED ANSWERS

A1. The ground as it exists.

Teaching Point 2**Describe the various types of maps.**

Time: 5 min

Method: Interactive Lecture



During this lesson, the first four map types (denoted with an asterisk) are a must know, as they are the ones cadets will use most often. The remainder are additional maps to which a cadet may be exposed.

*** TOPOGRAPHICAL MAP**

This type of map is commonly used by the military. The purpose of a topographical map is to present a picture of the ground as it really exists. Topographical maps show as much detail as the scale allows, generally 1:25 000, 1:50 000, or 1:250 000.

- **Physical features** of the ground, such as **natural features** (i.e. rivers, woods, and hills with the heights and shapes) as well **man-made features** (i.e. roads, railways, towns, villages and buildings etc.) are shown.
- **The names of specific features** such as towns, villages, rivers, and descriptive names of general features such as railways, fords and post offices are also found on topographical maps.

*** ORIENTEERING MAP**

Through the International Orienteering Federation (IOF), specific rules and standards have been set for the production of orienteering maps, including colour, symbols, and scales. They are much more detailed than regular topographic maps, both with reference to vegetation and landforms.

* **STREET AND ROAD MAP**

Street and road maps are designed to assist commuters and tourists to locate key site such as roads and highways, police stations, fire halls, hospitals, schools, parks and more.

* **RELIEF MAP**

Relief maps are a three dimensional representation, usually of terrain. The terrain elevation is usually exaggerated by a factor between five and ten. This helps to visually recognise the terrain features.

DIGITAL MAP

Digital maps, such as those found on computer programs and when using a GPS, are useful as reference tools as they are updated regularly. This allows for a generally more accurate reference.

POLITICAL MAP

Political maps show countries, provinces or other political borders (e.g. globes and atlases).

STATISTICAL MAP

Statistical maps show statistical information such as the production levels of crops or minerals across a country.

OUTLINE MAP

Outline maps show only borders, rivers, coastlines, etc.

AIR PHOTO MAP

Air photomaps are actual pictures used in reconnaissance or to create many of the maps listed.



Where local resources are available, the instructor may show actual copies of the above listed types of maps to cadets.

CONFIRMATION OF TEACHING POINT 2

QUESTIONS

- Q1. What type of map is most commonly used by the military?
- Q2. Orienteering maps are similar to, though more detailed with references to vegetation and landforms than, what other type of map?
- Q3. What is a street and road map used for?

ANTICIPATED ANSWERS

- A1. Topographical maps.
- A2. Topographical maps.
- A3. Assist commuters and tourists to locate key sites.

Teaching Point 3**Describe the care of a topographical map.**

Time: 5 min

Method: Interactive Lecture

CARE OF THE MAP

Some maps being produced are already waterproof; however, most maps are printed on normal paper. Paper maps are expensive and easily damaged. You must take precautions to protect them from water, dirt and wind. Maps, when exposed to water, will become soggy, deteriorate and tear.

Waterproofing a Map. Preparing a map for the elements is a vital step to prolong the life of the map. Ways to prepare a map for waterproofing include:

- **Zipper Bag Method.** This method requires a large heavy weight zipper bag and waterproof tape (duct or packing tape). Cut enough tape to completely adhere to one edge of the bag from corner to corner. Stick one half of the tape from corner to corner. Flip the bag over and fold the tape down on itself and the other side of the bag. Perform each step twice more to the other sides of the bag.
- **Contact Paper (Map Tac).** Covering the map with contact paper will waterproof the map; however, it will become very stiff. A permanent marker or grease pencil will be required to write on the map. Use rubbing alcohol to remove permanent marker from the contact paper.
- **Chemical Coatings.** Chemical coatings will be effective in waterproofing maps; however, they must be handled carefully in a well-ventilated area. They are applied with a brush, to a map on a flat surface, and must be allowed to fully dry before attempting to use them.

Drying a Map. If a map gets wet, let it dry completely on a flat clean surface.

Opening a Map. A map should never be fully opened in a strong wind. It should be opened to the area you are using, and refolded along the original fold lines.

Writing on a Map. Use only pencil to mark your maps and erase all markings gently. Maps that are protected by plastic can be marked using grease pencils or fine tipped markers.

Storing a Map. Maps should be stored in a dry place, rolled, folded, or laid flat.



Instructors should demonstrate examples of waterproofed maps, as resources permit.

CONFIRMATION OF TEACHING POINT 3

QUESTIONS

Q1. What are three things we should protect maps from?

Q2. What can we use to write on maps?

Q3. How are maps to be stored?

ANTICIPATED ANSWERS

A1. Water, dirt and wind.

A2. Pencil, if protected with plastic, then grease, pencil or erasable marker.

A3. Maps should be stored in a dry place, rolled, folded, or laid flat.

Teaching Point 4**Explain and demonstrate how to fold a map.**

Time: 10 min

Method: Demonstration and Performance

FOLDING A MAP

To properly fold a map, the following steps are to be followed:

1. Lay the map face up, then fold map in half by bringing the top (north) of the map sheet down to the bottom (south) of the map sheet. Crease where the bend in the map has occurred; this is the centre of the map (see Figure 1, Step 1).
2. Fold the top half of the map sheet into half again, then turn the map over and fold the bottom half to match the top half (see Figure 1, Step 2).
3. Fold the ends of the map into half from left to right (see Figure 1, Step 3).
4. Fold each of the open ends back into half again so that the map name and index to adjacent map sheet appears on the outside (the map should look like the letter M). (see Figure 1, Step 4).

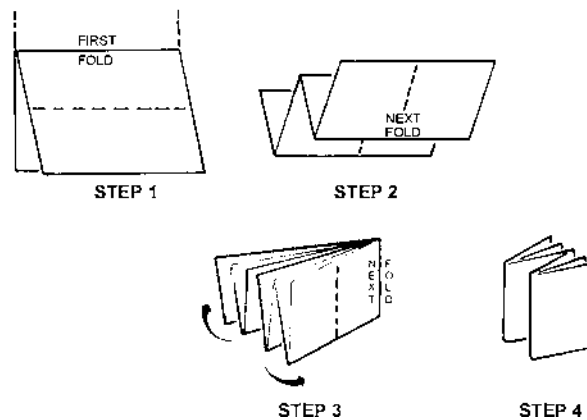

A-CR-CCP-121/PT-001, Royal Canadian Army Cadets Reference Book

Figure 1 Folding of a Map

CONFIRMATION OF TEACHING POINT 4

Have each cadet practice folding the topographical map sheet (located in the Green Star Handbook) in the method described above. An easy way to remember how to fold a map is north to south, south to north, east to west and west to east.

END OF LESSON CONFIRMATION

QUESTIONS

- Q1. What are some of the common maps discussed during this lesson?
- Q2. How do we dry a map when it gets wet?
- Q3. Using a piece of paper, fold it as you would a map.

ANTICIPATED ANSWERS

- A1. Topographical, orienteering, street and road, relief, political, statistical, outline and air photo.
- A2. Lay flat on a dry clean surface, and let dry completely.
- A3. Demonstrate.

CONCLUSION

HOMEWORK/READING/PRACTICE

The instructor shall have cadets practice folding a piece of paper as they would a map.

METHOD OF EVALUATION

Nil.

CLOSING STATEMENT

It is important to know the different map types and their uses, so that cadets can select the correct map for their needs. Also, knowing how to fold and maintain maps properly will keep them in good condition for a long time.

INSTRUCTOR NOTES/REMARKS

Types of maps will be limited to what is available at the corps level. Instructors should attempt to obtain as many examples as are available. Where local resources allow, products such as clear contact paper and chemical coating may be demonstrated.

Actual maps are not required to practise folding a map. A topographical map worksheet, 8-1/2-inch by 11-inch sheet of paper, newspaper, or retail flyer may be used to represent a map.

REFERENCES

A2-004 B-GL-382-005/FP-001 Canadian Forces. (1976). *Maps, Fields, Sketching, and Compasses* (Vol. 8). Ottawa, ON: National Defence.



ROYAL CANADIAN ARMY CADETS
GREEN STAR
INSTRUCTIONAL GUIDE



SECTION 2

EO M122.02 – IDENTIFY MARGINAL INFORMATION AND CONVENTIONAL SIGNS

Total Time:

60 min

PREPARATION

PRE-LESSON INSTRUCTIONS

Resources needed for the delivery of this lesson are listed in the lesson specification located in A-CR-CCP-701/PG-001, *Green Star Qualification Standard and Plan*, Chapter 4. Specific uses for said resources are identified throughout the instructional guide within the TP for which they are required.

Review the lesson content and become familiar with the material prior to delivering the lesson.

PRE-LESSON ASSIGNMENT

Nil.

APPROACH

An interactive lecture was chosen for TP 1 to orient the cadets to marginal information and generate interest.

An in-class activity was chosen for TP 2 as an interactive way to provoke thought and stimulate interest in conventional signs.

INTRODUCTION

REVIEW

The pertinent review for this lesson, from EO M122.01 (Section 1), Identify Types of Maps, will include:

- Q1. What type of map is most commonly used by the military?
- Q2. What are three things we should protect maps from?
- Q3. How are maps to be stored?

ANTICIPATED ANSWERS

- A1. Topographical.
- A2. Water, dirt, and wind.
- A3. Maps should be stored in a dry place, and rolled, folded, or laid flat.

OBJECTIVES

By the end of this lesson the cadet shall be expected to identify map features to include: marginal information, and conventional signs found on a topographical map.

IMPORTANCE

Cadets shall be able to identify features on the map as they relate to objects on the ground. The cadets will apply this knowledge during training where any type of map is to be used.

Teaching Point 1**Identify marginal information found on a topographical map.**

Time: 20 min

Method: Interactive Lecture

MARGINAL INFORMATION

The margins provide information important to the full understanding and use of the map. Before using any unfamiliar map, it is important to have a good look at the information contained in its margins. The layout and contents of the marginal information should be in relatively the same area for all topographical maps. This information includes:

- name of map sheet,
- number of the map and index of adjoining maps,
- date of map data,
- map scale,
- scale bars or graphic linear scales,
- contour interval,
- military index number, normally found at the top right corner of the map sheet, which is used for ordering additional maps,
- declination diagram,
- Universal Transverse Mercator Grid System (UTM), and
- legend of conventional signs.

Name of Map Sheet. For ease of reference the name of the map is usually a major community or district the map covers (you will find this at the bottom centre of the margin, as well as in the bottom right corner).



B-GL-382-005/FP-001, Military Training, Volume 8, Maps, Field Sketching and Compasses

Figure 1 Name of Map Sheet

Number of the Map and Index of Adjoining Maps. A diagram showing the position of the map sheet in relation to adjoining sheets is shown near the lower right hand margin. The diagram shows the sheet numbers of the adjoining sheets and accentuates the sheet in hand.

94 A/2	94 A/1	84 D/4
93 P/15	93 P/16	83 M/13
93 P/10	93 P/9	83 M/12

B-GL-382-005/FP-001, Military Training, Volume 8, Maps, Field Sketching and Compasses

Figure 2 Index of Adjoining Maps

Date of Map Data. Helps to indicate the amount of change that may have occurred since the map was printed (you will find it in the copyright information in the bottom left and right corners).

**PRODUCED BY THE CANADA CENTRE FOR MAPPING,
DEPARTMENT OF ENERGY, MINES AND RESOURCES.
FROM ARIAL PHOTOGRAPHS TAKEN IN 1981.
CULTURE CHECK 1984. PUBLISHED IN 1989.**

B-GL-382-005/FP-001, Military Training, Volume 8, Maps, Field Sketching and Compasses

Figure 3 Date of Map Data

Map Scale. The scale of the map, e.g. 1:50 000, is shown prominently in the bottom margin.

Scale 1:50 000

B-GL-382-005/FP-001, Military Training, Volume 8, Maps, Field Sketching and Compasses

Figure 4 Map Scale

Scale Bars. Used to help measure distance on the map (you will find them under the map scale, bottom centre). Notice how the left end of the scale bars is divided into tenths for measuring accurate distances.

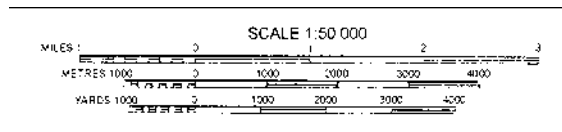

B-GL-382-005/FP-001, Military Training, Volume 8, Maps, Field Sketching and Compasses

Figure 5 Scale Bars

Contour Interval. Used to indicate a set distance between the contour lines. The contour interval could be in feet or metres (you will find this in the bottom margin, just right of the scale bars).

CONTOUR INTERVAL 10 METRES
ELEVATIONS IN METRES ABOVE MEAN SEA LEVEL
NORTH AMERICAN DATUM 1927
TRANSVERSE MERCATOR PROJECTION

B-GL-382-005/FP-001, Military Training, Volume 8, Maps, Field Sketching and Compasses

Figure 6 Contour Interval

Military Index Number for Ordering This Map. The index is found in the top right corner of the map sheet; used for ordering additional maps, and includes the following information:

- Map series number, which identifies both the area and the scale of the map and the series number taken from the map catalogue.
- Sheet numbers or name to identify the map (identity by sheet name is rare).
- Edition designation (identifies the currency of the information shown on the map; the edition number will increase with each revision).

Military users, refer to this map as:	SERIES A 751 MAP 31 D/2 EDITION 5 MCE
--	---

B-GL-382-005/FP-001, Military Training, Volume 8, Maps, Field Sketching and Compasses

Figure 7 Military Index Number

Declination Diagram. Each map contains the information necessary to relate the true, grid, and magnetic bearing of any line within the area covered by the map sheet. This information is given in the form of a diagram with explanatory notes. The diagram is in the right side margin.



B-GL-382-005/FP-001, Military Training, Volume 8, Maps, Field Sketching and Compasses

Figure 8 Declination Diagram

Universal Transverse Mercator (UTM) Grid System. The UTM grid is divided into “zones”, each covering six degrees of longitude and eight degrees of latitude. The 60 longitude bands are numbered and the 20 latitude

bands are lettered. Each grid zone is one rectangle of the grid pattern, established by the bands and designated by the figures of the longitude band followed by the letter of latitude band (e.g. 17T).

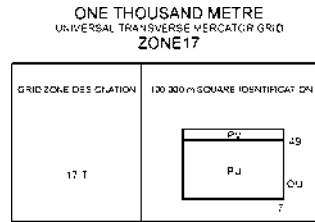

B-GL-382-005/FP-001, Military Training, Volume 8, Maps, Field Sketching and Compasses

Figure 9 UTM Grid System

Conventional Signs. A table showing the conventional signs used on the sheet in their correct colours with their descriptions is shown in the bottom or side margin, plus in a more complete list on the back of the map.

CONFIRMATION OF TEACHING POINT 1

QUESTIONS

- Q1. Where are the map name, scale, and scale bar found?
- Q2. Where is the date of map data found?
- Q3. Where is the declination diagram found?

ANTICIPATED ANSWERS

- A1. At the bottom centre of the map sheet.
- A2. Bottom right and bottom left corner of the map sheet.
- A3. Right side of the map sheet.

Teaching Point 2

Identify conventional signs.

Time: 30 min

Method: In-Class Activity

BACKGROUND INFORMATION

Conventional Signs

The information in this teaching point is presented to provide the instructor with background knowledge of conventional signs. The instructor may choose to review the information with the cadets prior to the commencement of the activity outlined below.

A number of symbols are used to indicate an object or item of detail that cannot be shown either by outline or by a line symbol. Most have been established through long usage and standardization agreements. The meaning of most symbols is obvious. If there is doubt however, consult the table of conventional symbols located on every map. Located on the back of most maps you will find many additional conventional signs.

Map reading not only involves the ability to interpret the symbols shown on the map and to understand the information given in pictorial or written form, but it also involves a true understanding of the ground portrayed and an appreciation of the reliability and value of the particular map being used.

Where the symbol may have more than one meaning, the sign or symbol will be accompanied by a descriptive word (e.g. tank or tower).

The use of different colours is a major means of showing and distinguishing detail of any or all types of detail.

Man-made Features by Colour









Red is used to identify paved roads and highway numbers. Red is also used to shade in areas of urban development.

Road paved surface 2 lane; 1 lane (red)	
--	--

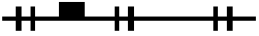
Orange is used to represent unpaved roads.



Road loose surface 2 lane; 1 lane (orange)	
---	--

Black is used for cultural features, toponyms (place names), some symbols and precise elevations.

Tunnel	
Railway (single track)	
Railway (multiple track) with station	
Road/Track	
School	
Fire Department	
Police Station	
Church	
Buildings	

Natural Features by Colour

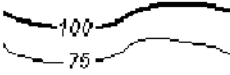
Brown is used for contour lines, contour elevations, spot elevations, sand, cliffs, and other geological features.

Contours (dark)	
Cliff (dark)	
Sand (brown)	

Blue is used for water or permanent ice features (i.e., rivers, lakes, swamps and ice fields), names of water features and the grid lines.

River with arrow indicating direction of flow	
Rapids	

Green, which is used for vegetation features (i.e., woods, orchards and vineyards).

Orchard (green)	
-----------------	--

Additional Features by Colour

Grey is used for the legend of conventional signs on the back of the map.

Purple is used for updates that are made over top of the original map information.

ACTIVITY – BUILDING MAPVILLE

Time: 31 min

OBJECTIVE

- By the end of this lesson, the cadet shall be expected to identify and draw conventional signs.

RESOURCES

- Flipchart/whiteboard.
- Markers/dry erase markers.

ACTIVITY LAYOUT

This activity will be a participative exercise designed to involve the cadets, while teaching the various conventional signs found on a topographical map. The cadets will design and draw the map for a new town called Mapville.

Activity Instructions:

- The instructor will draw a large outline of a topographical map on the flipchart/whiteboard at the front of the room.
- The cadets will be asked to approach the front, one at a time, and draw a conventional sign on the developing map of Mapville.
- The cadets must explain what the sign is for and why they chose to put it where they did.
- No sign may be used more than once.
- The instructor may choose to take a photograph of the finished product, to display around the parade area.

SAFETY

- This is a supervised activity.

INSTRUCTOR GUIDELINES

- Instructors are to continuously supervise and monitor the activity to ensure the material being presented is being utilized correctly.
- In the event of misplaced or misused conventional signs, the instructor shall stop the cadets, correct the problem, and have the cadets return to their seats. Have the cadets attempt another sign at the end of the activity.
- The instructor is to observe carefully, as this activity will constitute the final confirmation of the lesson.

CONFIRMATION OF TEACHING POINT 2

The activity outlined above will serve as the confirmation of this teaching point.

END OF LESSON CONFIRMATION

The activity at the end of TP2 will serve as the confirmation of this lesson.

CONCLUSION

HOMEWORK/READING/PRACTICE

Nil.

METHOD OF EVALUATION

The cadet will be required to properly identify marginal information and conventional signs found on a topographical map.

CLOSING STATEMENT

The information presented in this lesson will enable the cadet to identify features on the map as they relate to objects on the ground. The cadets will apply this knowledge during any training where any type of map is to be used.

INSTRUCTOR NOTES/REMARKS

Nil.

REFERENCES

A2-004 B-GL-382-005-FP-001 Canadian Forces. (1976). *Maps, Fields, Sketching, and Compasses* (Vol. 8). Ottawa, ON: National Defence.



ROYAL CANADIAN ARMY CADETS
GREEN STAR
INSTRUCTIONAL GUIDE



SECTION 3

EO M122.03 – INTERPRET CONTOUR LINES

Total Time: 30 min

PREPARATION

PRE-LESSON INSTRUCTIONS

Resources needed for the delivery of this lesson are listed in the lesson specification located in A-CR-CCP-701/PG-001, *Green Star Qualification Standard and Plan*, Chapter 4. Specific uses for said resources are identified throughout the instructional guide within the TP for which they are required.

Review the lesson content and become familiar with the material prior to delivering the lesson.

PRE-LESSON ASSIGNMENT

Nil.

APPROACH

An interactive lecture was chosen for this lesson to orient the cadets to the interpreting of contour lines.

INTRODUCTION

REVIEW

The pertinent review for this lesson will include a review of EO M122.02 (Section 2).

- Q1. What kind of information is found in the margin of a map?
- Q2. What is a conventional sign?
- Q3. Which natural features are shown in brown on a map?

ANTICIPATED ANSWERS

- A1. Any from the list below:
- name of map sheet;
 - number of the map and index of adjoining maps;
 - date of map data;
 - map scale;
 - scale bars or graphic linear scales;
 - contour interval;

- military index number;
- declination diagram;
- Universal Transverse Mercator Grid System (UTM); and
- legend of conventional signs.

A2. A symbol used to indicate an object or item of detail that cannot be shown either by outline or by a line symbol.

A3. Brown is used for contour lines, contour elevations, spot elevations, sand, cliffs, and other geological features.

OBJECTIVES

By the end of this lesson the cadet shall be expected to interpret contour lines in order to identify the shape of the ground as depicted on a map.

IMPORTANCE

This information allows the cadet to be able to identify features on the map as they relate to the shape and elevation of the ground. Cadets will apply this knowledge during training where any type of map is to be used. Knowing the shape of the ground will allow cadets to identify major landforms that may be nearby, thereby helping to identify their position on the map.

Teaching Point 1**Explain and demonstrate how contour lines indicate the shape of the ground.**

Time: 25 min

Method: Demonstration and Performance



The teaching of relief on a blackboard or plane surface should be avoided if at all possible. The construction of simple three-dimensional models such as those made out of putty or soft earth can help, but there is no substitute for outdoor instruction.

DEFINITION OF RELIEF ON A MAP

“Relief,” or elevation, is the shape of the ground in a vertical plane. Relief on a map is the showing of the heights and shapes of the ground, above mean sea level, in feet or metres.

There are two distinct elements in the representation of relief. These are:

- **Representation of Height.** This is a fact-based representation of the height of the land and of landforms. Differences in appearance on the map will arise from the type, density and accuracy of the information provided.
- **Representation of Shape.** This may be largely artistic, and the methods used will vary between maps.

CONTOUR LINES AND INTERVALS

A contour is a line on the map joining points of equal elevation in relationship to sea level, and is the standard method of showing relief on topographical maps.

Contours are shown at a regular vertical interval (difference in height between contours lines) that is called the contour interval. The contour interval is always stated in the margin of the map, normally near the graphic scales.

Contours are normally drawn as continuous brown lines. Every fourth or fifth contour is called an “Index Contour” and is shown by a thicker brown line; this helps in reading and counting the contours to determine a height.

INTERPRETING CONTOUR LINES

Interpreting contour lines provides a visualization of the shape of the ground, which is shown on the map by contour lines and contour intervals. Correct interpretation of the shape of the ground from contour lines requires practice and practical experience on the ground. It is essential to study various features, comparing the map to the ground in each case.

SLOPES

The instructor shall explain the following landforms by identifying the depiction on the map, followed by showing the landform in the field. In the event that models are being used in place of real ground, the model shall be introduced as the respective landform is presented. Where putty is used, fishing line can be used to slice through the landform model illustrating the concept of a contour line.

The distance between contour lines on the map will indicate to you the type of slope on the ground.

- **Steep Slope.** When the contour lines are spaced closely together there is less distance to travel to gain or lose elevation (see Figure 1).
- **Gentle Slope.** When the contour lines are further apart there is a greater distance to travel to gain or lose elevation (see Figure 1).
- **Uniform Slope.** When the contours are an equal distance apart. The slope remains constant in its decline, whether steep or gentle (see Figure 1).
- **Spurs.** A contour feature that extends out from a slope (see Figure 2).
- **Re-entrants.** A contour feature that cuts back into a slope (see Figure 2).
- **Concave Slope.** When the spacing of the contours gets further apart at the bottom. The middle of the slope seems to depress inward – appearing concave (see Figure 3).
- **Convex Slope.** When the spacing of contours down a slope gets close together at the bottom. The middle of the slope seems to bulge outward – appearing convex (see Figure 4).

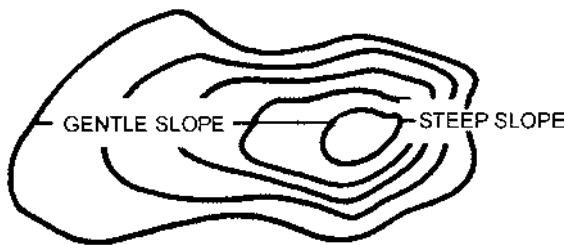

Basic Map Using A-CR-CCP-108/PT-001

Figure 1 Gentle/Steep Slopes

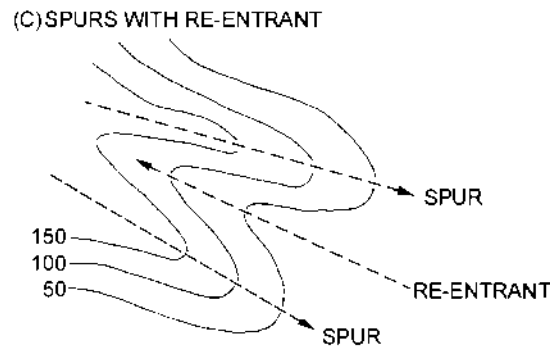

Map Field Sketch and Compass B-GL-382-005-FP-001

Figure 2 Spur and Re-entrant

(E) CONCAVE SLOPE
(STEEPER AT TOP THAN LOWER DOWN)

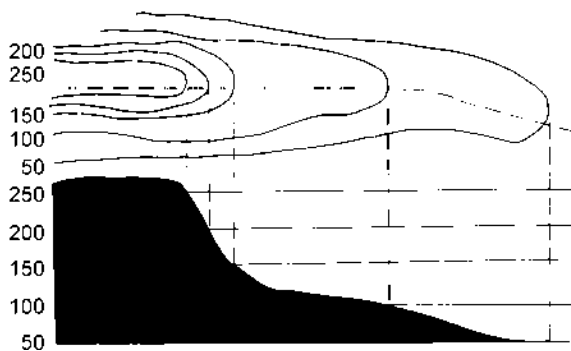

Map Field Sketch and Compass B-GL-382-005-FP-001

Figure 3 Concave Slope

(F) CONVEX SLOPE
(STEEPER AT LOWER END)

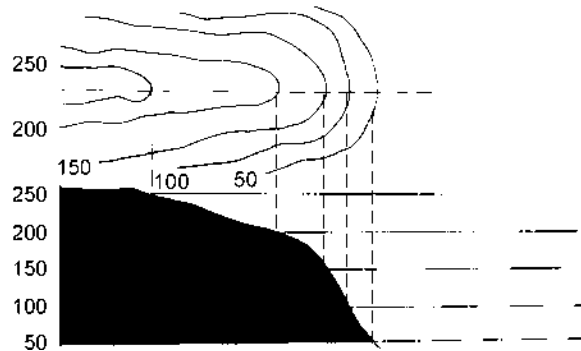

Map Field Sketch and Compass B-GL-382-005-FP-001

Figure 4 Convex Slope

CONFIRMATION OF TEACHING POINT 1

QUESTIONS

- Q1. The relief on a map shows what two elements?
- Q2. What is the name given to the difference in height between contours lines?
- Q3. What are some of the different types of slopes identified on a map?

ANTICIPATED ANSWERS

- A1. The height and shape of the ground.
- A2. The contour interval.
- A3. Steep, gentle, uniform, concave and convex.

END OF LESSON CONFIRMATION

The information learned in this is EO can be practiced with the activity found at Attachment A. Allow cadets to complete the activity found at Attachment A, then have them switch sheets for correcting.

Alternately, the instructor may choose to have the cadets identify the respective features on a map of an area being used for an upcoming exercise.



A correctly labelled diagram is located at Page M122.03A-2 of Attachment A.

CONCLUSION

HOMEWORK/READING/PRACTICE

Nil.

METHOD OF EVALUATION

During the confirmation activity for EO M122.CA, Follow a Route Led by a Section Commander (A-CR-CCP-701/PG-001, Chapter 4, Section 11), the cadets shall be expected to identify their positions by relating major landmarks in the immediate vicinity to what is portrayed on the map. Relief types and landforms are excellent points of reference for this task.

CLOSING STATEMENT

Knowing how to interpret contour lines allows cadets to visualize the shape of the ground by reading a map.

INSTRUCTOR NOTES/REMARKS

This lesson shall be taught in an outdoor setting. The instructor should use actual elevation and relate it to the contour lines on the map. Although the use of simple models may help, it is not a substitute to outdoor instruction.

REFERENCES

A2-004 B-GL-382-005-FP-001 Canadian Forces. (1976). *Maps, Fields, Sketching, and Compasses* (Vol. 8). Ottawa, ON: National Defence.

INTERPRETING CONTOUR LINES

Match the contour diagram on the left to the applicable depiction of a landform on the right.



1

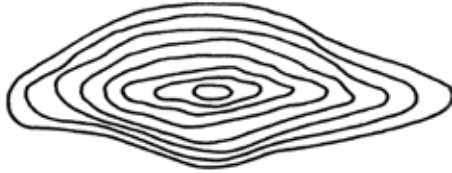

2

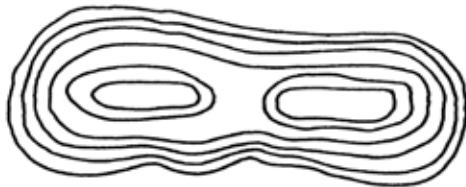

3

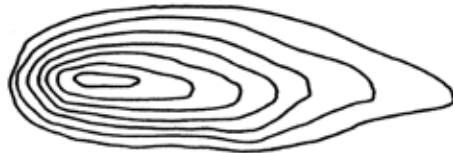

4



5

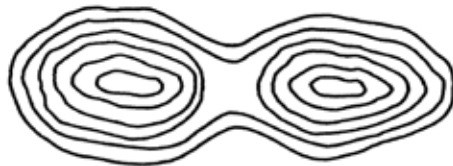

6



A



B



C



D



E



F

1. _____

2. _____

3. _____

4. _____

5. _____

6. _____

INTERPRETING CONTOUR LINES

ANSWER KEY



1

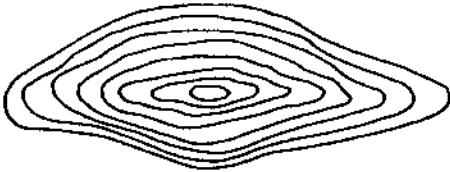

2

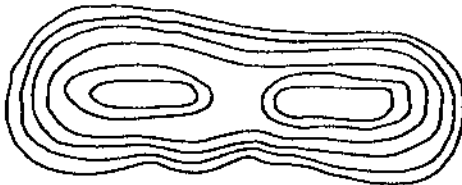

3



4



5



6



A



B



C



D



E



F

1. B

2. E

3. D

4. C

5. F

6. A



ROYAL CANADIAN ARMY CADETS
GREEN STAR
INSTRUCTIONAL GUIDE



SECTION 4

EO M122.04 – ORIENT A MAP BY INSPECTION

Total Time:

30 min

PREPARATION

PRE-LESSON INSTRUCTIONS

Resources needed for the delivery of this lesson are listed in the lesson specification located in A-CR-CCP-701/PG-001, *Green Star Qualification Standard and Plan*, Chapter 4. Specific uses for said resources are identified throughout the instructional guide within the TP for which they are required.

Review the lesson content and become familiar with the material prior to delivering the lesson.

PRE-LESSON ASSIGNMENT

Nil.

APPROACH

An interactive lecture was chosen for TP 1 to orient the cadets to the purpose of orienting a map by inspection.

A demonstration and performance was chosen for TP 2 as it allows the instructor to explain and demonstrate the procedure for orienting a map by inspection while providing an opportunity for the cadets to practice this skill.

INTRODUCTION

REVIEW

The pertinent review for this lesson from EO M122.03 (Section 3) will include:

QUESTIONS

- Q1. The relief on a map represents what two elements above mean sea level?
 Q2. What is the difference in height between contour lines called?

ANTICIPATED ANSWERS

- A1. The height and shape of the ground.
 A2. The contour interval.

OBJECTIVES

By the end of this lesson the cadet shall be expected to properly orient a map by inspection.

IMPORTANCE

Orienting a map by inspection makes it easy to relate information on the map to features on the ground. It is important to have the map oriented when moving over a complex route in order to reach your destination.

Teaching Point 1**Explain the purpose of orienting a map by inspection.**

Time: 5 min

Method: Interactive Lecture

ORIENT A MAP BY INSPECTION

Orienting a map by inspection means to turn the map so that, visually, the map directions and map detail correspond with that which is on the ground. This is the simplest and quickest way of orienting a map, provided you have a general idea of your own position.

Orienting the map does a number of things:

- it makes it easy to relate the map to the ground when direction and distance on the map corresponds to the ground;
- it helps you find your location or direction if you are in doubt; and
- when moving over a complex route, or when traveling over long distances, orienting the map will keep you on the right track.

CONFIRMATION OF TEACHING POINT 1

QUESTIONS

Q1. What does “orienting a map” by inspection mean?

Q2. What three things does orienting a map do?

ANTICIPATED ANSWERS

A1. To turn the map so that visually the map directions and map detail corresponds with that which is on the ground.

A2. Three things are:

- it makes it easy to relate the map to the ground when direction and distance on the map corresponds to the ground;
- it helps you find your location or direction if you are in doubt; and
- when moving over a complex route, or when traveling over long distances, orienting the map will keep you on the right track.

Teaching Point 2**Explain and demonstrate how to orient a map.**

Time: 20 min

Method: Demonstration and Performance

ORIENT A MAP

In order to orient your map by inspection the following steps should be followed:

1. identify your approximate location on the map;
2. identify two or three prominent objects or landmarks on the ground and find them on the map. Try to use landmarks in different directions;

3. rotate your map until all identified objects on the map line-up with the direction in which objects are located on the ground; and
4. check visually to ensure that all features to your front are in front of your position on the map.

CONFIRMATION OF TEACHING POINT 2



The cadets shall practice orienting their maps by inspection. In the event of inclement weather, a mock field environment can be simulated to practice this skill (e.g. placing pictures depicting prominent objects on the walls corresponding to their location on the map).

END OF LESSON CONFIRMATION

QUESTIONS

Q1. What are the four steps to orienting a map by inspection?

ANTICIPATED ANSWERS

A1. In order to orient your map by inspection, you would:

- (1) identify your approximate location on the map;
- (2) identify two or three prominent objects or landmarks on the ground and find them on the map. Try to use landmarks in different directions;
- (3) rotate your map until all identified objects on the map line up with the direction in which objects are located on the ground; and
- (4) check visually to ensure that all features to your front are in front of your position on the map.

CONCLUSION

HOMEWORK/READING/PRACTICE

Nil.

METHOD OF EVALUATION

The cadet will be required to orient a map by inspection using a topographical map during a field navigation exercise.

CLOSING STATEMENT

Knowing how to visually set your map so that features on the map match those on the ground is important as it enables you to determine the location of an object, or oneself.

INSTRUCTOR NOTES/REMARKS

Nil.

REFERENCES

A2-004 B-GL-382-005-FP-001 Canadian Forces. (1976). *Maps, Fields, Sketching, and Compasses* (Vol. 8). Ottawa, ON: National Defence.

THIS PAGE INTENTIONALLY LEFT BLANK



ROYAL CANADIAN ARMY CADETS
GREEN STAR
INSTRUCTIONAL GUIDE



SECTION 5

EO M122.05 – DETERMINE A GRID REFERENCE

Total Time: 60 min

PREPARATION

PRE-LESSON INSTRUCTIONS

Resources needed for the delivery of this lesson are listed in the lesson specification located in A-CR-CCP-701/PG-001, *Green Star Qualification Standard and Plan*, Chapter 4. Specific uses for said resources are identified throughout the instructional guide within the TP for which they are required.

Review the lesson content and become familiar with the material prior to delivering the lesson.

PRE-LESSON ASSIGNMENT

Nil.

APPROACH

An interactive lecture was chosen for TP 1 to orient the cadets to grid lines and to the difference between eastings and northings.

A demonstration and performance was chosen for TPs 2 to 5 as it allows the instructor to explain and demonstrate how to determine 4 and 6 figure GR while providing an opportunity for the cadets to practice those skills.

INTRODUCTION

REVIEW

The pertinent review for this lesson from EO M122.04 (Section 4) will include:

- Q1. What are the vertical (X-axis) blue lines on a map called?
- Q2. What are the horizontal (Y-axis) blue lines on a map called?
- Q3. When the writing on a map is the right way up, where is north normally located?

ANTICIPATED ANSWERS

- A1. Eastings.
- A2. Northings.
- A3. At the top of the map.

OBJECTIVES

By the end of this lesson the cadet shall be expected to determine four and six figure Grid Reference (GR) (within +/- 1000 and 100 metres accuracy, respectively), for a series of features on a topographical map.

IMPORTANCE

As an army cadet it is important to know how to use the grid system. Since the grid system is the basis of map reading, the concept of a four-figure and six-figure GR will be a stepping stone to becoming a strong map-reader. A GR details the location of a grid square on a map, and prevents confusion about location. Communication about exact locations over the radio is made possible with an understanding of a GR.

Teaching Point 1**Explain the use of grid lines.**

Time: 5 min

Method: Interactive Lecture

USE OF GRID SYSTEM

The grid system is a rectangular network of intersecting vertical and horizontal blue lines superimposed on a topographical map. Maps are normally printed so that north is at the top of the sheet when the writing is the right way up. The lines of the grid system are drawn evenly spaced so that one set of lines run north to south (vertically) and the second set of lines run east to west (horizontally). These lines are assigned a sequential number starting in the bottom left corner. The intersecting grid lines at the lower left corner designate a grid square.

EASTINGS

Because the vertical lines are numbered from east to west, they are called **eastings**. Eastings are a series of parallel lines plotted as an overlay to the map sheet, with a two-digit number at the top and bottom end of each line in the margins.

NORTHINGS

Because the horizontal lines are numbered from the equator toward the north, they are called **northings**. Northings are a series of parallel lines plotted as an overlay to the map sheet, with a two-digit number at the left and right end of each line in the margins.

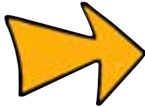

The most southerly point of Canada is Middle Island in Lake Erie, approximately 4 620 000 metres from the equator at latitude 41° 41' north.

CONFIRMATION OF TEACHING POINT 1

QUESTIONS

- Q1. When the writing on a map is the right way up, where is north normally located?
- Q2. What are the vertical blue lines on a map called?
- Q3. What are the horizontal blue lines on a map called?

ANTICIPATED ANSWERS

- A1. At the top of the map.
- A2. Eastings.
- A3. Northings.

Teaching Point 2**Explain and demonstrate a four-figure GR.**

Time: 10 min

Method: Demonstration and Performance

GRID REFERENCE

The military traditionally identify grid lines by stating the two-digit number of each grid line. When a location is identified using the grid system it is called a "Grid Reference" (GR). When giving a GR to a square, the reference is always to the southwest (bottom left) corner of the square. GRs are always given with the easting value first, followed by the northing value.

FOUR-FIGURE GR

A four-figure GR is used to identify a specific 1000 metres by 1000 metres grid square. It will have four numerical digits derived from the numbers assigned to the eastings on the X-axis, and the northings on the Y-axis, where the grid lines intersect at the bottom left corner of the grid square.

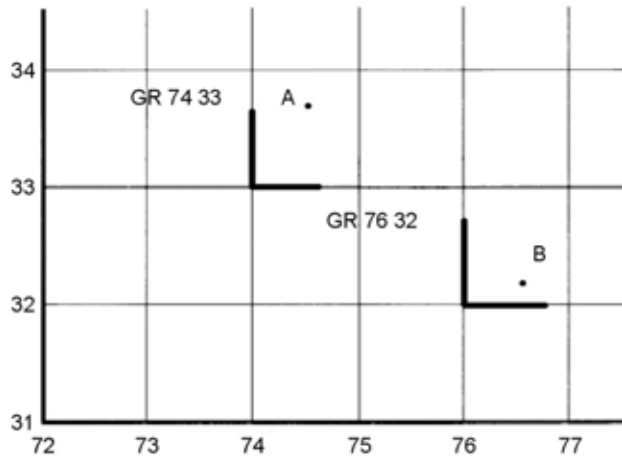

B-GL-382-005/PF-001, Military Training, Volume 8, Maps, Field Sketching and Compasses

Figure 1 Four-figure GR



The instructor will provide a minimum of three practice points for the cadets to use in determining a four-figure GR. It is important for the cadet to be equally able to identify a location on a map when given the GR and to determine the GR for a location indicated on a map.

CONFIRMATION OF TEACHING POINT 2**QUESTIONS**

- Q1. When giving a GR, the reference is always to which corner of the square?
- Q2. When giving a four-figure GR, in what order are the numbers given?
- Q3. A four-figure GR identifies a grid square of what size?

ANTICIPATED ANSWERS

- A1. Southwest or bottom left corner.
 A2. Eastings then northings, or X-axis then Y-axis.
 A3. 1000 metres by 1000 metres.

Teaching Point 3

Explain and demonstrate how to determine a six-figure GR.

Time: 10 min

Method: Demonstration and Performance

ACCURACY OF A GRID REFERENCE

The accuracy of a four-figure GR on a topographical map sheet is 1000 metres. When a more precise location is required, a six-figure GR is used which is accurate to 100 metres.

SIX-FIGURE GR

A six-figure GR is used to determine a more accurate location within a specific grid square. It is necessary to break up the grid square shown on the map into 100 subdivisions (10 in each direction). By creating an imaginary grid inside a grid square, we can use the same principles of the four-figure grid reference to make a more accurate statement of location. Each small easting and northing is numbered 1 to 9, from west to east and from south to north respectively. This imaginary grid inside a square can be estimated, or you can measure accurately using a tool called a "romer".

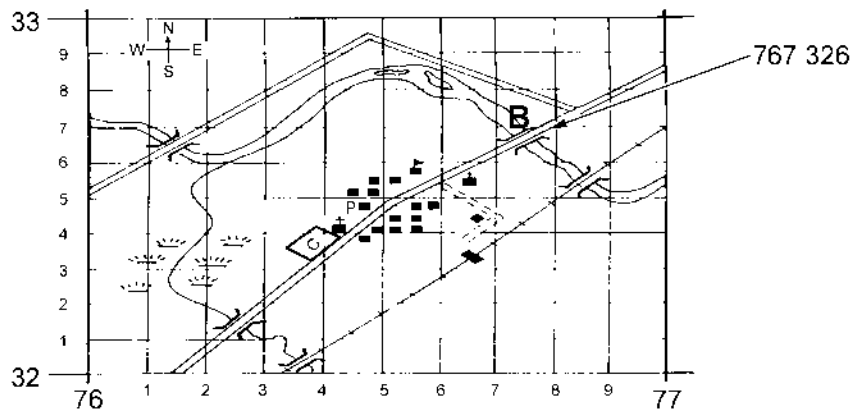

B-GL-382-005/PF-001, Military Training, Volume 8, Maps, Field Sketching and Compasses

Figure 2 Six-figure GR



Figure 2 shows the detail within the square 7632, which contains Point "B", a bridge. The centre point of this bridge is in the small square whose southwest corner is 7/10 east of easting 76, and also 6/10 north of northing 32. Its easting is thus 76.7 and its northing 32.6 units. Omitting the decimal points, the GR is thus written as 767 326.



Using Figure 2, the instructor will provide three points for the cadets to use to estimate a six-figure GR and give three six-figure GR cadets can use to locate a point on the map.

CONFIRMATION OF TEACHING POINT 3

QUESTIONS

- Q1. Is a six-figure GR more accurate than a four-figure GR?
- Q2. To get a six-figure GR, the grid square is divided into how many smaller squares?
- Q3. In what order are the numbers given?

ANTICIPATED ANSWERS

- A1. Yes.
- A2. 100.
- A3. Eastings then northings.

Teaching Point 4

Define a romer and its use.

Time: 10 min

Method: Demonstration and Performance

ROMER

A romer is used to accurately measure a six-figure GR. Using a romer provides a more accurate GR, and can be used in place of estimating.

TYPES OF ROMERS

Romers for 1:25 000 and 1:50 000 scales in metres are included on the base plate of the compass and are also found on the Protractor C2. If these romers are not available, one can be easily made from a clean piece of paper with a square edge.



A-CR-CCP-121/PT-001

Figure 3 Compass

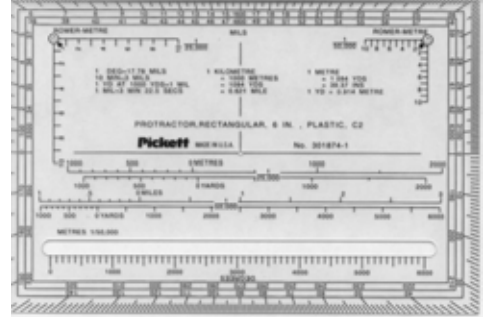

A-CR-CCP-121/PT-001

Figure 4 Protactor C2

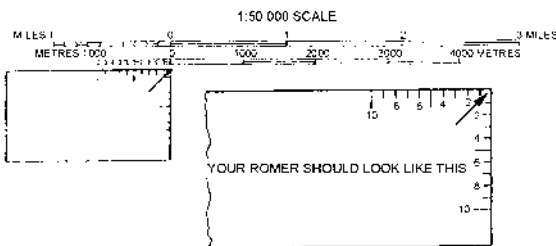

A-CR-CCP-121/PT-001

Figure 5 Constructing a Romer

CONSTRUCT A ROMER

A romer can be easily constructed for determining a six-figure GR:

- select a clean piece of paper with a square edge;
- starting at the corner of the GR, place the paper along the 100 m map scale;
- mark off 10 equal sub-divisions, starting at the corner and working outward;
- number the markings from zero (at the corner of the paper) to 10; and
- repeat the first four steps on the adjacent edge of the corner of paper.



The instructor shall provide cadets with blank pieces of paper and ensure sharp pencils are available. Stress the importance of always using a sharp pencil when using a map.

CONFIRMATION OF TEACHING POINT 4



Have cadets construct a romer by following the process outlined above.

Teaching Point 5**Explain and demonstrate how to determine a six-figure GR with a constructed romer.**

Time: 15 min

Method: Demonstration and Performance

DETERMINE A SIX-FIGURE GR

Figure 6 Determining a Six-figure GR with a Romer

A six-figure grid reference can be determined using a constructed romer by following these steps:

- place the corner of the constructed romer on the grid square;
- move the constructed romer **IN** the number of tenths required to align the romer directly below the conventional sign, or the location for which the GR is being determined;
- move the constructed romer **UP** the number of tenths required for the corner of the romer to be positioned on the conventional sign, or location for which the GR is being determined;
- read the value along the X-axis of the romer where it crosses the easting of the grid square (the value at this intersection becomes the third digit of the six-figure GR); and
- read the value along the Y-axis of the romer where it crosses the northing of the grid square (the value at this intersection become the sixth digit if the six-figure GR).

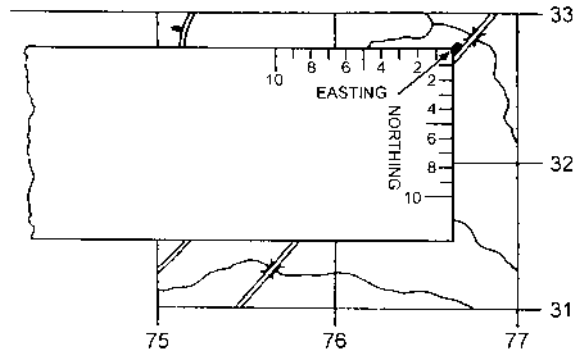

When completing Point d and e above, ensure cadets are aware that they will always round down to the closest third digit. Grid references should be written in the format GR XXX/XXX to help illustrate how the first half of the GR relates to the Easting and the second half relates to the Northing.

CONFIRMATION OF TEACHING POINT 5

The instructor shall provide the cadet a minimum of three practice points to use in determining a six-figure GR and three GR to use to locate a prominent object.

END OF LESSON CONFIRMATION

1. The instructor shall provide two points for the cadets to use in determining four-figure GRs.
 2. The instructor shall provide two points to use in determining six-figure GRs.
-

CONCLUSION

HOMEWORK/READING/PRACTICE

Nil.

METHOD OF EVALUATION

The cadet will be required to determine a four-figure GR and a six-figure GR using a constructed romer on a topographical map, as part of the confirmation activity for EO M122.CA, Follow a Route Led by a Section Commander (A-CR-CCP-701/PG-001, Chapter 4, Section 11).

CLOSING STATEMENT

Knowing how to determine a four-figure and a six-figure GR is essential for functioning safely in the field, for determining the accurate location of an object or oneself, and for communicating that position to others.

INSTRUCTOR NOTES/REMARKS

Cadets are to be provided with adequate time during field training exercises to practice this skill.

REFERENCES

A2-004 B-GL-382-005-FP-001 Canadian Forces. (1976). *Maps, Fields, Sketching, and Compasses* (Vol. 8). Ottawa, ON: National Defence.

THIS PAGE INTENTIONALLY LEFT BLANK



ROYAL CANADIAN ARMY CADETS
GREEN STAR
INSTRUCTIONAL GUIDE



SECTION 6

EO M122.06 – FOLLOW A ROUTE LED BY A SECTION COMMANDER

Total Time:

30 min

THERE IS NO INSTRUCTIONAL GUIDE PROVIDED FOR THIS EO

THIS PAGE INTENTIONALLY LEFT BLANK



ROYAL CANADIAN ARMY CADETS
GREEN STAR
INSTRUCTIONAL GUIDE



SECTION 7

EO C122.01 – PRACTICE NAVIGATION AS A MEMBER OF A TEAM

Total Time:

90 min

PREPARATION

PRE-LESSON INSTRUCTIONS

Resources needed for the delivery of this lesson are listed in the lesson specification located in A-CR-CCP-701/PG-001, *Green Star Qualification Standard and Plan*, Chapter 4. Specific uses for said resources are identified throughout the instructional guide within the TP for which they are required.

Review the lesson content and become familiar with the material prior to delivering the lesson.

PRE-LESSON ASSIGNMENT

Nil.

APPROACH

A practical activity was chosen for this lesson as it is an interactive way to allow the cadets to experience navigation in a safe and controlled environment. This activity contributes to the development of navigational skills in a fun and challenging setting.

INTRODUCTION

REVIEW

The pertinent review for this lesson will include:

- a. A review of EO M122.01 (Section 1), Identify Types of Maps.
 - Q1. What are some common types of maps used?
 - Q2. What can we use to write on maps?
- b. A review of EO M122.02 (Section 2), Identify Marginal Information and Conventional Signs.
 - Q1. What is the purpose of marginal information?
 - Q2. What is the purpose of conventional signs?

ANTICIPATED ANSWERS

- a. Review of EO M122.01 (Section 1)
 - A1. Topographical, orienteering, street and road, relief, political, outline, and air photo.
 - A2. Pencil (If protected with plastic, grease pencil or erasable marker).
- b. Review of EO M122.02 (Section 2)
 - A1. Marginal information gives information important to the understanding and use of the map.
 - A2. A symbol used to indicate an object or item of detail that cannot be shown either by outline or by a line symbol.

OBJECTIVES

By the end of this lesson the cadet shall be expected to be better prepared to participate in a short navigation exercise under the supervision of a senior cadet.

IMPORTANCE

The experience of practicing the skills learned in previous lessons will help to enhance the cadets' navigation skills. Map reading is a skill, which must be learned by practice on the ground. This practice is essential to building up experience, and developing a "feel" for maps, which will allow map reading to become instinctive.

BACKGROUND KNOWLEDGE

ACTIVITY 1 – NAVIGATION USING A STREET MAP

The EO's covering the information required to conduct this exercise are EO M122.01 (Section 1), Identify Types of Maps, EO M122.02 (Section 2), Identify Marginal Information and Conventional Signs, and EO M122.05 (Section 5), Determine a Grid Reference. Refer to the specified Instructional Guides for further information.

ACTIVITY 2 – NAVIGATION SCAVENGER HUNT

The EO's covering the information required to conduct this exercise are EO M122.01 (Section 1), Identify Types of Maps, EO M122.02 (Section 2), Identify Marginal Information and Conventional Signs, and EO M122.04 (Section 4), Orient a Map by Inspection. Refer to the specified Instructional Guides for further information.

ACTIVITY 3 – PHOTO NAVIGATION HUNT

The EO's covering the information required to conduct this exercise are EO M122.01 (Section 1), Identify Types of Maps, EO M122.02 (Section 2), Identify Marginal information and Conventional Signs, and EO M122.04 (Section 4), Orient a Map by Inspection. Refer to the specified Instructional Guides for further information.

ACTIVITY 4 – TRAIL MAP NAVIGATION

The EO's covering the information required to conduct this exercise are EO M122.01 (Section 1), Identify Types of Maps, EO M122.03 (Section 3), Interpret Contour Lines, and EO M122.05 (Section 5), Determine a Grid Reference. Refer to the specified Instructional Guides for further information.

ACTIVITY 1 – NAVIGATION USING A STREET MAP

Time: 90 min

OBJECTIVE

By the end of this activity the cadet shall be expected to be able to navigate using a street map.

RESOURCES

- Localized street maps for an optimal group size of four to six cadets.
- Detailed task placard for each checkpoint.
- Compass.

ACTIVITY LAYOUT

Using a street map, groups of four to six cadets will navigate within a 2 km radius of the corps location. Predetermined checkpoints set out on prominent objects, located 150 to 250 m apart, will have detailed navigation tasks at each point (e.g. fold a map, identify conventional signs, identify landform, relief type indicated, ect.), allowing cadets to practice skills taught. This activity shall be conducted in three 30 minute periods, allowing for a 15 minute debrief session.

SAFETY

Some rules are to be put in place to ensure the safety of cadets in populated areas with vehicle traffic, as this exercise will be conducted during evening hours. They shall include; but not be limited to:

- have set boundaries determined so cadets do not get lost;
- cadets shall obey all local laws and respect personal property;
- a staff member shall be present at each checkpoint; and
- have a set end time to return for debrief.

INSTRUCTOR GUIDELINES



At this point the instructor shall brief the cadets on any safety rules or any other guidelines pertaining to the activity.

- The instructor, with the assistance from senior cadets, shall supervise the cadets.
- A staff member shall be present at each checkpoint.
- Roaming advisor(s) shall move along the route to allow cadets to seek assistance if required.

ACTIVITY 2 – NAVIGATION SCAVENGER HUNT

Time: 90 min

OBJECTIVE

By the end of this activity the cadet should be more comfortable with navigating with a topographical map.

RESOURCES

- Topographical map.
- Compass.

ACTIVITY LAYOUT

Using a topographic map, groups of three to four cadets shall navigate to identified points on the map, and have the task of collecting items/information from these points (e.g. a napkin from a fast food location (with store's permission), river rock, phone number from a sign, etc.). Cadets are assigned points based on what items/information they are able to obtain. This activity shall be conducted in three 30 minute periods, allowing for a 15 minute debrief session.

SAFETY

Some rules are to be put in place to ensure the safety of cadets in populated areas with vehicle traffic, as this exercise will be conducted during evening hours. They shall include but not be limited to:

- have set boundaries determined so cadets do not get lost;
- cadets shall obey all local laws and respect personal property;
- a staff member shall be present at each checkpoint; and
- have a set end time to return for debrief.

INSTRUCTOR GUIDELINES



At this point the instructor shall brief the cadets on any safety rules or any other guidelines pertaining to the activity.

- The instructor, with the assistance from senior cadets, shall supervise the cadets.
- A staff member shall be present at each checkpoint.
- Roaming advisor(s) shall move along the route to allow cadets to seek assistance if required.

ACTIVITY 3 – PHOTO NAVIGATION HUNT

Time: 90 min

OBJECTIVE

By the end of this activity the cadet should be more comfortable navigating with a topographical map.

RESOURCES

- Topographical map.
- Compass.
- Romer.

ACTIVITY LAYOUT

Using a topographic map, groups of three to four cadets are given a handout showing a series of photos (e.g. sign, door, bridge, unique tree) taken in the local area. Cadets search out the location of the object in the photo, and record the six-figure grid reference of that location. Points are assigned based on difficulty of finding the object. This activity shall be conducted in three 30 minute periods, allowing for a 15 minute debrief session.

SAFETY

Some rules are to be put in place to ensure the safety of cadets in populated areas with vehicle traffic, as this exercise will be conducted during evening hours. They shall include but not be limited to:

- have set boundaries determined so cadets do not get lost;
- cadets shall obey all local laws and respect personal property;
- a staff member shall be present at each checkpoint; and
- have a set end time to return for debrief.

INSTRUCTOR GUIDELINES



At this point the instructor shall brief the cadets on any safety rules or any other guidelines pertaining to the activity.

- The instructor, with the assistance from senior cadets, shall supervise the cadets.
- A staff member shall be present at each checkpoint.
- Roaming advisor(s) shall move along the route to allow cadets to seek assistance if required.

ACTIVITY 4 – TRAIL MAP NAVIGATION

Time: 90 min

OBJECTIVE

By the end of this activity the cadet shall be expected to understand the layout and use of trail maps.

RESOURCES

- Localized map showing an organized trail system.
- Compass.

ACTIVITY LAYOUT

Using a trail section of a map, groups of three to six cadets follow a route along an organized trail system. This activity shall be conducted in three 30 minute periods, allowing for a 15 minute debrief session.

SAFETY

Some rules are to be put in place to ensure the safety of cadets if in areas with hiking and cycling traffic, as this exercise may be conducted during evening hours. They shall include but not be limited to:

- have set boundaries determined so cadets do not get lost;
- have a set safety bearing;
- cadets shall obey all local laws and respect personal property;
- a staff member shall be present at each checkpoint; and
- have a set end time to return for debrief.

INSTRUCTOR GUIDELINES



At this point the instructor shall brief the cadets on any safety rules or any other guidelines pertaining to the activity.

- The instructor, with the assistance from senior cadets, shall supervise the cadets.
- A staff member shall be present at each checkpoint.
- Roaming advisor(s) shall move along the route to allow cadets to seek assistance if required.

REFLECTION

Time: 15 min

GROUP DISCUSSION



Instructors shall ensure that all lesson objectives are drawn out towards the end of the reflection stage.

DISCUSSION QUESTIONS



TIPS FOR ANSWERING/FACILITATING DISCUSSION

- Ask questions that help facilitate discussion; in other words, avoid questions with yes or no answers.
- Prepare questions ahead of time.
- Be flexible (you are not bound to only the prepared questions).
- Encourage cadets to participate by using praise such as “great idea” or “excellent response, can anyone add to that?”
- Try to involve everyone by directing questions to non-participants.

SUGGESTED QUESTIONS

- Q1. What did this activity teach you about navigation?
- Q2. What did you enjoy most about this activity?
- Q3. What skills did you feel most comfortable using?
- Q4. What skills do you feel you require more practice with?



Other questions and answers will develop throughout the reflection stage. The discussion should not be limited to only those suggested. Cadets should be given sufficient time to tell stories of their adventures, and ask questions about any navigation issues that came up during the activity.

CONCLUSION

REVIEW

Upon completion of the group discussion, the instructor will conclude by summarizing to ensure that all points have been covered. The instructor must also take this opportunity to explain how the cadet will apply this knowledge and/or skill in the future.

MAIN TEACHING POINTS

Nil.

HOMEWORK/READING/PRACTICE

Nil.

METHOD OF EVALUATION

Nil.

CLOSING STATEMENT

Map reading is a skill, and true proficiency will only be achieved by practice on the ground. The skills you have learned during this PO can be used in situations outside of the Cadet Program as well. Practice makes perfect!

INSTRUCTOR NOTES/REMARKS

This complementary activity can be conducted more than once, in various forms over supported complementary days, or over sessions.

REFERENCES

A2-004 B-GL-382-005-FP-001 Canadian Forces. (1976). *Maps, Fields, Sketching, and Compasses* (Vol. 8). Ottawa, ON: National Defence.

CHAPTER 13
PO 123 – PARTICIPATE IN A DAY HIKE



ROYAL CANADIAN ARMY CADETS
GREEN STAR
INSTRUCTIONAL GUIDE



SECTION 1

EO M123.01 – SELECT HIKING CLOTHING AND EQUIPMENT

Total Time: 30 min

PREPARATION

PRE-LESSON INSTRUCTIONS

Resources needed for the delivery of this lesson are listed in the lesson specification located in A-CR-CCP-701/PG-001, *Green Star Qualification Standard and Plan*, Chapter 4. Specific uses for said resources are identified throughout the instructional guide within the TP for which they are required.

Review the lesson content and become familiar with the material prior to delivering the lesson.

PRE-LESSON ASSIGNMENT

Nil.

APPROACH

An interactive lecture was chosen for this lesson to introduce the cadets to hiking clothing and equipment.

INTRODUCTION

REVIEW

Nil.

OBJECTIVES

By the end of this lesson the cadet shall be expected to select appropriate day packs, water bottles, optional hiking gear and footwear prior to participating in a day hike.

IMPORTANCE

Cadets will be required to take part in many exercises while involved with the Army Cadet Program. It is important that, early in their training, cadets learn the skill of preparing their personal equipment for use during a hike.

Teaching Point 1**Identify the characteristics to consider when selecting a day pack.**

Time: 5 min

Method: Interactive Lecture

TYPES OF DAY PACKS

There are many devices made to assist in carrying loads on a hike or expedition. For day trips a small pack is required. It should comfortably hold everything desired for the hike, with a little extra capacity for winter jaunts. Some of these packs are:

- fanny packs (small packs);
- day packs; and
- backpacks.

Fanny Pack

The smallest category of pack for short hikes or hikes up to a few hours is a fanny pack. This pack is a small, unobtrusive pack that sits atop your buttocks, with a thin belt that clips around your waist. These are also known as waist, or lumbar, packs. The simplest of these packs consists of a pouch sewn to a piece of flat webbing, while the most elaborate ones hold upwards of 10 litres, and have padded belts and suspensions.

The fanny pack is lightweight, holds the load close to the spine, and to a person's centre of balance. When carrying articles with a fanny pack, the weight should be limited to 10 pounds.



www.mec.ca

Figure 1 Fanny Pack



www.abc-ofhiking.ca

Figure 2 Elaborate Fanny Pack

Day packs

Day packs are produced in numerous model types; however, all have shoulder straps and a waist belt. Most day packs have pockets for organizing your equipment and basic exterior features (i.e., axe loops and daisy chains).

Day packs may also come with an internal hydration system. This system provides a water bladder and hose exiting the top of the pack for easy access to water, or extra pockets for water bottles that are within easy reach when wearing the pack.

Models similar to those in Figures 3 and 4, allow for comfort while carrying loads up to 15 to 20 pounds.



www.mec.ca

Figure 3 Day Pack



www.mec.ca

Figure 4 Day Pack

IDEAL PACK PADDING

When properly adjusted, about two thirds of the pack's weight should ride on the hips, with the rest on your shoulders and upper back. Firm padding is mandatory for the following components:

- shoulder straps;
- waist belt; and
- back padding.

WAIST BAND

The waist band allows for the weight of a fanny pack, day pack, or backpack to rest on a person's hips and closer to the centre of gravity. The waist band, or hip belt, helps to make a pack's load more bearable. As the weight load increases, the effectiveness of the hip belt increases. Make sure the belt has soft, broad padding; heavier loads will cause the hip belt to slide down, so look for high-friction fabrics.

PACK CAPACITIES

As discussed, packs come in many different forms and sizes. The capacities of such packs differ with model type; however, there is a basic understanding that each type maintains a cubic inch capacity and weight association, as detailed in the following list:

1. fanny packs: Capacity of 10 litres; and
2. day pack: Capacity of 15 to 35 litres.

CONFIRMATION OF TEACHING POINT 1

QUESTIONS

- Q1. What are the three types of day packs available?
- Q2. Explain the difference between a fanny pack and a day pack.
- Q3. What is the ideal capacity of a fanny pack?

ANTICIPATED ANSWERS

- A1. Fanny packs (small packs), day packs, and backpacks.
- A2. A **day pack** has shoulder straps and a waist belt. Most day packs have pockets for organizing items and basic exterior features. A **fanny pack** is a small, unobtrusive pack that sits atop your buttocks, with a thin belt that clips around your waist.
- A3. Fanny packs: Capacity of 10 litres.

Teaching Point 2

Explain the optimum characteristics to consider when selecting hiking footwear.

Time: 10 min

Method: Interactive Lecture

BOOTS

The most important factor to consider when selecting backpacking footgear is fit. The footgear should be sufficiently sturdy to hold together throughout a trip. It should provide protection for the feet, and a firm foundation for walking and scrambling. Today's boots are derived from athletic shoe technology. They are light, comfortable and functionally suited. Common characteristics to look for when selecting a hiking boot are:

Sturdy. The boot should support feet and ankles from twisting on uneven surfaces. Higher boots with stiff ankle support provide lateral rigidity. The boot should also support the foot from over bending when placing too much weight on the toe or heel.

Lightweight. The lighter the boots the easier walking will be. Every extra pound of footwear weight can be compared to five pounds of added backpack weight.

Comfortable Fit. When worn, boots shall fit snugly with the heel snug against the wall of the shoe and a small amount of space for the toes to move.

Correct Size. Proper fitting boots ensure comfort during hiking. A boot fits correctly when:

- it is wide enough so the boot matches the width of the foot with little extra room;
- the tongue rests comfortably along the top of the toe; and
- the toes have room to wiggle.

SOCKS

The boot is only one part of the footwear system; socks are the first line of defence for the feet. A two-sock system is common in many activities. Unless hiking regularly in hot, damp conditions, consider wearing one pair of heavy socks and one pair of light inner socks. Always ensure socks are properly sized for the foot.

Inner Socks. This is a thin layer that helps wick, or pull moisture away, from the foot. They are usually made of a polypropylene material.

Outer Sock. This layer is most often made of wool or wool blend, which can absorb moisture. This layer cushions the foot and provides insulation.

CONFIRMATION OF TEACHING POINT 2

QUESTIONS

- Q1. What is the most important factor to consider when selecting footwear?
- Q2. Socks play what part in the footwear system?
- Q3. What is meant by wicking?

ANTICIPATED ANSWERS

- A1. The footwear's fit.
- A2. Socks are the first line of defence. They help remove moisture from the feet, and provide essential cushioning.
- A3. Wicking is the ability to pull moisture from the feet.

Teaching Point 3

Explain things to take into consideration during the selection of water bottles.

Time: 5 min

Method: Interactive Lecture

WATER BOTTLES

One indispensable item in any wilderness traveler's kit is a water bottle. Depending on the wilderness to provide drinkable water is a risk not worth taking. Hikers either have to purify water to make it drinkable, or carry water with them.

Types of Water Bottles. Depending on a person's requirements when going on a day hike, one must select a water bottle that most suits their personal choice, equipment no comma and capacity.

- **Canteen.** Simple water storage device, usually contains a litre of water.
- **Rectangular.** Rectangular wide mouth storage containers. Wide mouths are easy to fill, and allow easy mixing of water additives (purification tablets, juice crystals etc.).
- **Bottle Bag.** Water storage vessel, when empty can be rolled and stored using little space.
- **Water Bladder Pack.** Water is stored in a backpack bladder or just as a bladder pack. This bladder is capable of storing large amounts of water with ease ranging from ounces to litres.



www.abc-of-hiking.com

Figure 5 Canteen



www.mec.com

Figure 6 Rectangular Bottle



www.abc-of-hiking.com

Figure 7 Bottle Bag



www.outdooroutlet.com

Figure 8 Water Bladder Pack

Ideal Material Make Up. Water bottles can come in many forms, and be made of many materials. The optimum bottle is one that is easy to clean, does not pick up flavours easily, and is very durable. Of the many types of bottles available, Lexan and polycarbon bottles perform very well.

Wide Mouth Versus Narrow Mouth. The various constructions of water bottles have different advantages. The narrow mouth allows for slow pour and simple drinking. The wide mouth allows for fast pour and fill, mixing of additives, and allows for additional attachments (i.e., water purifier, mug mouth piece, drinking spouts, etc.).

Capacity Requirements. A hiker must plan water requirements, and determine what size of water storage vessel will be required for any hike. The absolute minimum amount of water a person needs under normal conditions is two litres per day. A person, when hiking, will require at least one litre every two hours. With increased exercise or temperature, fluid intake will increase.

CONFIRMATION OF TEACHING POINT 3

QUESTIONS

- Q1. What are the four types of water storage vessels?
- Q2. What are the advantages of a wide mouth bottle?
- Q3. What considerations should be taken when selecting a water bottle?

ANTICIPATED ANSWERS

- A1. Canteen, rectangular, bottle bag and water bladder pack.
- A2. The wide mouth allows for fast pour and fill, the mixing of additives, and for additional attachments (i.e., water purifier, mug mouth piece, drinking spouts etc.).
- A3. Capacity and durability.

Teaching Point 4**Explain the selection of optional hiking gear.**

Time: 5 min

Method: Interactive Lecture



This teaching point covers similar material cover in EO M121.04 (Chapter 11 [Section 4]), Assemble a Survival Kit. Many items one should bring on a hike can be contained in a survival kit. Some other points have also been discussed throughout field training. All points are relevant and should be reemphasized.

OPTIONAL HIKING GEAR

When participating in a hike there will be many items that may be of use depending on the route, terrain, and season of travel. Preparation of additional items for hiking will ensure an enjoyable trip.

Raingear. A lightweight raincoat in case of unexpected weather.

Hat. A wide brimmed hat will protect the back of the neck, ears, and face from burning.

Extra Insulation layer. A light down vest, sweater, or fleece jacket will provide insulation should the weather be cooler than expected, and during breaks when sweat evaporates and the body cools.

Sunglasses. Protect your eyes against damage from the sun's light (i.e., ultraviolet, bright or intense light, and blue light).

Sunscreen. Blocks or prevents the skin's exposure to the sun, or ultraviolet light. The skin will burn when the amount of exposure to the sun, or ultraviolet light source, exceeds the ability of the body's protective pigment to protect the skin. According to the Canadian Dermatology Association a minimum of SPF 15 with UVA and UVB protection should be worn.

Insect Repellent. Apply insect repellents to ward off unwanted insects. The repellent should be applied to the exposed areas of the body. Many insect repellents rely on chemicals such as DEET to repel insects and have effective durations per application.

WARNING

DEET in high concentrations can be harmful to a person's health, specifically the nervous system.

NOTE

Health Canada recommends:

- children under 6 months are NOT to use insect repellents containing DEET;
- children aged 6 months to two years are NOT to use insect repellents containing DEET;
- children between 2 to 12 years: apply no more than three times a day using the lowest concentration of DEET (10 percent or less); and
- individuals 12 years or older: apply insect repellents containing no more than 30 percent DEET.

Camera and Film. Many hikes into the wilderness will expose sites of pure beauty. Having a camera on hand to capture such moments will allow one to share, keep and record many moments.

Notebook and Pencil. Allows one to record hike details, route choice, memorable moments, injuries etc.

Bathing Suit and Towel. Many hikes into the wilderness will cross paths with rivers and bodies of water. One may want to stop and go for a swim or wash. Packing a bathing suit allows for that option when with a group.

Binoculars. Provides the ability to see far off objects and routes. One may want to view wildlife from a distance. This can be a very practical item in the field.

CONFIRMATION OF TEACHING POINT 4

QUESTIONS

- Q1. Name four optional hiking gear items.
- Q2. Why are sunglasses important?
- Q3. What is the minimum SPF number one should wear while exposed to sunlight?

ANTICIPATED ANSWERS

- A1. Any four of the following: Camera and film, notebook and pencil, bathing suit and towel, binoculars, sunglasses, sunscreen, and insect repellent.
- A2. Protect your eyes against damage from the sun's light.
- A3. A minimum of SPF number 15 with UVA and UVB protection should be worn.

END OF LESSON CONFIRMATION

QUESTIONS

- Q1. What is the most important factor to consider when selecting footwear?
- Q2. Socks play what part in the footwear system?
- Q3. What are the four types of water storage vessels?
- Q4. What are the advantages of a wide mouth bottle?

Q5. Name four optional hiking gear items.

Q6. Why are sunglasses important?

ANTICIPATED ANSWERS

A1. The footwear's fit.

A2. Socks are the first line of defence.

A3. Canteen, rectangular, bottle bag and water bladder pack.

A4. The wide mouth allows for fast pour and fill, mixing of additives, and for additional attachments (i.e. water purifier, mug mouth piece, drinking spouts, etc.).

A5. Any four of the following: Camera and film, notebook and pencil, bathing suit and towel, binoculars, sunglasses, sunscreen, and insect repellent.

A6. Protects your eyes against damage from the sun's light.

CONCLUSION

HOMEWORK/READING/PRACTICE

Nil.

METHOD OF EVALUATION

Nil.

CLOSING STATEMENT

Participating in hiking activities will be commonplace for Army Cadets. The ability to knowledgeably forecast required materials and items for a hike is important when cadets are required to prepare their own personal equipment for a hike.

INSTRUCTOR NOTES/REMARKS

This lesson shall be delivered prior to EO M123.02 (Participate in a Day Hike).

Instructors are encouraged to present locally available examples of hiking gear to better demonstrate the various styles and materials available.

REFERENCES

C2-012 (ISBN 0-89886-643-X) Weiss, H. (1988). *Secrets of Warmth for Comfort or Survival*. Seattle, WA: The Mountaineers.

C2-017 (ISBN 0-7627-0476-4) Roberts, H. (1999). *Basic Essentials, Backpacking*. Guilford, CT: The Globe Pequot Press.

THIS PAGE INTENTIONALLY LEFT BLANK



ROYAL CANADIAN ARMY CADETS
GREEN STAR
INSTRUCTIONAL GUIDE



SECTION 2
EO M123.02 – PARTICIPATE IN A DAY HIKE

Total Time: 9 x 30 min

PREPARATION

PRE-LESSON INSTRUCTIONS

Resources needed for the delivery of this lesson are listed in the lesson specification located in A-CR-CCP-701/PG-001, *Green Star Qualification Standard and Plan*, Chapter 4. Specific uses for said resources are identified throughout the instructional guide within the TP for which they are required.

Review the lesson content and become familiar with the material prior to delivering the lesson.

PRE-LESSON ASSIGNMENT

Cadets are required to plan their individual snacks as detailed by the instructor prior to the hike.

APPROACH

An experiential approach was chosen for this lesson as it allows the cadets to acquire new knowledge and skills through a direct experience. The cadets experience hiking and define that experience on a personal level. The cadets will be given the opportunity to reflect on and examine what they saw, felt and thought while hiking and consider how it relates to what they already learned and experienced as well as how it will relate to future experiences.

INTRODUCTION

REVIEW

The pertinent review for this lesson will include EO M123.01 (Section 1), Select Hiking Clothing and Equipment.

QUESTIONS

- Q1. What is the most important factor to consider when selecting footwear?
- Q2. What are the four types of water storage vessels?
- Q3. Why are sunglasses important?

ANTICIPATED ANSWERS

- A1. The footwear's fit.
- A2. Canteen, rectangular, bottle bag and water bladder pack.
- A3. Protects your eyes against damage from the sun's light.

OBJECTIVES

By the end of this lesson, the cadet shall be expected to participate in a day hike, where they will determine personal food requirements and follow a leader during a day hike.

IMPORTANCE

The day hike allows the cadet to participate in physical fitness while challenging themselves and having fun. It introduces the Green Star Cadet to the necessary skills required for progressing through the hiking aspect of the Army Cadet Program.

Teaching Point 1

Describe trail etiquette methods that accomplish the “leave no trace” ideologies while hiking.

Time: 10 min

Method: Group Discussion



This teaching point is to be presented as a group discussion during a break in the hike. All material and information is provided for the purpose of educating the instructors. The instructor will be required to review the information and in a group environment, discuss the points presented and ensure comprehension of material.

Trekkers have always known, that proper planning before entering an outdoor environment serves as one of the key elements in having a safe and successful trip. No trace camping also involves avoiding or reducing the damage caused by humans frequenting the environment. Preparing for an environmentally sound outdoor experience includes following the “leave no trace” guidelines that are listed in the following paragraphs.

Repackaging Food Before Leaving on a hike will greatly reduce weight and the likelihood of litter, broken glass, and surprise openings and spillage in your pack. Repackaging food requires the removal of food from cardboard boxes and placing it in reusable zipper bags, and emptying contents from glass containers and placing them into reusable plastic containers.

If you have something that has special instructions for its preparation, clip it out and put it in the plastic bag. Be sure the plastic bags are of at least two-ply strength. For liquids like soy sauce, cooking oil and vinegar, plastic Lexan or polycarbon bottles with screw tops work well.

Staying on Established Trails helps limit the amount of overall erosion caused by constant trampling and travel over environmental surfaces. Avoid taking shortcuts and, when travelling cross-country where no trails exist, try and remain on the most durable surfaces.

Walking on Durable Surfaces will help maintain the natural beauty of the area. Surfaces vary from soft marshes to solid rock, and trekkers will continuously cross many different types of terrain. It is imperative to take the time to travel on surfaces that will not be significantly affected, rather than taking the straightest line to get to a destination, trampling whatever lies in the way.

Travel in Small Groups as increased group numbers can have a greater impact than smaller ones. Stick to appropriate group sizes of 10 or less. Understand that every action has the potential to impact the natural environment. Take the necessary precautions to protect the environment when travelling in a group.

Avoid Making Loud Noise and allow nature’s sounds to prevail when travelling through the wilderness. Avoid using loud voices and making loud noises, secure all pots and pans on the backpack and only use the whistle in emergency situations.

CONFIRMATION OF TEACHING POINT 1

QUESTIONS

- Q1. Why should a trekker repack food before going on a hike?
- Q2. What surfaces should one walk on while travelling in the field?
- Q3. Why should trekkers stay on established trails?

ANTICIPATED ANSWERS

- A1. To greatly reduce weight and the likelihood of litter, broken glass, and “surprise openings and spillage” in ones pack.
- A2. Durable surfaces.
- A3. Remaining on established trails helps limit the amount of overall erosion caused by constant trampling and travel over environmental surfaces.

Teaching Point 2

Describe preventative action that should be taken for physical conditions that may develop when hiking.

Time: 10 min

Method: Interactive Lecture

BLISTERS



This teaching point is to be presented as a group discussion during breaks in the hike. The following material and information is provided for the purpose of educating the instructors. The instructor will be required to review the information and, in a group environment, discuss the points presented and ensure comprehension of material.

A blister is a small bubble on the skin filled with fluid caused by friction (see Figures 1 and 2). It is basically the body’s way of saying the boots don’t fit, they are not broken in, or the feet are still to tender for the miles being covered.



www.bannoy.com/images/blog/heel_blisters.jpg

Figure 1 Heel Blister



www.windspirit.co.za/images/blisters/.jpg

Figure 2 Heel Arch Blister

Preventing Blisters. To prevent blisters a hiker must ensure:

- proper boot fit;
- multiple sock layers (multiple layers wick moisture and minimize direct rubbing on the skin);
- foot powder is applied prior to and during hiking; and
- to address hot spots as they arise.



It is especially important to stop and take care of feet early in the trip when feet become tender. By taking boots and socks off at rest breaks, the hiker will have an opportunity to cool feet, apply foot powder and look for red areas which may indicate oncoming hotspots.

Treating Blisters. If a blister develops there are two solutions to help relieve the pressure:

1. Cut a piece of moleskin that generously covers the blister. Cut a smaller hole in the moleskin, making a little donut shape. The donut should fit around the blister, the idea being that the moleskin relieves the pressure from the injury. Fill the moleskin donut with an antibiotic cream and cover the whole donut with athletic tape.
2. Use 2nd skin directly over the blister, followed by a layer of moleskin to keep the second skin in place. Second skin is a padding that has high water content and has a slimy feel, giving it a lubricating quality.



If a blister develops into a full bubble it may be necessary to lance the blister. Determining whether to lance a blister is complicated; a drained blister increases the chance of infection. The rule of thumb to follow is if a blister is smaller than a nickel do not drain it and follow the steps above; however, if it is bigger than a nickel it will have to be drained as it will most likely pop anyways. Once drained ensure to apply an antibiotic cream/ointment to the area to ward off infection and then follow the steps above.

HOT SPOTS

Hot spots are the precursor to blisters. The slight reddening of the skin and early hints of pain are telling signs of an impending blister (a hot spot). This reddening is the result of friction, between the skin and the sock or boot/liner. To avoid blisters, stop and address hot spot(s). The best action is to tape the spot with moleskin or athletic tape. Use a tincture of benzoin, if available, and place the tape carefully over the area.

Prevention. Same as blisters, as hot spots will lead to a blister.

PLANTAR FASCIITIS

Plantar fasciitis (fashee-EYE-tiss) is an overuse injury affecting the sole or flexor surface (plantar) of the foot. A diagnosis of plantar fasciitis means one has inflamed the tough, fibrous band of tissue connecting the heel bone to the base of the toes. This condition occurs in people who excessively run or walk, stand on hard surfaces for prolonged times, or people with very flat feet or very high arches. This condition starts gradually with mild pain at the heel bone. One is more likely to feel it after exercise.



www.posetech.com/training/images/plantar-faciitis-smi.gif

Figure 3 Plantar Fasciitis-A



www.patient.co.uk/showdoc/pilsin/017.jpg

Figure 4 Plantar Fasciitis-B



IF YOUR FOOT FLATTENS TOO MUCH, THE PLANTAR FASCIA MAY OVERSTRETCH AND BECOME INFLAMED.



IF YOUR FOOT DOESN'T FLATTEN, THE PLANTAR FASCIA MAY BE PULLED TOO TIGHT, EVENTUALLY CAUSING PAIN.

www.patient.co.uk/showdoc/pilsin/017.jpg

Figure 5 Flat Foot/High Arch Foot

Prevention. There are several things you can do to prevent plantar fasciitis including:

- wear proper footwear for the activity;
- stretch (tight and cold muscles are prone to injury); and
- condition the body in a progressive manner when preparing for activities that will see the trekker covering great distances on foot.

Treatment. Rest and keep weight off the foot until inflammation goes away, and apply ice to the area for 20 min three or four times daily. Stretching your Achilles tendon and plantar fascia are the mainstay of treating the condition.

SHIN SPLINTS

Excess training with inadequate recovery causes shin splints; over running is most often the culprit. Shin splint occurs when the foot strikes the ground, followed by a loading/energy transfer phase, and finally a push off with the forefoot. Each foot strike delivers a shockwave that travels up the leg. This energy is absorbed by the musculoskeletal system. The harder the running surface the greater the shockwave (i.e., soft grass, smooth dirt, asphalt, and concrete represent increasing hardness, concrete being the hardest).

Symptoms. In the early stages of shin splints a runner will describe a pain that is present when the training run first begins, then disappears as running continues. The pain will often return after exercise or the following morning. Eventually, if ignored and training continues, the pain may become quite sharp and may focus on a very small area of the bone. If this happens a stress fracture may be present.

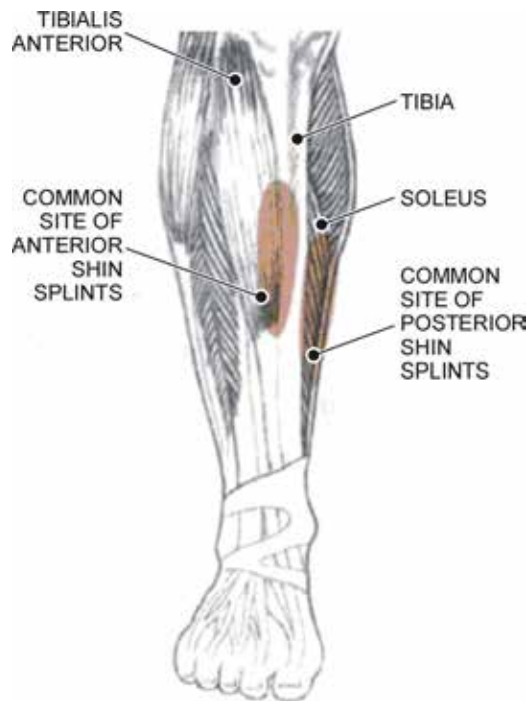

www.athleticadvisor.com/images/LE_images/shin-splints.gif

Figure 6 Shin Splints

Prevention. There are several things you can do to prevent shin splints:

- overstriding when hiking occurs when a person throws the leg out too far in front, unnaturally lengthening the stride. To correct, slow down and try to push off with back foot rather than extending the front leg. The lead leg should strike closer to the body, roll through the step, and push off with the toe. Note the extension should be in the back, not in the front;
- avoid wearing footwear with a high heel;
- wear proper footwear for activity – over-pronation rolls the foot inward on each step. Get fitted with motion control running shoes;
- stretch (tight and cold muscles are prone to injury); and
- condition the body by beginning with activities that cover distance in a progressive manner. If hiking, beginning training with short distance hikes progressing to longer distances over time.

Treatment. Rest, and depending on the severity, it is often necessary to completely stop running for a period of time. When running is resumed, a significant change in routine must be adhered to or else the injury will return. Lengthen the time between training and decrease the volume and intensity of training.

MUSCLE CRAMPS

A cramp is a muscle spasm that occurs when the blood circulation is impaired or if the muscle is over exerted. It usually occurs in the leg and may develop when swimming in cold water. It can happen when a person is immobile in a “cramped” position. This commonly occurs while sleeping.

Heat Cramps are caused by the loss of salt when there is excessive sweating. The lack of salt causes cramps that are spasmodic, painful contractions of muscles, usually in the leg.

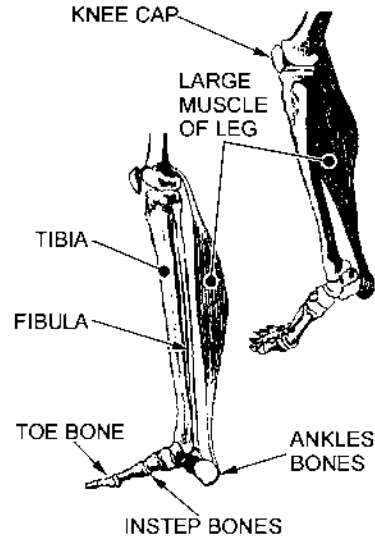

Camping & Wilderness Survival, The Ultimate Outdoors Book, p.311

Figure 7 Muscle Cramps

Prevention. To reduce the probability of these cramps:

- eat well-balanced meals rich in potassium and sodium (i.e., eggs, liver, chicken, milk, citrus fruits, bananas and dark green leafy vegetables); and
- stay well hydrated.

Treatment. A victim of an attack should rest in a cool area and drink a saline solution or lemonade. Avoid cramps by warming up before strenuous activity. During an attack stretch out the muscle while massaging above the painful area to increase the flow of blood.

SPRAINS

A sprain is the ligament of a joint that is torn by a sudden twist or wrench. The joint is very painful when moved, and there can be considerable swelling. A deep bruise may gradually appear. A bad sprain is hard to distinguish from a fracture. To treat a sprain, wrap the sprained joint in a heavy bandage. Rest the limb in a comfortable elevated position.

Prevention. To reduce the probability of sprains:

- stretch before and after exercising. Tight muscles pull on the Achilles tendon and can reduce the range of motion of the foot;
- select footwear with good ankle support – wear snugly laced, high-topped shoes; and
- select footing carefully while on uneven surfaces.

Treatment. **RICE** (Rest, Ice, Compression, and Elevation) is key to rapid healing.

CONFIRMATION OF TEACHING POINT 2

QUESTIONS

- Q1. What is a blister?
- Q2. How should shin splints be treated?
- Q3. What causes muscle cramps?

ANTICIPATED ANSWERS

- A1. A blister is a small bubble on the skin, filled with fluid and caused by friction.
- A2. Rest, and depending on the severity, it is often necessary to completely stop running for a period of time. When running is resumed, a significant change in routine must be adhered to or else the injury will return. Lengthen the time between training and decrease the volume and intensity of training.
- A3. A cramp is a muscle spasm which occurs when the blood circulation is impaired or if the muscle is over exerted.

Teaching Point 3

Explain and demonstrate how to develop a personal hiking rhythm that will increase performance and endurance.

Time: 10 min

Method: Demonstration and Performance



The instructor will, during a hike, choose appropriate times to show the cadets how to develop a personal rhythm when hiking, keeping in mind the whole purpose of the teaching point is for the cadets to learn how to develop and maintain a personal rhythm.

Sample method: The instructor may want to briefly discuss keeping a hiking rhythm that is conducive to the group prior to the hike. For the first hour, hike a little slower than normal, allowing cadets to get used to the trail with a slower pace. During the first break, discuss determining rhythm. During the second leg, intentionally increase the pace to the point of tiring the cadets. During the second rest, discuss the differences in both legs and determine a pace that will maintain a good rhythm for the duration of the hike, employing the guidelines of establishing a rhythm.

An average day of hiking will consist of periods of hiking and periods of rest. The combination of good hiking rhythm, good walking speed, and fixed rest intervals are things that separate hiking beginners from good hikers. Enthusiasm often tends to cause one to start too fast, get tired quickly, take an early rest, and start off too fast again.

DETERMINING STRIDE RHYTHM AND SPEED

A steady hiking rhythm is generally more enjoyable as one over exerts themselves less and generally keeps the physical strain at enjoyable levels. Having a steady rhythm will enable a hiker to stick to a fixed schedule and lessen the strain put on the feet, legs, lungs and overall body. This allows a hiker to travel while being less fatigued.

Developing a Hiking Rhythm. A hiking rhythm is very personal and is developed over the course of many hikes. To develop a rhythm there are some guidelines to follow:

- choose a specific stride rhythm and speed and keep to it. A good rhythm is one that allows a hiker to hike at the same intensity level for at least one hour without having to take a break;
- adjust rhythm to terrain, weather and weight. The point where a person can no longer carry on a conversation indicates the hiker has gone beyond a comfortable tempo;
- make the rhythm a full body movement where breathing and the swing of the arms happen in harmony with the body; and
- uneven surfaces like uphill and downhill slopes of varying incline can make it difficult to maintain a steady hiking rhythm.

CONTROLLING FATIGUE

The purpose of resting is to slow down the heart rate and breathing, thereby allowing the heart and lungs to rest. Resting gives the body time to get rid of the lactic acids built up in muscles, and to recover from hot spots or sores.

Resting guidelines:

- rest in regular intervals; try 10 minutes for every hour hiked (make them part of the rhythm);
- stick to 10 minutes rest breaks. Use only lunch and dinner (supper) breaks as extended rest periods;
- 10 minutes is the most effective rest duration for body recovery;
- ensure to take off backpacks, rest in the shade, and sit down during rests; and
- during the extended rest breaks, allow feet to rest and dry by removing shoes, and airing out footwear.

ADJUSTING RHYTHM

Generally, hiking rhythm on a flat surface can be maintained easily; however, when weather and additional weight are included, hiking becomes more difficult. How fast travel is depends on the fitness level of the entire group, the terrain, the altitude and pack weight. One of the best ways to measure and regulate pace is to pay close attention to the tempo of breathing.

If breathing determines pace then, for example, on level ground one takes three steps per inhalation, and three steps per exhalation. Climbing a hill, while maintaining the same breathing rate, the steps per inhalation fall to two steps. A good rule of thumb to follow is to walk at a pace where one can still carry on a conversation.

When travelling in different conditions ones pace will change, according to:

- **Weather.** Poor weather will reduce pace and force the hiker to reduce step size for safety.
- **Weight.** Weight will affect pace size as the more weight one carries the more energy must be expelled.
- **Terrain.** Travelling up hill will reduce pace size and distance traveled.

EMPLOYING FULL BODY SYNCHRONIZATION

Hiking rhythm is a full body affair. Just like marching, hiking requires coordinated movements where every action has a reaction. The swing of arms provides momentum, breathing controls pace etc. To properly control rhythm, one must first learn what body parts work in unison with each other.

To employ full body synchronization during movement, the arms should be in motion at a natural swing opposite to the forward foot. The swing of the arms provides momentum to help carry the body forward for the next step. Breathing will control pace (keeping in mind a good rhythm is when a person can carry on a conversation while hiking).

CONFIRMATION OF TEACHING POINT 3

This teaching point will be confirmed throughout the duration of the hike. The instructor will constantly be supervising and providing advice to cadets who experience difficulty.

Teaching Point 4

Discuss the purpose of resting intervals during heavy hiking periods.

Time: 10 min

Method: Interactive Lecture



This teaching point is to be presented as a group discussion during breaks in the hike. The following material and information is provided solely for the purpose of educating instructors. The instructor will be required to review the information, and in a group environment, discuss the points presented and ensure comprehension of material.

RESTING INTERVALS

An average day of hiking consists of periods of hiking and of resting. Resting intervals should occur once every hour, for a duration of 10 minutes, in an area that is conveniently shaded and possibly near a water source. During the first 5 to 7 minutes of resting, the body flushes out about 30 percent of the lactic acid build-up in the muscles, but only five percent in the next 15 minutes (be cautious rest does not extend beyond 10 minutes).

Rests also provide the body with much needed breaks. In addition to lactic acid build-up in the muscles, the body works in unison and other areas may become fatigued. By resting:

- the heart rate slows and beats at a reduced rate;
- the lungs supply less oxygen to the body;
- the body and mind rest; and
- feet and footwear can be aired out, reducing the chance of blisters.

CONFIRMATION OF TEACHING POINT 4

QUESTIONS

- Q1. How long should rest intervals be?
- Q2. How much lactic acid is flushed from the muscles during the first five to seven min of a break/rest?
- Q3. What other parts of the body are provided with a rest during a break?

ANTICIPATED ANSWERS

- A1. 10 min.
- A2. 30 percent.
- A3. The heart, lungs, feet and mind.

Teaching Point 5**Explain the selection of food rations that can be consumed during a day hike.**

Time: 10 min

Method: Interactive Lecture



This teaching point is to be presented as a group discussion during breaks in the hike. The following material and information provided is for the purpose of educating instructors. The instructor will be required to review the information and, in a group environment, discuss the points presented and ensure comprehension of material.

TYPES OF RATIONS

Staple Foods. This type of meal is made up of food such as pastas, flour, dried beans, rice, sugar, potatoes etc. This type of food in comparison to others is:

- cheaper than freeze-dried meals;
- easier to find as it is available at any grocer; and
- more flexible as it allows one to pick and choose ingredients when preparing a meal.

Freeze Dried. This is a preserved food that has gone through a process that freezes and dries the food before it is packaged. To prepare such a food, just add hot water. This form of meal in comparison to others is:

- expensive;
- light in weight;
- non-perishable; and
- convenient to prepare.

Trail Food. This is a quick snacking food which is easy to eat while on the trail. Providing a quick fix for hunger prior to a main mealtime, trail food consists of nuts and seeds, dried fruits, energy bars and fruit bars, breadstuffs, trail mixes, etc. This form of meal, in comparison to others, is:

- easily accessible;
- small and snackable; and
- requires no preparation.

EATING FREQUENCY

The average person in the field eats between 1.5 and 2.5 lb of food each day, or between 2500 and 4500 calories. Planning the amount of food to bring can be a daunting task; if one packs too much it will have to be carried, if one brings too little one may be forced to find alternate food sources.

How much food is required depends on how strenuous of a trip is planned. A person will eat less while hiking on light days in the summer than when skiing in the winter. One would also eat more on a climbing trip than on a fishing trip. To determine the amount of food reference the table provided below.

Ration Table	Average Wilderness Activities (Backpacking or Kayaking)	Strenuous Wilderness Activities (Snow Camping)	Very Strenuous Activities (Extreme Mountaineering)
Pounds per Person per Day	1.5 to 2 lb	2 to 2.25 lb	2.25 to 2.5 lb
Calories per Person per Day	2500 to 3000 calories	3000 to 3700 calories	3700 to 4500 calories

Keeping in mind the weight in food should be split between trail foods and stable foods. Plan meals individually, and carefully, to determine what will be required on the trip.

CONFIRMATION OF TEACHING POINT 5

QUESTIONS

- Q1. How many calories can a person burn a day when participating in strenuous wilderness activities?
- Q2. How many pounds of food does one consume per day of backpacking?
- Q3. How should you plan your meals for the trip?

ANTICIPATED ANSWERS

- A1. 2500 to 3000.
- A2. 1.5 to 2 lb.
- A3. Individually.

Teaching Point 6

Explain potable water requirements for consumption during a day hike.

Time: 15 min

Method: Interactive Lecture

DAILY WATER REQUIREMENTS



The instructor shall ask the following lead in question: What are some ways we lose water from our bodies?

The instructor should draw the following information from the group. The instructor should then present anything not provided by the group.

The human body constantly loses water from sweating, urinating, breathing and defecating. When the body is working hard and sweating heavily, we can lose up to a litre of water per hour. At high altitudes where the air is dry, a person can dehydrate by merely breathing at rest.

Performance Related Water Loss. Dehydration impairs humans both physically and mentally. As a person becomes dehydrated, the blood plasma level lowers (blood becomes thicker) and consequently, the heart has to work harder to pump blood. As the body becomes increasingly dehydrated, complications occur, such as:

- a decrease in cardiovascular performance (person finds it harder to catch their breath);
- the body is less able to dissipate heat through sweat;
- the ability to digest and metabolize food is impaired; and
- physical performance declines.

Pre-hydration is the key to staying hydrated. When a person becomes thirsty the body is already showing signs of dehydration. Drinking extra water before strenuous activities will also help performance. The best fluid to maintain hydration is water.

Note: Caffeine and carbonated drinks accelerate dehydration.

Daily Water Intake by Weight. To stay hydrated, daily intake levels have been produced based on body weight. Reference the chart below.

RECOMMENDED DAILY WATER INTAKE ACCORDING TO WEIGHT

Body Weight (lb)	Litres of Water at Rest
100	3
120	3.6
140	4.2
160	4.8
180	5.4
200	6

MAINTAINING SAFE HYDRATION LEVELS

Motorized cars require oil to lubricate a combustion engine. Just like a car, the human body requires lubricant in the form of **WATER** to run its engine. To keep this engine running effectively a person must maintain a safe hydration level by:

- **Pre-hydrating.** Drinking extra water before you start activity.
- **Drinking Small Amounts Often.** Small amounts will effectively feed the engine constantly.
- **Drinking Cool Water.** The intestines absorb cool water more easily.
- **Avoiding Sugary Drinks.** Sugar impedes the body's ability to absorb fluid.
- **Making Drinking Water a Habit.** A good habit is never forgotten.
- **Drinking at Least 8 oz of Water.** For every half hour of strenuous activity.

LOCATING WATER SOURCES FROM WHICH WATER CAN BE DRAWN AND PURIFIED



The instructor shall ask the following lead in question: What are some sources of water found in nature?

The instructor should draw the following information from the group. The instructor should then present anything not provided by the group.

Water is essential to life. All life depends upon it and all living things contain it. The average person can survive for three weeks without food, but only three days without water. It is the number one priority. When in the field, one must know where to locate water in the case of emergency.

The first place to look is:

- **Rivers.** A common source of water, one should draw the water from flowing water away from the banks.
- **Streams.** A common source of water, one should draw the water from flowing water away from the banks.
- **Lakes/Ponds.** A common source of water, one should draw from deeper areas of the source.
- **Valley Bottoms.** Water naturally drains into these areas from surrounding heights.
- **Patches of Green Vegetation.** These indicate a water source. One can dig below the surface to locate water if it is not visible on the surface.
- **Dry Streams or Riverbeds.** Even though a stream might be dry on the surface water may still be flowing below the surface in a spring. Dig down to locate water.



When collecting water from the natural environment for consumption, it is important to ensure the water is safe to drink. Be sure to boil or filter water through a water purifier, or use water purification tablets.

CONFIRMATION OF TEACHING POINT 6

QUESTIONS

- Q1. If a person weighed 140 lb, how much water would be required to maintain daily hydration levels at rest?
- Q2. How does the human body lose water?
- Q3. During a hike you drop your water bottle. You are becoming thirsty and see no lakes or streams in sight. Where may you locate water?

ANTICIPATED ANSWERS

- A1. 4.2 litres.
- A2. The human body constantly loses water from sweating, urinating, breathing, and defecating.
- A3. Valley bottoms, patches of green vegetation, dry streams or riverbeds under the surface.

END OF LESSON CONFIRMATION

QUESTIONS

- Q1. Why should a trekker repack food before going on a hike?
- Q2. What surfaces should one walk on while travelling in the field?
- Q3. How many calories can a person burn a day when backpacking through the wilderness?
- Q4. How many pounds of food does one eat per day in the field?
- Q5. How should shin splints be treated?

ANTICIPATED ANSWERS

- A1. To greatly reduce weight and the likelihood of litter, broken glass, and “surprise openings and spillage” in ones pack.
- A2. Durable surfaces.
- A3. 2500 to 3000.
- A4. 1.5 to 2 lb.
- A5. Rest and depending on the severity, it is often necessary to completely stop running for a period of time. When running is resumed a significant change in routine must be adhered to or else the injury will return. Lengthen the time between training and decrease the volume and intensity of training.

CONCLUSION

HOMEWORK/READING/PRACTICE

Cadets will be required to develop, and practice a personal hiking rhythm on subsequent hikes.

METHOD OF EVALUATION

Nil.

CLOSING STATEMENT

This activity has provided the cadets with an opportunity to participate in physical fitness, while challenging them to develop the necessary skills required to progress through the Army Cadet Hiking Program.

INSTRUCTOR NOTES/REMARKS

To deliver this lesson, the instructor shall take advantage of teachable moments and rest stops, to allow cadets to relate to the material being taught.

It is necessary that cadets' characteristics be taken into consideration when selecting the hiking route.

EO M123.01 (Select Hiking Clothing and Equipment) shall be completed prior to this lesson.

REFERENCES

C2-009 (ISBN 0-684-85909-2) Harvey, M. (1999). *The National Outdoor Leadership School's Wilderness Guide*. New York, NY: Fireside.

C2-010 (ISBN 0-375-70323-3) Rawlins, C., and Fletcher, C. (2004). *The Complete Walker IV*. New York, NY: Alfred A. Knopf.

C2-034 (ISBN 0-87322-637-2) Priest, S., and Gass, M. (2005). *Effective Leadership in Adventure Programming* (2nd ed.). Windsor ON: Human Kinetics Publishing Inc.

THIS PAGE INTENTIONALLY LEFT BLANK



ROYAL CANADIAN ARMY CADETS
GREEN STAR
INSTRUCTIONAL GUIDE



SECTION 3

EO C123.01 – PARTICIPATE IN ADVENTURE TRAINING

Total Time:

540 min

No instructional guide is provided for this EO, refer to A-CR-CCP-951/PT-002, *Royal Canadian Army Cadets Adventure Training Safety Standards*, for activities.

THIS PAGE INTENTIONALLY LEFT BLANK



ROYAL CANADIAN ARMY CADETS
GREEN STAR
INSTRUCTIONAL GUIDE



SECTION 4

EO C123.02 – EXPLAIN SNOWSHOE MARCH DISCIPLINE

Total Time: 30 min

PREPARATION

PRE-LESSON INSTRUCTIONS

Resources needed for the delivery of this lesson are listed in the lesson specification located in A-CR-CCP-701/PG-001, *Green Star Qualification Standard and Plan*, Chapter 4. Specific uses for said resources are identified throughout the instructional guide within the TP for which they are required.

Review the lesson content and become familiar with the material prior to delivering the lesson.

PRE-LESSON ASSIGNMENT

Nil.

APPROACH

An interactive lecture was chosen for this lesson to introduce the cadets to snowshoe march discipline.

INTRODUCTION

REVIEW

Nil.

OBJECTIVES

By the end of this lesson the cadet shall be expected to explain the principles of march discipline.

IMPORTANCE

Cadets need to know how to adhere to the rules and principles of march discipline while participating in a march on a winter FTX in order to remain comfortable, safe and effective during cold weather training.

Teaching Point 1**Explain points to consider before embarking on a winter hike.**

Time: 10 min

Method: Interactive Lecture

POINTS TO CONSIDER BEFORE EMBARKING ON A WINTER HIKE

March discipline is the observance of the drills and precautions taken before, during, and after a march to ensure that a group of cadets arrives at a destination fully equipped, and capable of carrying out further training. It involves a number of things such as adequate march control, care of equipment, obedience to march instructions, proper conduct and performance of duty, suitable formations, suitable rate of march, correct distances and effective use of cover and concealment.

March discipline in the winter is basically the same as it is in warm weather, but severe cold and snow are factors that must be taken into consideration.

Dress. Dress should be as light as possible, and consistent with the weather. Choice of footwear will vary depending on the temperature. When temperatures are likely to go above the freezing point, a boot appropriate for wet-cold conditions should be worn instead of mukluks.

Hiking Route. Before the march begins, the route must be planned in detail. The easiest route, consistent with training required, should be chosen. Obstacles such as open water, rocky or hilly terrain, soft snow etc., should be avoided when possible. Route cards may be passed out to cadets. Cadets should be given the route in a briefing before the winter hike begins.

Trail Breakers. The purpose of trail breaking is to make the march of the main body as easy and quick as possible. It is a difficult and time-consuming job. Arrangements for a system of relief of tasks - or trading up of tasks - should be made in advance. The progress of trail breaking depends on such things as terrain, weather, snow conditions, vegetation, and physical condition of the trail breaking party.



Instructors and supervisors should be aware of any medical or physical conditions of their cadets that will require extra supervision or attention before beginning any hike or march.

CONFIRMATION OF TEACHING POINT 1

QUESTIONS

- Q1. What is march discipline?
- Q2. What kind of obstacles should be avoided while on a winter march?
- Q3. What is the purpose of trailbreakers?

ANTICIPATED ANSWERS

- A1. March discipline is the observance of the drills and precautions taken before, during, and after a march to ensure that a body of cadets arrives at a destination fully equipped, capable of carrying out further tasks.
- A2. Obstacles such as open water, rocky or hilly terrain, and soft snow should be avoided on a winter march.
- A3. The purpose of trail breaking is to make the march of the main body as easy and as fast as possible.

Teaching Point 2**Explain points to consider when on a winter hike.**

Time: 10 min

Method: Interactive Lecture

REST PERIODS

There is a requirement for multiple rest stops while on any hike. This need is amplified by the special factors brought about by the cold.

Equipment and Clothing Checks. Ten to 15 min after the march begins, a rest must be taken to adjust equipment and clothing.

Physical Breaks. Subsequent halts should be taken often but should be short, merely long enough to allow a short rest or change of duties, but not long enough to get chilled. Two to three minute breaks every 15 to 20 min should be taken.

Refreshments. Hot drinks should be prepared before the march, and taken in thermos bottles. Cadets should be encouraged to drink them during rest periods.

Frostbite Checks. These need to be carried out day and night. During the day, the “buddy” system should be used to check for frostbite during the march and during rests. At night, it is mostly the individual's responsibility to check if there is no light. If there is an adequate light source, then the “buddy” system should be used as well.

Windbreaks. If hiking in the wind, rests can be taken and the backpack used as a windbreak. During long rests, windbreaks can be constructed by snow blocks, trees, etc.

MARCH FORMATIONS

These will vary and change depending on what the cadets are doing.

Single File. Normally during marches, the best formation to adopt is single file since it maintains track discipline, reduces the number of trailbreakers, and makes pulling a toboggan on a broken trail easier.

Parallel Columns. On firmly packed snow where there is no need to break a trail, you will probably find it better to travel in parallel columns as it lets you travel faster.

To keep a group together in single file it is a good policy to make each person responsible for the person directly behind them. This way a cadet stopping in the rear of the group will automatically stop the entire group.



Cadets should know that they should not wait until the next scheduled rest to inform a supervisor that they are extremely cold, sick, or that they may be injured.

CONFIRMATION OF TEACHING POINT 2

QUESTIONS

- Q1. When should the first clothing and equipment check be made?
- Q2. How long should physical breaks be?
- Q3. What is the best system for checking for frostbite?

ANTICIPATED ANSWERS

- A1. 15 to 20 min after the march begins.
- A2. 2 to 3 min.
- A3. The buddy system.

Teaching Point 3

Explain considerations to take when finished a winter hike.

Time: 5 min

Method: Interactive Lecture

MEDICAL INSPECTIONS

When the march is completed and the destination is reached, march discipline must continue. Like the rest periods during the march, there are checks that should be done at the end.

Frostbite Checks. Checks for frostbite should be performed using the “buddy” system, first to all skin that is visible. An individual check should be done after to ensure that there is no frostbite in other parts of the body not visible to your buddy on the march.

Body Injuries. Instructors and supervisors will check the cadets for any injuries that may have occurred during the course of the march. These injuries include things such as blisters, sore feet, sprains, extreme fatigue, etc.

Cold and Flu Symptoms. Instructors and supervisors will check cadets to see if there are any cadets who have signs and symptoms of the cold and flu such as coughing, wheezing, sneezing, runny nose, congestion, etc.



Instructors and supervisors should physically check cadets' feet, hands, etc., for frostbite and injuries because cadets do not always report sickness and injuries when they feel them.

CONFIRMATION OF TEACHING POINT 3

QUESTIONS

- Q1. True or false: When the march is finished, march discipline is also finished?
- Q2. What are some injuries that instructors should look for on cadets?
- Q3. What are some of the signs and symptoms of a cold or flu that supervisors should look for?

ANTICIPATED ANSWERS

- A1. No, even when the march is over, march discipline must continue.
- A2. Blisters, sore feet, sprains, extreme fatigue, etc.
- A3. Supervisors should look for coughing, wheezing, sneezing, runny nose, congestion, etc.

CONCLUSION

HOMEWORK/READING/PRACTICE

Nil.

METHOD OF EVALUATION

Instructors will confirm the cadets' ability to adhere to march discipline while participating in a winter march.

CLOSING STATEMENT

During winter field training, as with any cadet activity, safety is of paramount importance. Following pre-established rules for march discipline, and reacting to additional orders in a timely fashion, will allow for a more enjoyable, safer training experience for all.

INSTRUCTOR NOTES/REMARKS

This lesson is best delivered under the supervision of a cold weather instructor.

REFERENCES

A2-009 A-CR-CCP-107/PT-002 DCdts. (1978). *Royal Canadian Army Cadets Course Training Plan Corps Training Program Winter Adventure Training Manual*. Ottawa, ON: The Department of National Defence.

THIS PAGE INTENTIONALLY LEFT BLANK



ROYAL CANADIAN ARMY CADETS
GREEN STAR
INSTRUCTIONAL GUIDE



SECTION 5

EO C123.03 – PARTICIPATE IN A SNOWSHOEING HIKE

Total Time: 270 min

PREPARATION

PRE-LESSON INSTRUCTIONS

Resources needed for the delivery of this lesson are listed in the lesson specification located in A-CR-CCP-701/PG-001, *Green Star Qualification Standard and Plan*, Chapter 4. Specific uses for said resources are identified throughout the instructional guide within the TP for which they are required.

Review the lesson content and become familiar with the material prior to delivering the lesson.

PRE-LESSON ASSIGNMENT

Nil.

APPROACH

An experiential approach was chosen for this lesson as it allows the cadets to acquire new knowledge and skills through a direct experience. The cadets experience snowshoeing and define that experience on a personal level. The cadets will be given the opportunity to reflect on and examine what they saw, felt and thought while participating in snowshoeing and consider how it relates to what they already learned and experienced as well as how it will relate to future experiences.

INTRODUCTION

REVIEW

Nil.

OBJECTIVES

By the end of this lesson, the cadets shall be expected to know the basic principles and techniques for snowshoeing.

IMPORTANCE

Snowshoeing enhances winter camping and hiking by providing a mode of personal transportation to use in the winter. It also provides fun, physically challenging exposure to a new sport.

Teaching Point 1**Discuss snow.**

Time: 15 min

Method: Interactive Lecture

CONDITIONS OF TEMPERATURE

Newly fallen snow undergoes many alterations on the ground. As the snow on the ground becomes denser, snowflakes consolidate and trapped air is expelled. These changes are affected by conditions of temperature that are caused by sunlight and wind.

Sunlight. In the springtime, the sun may melt the surface of the snow even though the air temperature is below freezing. This will usually cause dry, powdery snow in shaded areas, and wetter snow in sunny areas. Low temperatures at night can cause the wet snow to form a crust over the surface during the night.

Wind. Wind can pack and drift snow. The more constant the wind is, the harder the snow will be packed. Activities such as snowshoeing, skiing and walking will make no impression on the surface. Changes in temperature between warm wind, and those below freezing, will cause an ice crust to form. Movement under such conditions can be quite difficult. Loose snow will drift in the wind causing a wavy surface.

MAIN CHARACTERISTICS OF SNOW

There are three main characteristics of snow that are of interest:

Carrying Capacity. The harder the snow is packed, the greater the amount of weight it will be able to support. An ice crust may have a good carrying capacity, but be difficult to move across because it is too slippery.

Sliding Characteristics. Generally dry snow, packed snow and crusted snow provide better sliding characteristics than wet snow, falling snow and newly fallen snow.

Holding Capacity. This is of interest mainly to skiers, not to snowshoers. It is the ability of the snow to hold the ski and prevent it from sliding backward.

CATEGORIES OF SNOW

Wet Snow. Wet snow is most common in springtime, but can be found in autumn or late winter. It can be made into a solid snowball.

Moist Snow. Moist snow is usually found in early winter, but may occur later in the winter during warm periods. It can be made into a snowball, but has a tendency to fall apart.

Dry Snow. Generally found in mid-winter but can occur at any time when the temperatures are low. It may be packed from the wind, or powdered. At very low temperatures, this snow is more like sand, and has poor qualities for sliding.

New Snow. It may be wet, moist or dry depending on the conditions in which it falls.

CONFIRMATION OF TEACHING POINT 1

QUESTIONS

- Q1. What are two factors that contribute to the effect on temperature?
- Q2. What is carrying capacity?
- Q3. What are the four categories of snow?

ANTICIPATED ANSWERS

- A1. Sunlight and wind.
- A2. Carrying capacity means that the harder the snow is packed, the more weight it can endure.
- A3. Wet, moist, dry, and new.

Teaching Point 2

Describe snowshoe components.

Time: 10 min

Method: Interactive Lecture



The instructor is to use the actual snowshoe being utilized during the activity portion of the period as the model for identifying parts.

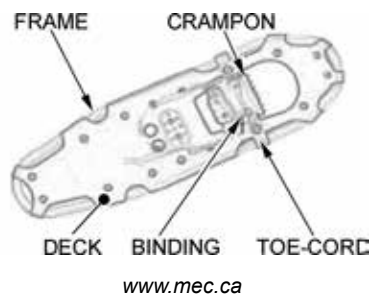

Figure 1 Parts of the Snowshoe

FRAMES

The frame is the skeleton. It usually, but not always, includes both an outside framework and crosspieces that provide stability within. Most snowshoes have either a traditional steamed and bent wood frame, or an aluminum alloy frame that is welded or riveted together.

Wood Frame. Wood frames must be made from wood that has straight grain and no knots or other flaws that may weaken it. Common woods for snowshoes are white ash, sugar maple or yellow birch.

Aluminum Frame. Some aluminum alloy frames are anodized with an electrostatic coating that protects the aluminum from corrosion. Others are painted using an etching preparation to prevent chipping. Some snowshoes, particularly military-issue snowshoes, are made with frames made of high-strength, aircraft-grade magnesium alloy.

Plastic Frame. Some interjected snowshoes have a frame and deck that are constructed to be one solid piece of plastic.

DECKING

Decking (or lacing), is also known as the carrying surface, is the surface that effectively makes our feet bigger. It may be webbed, as are traditional rawhide-laced snowshoes, or it may be solid or nearly solid, as are many new design snowshoes with neoprene or other synthetic decks. These new style decks give better flotation using a solid decking than those with more traditional webbing. As a result, a smaller snowshoe can be worn if it is decked.

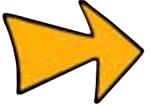

Neoprene is a rubber-like material. It is the same material used to make wet suits.

BINDINGS

The binding attaches the foot to the snowshoe. Bindings come in a bewildering array of styles, from an impromptu harness fashioned of cord, to a snap-in binding similar to those used for cross-country skis or snowboards, designed so the wearer can switch from one to another in a matter of seconds. Between those two extremes are the A-type and the H-type bindings, named for the approximate shapes their straps form. The binding may also have a crampon, or metal cleat, used to dig in on icy routes.



The instructor is to concentrate on the type of snowshoe and binding being used by the cadets on the FTX; however, the other designs are worthy of mention, in the event the cadets encounter them on future training.

CONFIRMATION OF TEACHING POINT 2

QUESTIONS

- Q1. What are the three types of frames?
- Q2. What is the decking?
- Q3. What does the binding attach the foot to?

ANTICIPATED ANSWERS

- A1. Wood, aluminum and plastic.
- A2. Decking is known as the carrying surface. It effectively makes the foot bigger.
- A3. The binding attaches the foot to the snowshoe.

Teaching Point 3

Explain and demonstrate snowshoeing techniques.

Time: 85 min

Method: Demonstration and Performance



The instructor shall provide an EXPLANATION and DEMONSTRATION of the complete skill.

The instructor shall also provide an EXPLANATION and DEMONSTRATION of each step required to effectively complete the skill.

WALKING

Simply place one foot in front of the other, sliding it if the binding provides free rotation, stepping if fixed. Make sure one snowshoe does not land on the other, or you will tumble. If you fall, roll your weight back on to the snowshoes while tucked, and then rise. Once you are able to walk, try finding a pace that is comfortable for you.

BACKING UP

Backing up is a little more difficult. The easiest way to reverse direction is to make a sweeping U-turn, but it is not often possible. While stepping in reverse, it helps to watch your feet. Fixed-rotation snowshoes and free-rotation snowshoes without tails make it easier to move backward.

EDGING

To move across a hillside, kick the uphill edge of the snowshoe into the hillside, to create a horizontal step. Poles will help you balance as you move.

TRAVERSING

Traversing is probably the most practical climb and descent manoeuvre. In this switchback edging technique, you move diagonally back and forth across a hill, creating a zigzag track up or down the hill.

DOWNHILL

Going downhill can be one of the most difficult snowshoe manoeuvres. The snowshoe will tend to slide. When going downhill a snowshoe with heel traction is useful. Keep your knees bent, leaning back slightly to place as much weight as possible on the heels, providing additional traction. No matter where you are walking, try not to walk too close to rocks, trees, or shrubs, especially if they are partially covered with snow. The wind may have left snow less pockets near these objects into which you might drop.

USING POLES

Poles can be a great aid in helping you balance on top of your snowshoes. You can also push against poles for some forward momentum, taking some of the weight off your legs and giving more of the work to your upper body and arms. Poles can also be used to prod the snow in search of avalanche victims.



Cadets will IMITATE the demonstration provided by the instructor for each step within the skill. The instructor(s) will SUPERVISE the cadets during this imitation.

CONFIRMATION OF TEACHING POINT 3

QUESTIONS

- Q1. What do you do when you fall?
- Q2. What should you try to avoid when walking on snowshoes?
- Q3. When using poles, which part of the body will get more of a workout?

ANTICIPATED ANSWERS

- A1. Roll your weight onto your snowshoes and then rise.
- A2. You should avoid walking near rocks, trees and shrubs.
- A3. The upper body and arms will get more of a workout if you are using your poles.

END OF LESSON CONFIRMATION

Once cadets have had suitable time for practice, they should participate in a winter hike for the remainder of the time allocated to this lesson.

CONCLUSION

HOMEWORK/READING/PRACTICE

Cadets should practice snowshoeing techniques until they are more comfortable with the various techniques and manoeuvres.

METHOD OF EVALUATION

Nil.

CLOSING STATEMENT

Snowshoeing can be a fun activity during a winter FTX. It allows cadets to remain active and they will learn a new hiking skill.

INSTRUCTOR NOTES/REMARKS

This lesson is best delivered under the supervision of a cold weather instructor.

EO C123.02 (Explain Snowshoe March Discipline) shall be conducted prior to this lesson.

The route chosen for the march should cover different types of terrain, allowing the cadets a full snowshoeing experience, and simulating most conditions found in the field.

REFERENCES

A2-009 A-CR-CCP-107/PT-002 D Cds. (1978). *Royal Canadian Army Cadets Course Training Plan Corps Training Program Winter Adventure Training Manual*. Ottawa, ON: The Department of National Defence.

C2-013 (ISBN 0-8117-2928-1) Griffin, S.A. (1998). *Snowshoeing*. Mechanicsburg, PA: Stackpole Books.