



ROYAL CANADIAN ARMY CADETS

RED STAR – INSTRUCTIONAL GUIDES

(ENGLISH)

(Supersedes A-CR-CCP-702/PF-001 dated 2007-06-18)

Cette publication est disponible en français sous le numéro A-CR-CCP-702/PF-002.

Issued on Authority of the Chief of the Defence Staff

Canada



NOTICE

This documentation has been reviewed by the technical authority and does not contain controlled goods. Disclosure notices and handling instructions originally received with the document shall continue to apply.

AVIS

Cette documentation a été révisée par l'autorité technique et ne contient pas de marchandises contrôlées. Les avis de divulgation et les instructions de manutention reçues originalement doivent continuer de s'appliquer.



ROYAL CANADIAN ARMY CADETS

RED STAR – INSTRUCTIONAL GUIDES

(ENGLISH)

(Supersedes A-CR-CCP-702/PF-001 dated 2007-06-18)

Cette publication est disponible en français sous le numéro A-CR-CCP-702/PF-002.

Issued on Authority of the Chief of the Defence Staff

OPI: D Cdts & JCR 4 – Cdts & JCR Training

2015-09-01

Canada



NOTICE

This documentation has been reviewed by the technical authority and does not contain controlled goods. Disclosure notices and handling instructions originally received with the document shall continue to apply.

AVIS

Cette documentation a été révisée par l'autorité technique et ne contient pas de marchandises contrôlées. Les avis de divulgation et les instructions de manutention reçues originalement doivent continuer de s'appliquer.

LIST OF EFFECTIVE PAGES

Insert latest changed pages and dispose of superseded pages in accordance with applicable orders.

NOTE

The portion of the text affected by the latest change is indicated by a black vertical line in the margin of the page. Changes to illustrations are indicated by miniature pointing hands or black vertical lines.

Dates of issue for original and changed pages are:

Original.....	0	2015-09-01	Ch.....	3
Ch.....	1		Ch.....	4
Ch.....	2		Ch.....	5

Zero in Change No. column indicates an original page. Total number of pages in this publication is 729 consisting of the following:

Page No.	Change No.	Page No.	Change No.
Cover page.....	0	C203.06-1 to C203.06-6.....	0
Title.....	0	X04-1 to X04-2.....	0
A to C.....	0	X05-1 to X05-2.....	0
i to viii.....	0	M206.01-1 to M206.01-6.....	0
X01-1 to X01-2.....	0	M206.01A-1 to M206.01A-2.....	0
X02-1 to X02-2.....	0	M206.01B-1 to M206.01B-2.....	0
M203.01-1 to M203.01-6.....	0	M206.01C-1 to M206.01C-2.....	0
M203.01A-1 to M203.01A-2.....	0	M206.01D-1 to M206.01D-2.....	0
M203.02-1 to M203.02-8.....	0	M206.01E-1 to M206.01E-2.....	0
M203.03-1 to M203.03-8.....	0	M206.01F-1 to M206.01F-2.....	0
M203.04-1 to M203.04-8.....	0	M206.01G-1 to M206.01G-2.....	0
M203.05-1 to M203.05-8.....	0	M206.01H-1 to M206.01H-2.....	0
M203.05A-1 to M203.05A-2.....	0	M206.01I-1 to M206.01I-2.....	0
M203.05B-1 to M203.05B-2.....	0	M206.01J-1 to M206.01J-2.....	0
M203.05C-1 to M203.05C-2.....	0	C206.01-1 to C206.01-8.....	0
M203.06-1 to M203.06-6.....	0	C206.02-1 to C206.02-10.....	0
M203.06A-1 to M203.06A-2.....	0	C206.03-1 to C206.03-6.....	0
M203.07-1 to M203.07-6.....	0	M207.01-1 to M207.01-8.....	0
M203.08-1 to M203.08-4.....	0	M207.01A-1 to M207.01A-2.....	0
C203.01-1 to C203.01-4.....	0	M207.01B-1 to M207.01B-6.....	0
C203.01A-1 to C203.01A-4.....	0	M207.02-1 to M207.02-14.....	0
C203.02-1 to C203.02-6.....	0	M207.02A-1 to M207.02A-2.....	0
C203.02A-1 to C203.02A-2.....	0	M207.03-1 to M207.03-6.....	0
C203.03-1 to C203.03-6.....	0	M207.04-1 to M207.04-6.....	0
C203.03A-1 to C203.03A-2.....	0	C207.01-1 to C207.01-8.....	0
C203.04-1 to C203.04-2.....	0	C207.01A-1 to C207.01A-2.....	0
C203.05-1 to C203.05-6.....	0	C207.01B-1 to C207.01B-4.....	0

LIST OF EFFECTIVE PAGES (Cont)

Page No.	Change No.	Page No.	Change No.
C207.01C-1 to C207.01C-2.....	0	C221.02B-1 to C221.02B-6.....	0
C207.01D-1 to C207.01D-4.....	0	C221.03-1 to C221.03-20.....	0
C207.02-1 to C207.02-2.....	0	C221.03A-1 to C221.03A-2.....	0
M208.01-1 to M208.01-6.....	0	C221.03B-1 to C221.03B-6.....	0
M208.02-1 to M208.02-6.....	0	M222.01-1 to M222.01-8.....	0
C208.01-1 to C208.01-2.....	0	M222.01A-1 to M222.01A-2.....	0
C208.02-1 to C208.02-2.....	0	M222.01B-1 to M222.01B-2.....	0
C211.01-1 to C211.01-6.....	0	M222.02-1 to M222.02-8.....	0
C211.02-1 to C211.02-8.....	0	M222.02A-1 to M222.02A-2.....	0
C211.02A-1 to C211.02A-6.....	0	M222.03-1 to M222.03-8.....	0
C211.02B-1 to C211.02B-2.....	0	M222.03A-1 to M222.03A-2.....	0
C211.03-1 to C211.03-10.....	0	M222.04-1 to M222.04-8.....	0
C211.03A-1 to C211.03A-6.....	0	M222.05-1 to M222.05-4.....	0
C211.04-1 to C211.04-10.....	0	M222.06-1 to M222.06-8.....	0
C211.04A-1 to C211.04A-4.....	0	C222.01-1 to C222.01-8.....	0
C211.04B-1 to C211.04B-4.....	0	C222.01A-1 to C222.01A-2.....	0
C211.04C-1 to C211.04C-6.....	0	M223.01-1 to M223.01-16.....	0
C211.04D-1 to C211.04D-2.....	0	M223.01A-1 to M223.01A-6.....	0
C211.04E-1 to C211.04E-2.....	0	M223.01B-1 to M223.01B-4.....	0
X20-1 to X20-2.....	0	M223.01C-1 to M223.01C-2.....	0
M221.01-1 to M221.01-10.....	0	M223.01D-1 to M223.01D-8.....	0
M221.02-1 to M221.02-18.....	0	M223.02-1 to M223.02-14.....	0
M221.03-1 to M221.03-8.....	0	M223.03-1 to M223.03-16.....	0
M221.03A-1 to M221.03A-16.....	0	M224.01-1 to M224.01-8.....	0
M221.03B-1 to M221.03B-2.....	0	M224.01A-1 to M224.01A-2.....	0
M221.04-1 to M221.04-10.....	0	M224.02-1 to M224.02-6.....	0
M221.05-1 to M221.05-10.....	0	M224.02A-1 to M224.02A-2.....	0
M221.05A-1 to M221.05A-4.....	0	M224.02B-1 to M224.02B-2.....	0
M221.06-1 to M221.06-10.....	0	M224.03-1 to M224.03-14.....	0
M221.07-1 to M221.07-20.....	0	M224.04-1 to M224.04-10.....	0
M221.08-1 to M221.08-6.....	0	M224.05-1 to M224.05-14.....	0
M221.09-1 to M221.09-20.....	0	M224.06-1 to M224.06-8.....	0
C221.01-1 to C221.01-10.....	0	C224.01-1 to C224.01-10.....	0
C221.02-1 to C221.02-10.....	0	C224.02-1 to C224.02-10.....	0
C221.02A-1 to C221.02A-4.....	0		

Contact Officer: D Cdts & JCR 4-7-3 – Staff Officer Army Cadet Program Development

© 2015 DND/MDN Canada

THIS PAGE INTENTIONALLY LEFT BLANK

FOREWORD AND PREFACE

1. **Issuing Authority.** This Instructional Guide (IG) A-CR-CCP-702/PF-001 was developed under the authority of the Director Cadets and Junior Canadian Rangers, and issued on the authority of the Chief of Defence Staff.
2. **Development.** Development of this IG was in accordance with the performance oriented concept of training outlined in the A-P9-050 Series, Canadian Forces Individual Training and Education System, with modifications to meet the needs of the Canadian Cadet Organization.
3. **Purpose of the IG.** The IG to be used by Royal Canadian Army Cadet Corps in conjunction with other resources to conduct the Red Star Program. The IG provides instructors with the base means from which to deliver training. Individual IGs are to be reviewed in conjunction with the Lesson Specifications (LSs) found in Chapter 4 of A-CR-CCP-702/PG-001, *Royal Canadian Army Cadet Red Star Qualification Standard and Plan*, before instructing, so that each instructor can adequately plan for and prepare each lesson. Instructors may be required to develop instructional materials to support training in addition to any that may be provided, e.g. posters, videos, handouts, models, etc., supplemental to training control and support documents. Suggested instructional activities are included in most IGs to maximize learning and fun. Instructors are also encouraged to modify and/or enhance the activities, as long as they continue to contribute to enabling objectivity achievement.
4. **Use of the IG.** Throughout these instructional guides, a series of information boxes are used to highlight information; they include:



Note to the Instructor.



Key information to pass along to cadets.



Refer to the following CF regulations and policies.



Points of interest or special instructions the instructor should pass along to cadets.

5. **Suggested Changes.** Suggested changes to this document may be sent directly to cadettraining@canada.ca.

THIS PAGE INTENTIONALLY LEFT BLANK

TABLE OF CONTENTS

		PAGE
CHAPTER 1	PO X01 – PARTICIPATE IN CITIZENSHIP ACTIVITIES	
	PO X01 – PARTICIPATE IN CITIZENSHIP ACTIVITIES.....	X01-1
CHAPTER 2	PO X02 – PERFORM COMMUNITY SERVICE	
	PO X02 – PERFORM COMMUNITY SERVICE.....	X02-1
CHAPTER 3	PO 203 – DEMONSTRATE LEADERSHIP ATTRIBUTES WITHIN A PEER SETTING	
Section 1	EO M203.01 – DISCUSS LEADERSHIP WITHIN A PEER SETTING.	M203.01-1
Annex A	GOAL MAPPING EXERCISE	M203.01A-1
Section 2	EO M203.02 – DISCUSS THE PRINCIPLES OF LEADERSHIP.....	M203.02-1
Section 3	EO M203.03 – DISCUSS EFFECTIVE COMMUNICATION IN A PEER SETTING.....	M203.03-1
Section 4	EO M203.04 – DEMONSTRATE POSITIVE GROUP DYNAMICS.....	M203.04-1
Section 5	EO M203.05 – DISCUSS INFLUENCE BEHAVIOURS	M203.05-1
Annex A	SKIT FOR DIRECTIVE BEHAVIOUR	M203.05A-1
Annex B	SKIT FOR THE PERSUASIVE BEHAVIOUR	M203.05B-1
Annex C	SKIT FOR THE PARTICIPATIVE BEHAVIOUR	M203.05C-1
Section 6	EO M203.06 – EMPLOY PROBLEM SOLVING.....	M203.06-1
Annex A	PROBLEM SOLVING SCENARIO	M203.06A-1
Section 7	EO M203.07 – DISCUSS PERSONAL INTEGRITY AS A QUALITY OF LEADERSHIP	M203.07-1
Section 8	EO M203.08 – PARTICIPATE IN TEAM-BUILDING ACTIVITIES.....	M203.08-1
Section 9	EO C203.01 – RECORD ENTRIES IN A REFLECTIVE JOURNAL.....	C203.01-1
Annex A	TEMPLATES	C203.01A-1
Section 10	EO C203.02 – EMPLOY PROBLEM SOLVING.....	C203.02-1
Annex A	SCENARIOS	C203.02A-1
Section 11	EO C203.03 – DISCUSS CHARACTERISTICS OF A LEADER.....	C203.03-1
Annex A	INFORMATION TO RESEARCH	C203.03A-1
Section 12	EO C203.04 – PARTICIPATE IN A PRESENTATION GIVEN BY A LEADER.....	C203.04-1
Section 13	EO C203.05 – PARTICIPATE IN TRUST-BUILDING ACTIVITIES.....	C203.05-1
Section 14	EO C203.06 – PARTICIPATE IN PROBLEM-SOLVING ACTIVITIES.	C203.06-1
CHAPTER 4	PO X04 – TRACK PARTICIPATION IN PHYSICAL ACTIVITIES	
	PO X04 – TRACK PARTICIPATION IN PHYSICAL ACTIVITIES.....	X04-1
CHAPTER 5	PO X05 – PARTICIPATE IN PHYSICAL ACTIVITIES	
	PO X05 – PARTICIPATE IN PHYSICAL ACTIVITIES.....	X05-1

TABLE OF CONTENTS (Cont)

		PAGE
CHAPTER 6	PO 206 – FIRE THE CADET AIR RIFLE DURING RECREATIONAL MARKSMANSHIP	
Section 1	EO M206.01 – PARTICIPATE IN A RECREATIONAL MARKSMANSHIP ACTIVITY.....	M206.01-1
Annex A	CLASSIFICATION ACTIVITY	M206.01A-1
Annex B	FUN ACTIVITY	M206.01B-1
Annex C	FUN ACTIVITY	M206.01C-1
Annex D	FUN ACTIVITY	M206.01D-1
Annex E	FUN ACTIVITY	M206.01E-1
Annex F	TIMED ACTIVITY	M206.01F-1
Annex G	TIMED ACTIVITY	M206.01G-1
Annex H	TIMED ACTIVITY	M206.01H-1
Annex I	COMPETITIVE ACTIVITY	M206.01I-1
Annex J	COMPETITIVE ACTIVITY	M206.01J-1
Section 2	EO C206.01 – PRACTICE HOLDING TECHNIQUES.....	C206.01-1
Section 3	EO C206.02 – PRACTICE AIMING TECHNIQUES.....	C206.02-1
Section 4	EO C206.03 – PRACTICE FIRING TECHNIQUES.....	C206.03-1
CHAPTER 7	PO 207 – SERVE IN AN ARMY CADET CORPS	
Section 1	EO M207.01 – IDENTIFY RED STAR TRAINING OPPORTUNITIES. ACTIVITY	M207.01-1
Annex A	ACTIVITY	M207.01A-1
Annex B	EXAMPLES OF FULL VALUE CONTRACTS	M207.01B-1
Section 2	EO M207.02 – RECOGNIZE THE HISTORY OF THE ROYAL CANADIAN ARMY CADETS (RCAC).....	M207.02-1
Annex A	SUMMARY OF SIGNIFICANT EVENTS	M207.02A-1
Section 3	EO M207.03 – RECOGNIZE THE ROLE AND RESPONSIBILITIES OF THE LOCAL SPONSOR.....	M207.03-1
Section 4	EO M207.04 – IDENTIFY YEAR TWO CSTC TRAINING OPPORTUNITIES.....	M207.04-1
Section 5	EO C207.01 – IDENTIFY THE RANK STRUCTURE OF THE ROYAL CANADIAN SEA AND AIR CADETS.....	C207.01-1
Annex A	CADET RANKS	C207.01A-1
Annex B	INSIGNIA	C207.01B-1
Annex C	ACTIONS	C207.01C-1
Annex D	MEMORY MATCH CARDS	C207.01D-1
Section 6	EO C207.02 – VISIT A LOCAL CADET CORPS OR SQUADRON.....	C207.02-1
CHAPTER 8	PO 208 – EXECUTE DRILL AS A MEMBER OF A SQUAD	
Section 1	EO M208.01 – EXECUTE LEFT AND RIGHT TURNS ON THE MARCH.....	M208.01-1

TABLE OF CONTENTS (Cont)

		PAGE
Section 2	EO M208.02 – FORM SINGLE FILE FROM THE HALT.....	M208.02-1
Section 3	EO C208.01 – PRACTICE CEREMONIAL DRILL AS A REVIEW.....	C208.01-1
Section 4	EO C208.02 – EXECUTE DRILL WITH ARMS.....	C208.02-1
CHAPTER 9	PO 211 – PARTICIPATE IN COMPETITIVE SUMMER BIATHLON ACTIVITIES	
Section 1	EO C211.01 – IDENTIFY CIVILIAN BIATHLON OPPORTUNITIES....	C211.01-1
Section 2	EO C211.02 – RUN ON ALTERNATING TERRAIN.....	C211.02-1
Annex A	SAMPLE STRETCHES	C211.02A-1
Annex B	TEN WEEK RUNNING SCHEDULE	C211.02B-1
Section 3	EO C211.03 – FIRE THE CADET AIR RIFLE USING A SLING FOLLOWING PHYSICAL ACTIVITY.....	C211.03-1
Annex A	SAMPLE STRETCHES	C211.03A-1
Section 4	EO C211.04 – PARTICIPATE IN A COMPETITIVE SUMMER BIATHLON ACTIVITY.....	C211.04-1
Annex A	GUIDELINES FOR CONDUCTING A COMPETITIVE SUMMER BIATHLON ACTIVITY	C211.04A-1
Annex B	COMPETITION GUIDELINES	C211.04B-1
Annex C	SAMPLE STRETCHES	C211.04C-1
Annex D	INVITATION SAMPLE	C211.04D-1
Annex E	AWARDS INSTRUCTIONS	C211.04E-1
CHAPTER 10	PO X20 – PARTICIPATE IN CAF FAMILIARIZATION	
	PO X20 – PARTICIPATE IN CAF FAMILIARIZATION.....	X20-1
CHAPTER 11	PO 221 – PERFORM THE DUTIES OF A SECTION MEMBER DURING A WEEKEND BIVOUAC EXERCISE	
Section 1	EO M221.01 – PERFORM THE DUTIES OF A SECTION MEMBER IN THE FIELD.....	M221.01-1
Section 2	EO M221.02 – IDENTIFY SECTION EQUIPMENT.....	M221.02-1
Section 3	EO M221.03 – IDENTIFY PROVINCIAL/TERRITORIAL WILDLIFE....	M221.03-1
Annex A	PROVINCIAL/TERRITORIAL WILDLIFE	M221.03A-1
Annex B	PROVINCIAL/TERRITORIAL WILDLIFE WORKSHEET.....	M221.03B-1
Section 4	EO M221.04 – PERFORM BASIC FIRST AID.....	M221.04-1
Section 5	EO M221.05 – TIE KNOTS.....	M221.05-1
Annex A	KNOT-TYING INSTRUCTIONS	M221.05A-1
Section 6	EO M221.06 – CONSTRUCT A HOOCHIE SHELTER.....	M221.06-1
Section 7	EO M221.07 – USE SECTION EQUIPMENT.....	M221.07-1
Section 8	EO M221.08 – PREPARE AN INDIVIDUAL MEAL PACKAGE (IMP)..	M221.08-1
Section 9	EO M221.09 – MAINTAIN SECTION EQUIPMENT FOLLOWING A FIELD TRAINING EXERCISE (FTX).....	M221.09-1

TABLE OF CONTENTS (Cont)

		PAGE
Section 10	EO C221.01 – PARTICIPATE IN A DISCUSSION ON CANADA’S WILDERNESS CONSERVATION EFFORTS.....	C221.01-1
Section 11	EO C221.02 – CONSTRUCT FIELD AMENITIES.....	C221.02-1
Annex A	TYING LASHINGS	C221.02A-1
Annex B	FIELD AMENITIES	C221.02B-1
Section 12	EO C221.03 – IDENTIFY SPECIES OF TREES.....	C221.03-1
Annex A	ANSWER SHEET	C221.03A-1
Annex B	PICTURES OF TREES	C221.03B-1
CHAPTER 12	PO 222 – NAVIGATE ALONG A ROUTE USING A MAP AND COMPASS	
Section 1	EO M222.01 – REVIEW GREEN STAR NAVIGATION.....	M222.01-1
Annex A	MAP FOLDING ACTIVITY SHEET	M222.01A-1
Annex B	LAND FEATURES	M222.01B-1
Section 2	EO M222.02 – DESCRIBE BEARINGS.....	M222.02-1
Annex A	COMPASS ROSE ACTIVITY SHEET	M222.02A-1
Section 3	EO M222.03 – IDENTIFY COMPASS PARTS.....	M222.03-1
Annex A	COMPASS PARTS	M222.03A-1
Section 4	EO M222.04 – DETERMINE DISTANCE ALONG A ROUTE.....	M222.04-1
Section 5	EO M222.05 – ORIENT A MAP USING A COMPASS.....	M222.05-1
Section 6	EO M222.06 – FOLLOW A MAGNETIC BEARING POINT TO POINT	M222.06-1
Section 7	EO C222.01 – PRACTICE NAVIGATION USING A MAP AND COMPASS.....	C222.01-1
Annex A	PUZZLE NAVIGATION	C222.01A-1
CHAPTER 13	PO 223 – HIKE ALONG A ROUTE AS PART OF AN OVERNIGHT EXERCISE	
Section 1	EO M223.01 – PREPARE FOR TREKKING.....	M223.01-1
Annex A	TREKKING GEAR CARDS	M223.01A-1
Annex B	WEATHER FORECAST SCENARIOS	M223.01B-1
Annex C	WEATHER FORECAST SCENARIOS – ANSWER KEY	M223.01C-1
Annex D	STRETCHES AND EXERCISES	M223.01D-1
Section 2	EO M223.02 – IDENTIFY HIKING/TREKKING ASSOCIATIONS.....	M223.02-1
Section 3	EO M223.03 – PARTICIPATE IN A DISCUSSION ON CROSSING OBSTACLES WHILE TREKKING.....	M223.03-1
CHAPTER 14	PO 224 – IDENTIFY IMMEDIATE ACTIONS TO TAKE WHEN LOST	
Section 1	EO M224.01 – DESCRIBE IMMEDIATE ACTIONS TO TAKE WHEN LOST.....	M224.01-1
Annex A	CADENCE ARTICLE	M224.01A-1

TABLE OF CONTENTS (Cont)

		PAGE
Section 2	EO M224.02 – IDENTIFY THE SEVEN ENEMIES OF SURVIVAL.....	M224.02-1
Annex A	ENEMIES OF SURVIVAL PUZZLE	M224.02A-1
Annex B	ENEMIES OF SURVIVAL PUZZLE – ANSWER KEY	M224.02B-1
Section 3	EO M224.03 – PREDICT WEATHER USING CLOUD FORMATIONS	M224.03-1
Section 4	EO M224.04 – IDENTIFY EMERGENCY SHELTERS.....	M224.04-1
Section 5	EO M224.05 – PREPARE, LIGHT, MAINTAIN, AND EXTINGUISH A FIRE.....	M224.05-1
Section 6	EO M224.06 – IDENTIFY METHODS OF SIGNALLING.....	M224.06-1
Section 7	EO C224.01 – COOK IN THE FIELD.....	C224.01-1
Section 8	EO C224.02 – PREPARE A SIGNAL FIRE.....	C224.02-1

THIS PAGE INTENTIONALLY LEFT BLANK



**COMMON TRAINING
ALL TRAINING LEVELS
INSTRUCTIONAL GUIDE
CITIZENSHIP**



SECTION 1

PO X01 – PARTICIPATE IN CITIZENSHIP ACTIVITIES

Total Time:

For the following EOs, refer to the lesson specifications located in A-CR-CCP-701/PG-001, *Royal Canadian Army Cadets Green Star Qualification Standard and Plan*:

- MX01.01A – Participate in a Citizenship Tour,
- MX01.01B – Attend a Presentation by a Community Organization,
- MX01.01C – Attend a Presentation by a Citizen-of-Interest,
- MX01.01D – Participate in the Canadian Citizenship Challenge,
- MX01.01E – Host a Citizenship Ceremony, and
- CX01.01 – Participate in Citizenship Activities.

For the following EOs, refer to the instructional guides located in A-CR-CCP-701/PF-001, *Royal Canadian Army Cadets Green Star Instructional Guides*:

- MX01.01F – Participate in an Election,
- MX01.01G – Participate in Heritage Minutes Video Activities, and
- MX01.01H – Participate in Citizenship Learning Stations.

THIS PAGE INTENTIONALLY LEFT BLANK



**COMMON TRAINING
ALL TRAINING LEVELS
INSTRUCTIONAL GUIDE
COMMUNITY SERVICE**



SECTION 1

PO X02 – PERFORM COMMUNITY SERVICE

Total Time:

For the following EOs, refer to the instructional guides located in A-CR-CCP-701/PF-001, *Royal Canadian Army Cadets Green Star Instructional Guides*:

- MX02.01 – Perform Community Service, and
- CX02.01 – Perform Community Service.

THIS PAGE INTENTIONALLY LEFT BLANK



COMMON TRAINING INSTRUCTIONAL GUIDE



SECTION 1

EO M203.01 – DISCUSS LEADERSHIP WITHIN A PEER SETTING

Total Time:

30 min

PREPARATION

PRE-LESSON INSTRUCTIONS

Resources needed for the delivery of this lesson are listed in the lesson specification located in A-CR-CCP-702/PG-001, Chapter 4. Specific uses for said resources are identified throughout the Instructional Guide within the TP for which they are required.

Review the lesson content and become familiar with the material prior to delivering the lesson.

The list of responsibilities of Red Star cadets will vary for each corps. Information about the specific responsibilities should be available in the corps Standing Orders or by speaking to the corps Commanding Officer/Training Officer.

Photocopy the handout at Annex A, one for each cadet.

PRE-LESSON ASSIGNMENT

N/A.

APPROACH

An interactive lecture was chosen for TP1 to orient the cadets to leadership within a peer setting, to generate interest and to present basic material.

An in-class activity was chosen for TP2 as an interactive way to provoke thought, stimulate an interest among cadets and present leadership within a peer setting.

INTRODUCTION

REVIEW

N/A.

OBJECTIVES

By the end of this lesson the cadet shall be expected to discuss leadership within a peer setting.

IMPORTANCE

It is important for cadets to learn about leadership within a peer setting because there are responsibilities for second year cadets. Being aware of the responsibilities second year cadets perform will assist them in setting achievable goals and adapting to their new role as leaders in the corps.

Teaching Point 1

Explain Leadership Within a Peer Setting

Time: 15 min

Method: Interactive Lecture

Within junior leadership, there are responsibilities for a Red Star cadet at the corps. To make the second year of cadets a fun, challenging and dynamic experience, second year cadets should know their responsibilities.



Have cadets brainstorm a list of what they think the responsibilities of a Red Star cadet are. As you teach each of the following points, try to match them to the cadet generated list.

There are some responsibilities common to every Red Star cadet in the corps. They are:

- **Following the Chain of Command.** Following the chain of command ensures that all information that must be passed up and down the chain is delivered. Following the chain of command prevents gaps in the information flow.
- **Setting the Example.** A Red Star cadet must set a personal example in dress and deportment. A good leader will never ask more of their followers and teammates than they are willing to give themselves.
- **Being Firm, Fair and Friendly with Everyone, Especially New Recruits.** No one is impressed with a Red Star cadet who yells, least of all new cadets. A highly influential and respected Red Star cadet is one who is consistent in their approach to people and each situation. Being approachable at all times should enable the cadet to fulfill all duties and responsibilities in an effective manner.
- **Being Respectful to Superiors and Subordinates.** Using a proper tone of voice, looking people in the eyes when they speak and standing up straight is a physical way to show respect. If the Red Star cadet wishes to be treated with respect, they must display respect toward others.
- **Being Aware of Safety Hazards.**
- **Displaying Initiative.** Undertaking small matters, like cleaning up, before being told to do so is an example of using initiative. Superiors notice when small tasks are completed without any request to do so.
- **Setting Goals.** Every leader needs to set goals. Goals allow people the opportunity to turn ideas into results. A goal is a glimpse of the future. Setting goals like improving their drill, dress and deportment, gives Red Star cadets something to strive for. By setting goals, and working towards them, a Red Star cadet will show commitment.



If the corps has no specific duties for Red Star cadets, do not teach the following point.

There are specific responsibilities of a Red Star cadet in this corps.



Explain the corps specific Red Star cadet responsibilities.

CONFIRMATION OF TEACHING POINT 1

QUESTIONS

- Q1. List the responsibilities of Red Star cadets in the corps.
- Q2. Why is setting goals important for a Red Star cadet?
- Q3. List the specific Red Star cadet duties and responsibilities for your corps.

ANTICIPATED ANSWERS

- A1. The responsibilities of every Red Star cadet in the corps are:
- following the chain of command;
 - setting the example;
 - being firm, fair and friendly with everyone, especially new recruits;
 - being respectful towards your superiors and subordinates;
 - being aware of safety hazards;
 - displaying initiative; and
 - setting goals.
- A2. By setting goals and working towards them, the Red Star cadet will show commitment.
- A3. Answers will vary.

Teaching Point 2

Conduct a Goal Mapping Activity

Time: 10 min

Method: In-Class Activity

ACTIVITY

OBJECTIVE

The objective of this activity is to have cadets map out personal short-term goals achievable at the corps and personal long-term goals for the training year.

RESOURCES

- Flip chart paper,
- Markers, and
- Goal mapping template located at Annex A.

ACTIVITY LAYOUT

Divide the class into groups of no more than six cadets.

ACTIVITY INSTRUCTIONS

For this in-class activity, short-term goals are goals that can be achieved within three months, and long-term goals are goals that can be achieved by the end of the Red Star Program.

Have cadets, in groups of no more than six, brainstorm, then generate a list on flipchart paper, of personal short-term goals, in order to fulfill their Red Star responsibilities, such as:

- improving their uniform;
- improving their drill; and
- attending all parade nights for the next three months, etc.



Record all the cadet generated short-term goals on a whiteboard/flipchart/OHP so cadets may use the examples.

Have cadets, in groups of no more than six, brainstorm, then generate a list on flipchart paper, of personal long-term goals for the training year, such as:

- getting promoted;
- achieving perfect attendance; and
- attending summer training, etc.



Record all the cadet generated long-term goals on a whiteboard/flipchart/OHP so cadets may use the examples.

Distribute the goal recording sheet located at Annex A. Have the cadets write down two short-term and two long-term personal goals and the steps involved in achieving those goals. These goals may be from the generated list, or they may be completely individual.



After the activity is complete, have the cadets hand in their list of goals. Make a copy to file in each cadet's training file. These lists of goals may be used for periodic interviews by the Red Star Officer to see if cadets met their goals. The list of goals may also be used at the beginning of the next training year to assist cadets in creating goals for Silver Star Program.



Return the original copy of the short-term and long-term goals to the cadet. Encourage cadets to post their personal short-term and long-term goals in a visible place at home, so cadets will be reminded of the goals they have set and whether they are moving towards achieving them.

SAFETY

N/A.

END OF LESSON CONFIRMATION

The cadets' participation in TP1 and TP2 will serve as the confirmation of this lesson.

CONCLUSION

HOMEWORK/READING/PRACTICE

N/A.

METHOD OF EVALUATION

N/A.

CLOSING STATEMENT

In order for a cadet to be successful in the role of a Red Star, they must know their responsibilities. By setting personal short and long term goals, cadets have something to work toward and may be more motivated to complete the tasks ahead.

INSTRUCTOR NOTES/REMARKS

N/A.

REFERENCES

C0-022 (ISBN 0-02864-207-4) Cole, K. (2002). *The Complete Idiot's Guide to Clear Communication*. Indianapolis, IN: Alpha Books.

C0-134 (ISBN 0-7852-7440-5) Maxwell, J. (1999). *The 21 Indispensable Qualities of a Leader: Becoming the Person Others Will Want to Follow*. Nashville, TN: Thomas Nelson Publishers.

THIS PAGE INTENTIONALLY LEFT BLANK

GOAL MAPPING EXERCISE

SHORT-TERM GOALS

Goal No. 1: _____

Steps To Take: _____

Goal No. 2: _____

Steps To Take: _____

LONG-TERM GOALS

Goal No. 1: _____

Steps To Take: _____

Goal No. 2: _____

Steps To Take: _____

THIS PAGE INTENTIONALLY LEFT BLANK



COMMON TRAINING INSTRUCTIONAL GUIDE



SECTION 2

EO M203.02 – DISCUSS THE PRINCIPLES OF LEADERSHIP

Total Time:

30 min

PREPARATION

PRE-LESSON INSTRUCTIONS

Resources needed for the delivery of this lesson are listed in the lesson specification located in A-CR-CCP-702/PG-001, Chapter 4. Specific uses for said resources are identified throughout the Instructional Guide within the TP for which they are required.

Review the lesson content and become familiar with the material prior to delivering the lesson.

PRE-LESSON ASSIGNMENT

N/A.

APPROACH

An interactive lecture was chosen for TP1 and TP2 to orient the cadets to the principles of leadership, to generate interest and to present basic material.

A group discussion was chosen for TP3 as it allows the cadets to interact with their peers and share their knowledge, experiences, opinions and feelings about leaders who display positive influence.

INTRODUCTION

REVIEW

N/A.

OBJECTIVES

By the end of this lesson the cadet shall be expected to discuss the principles of leadership.

IMPORTANCE

It is important for cadets to learn the principles of leadership because they are fundamentals of leadership theory. As listed in CATO 11-03, *Cadet Program Mandate*, leadership is inherent in the participant outcomes of social competence and it is one of the three aims of the Cadet Program.

Teaching Point 1**Discuss the Principles of Leadership**

Time: 5 min

Method: Interactive Lecture

Leadership is a demonstrable skill. This means it can be displayed and observed. Leadership can be learned and the skills involved can be improved with practice. Within leadership there are set of principles that may be used to improve leadership ability.

PRINCIPLES OF LEADERSHIP**Leadership is influence**

The ability to influence others is fundamental within the leadership process. Everyone influences someone. People are influenced by those around them on a daily basis: friends, family, teachers, newsmakers, athletes, etc. all influence others. In turn, those same people are influenced.

Influence can be positive or negative

There are many people who use their influence in a positive manner and while doing so help their community, their school, their family, and the world around them. There are some people who use their influence in a negative manner and while doing so do not help anyone including themselves.

Leadership can create opportunities in life

Qualities of leadership are learned and practiced, therefore improving your ability to lead may create opportunities in life. Throughout the Cadet Program, cadets may be given many occasions to lead. Success in a leadership role may lead to greater leadership opportunities with bigger challenges, more responsibility, rewards, etc.



Ask cadets what occupations they know of in which leadership skills would be an asset.

CONFIRMATION OF TEACHING POINT 1**QUESTIONS**

- Q1. Why is leadership a demonstrable skill?
- Q2. Name the three principles of leadership discussed during the class.
- Q3. Success in a leadership role may lead to what?

ANTICIPATED ANSWERS

- A1. Leadership can be displayed and observed by you and by others.

- A2. The three principles of leadership discussed are:
- Leadership is influence.
 - Influence can be positive or negative.
 - Leadership can create opportunities in life.
- A3. Success in a leadership role may lead to greater leadership opportunities with bigger challenges, more responsibility, rewards, etc.

Teaching Point 2

Share a Brief Narrative of Youth Who Have Influenced the Environment or their Community

Time: 10 min

Method: Interactive Lecture



Choose one of the following four narratives to read to the class.

SIMON JACKSON

When he was seven, Simon Jackson's parents took him from his home in Vancouver, British Columbia to Yellowstone National Park in the United States. Ever since then he has been fascinated with bears. "I came to realize that humans had an option - we had the power to destroy or preserve these magnificent monarchs of the wilderness," says Simon. He set up a lemonade stand in grade two and raised \$60 to protect grizzly bears. A few years later Simon heard about Kermode bears. "I have followed a dream to ensure wild bears a wild place for generations to come." Simon Jackson is one of the few people to have seen the white Kermode or Spirit bear. If things go his way, Simon won't be the last. Simon is doing all he can to save these rare bears from becoming extinct. Loggers want to take trees from the ancient rainforest where they live. Simon has been trying to save the bears for years now. Simon speaks at schools to spread the word about the bears. He persuaded 700 kids to write letters asking the BC government to keep logging companies out of the bear's habitat. In 1996, the government received more letters about the Kermode bear than any other preservation issue. Simon also started the Spirit Bear Youth Coalition. "Many people ask me why I chose to campaign for the future of the spirit bear rather than other endangered animals such as the panda or the elephant," Simon explains. "As I saw it, the spirit bear was as unique to the world as the panda bear is to China and lived only in my home province. This bear, I thought, deserved our admiration, respect and most of all, our protection. I knew I had to help." Simon works with naturalist Jane Goodall, scientist David Suzuki, Native Leader Chief Leonard George and artist Robert Bateman. All of them are trying to save the last of about 100 Kermode bears which live around the Terrace area of BC and Princess Royal Island. So far, the support from tens of thousands of people from around the world helped to protect 135 000 hectares from loggers. Simon hopes the Spirit Bear Youth Coalition will be able to protect the remaining 125 000 hectares for the Kermode bears. "It is like ripples in a pond. If I can get through to one person, that person will get to another," he says. "That is how issues are won." Time magazine named Simon Hero of the Planet – one of six young people selected from around the world in their Spring 2000 edition.

CRAIG KIELBURGER

Craig Kielburger was born 17 December 1982 in Thornhill, Ontario, and is an accomplished child rights advocate and leadership specialist, an award-winning author and a popular speaker. He is the founder of Free The Children, the world's largest network of children helping children through education, and the co-founder of Leaders Today, the world's top youth leadership training organization. When Craig was 12, he was shocked to

learn about the murder of a child labourer-turned-child rights activist. Eager to take action, he established Free The Children to help free children from poverty, exploitation and powerlessness. The organization began as a small group of classmates and quickly evolved into an international phenomenon. Under Craig's leadership, Free The Children has now changed the lives of more than one million young people around the world. The organization has built more than 450 primary schools, providing daily education to more than 40 000 children. Free The Children's many accomplishments in the areas of education, alternative income, health care, water and sanitation provision and peace building have earned three Nobel Peace Prize nominations and facilitated high profile partnerships with organizations such as the United Nations and Oprah's Angel Network. Convinced of the importance of leadership development in empowering youth, Craig co-founded Leaders Today in 1999. Leaders Today empowers young people through leadership education, providing them with the inspiration and tools to affect positive social change. The organization delivers one-of-a-kind local and international training experiences, reaching more than 350 000 youth every year. Craig has travelled to more than 50 countries, visiting underprivileged children and speaking out in defence of children's rights. An internationally renowned speaker, Craig frequently addresses business groups, government bodies, educators, unions and students. A sought-after speaker, he has shared the podium a number of times with former U.S. president Bill Clinton, as well as with such world renowned leaders as Nelson Mandela, Queen Noor, Archbishop Desmond Tutu and the Dalai Lama. Craig has shown the world that no one is ever too young to make a difference. His work has been featured on The Oprah Winfrey Show, CNN, CBC, BBC, 60 Minutes and profiled in The Economist, Time and People magazines and numerous newspapers.

THE GREENKIDS

GreenKids was established during 1990-1991 school year by the sixth grade students in Lafayette Regional School in rural Franconia, New Hampshire. It started as a part of an integrated subject, Critical Skills L.B.R.P. (Learning By Real Problems). The students knew of an absence of children's environmental projects in New England and they wanted to alleviate the problem of the environment. The first group of students, First Generation GreenKids, brainstormed and came up with a list of goals that they hoped to achieve during the school year. Goals included establishing the group, writing a Book of Issues, For Kids by Kids, having it published, writing quarterly newsletters, promoting recycling and responsible environmental attitudes throughout the area and finally, showing that adults will listen to the opinions of children when their opinions are presented intelligently. These lofty goals might seem impossible for a group of 11 and 12 year olds, but through hard work and empowerment they realized all but one of their goals: that of getting their book published. The First Generation succeeded in producing a quality newsletter, and parts of it were featured in the quarterly newsletter of the New Hampshire Wildlife Federation. They researched, edited, and entered their product into a word processor, developed a group of subscribers, and helped pay for materials. The book was based on environmental issues which they felt were very important. They followed the same processes in publishing the book as they did in creating the newsletter. Their work was high quality. GreenKids also had the opportunity to visit other schools to talk about their experiences and to help start their own activist groups. Letters were written to persons in power to expand recycling. But the year was ending and the completed, illustrated book was not yet published. GreenKids Second Generation decided to make these goals its yearly objective: keep the newsletter going; get the school to recycle; buy trees for all nursery school and Kindergarten through grade 5 students; promote community cleanups; and raise funds to publish the book.

KIDS FOR A CLEAN ENVIRONMENT

In 1989, Melissa Poe, a fourth grader in Nashville, Tennessee, founded a children's environmental club called Kids For A Clean Environment or Kids F.A.C.E. In three years the club had grown from a group of six within her elementary school to a positive, proactive international youth organization with more than 200 000 members. She also wrote for the newsletter she created for her club, which had a worldwide distribution of 2 million. In August 1989, Melissa began an ongoing campaign to encourage children and adults to become involved with the protection of our natural resources. Kids F.A.C.E. started when Melissa wrote a letter to the President of the United States. Dissatisfied with the President's initial response, she decided to take action on her own. In January of 1990, she appeared on NBC's Today show after writing a letter requesting an appearance. In April of 1990, 250 billboards were placed nationwide with her letter to the President. She also began speaking to

encourage children to get involved, and she established chapters of Kids F.A.C.E. In May 1990, she wrote a letter to Wal-Mart Corporation asking for help for her club, and in November 1990, Melissa created her club newsletter: Kids F.A.C.E. Illustrated. In October 1991, she drafted the Children's Forest concepts with another organization and prepared and circulated petitions. In September 1992, she launched Kids F.A.C.E. Save-A-Tree project with tree-planting programs. In January 1993, she created the design for International Kid's Earth Flag and began the campaign to get kids to help make the flag. Kids For A Clean Environment is an international children's environmental organization whose purpose is to sponsor educational, community-wide programs in order to further children's involvement in environmental causes; to present information to children concerning the environment and the detrimental effects of pollution and waste on the environment; and to sponsor membership organizations designed to heighten awareness of hazards to the environment and ways of curbing such hazards.

CONFIRMATION OF TEACHING POINT 2

QUESTIONS

- Q1. How do cadets feel about the person or people in the narrative?
- Q2. Do cadets feel these leaders were using the principles of leadership discussed in TP1?
- Q3. How were these principles used?

ANTICIPATED ANSWERS

- A1. Answers will vary.
- A2. Answers will vary.
- A3. Answers will vary.

Teaching Point 3

Discuss a Peer Leader Who has Influenced the Environment or the Community in a Positive Way

Time: 10 min

Method: Group Discussion

BACKGROUND KNOWLEDGE



The point of the group discussion is to draw the following information from the group using the tips for answering/facilitating discussion and the suggested questions provided.

GROUP DISCUSSION



TIPS FOR ANSWERING/FACILITATING DISCUSSION

- Establish ground rules for discussion, e.g. everyone should listen respectfully; don't interrupt; only one person speaks at a time; no one's ideas should be made fun of; you can disagree with ideas but not with the person; try to understand others as much as you hope they understand you; etc.
- Sit the group in a circle, making sure all cadets can be seen by everyone else.
- Ask questions that will provoke thought; in other words avoid questions with yes or no answers.
- Manage time by ensuring the cadets stay on topic.
- Listen and respond in a way that indicates you have heard and understood the cadet. This can be done by paraphrasing their ideas.
- Give the cadets time to respond to your questions.
- Ensure every cadet has an opportunity to participate. One option is to go around the group and have each cadet answer the question with a short answer. Cadets must also have the option to pass if they wish.
- Additional questions should be prepared ahead of time.

SUGGESTED QUESTIONS

- Q1. Describe what types of things could be considered being a positive influence in their community.
- Q2. Describe a situation where their peers have used their influence to help the environment or to help their community.
- Q3. Describe a situation where they have used their influence to help the environment or to help their community.
- Q4. Describe what types of things youth at their age level could do in their community to be a positive influence.



Other questions and answers will develop throughout the group discussion. The group discussion should not be limited to only those suggested.



Reinforce those answers given and comments made during the group discussion, ensuring the teaching point has been covered.

END OF LESSON CONFIRMATION

The cadets' participation in the group discussion in TP3 will serve as the confirmation of this lesson.

CONCLUSION

HOMEWORK/READING/PRACTICE

N/A.

METHOD OF EVALUATION

N/A.

CLOSING STATEMENT

Throughout the Cadet Program, cadets may be given many occasions to lead. To improve their leadership ability, cadets may incorporate the principles of leadership into their own leadership style. Cadets may learn from the situations discussed that they are never too young to use their influence in a positive manner.

INSTRUCTOR NOTES/REMARKS

Instructors are encouraged to research recent newsworthy articles of youth in the area that have positively influenced the environment or their community, to share as in-class stories.

REFERENCES

A0-010 CATO 11-03 D Cdts 2. (2006). *Cadet Program Mandate*. Ottawa, ON: Department of National Defence.

C0-112 (ISBN 0-8407-6744-7) Maxwell, J. C. (1993). *Developing the Leader Within You*. Nashville, Tennessee: Thomas Nelson Inc. Publishers.

C0-113 (ISBN 1-882664-12-4) Karnes, F. A. & Bean, S. M. (1995). *Leadership for Students: A Practical Guide for Ages 8-18*. Waco, Texas: Prufrock Press.

C0-131 Free The Children. (2007). *Craig Kielburger Biography*. Retrieved 13 March 2007, from <http://www.freethechildren.com/aboutus/craigmarc/craigkielburger.htm>.

C0-132 Kidz World. (2007). *Teen Protects White Bear*. Retrieved 13 March 2007, from <http://www.kidzworld.com/article/1065-teen-protects-white-bear>.

THIS PAGE INTENTIONALLY LEFT BLANK



COMMON TRAINING INSTRUCTIONAL GUIDE



SECTION 3

EO M203.03 – DISCUSS EFFECTIVE COMMUNICATION IN A PEER SETTING

Total Time:

30 min

PREPARATION

PRE-LESSON INSTRUCTIONS

Resources needed for the delivery of this lesson are listed in the lesson specification located in A-CR-CCP-702/PG-001, Chapter 4. Specific uses for said resources are identified throughout the Instructional Guide within the TP for which they are required.

Review the lesson content and become familiar with the material prior to delivering the lesson.

PRE-LESSON ASSIGNMENT

N/A.

APPROACH

An interactive lecture was chosen for this lesson to orient the cadets to effective communication in a peer setting, to generate interest and to present basic material.

INTRODUCTION

REVIEW

N/A.

OBJECTIVES

By the end of this lesson the cadet shall discuss effective communication in a peer setting.

IMPORTANCE

It is important for cadets to learn effective communication in a peer setting to continue to improve their leadership skills. Effectively communicating in a peer setting may improve the leadership skills of cadets because communication is the most basic way to influence others. Effective communication may be used to resolve and/or reduce problems and conflict. By experiencing the benefits of effective communication in a peer setting, cadets may enhance their self-confidence and self-esteem.

Teaching Point 1**Discuss How Communication Is Fundamental to Influencing Others**

Time: 10 min

Method: Interactive Lecture

Effective communication is a critical skill for leaders in a peer setting. Communication is the exchange of thoughts, messages and information. It is the process of sharing knowledge, interests, attitudes, opinions, feelings and ideas with others. Through communication one person can influence others. Effective communication may also be used to resolve and/or reduce problems and conflict.

COMMUNICATION IS A SKILL

Like any skill, the ability to communicate with competence must be learned and developed over a lifetime. Communication skills permit the flow of ideas from one individual to another or to a group, and vice versa. The process of communication can include both verbal and non-verbal messages.

NON-VERBAL COMMUNICATION

Non-verbal communication uses many channels for sending and receiving information. Information is received through all our senses (taste, sight, smell, touch and sound). Some aspects of non-verbal communication include:

Eye Contact. Looking directly at another person when speaking is an effective way of indicating sincerity and getting someone's attention.

Body Posture. The weight of the message being sent will be increased when facing the person being spoken to, standing or sitting closer to them and leaning forward. Using correct body posture when listening is also an effective way of indicating interest in the conversation.

Gestures. A message that has a body gesture attached to it takes on added emphasis.

Facial Expressions. When making a statement, make sure facial expressions agree with the message.

Voice Tone, Volume Changes. Shouting may cause people to become defensive, just a whispering may cause people to tune out the message. Make sure voice levels are correct for the space and that statements are convincing without being intimidating.

Being able to read non-verbal responses to communication, while leading in a peer setting, may help cadets understand how they are being perceived.

SENDING, RECEIVING AND RESPONDING TO A MESSAGE

Communication consists of three things: sending, receiving and responding to a message.

The sender must deliver a clear message, taking into consideration the characteristics of the individual(s) receiving the message. Is the person a child or an adult? Is there one person, or are there 20? These and similar factors all determine how the message should be sent.

Next, the message is received. It is important to remember that receivers translate what they have heard based on their own set of definitions, which may differ greatly for those of the sender.

The final component of communication is response. A response lets the sender know the message has been received. All three parts are necessary for effective communication.

CONFIRMATION OF TEACHING POINT 1

QUESTIONS

- Q1. Why are communication skills a fundamental part of leadership?
- Q2. List some aspects of non-verbal communication.
- Q3. Communication consists of three things, name them.

ANTICIPATED ANSWERS

- A1. Communication skills are a fundamental part of leadership because they permit the flow of ideas from one individual to another or to a group, and vice versa.
- A2. Some aspects of non-verbal communication include:
- eye contact,
 - body posture,
 - gestures,
 - facial expressions, and
 - voice tone, volume changes.
- A3. Communication consists of three things: sending, receiving and responding to a message.

Teaching Point 2

Explain the Three Styles of Communication

Time: 5 min

Method: Interactive Lecture

THREE STYLES OF COMMUNICATION

Aggressive Communication. A person who is an aggressive communicator puts their own wants and needs ahead of everyone else and they often ignore or belittle other people's concerns.

Aggressive communicators often:

- talk over people and interrupt;
- make sarcastic, demeaning or threatening remarks;
- consider only their own point of view; or
- stand too close, lean over you or in some other way make you feel physically uncomfortable.

Aggressive communication usually leads to hostility, anger and resentment.

Passive Communication. A person who is a passive communicator puts other people's wants and needs ahead of their own and often denies what they want or need.

Passive communicators often:

- hardly ever say what they want or need;
- let others make decisions for them;

- avoid conflict and disagreement at all costs; and
- drop hints rather than directly request that something gets done.

Passive communication usually leads to bad feelings and damages relationships.

Assertive Communication. A person who is an assertive communicator uses skills based on mutual respect. Assertive communicators can say how they see things and hear how others see things. They work towards outcomes that satisfy everyone.

Assertive communicators often:

- are open and honest about what they are thinking and feeling;
- make direct requests if they want something done, leaving the option to say “no”;
- respect themselves and show respect to others; and
- are able to disagree without creating bad feelings.

Assertive communication usually results in clear and open communication.

CONFIRMATION OF TEACHING POINT 2

QUESTIONS

- Q1. Name the three styles of communication.
- Q2. What are some characteristics of assertive communicators?
- Q3. Assertive communication usually results in what?

ANTICIPATED ANSWERS

- A1. The three styles of communication are aggressive, passive and assertive.
- A2. Assertive communicators often:
- are open and honest about what they are thinking and feeling;
 - makes direct requests if they want something done, leaving the option to say “no”;
 - respect themselves and show respect to others; and
 - are able to disagree without creating bad feelings.
- A3. Assertive communication usually results in clear and open communication.

Teaching Point 3

Discuss Assertive Communication

Time: 10 min

Method: Interactive Lecture

Assertive people use a number of important communication skills. They ask questions to gather information and check that they have understood correctly. Assertive people say what is on their mind in a direct yet courteous way so there is no hidden message.

USING “I” STATEMENTS

One of the most important skills that an assertive communicator uses is making “I” statements. Assertive people use “I” language. An assertive communicator uses statements like “I’d like...”, “I’d appreciate...”, “I think...” and “I feel”... etc. They own their own messages and speak for themselves. Their suggestions are not weighted with advice, commands, and “shoulds” or “oughts”. Their feedback is constructive and free from blame.

Non-verbally assertive people:

- make appropriate eye contact;
- sit or stand comfortably erect;
- use open gestures to support their comments;
- speak in a clear, steady, firm tone of voice; and
- maintain open, unchanging and relaxed facial expressions that accurately reflect their thoughts.

ACTIVE LISTENING SKILLS

Assertive people also use active listening skills. These skills include:

- repeating the conversation back to the speaker, in their own words, to understand the speaker’s meaning;
- not talking about themselves;
- letting the speaker take the lead by encouraging them back to the issue if the speaker digresses;
- concentrating fully on what the speaker is saying;
- asking for clarification if it is needed;
- acknowledging the speaker’s feelings; and
- allowing for silence.

CONFIRMATION OF TEACHING POINT 3

QUESTIONS

- Q1. Give three examples of “I” statements.
- Q2. Give some examples of non-verbal communication used by assertive people.
- Q3. Give some examples of active listening skills.

ANTICIPATED ANSWERS

- A1. “I’d like...”, “I’d appreciate...”, “I think...” and “I feel”... etc.
- A2. Non-verbally assertive people:
- make appropriate eye contact;
 - sit or stand comfortably erect;
 - use open gestures to support their comments;

- speak in a clear, steady, firm tone of voice; and
- maintain open, unchanging and relaxed facial expressions that accurately reflect their thoughts.

A3. Active listening skills include:

- repeating the conversation back to the speaker, in their own words, to understand the speakers meaning;
- not talking about themselves;
- letting the speaker take the lead by encouraging them back to the issue if the speaker digresses;
- concentrating fully on what the speaker is saying;
- asking for clarification if it is needed;
- acknowledging the speaker's feelings; and
- allowing for silence.

END OF LESSON CONFIRMATION

QUESTIONS

- Q1. Communication consists of three things; name them.
- Q2. What are some characteristics of assertive communicators?
- Q3. Why do assertive people use "I" statements?

ANTICIPATED ANSWERS

- A1. Communication consists of three things: sending, receiving and responding to a message.
- A2. Assertive communicators often:
- are open and honest about what they are thinking and feeling;
 - makes direct requests if they want something done, leaving the option to say "no";
 - respect themselves and show respect to others; and
 - are able to disagree without creating bad feelings.
- A3. Assertive people use "I" statements because they own their own messages and speak for themselves.

CONCLUSION

HOMEWORK/READING/PRACTICE

N/A.

METHOD OF EVALUATION

N/A.

CLOSING STATEMENT

Effective communication is a critical talent for leaders. Effectively communicating in a peer setting may improve the leadership skills of cadets because communication is the most basic way to influence others. Using their influence in a peer setting, cadets may resolve and/or reduce problems and conflict and it may enhance cadets' self-confidence and self-esteem.

INSTRUCTOR NOTES/REMARKS

N/A.

REFERENCES

C0-022 (ISBN 0-02864-207-4) Cole, K. (2002). *The Complete Idiots Guide to Clear Communications*. Indianapolis, IN: Pearson Education, Inc.

C0-115 (ISBN 0-7879-4059-3) Van Linden, J. A. & Fertman, C. I. (1998). *Youth Leadership*. San Francisco, California: Jossey-Bass Inc.

C0-144 Colver, E. & Reid, M. (2001). *Peacebuilders 2: Peer Helping*. Ottawa, ON: YouCAN.

THIS PAGE INTENTIONALLY LEFT BLANK



COMMON TRAINING INSTRUCTIONAL GUIDE



SECTION 4

EO M203.04 – DEMONSTRATE POSITIVE GROUP DYNAMICS

Total Time:

60 min

PREPARATION

PRE-LESSON INSTRUCTIONS

Resources needed for the delivery of this lesson are listed in the lesson specification located in A-CR-CCP-702/PG-001, Chapter 4. Specific uses for said resources are identified throughout the Instructional Guide within the TP for which they are required.

Review the lesson content and become familiar with the material prior to delivering the lesson.

PRE-LESSON ASSIGNMENT

N/A.

APPROACH

A group discussion was chosen for TP1 as it allows the cadets to interact with their peers and share their knowledge, experiences, opinions, and feelings about positive group dynamics.

An interactive lecture was chosen for TP2 to orient the cadets to positive group dynamics, to generate interest and to present basic material.

An in-class activity was chosen for TP3 as an interactive way to provoke thought and stimulate interest among cadets.

INTRODUCTION

REVIEW

The review for this lesson will be from EO M103.03 (Participate in Team-Building Activities).

QUESTIONS

- Q1. What are the characteristics of a successful team?
- Q2. What are the advantages of effective teamwork?

ANTICIPATED ANSWERS

A1. The characteristics of a successful team are:

- clear communication,
- mutual cooperation and support,
- share a common goal, and
- high esprit de corps.

A2. The advantages of effective teamwork are:

- everyone is included ensuring a better outcome;
- tasks are often easier when more people are involved; and
- communication skills are developed.



Write down the characteristics of a successful team and advantages of effective teamwork on a whiteboard/flipchart/OHP.

OBJECTIVES

By the end of this lesson the cadet shall be expected to demonstrate positive group dynamics.

IMPORTANCE

It is important for cadets to learn about positive group dynamics to continue to improve their leadership skills. By experiencing the benefits of working as a supportive and encouraging team member in a peer setting, cadets may enhance their self-confidence and self-esteem.

Teaching Point 1

Time: 10 min

Discuss Positive Group Dynamics

Method: Group Discussion

BACKGROUND KNOWLEDGE



The point of the group discussion is to draw the following information from the group using the tips for answering/facilitating discussion and the suggested questions provided.

According to “Youth Leadership”, as individuals begin to work in groups, they discover that there are patterns of group development; they learn that all groups develop in predictable ways. Information about group development and dynamics dispels myths about groups. One myth many cadets believe is that “nobody feels the way I do.” Feelings of isolation and detachment are common among individuals who enter a new group. As cadets learn more about the tasks necessary for groups to evolve, they discover that there is more to forming a positively functioning group than just bringing people together.

Cadets learn why people have come to the group. Through activities, cadets share what they are feeling and why they are there. As cadets discover how groups operate and as they learn about the kinds of forces that exist within groups, they begin to understand how they fit into their own group.

In order for a peer group or team to perform at its highest level, each member of the team should display positive group dynamics. To demonstrate positive group dynamics, group members should:

- contribute to the group's goal;
- exhibit trust in the group;
- create a safe environment for others to share their opinions;
- follow the leader;
- finish the task;
- display esprit de corps; and
- appreciate others within the group.

GROUP DISCUSSION

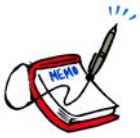


TIPS FOR ANSWERING/FACILITATING DISCUSSION

- Establish ground rules for discussion, e.g. everyone should listen respectfully; don't interrupt; only one person speaks at a time; no one's ideas should be made fun of; you can disagree with ideas but not with the person; try to understand others as much as you hope they understand you; etc.
- Sit the group in a circle, making sure all cadets can be seen by everyone else.
- Ask questions that will provoke thought; in other words avoid questions with yes or no answers.
- Manage time by ensuring the cadets stay on topic.
- Listen and respond in a way that indicates you have heard and understood the cadet. This can be done by paraphrasing their ideas.
- Give the cadets time to respond to your questions.
- Ensure every cadet has an opportunity to participate. One option is to go around the group and have each cadet answer the question with a short answer. Cadets must also have the option to pass if they wish.
- Additional questions should be prepared ahead of time.

SUGGESTED QUESTIONS

Q1. What attributes must a cadet display within the team, to help the team be successful?



Have cadets brainstorm a list of the attributes that enable positive group dynamics. Copy the list on a whiteboard/flipchart/OHP.

Q2. Are there some attributes that contribute more to the success of the team than other attributes? Why or why not?

Q3. Besides cadets, where else would these attributes be advantageous in a peer setting?



The attributes brainstormed by the cadets may not match the attributes in the background knowledge. Correct cadets during the discussion if the attributes suggested do not match the criteria for positive group dynamics.



Other questions and answers will develop throughout the group discussion. The group discussion should not be limited to only those suggested.



Reinforce those answers given and comments made during the group discussion, ensuring the teaching point has been covered.

CONFIRMATION OF TEACHING POINT 1

The cadets' participation in the group discussion will serve as confirmation of this TP.

Teaching Point 2

Explain How to Display Positive Group Dynamics

Time: 25 min

Method: Interactive Lecture

When placed within a peer setting, each cadet should display positive group dynamics.



After explaining each point below, have cadets give examples of when they have seen the attribute displayed.

To display positive group dynamics, cadets must:

- Contribute to group discussions by providing input. This means contributing to every discussion. Even if a cadet has no new or original ideas, agree or disagree with other member's suggestions. Ask questions. Offer support and volunteer to take on extra assignments.
- Be motivated. Be enthusiastic and ensure the best effort each time when working in a team setting.

- Participate in establishing the team's goals. Cadets will have to work to meet the team's goals, so cadets should have a say in determining them. Ensure group goals are consistent with the aims of the cadet organization.
- Try new things. Do not be afraid to take risks. Trying new things shows courage, and courage is a leadership quality. Remember the turtle: it is perfectly safe when it stays in its shell, but to move ahead, the turtle must stick its neck and feet out.
- Be sensitive to other points of view. Listen to the opinions of other team members. Do not be afraid to express your view even if it is different or even the opposite of everybody else's. Deal respectfully with teammates who disagree. Be willing to compromise to achieve a consensus.
- Know teammates' strengths and weaknesses. If members know their teammates' talents and limitations, it enables the team to use all its personnel to its best advantage. Being aware of teammates individual habits may make working with them easier.
- Increase self-confidence through positive self-talk. Focusing on one's positive characteristics leads to increased self-confidence. To feel better about yourself, concentrate on the things done well and compliment yourself on those things. This is not always easy.
- Be cooperative. Be polite, be a team player, and support your teammates. Help them by distributing work evenly and by sharing information; do not compete.
- Resolve conflicts as quickly as possible at the lowest and most appropriate level. As mentioned in the CHAP program, if teammates have a conflict, find a solution. Do not let problems fester and do not hold a grudge. Once conflicts are resolved, let them go.
- Celebrate successes. When the team completes a task or completes a goal, share in the enjoyment. Have a quick team meeting and compliment all team members on a job well done. Praise team members in front of others. Show appreciation to teammates who have been especially helpful. Everyone likes to be congratulated. This may lead to increased feelings of enthusiasm and self-confidence by members of the team.



Compare the list of attributes developed during the group discussion with the attributes taught in TP2.

CONFIRMATION OF TEACHING POINT 2

QUESTIONS

- Q1. How can cadets contribute to group discussions?
- Q2. Why should cadets not be afraid to try new things within a team setting?
- Q3. Why should successes be celebrated?

ANTICIPATED ANSWERS

- A1. Cadets can contribute to group discussions by providing input. This means contributing to every discussion.
- A2. Trying new things shows initiative, and initiative is a leadership quality.
- A3. Successes should be celebrated because everyone likes to be congratulated. This may lead to increased feelings of enthusiasm and self-confidence by members of the team.

Teaching Point 3

Demonstrate Positive Group Dynamics

Time: 15 min

Method: In-Class Activity



It is very difficult to find an activity that will display all the aspects of positive group dynamics at once. This activity was chosen to give cadets the opportunity to be sensitive to other points of view, to listen without interrupting, to learn their teammates' strengths and weaknesses and to increase their self-confidence through positive self-talk.

ACTIVITY

OBJECTIVE

The objective of this activity is to have cadets demonstrate positive group dynamics within a peer setting to build mutual support and trust.

RESOURCES

N/A.

ACTIVITY LAYOUT

N/A.

ACTIVITY INSTRUCTIONS



Remind cadets that the ability to build mutual trust is based on being able to communicate openly with members of the team.

1. Ask the cadets to find a partner, preferably someone they do not know well, or someone they would like to know better.
2. Have the cadets sit facing each other.
3. Have the cadets decide who will go first. Tell them to make eye contact with one another and get comfortable. Cadets must maintain an open body posture (no crossing of the arms or legs and no slouching). Cadets must tell their partners "What I like about myself." Cadets must speak for two minutes.
4. The passive partner cannot say a word, but through body language, (head nodding, leaning forward, smiling, etc.) must express a keen interest in what is being said.

5. At the end of two minutes, have the cadets switch roles and repeat the speaking/listening exercise.
6. Have cadets switch back to their original positions. Tell them to make eye contact with one another and get comfortable. Cadets must maintain an open body posture (no crossing of the arms or legs and no slouching). Have the first cadet speak about "What I don't like about myself". Cadets must speak for one minute.
7. The passive partner cannot say a word, but through body language, (head nodding, leaning forward, smiling, etc.) must express a keen interest in what is being said.
8. At the end of one minute, have cadets switch roles and repeat the speaking/listening exercise.
9. After everyone is finished speaking/listening, conduct a short de-brief with the cadets to include the following questions:
 - Was it difficult to remain passive, silent and interested?
 - Was it easier to listen to another cadet speaking about their strengths or their weaknesses? Why?
 - Was it easier to speak about their own strengths or their own weaknesses? Why?
 - Did having the listener show interest through body language help them be more open with their remarks? Why?

SAFETY

N/A.



Ensure cadets understand that this activity was chosen to give them an opportunity to demonstrate positive group dynamics by being sensitive to other points of view, listening without interrupting, learning your teammates' strengths and weaknesses and increasing their self-confidence through positive self-talk.

END OF LESSON CONFIRMATION

The cadets' participation in the activity in TP3 will serve as confirmation of this lesson.

CONCLUSION

HOMEWORK/READING/PRACTICE

N/A.

METHOD OF EVALUATION

N/A.

CLOSING STATEMENT

It is important to demonstrate positive group dynamics by being a supportive and encouraging team member within a peer setting. As a full participant in team activities, cadets may enjoy their tasks more and they may make more effective contributions to the team's success. This may assist in building the cadet's self-confidence and self-esteem and may improve their basic leadership skills.

INSTRUCTOR NOTES/REMARKS

The instructor shall provide a safe learning and team-building environment in which the cadets will display and demonstrate positive group dynamics.

REFERENCES

C0-028 (ISBN 0-07-046513-4) Newstrom, J. & Scannell, E. (1998). *The Big Book of Team Building Games*. USA: McGraw-Hill Companies.

C0-114 (ISBN 0-02-863656-2) Pell, A. R. (1999). *The Complete Idiot's Guide to Team Building*. USA: Alpha Books.

C0-115 (ISBN 0-7879-4059-3) Van Linden, J. A. & Fertman, C. I. (1998). *Youth Leadership*. San Francisco, California: Jossey-Bass Inc.



COMMON TRAINING INSTRUCTIONAL GUIDE



SECTION 5

EO M203.05 – DISCUSS INFLUENCE BEHAVIOURS

Total Time:

30 min

PREPARATION

PRE-LESSON INSTRUCTIONS

Resources needed for the delivery of this lesson are listed in the lesson specification located in A-CR-CCP-702/PG-001, Chapter 4. Specific uses for said resources are identified throughout the Instructional Guide within the TP for which they are required.

Review the lesson content and become familiar with the material prior to delivering the lesson.

Make six copies of the handouts at Annexes A, B and C for the activities in TP1 to TP3.

PRE-LESSON ASSIGNMENT

N/A.

APPROACH

An in-class activity was chosen for TP1 to TP3 as an interactive way to provoke thought and stimulate an interest among cadets.

A group discussion was chosen for TP4 as it allows the cadets to interact with their peers and share their knowledge, experiences, opinions and feelings about influence behaviours.

INTRODUCTION

REVIEW

N/A.

OBJECTIVES

By the end of this lesson the cadet shall be expected to discuss influence behaviours.

IMPORTANCE

It is important for cadets to acknowledge the influence they have in a peer setting. Learning influence behaviours may enable cadets to choose the correct influence behaviour for the situation to successfully accomplish tasks in a peer setting.

Teaching Point 1**Perform in a Skit to Portray Directive Behaviour**

Time: 5 min

Method: In-Class Activity



The earliest studies of leadership commonly referred to influence behaviours as leadership styles or approaches. The three influence behaviours listed below are chosen from a spectrum of eight influence behaviours.

ACTIVITY**OBJECTIVE**

The objective of this activity is to have cadets perform in a skit to portray directive behaviour and to recognize its use.

RESOURCES

Skit located at Annex A.

ACTIVITY LAYOUT

N/A.

ACTIVITY INSTRUCTIONS

1. Have cadets volunteer to perform in the skit.
2. Distribute the scripts to the cadets who volunteered.
3. Have cadets perform the skit.
4. Ask cadets to brainstorm a list of traits they noticed about Cadet Purple in this skit.
5. Copy the list on a whiteboard/flipchart/OHP.
6. Have cadets return the scripts.



Upon completion of the brainstorming conclude by summarizing directive behaviour before moving on to the next TP.

DIRECTIVE BEHAVIOUR

Generally, directive behaviour involves telling teammates what they are to do, and possibly, when, how and to what standard they are to accomplish the task. Directive behaviour may be expressed as a simple request, a formal order or something in between. Directive behaviour is appropriate when passing on and executing a superior's objective, when assigning and co-ordinating tasks and when teammates lack information or experience and need guidance.

Directive behaviour is used most often in emergency situations where time, safety, and control of personnel are factors. Another example is drill. Drill is normally conducted using directive behaviour.

SAFETY

N/A.

CONFIRMATION OF TEACHING POINT 1**QUESTIONS**

- Q1. What does directive behaviour involve?
- Q2. When is directive behaviour appropriate?
- Q3. Where is directive behaviour used most often?

ANTICIPATED ANSWERS

- A1. Directive behaviour involves telling teammates what they are to do, and possibly, when, how and to what standard.
- A2. Directive behaviour is appropriate when passing on and executing a superior's objective, when assigning and co-ordinating tasks and when teammates lack information or experience and need guidance.
- A3. Directive behaviour is used most often in emergency situations where time, safety, and control of personnel are factors.

Teaching Point 2**Perform in a Skit to Portray Persuasive Behaviour**

Time: 5 min

Method: In-Class Activity

ACTIVITY**OBJECTIVE**

The objective of this activity is to have cadets perform in a skit to portray persuasive behaviour and to recognize its use.

RESOURCES

Skit located at Annex B.

ACTIVITY LAYOUT

N/A.

ACTIVITY INSTRUCTIONS

1. Have cadets volunteer to perform in the skit.
2. Distribute the scripts to the cadets who volunteered.
3. Have cadets perform the skit.
4. Ask cadets to brainstorm a list of traits they noticed about Cadet Purple in this skit.

5. Copy the list on a whiteboard/flipchart/OHP.
6. Have cadets return the scripts.



Upon completion of the brainstorming conclude by summarizing persuasive behaviour before moving on to the next TP.

PERSUASIVE BEHAVIOUR

Generally, persuasive behaviour is intended to influence decision-making and motivation. This is accomplished by explaining to, or convincing others why a certain course of action is necessary. Persuasive behaviour may involve rational argument based on facts, reason and logic and/or inspirational appeals which motivate others. This behaviour may allow teammates to understand the potential benefits to them created by the course of action and should aid teammates in their commitment to the task. Persuasive behaviour is appropriate to secure agreement or commitment and when particularly high or sustained levels of effort are required to accomplish a task.

There are many situations when persuasive behaviour is used. These may include problem-solving, counselling, teaching, etc. Persuasive behaviour is usually effective in a peer setting if all teammates display positive group dynamics.

SAFETY

N/A.

CONFIRMATION OF TEACHING POINT 2

QUESTIONS

- Q1. When is persuasive behaviour used?
- Q2. What are the potential benefits of the persuasive behaviour?
- Q3. Name three situations where persuasive behaviour may be used?

ANTICIPATED ANSWERS

- A1. Persuasive behaviour is used to influence decision-making and motivate others.
- A2. Persuasive behaviour may allow teammates to understand the potential benefits to them created by the course of action and should aid teammates in their commitment to the task.
- A3. Persuasive behaviour may be used when problem-solving, counselling, teaching, etc.

Teaching Point 3**Perform in a Skit to Portray Participative Behaviour**

Time: 5 min

Method: In-Class Activity

ACTIVITY**OBJECTIVE**

The objective of this activity is to have cadets perform in a skit to portray participative behaviour and to recognize its use.

RESOURCES

Skit found at Annex C.

ACTIVITY LAYOUT

N/A.

ACTIVITY INSTRUCTIONS

1. Have cadets volunteer to perform in the skit.
2. Distribute the scripts to the cadets who volunteered.
3. Have cadets perform the skit.
4. Ask cadets to brainstorm a list of traits they noticed about Cadet Purple in this skit.
5. Copy the list on a whiteboard/flipchart/OHP.
6. Have cadets return the scripts.



Upon completion of the brainstorming conclude by summarizing participative behaviour before moving on to the next TP.

PARTICIPATIVE BEHAVIOUR

Generally, participative behaviour involves sharing decision-making with others. The primary objective is to improve the quality and/or acceptance of decisions. Participative behaviours employ two basic methods – individual or group consultations and joint decision-making. Obtaining advice, opinions and recommendations from others before sharing decision-making is essential. Sometimes teammates possess critical information or expertise and that knowledge may make the difference between success or failure of the task. The use of the participative behaviour depends on the availability of time to involve others. Teammates expect to be consulted on and have a voice in decisions that affect them.

There are many situations when participative behaviour is used including problem-solving, participating in team-building activities, resolving conflict in a peer setting, etc. Participative behaviour is usually effective in a peer setting because all teammates have a part to play in making the decision.

SAFETY

N/A.

CONFIRMATION OF TEACHING POINT 3

QUESTIONS

- Q1. What does participative behaviour involve?
- Q2. What are the two basic methods of employing persuasive behaviours?
- Q3. Name three situations where participative behaviour may be used.

ANTICIPATED ANSWERS

- A1. Participative behaviour involves sharing decision-making with others.
- A2. Participative behaviours employ two basic methods – individual or group consultations and joint decision-making.
- A3. Participative behaviour may be used during problem solving, participating in team-building activities, resolving conflict in a peer setting, etc.

Teaching Point 4

Discuss Situations in Which Cadets May Employ the Various Influence Behaviours in Peer Group Settings

Time: 10 min

Method: Group Discussion

BACKGROUND KNOWLEDGE



The point of the group discussion is to draw the following information from the group using the tips for answering/facilitating discussion and the suggested questions provided.

Different influence behaviours will be used during different situations. A good leader may use a combination of behaviours based on the situation, the experience of the followers, the time to get a task done, etc. Each of the influence behaviours has its place and can be used effectively under the correct conditions.

GROUP DISCUSSION



TIPS FOR ANSWERING/FACILITATING DISCUSSION

- Establish ground rules for discussion, e.g. everyone should listen respectfully; don't interrupt; only one person speaks at a time; no one's ideas should be made fun of; you can disagree with ideas but not with the person; try to understand others as much as you hope they understand you; etc.
- Sit the group in a circle, making sure all cadets can be seen by everyone else.
- Ask questions that will provoke thought; in other words avoid questions with yes or no answers.
- Manage time by ensuring the cadets stay on topic.
- Listen and respond in a way that indicates you have heard and understood the cadet. This can be done by paraphrasing their ideas.
- Give the cadets time to respond to your questions.
- Ensure every cadet has an opportunity to participate. One option is to go around the group and have each cadet answer the question with a short answer.
- Cadets must also have the option to pass if they wish.
- Additional questions should be prepared ahead of time.

SUGGESTED QUESTIONS

- Q1. When is directive behaviour most effective at cadets or at school?
- Q2. When is persuasive behaviour most effective at cadets or at school?
- Q3. When is participative behaviour most effective at cadets or at school?
- Q4. What are the differences between persuasive and participative behaviours?



Other questions and answers will develop throughout the group discussion. The group discussion should not be limited to only those suggested.



Reinforce those answers given and comments made during the group discussion, ensuring the teaching point has been covered.

CONFIRMATION OF TEACHING POINT 4

The cadets' participation in the group discussion will serve as confirmation of this TP.

END OF LESSON CONFIRMATION

The cadets' participation in the activities in TP1 to TP3 and the group discussion in TP4 will serve as the confirmation of this lesson.

CONCLUSION

HOMEWORK/READING/PRACTICE

N/A.

METHOD OF EVALUATION

N/A.

CLOSING STATEMENT

Through the Cadet Program there may be many opportunities for cadets to influence their peers. Choosing the correct influence behaviour for a situation may assist them in accomplishing tasks in a peer setting.

INSTRUCTOR NOTES/REMARKS

N/A.

REFERENCES

A0-047 A-PA-005-000/AP-004 DND. (2005). *Leadership in the Canadian Forces: Conceptual Foundations*. Ottawa, ON: Department of National Defence.

A0-048 A-PA-005-000/AP-003 DND. (2005). *Leadership in the Canadian Forces: Doctrine*. Ottawa, ON: Department of National Defence.

C0-113 (ISBN 1-882664-12-4) Karnes, F. A. & Bean, S. M. (1995). *Leadership for Students: A Practical Guide for Ages 8-18*. Waco, Texas: Prufrock Press.

C0-115 (ISBN 0-7879-4059-3) Van Linden, J. A. & Fertman, C. I. (1998). *Youth Leadership*. San Francisco, California: Jossey-Bass Inc.

SKIT FOR DIRECTIVE BEHAVIOUR

(**Setting:** Six first year cadets at a CSTC are getting ready for a barrack inspection to take place in one hour.)

Cadet Red: Okay we have a barrack inspection in an hour, we better get ready.

Cadet Orange: Do we have a uniform inspection at the same time or is it just the room?

Cadet Red: I don't know. Does anyone else?

Cadet Purple: Yes, I know, I asked the staff cadet. We're having a room and uniform inspection at the same time. We're supposed to wear our T-shirts, cadet trousers and parade boots.

Cadet Grey: Man, that's a lot of stuff in just an hour.

Cadet Yellow: No kidding.

Cadet Pink: I don't think I'll be ready.

Cadet Purple: We need to get stuff done fast, so here's what should happen. You two, Cadet Red and Cadet Orange will make the beds and sweep the room. That takes care of the room.

Cadet Grey: What about our uniforms?

Cadet Purple: You, Cadet Grey, take everyone's T-shirts and iron them.

Cadet Yellow: And trousers and boots?

Cadet Purple: You, Cadet Yellow, take everyone's trousers and iron them and Cadet Pink and I will do everyone's boots.

Cadet Red: That didn't take long to come up with a plan. I hope we get everything done.

Cadet Purple: We will, if everyone does their job and right now.

Cadet Red: I'm not great at making beds but I'll do what I'm told.

Cadet Orange: I'm okay at beds, we'll do fine.

Cadet Purple: Okay everyone give your T-shirt to Cadet Grey, your trousers to Cadet Yellow and give me your boots. Everyone, listen up: we have a lot to do and not a lot of time... so get at it. Be back here in 40 minutes.

Cadet Pink: I'll get my polishing kit.

(ALL CADETS PRETEND TO DELIVER REQUIRED ITEMS TO THE CADET WHO HAS BEEN TASKED.)

(40 MINUTES PASS.)

(ALL CADETS RETURN TO THE ROOM.)

Cadet Red: As everyone can see, the beds are done and the room is swept.

Cadet Orange: The beds aren't great, but they'll pass inspection.

Cadet Purple: How did the ironing go?

Cadet Grey: Here are the T-shirts ready to go. I've never ironed that many in such a short time. I hope they pass the inspection.

Cadet Yellow: All the trousers have the right creases and I don't see any railroad tracks.

Cadet Pink: And we finished everyone's boots.

Cadet Purple: Let's get into our uniforms right now because we're running out of time.

(EVERYONE GETS READY FOR THE INSPECTION.)

Cadet Purple: We look okay. I'm pretty sure we will pass the inspection. Okay everyone stand at attention by your bed, because here comes the staff cadet.

SKIT FOR THE PERSUASIVE BEHAVIOUR

(Setting: Six second year cadets at CSTC getting ready for a barrack inspection to take place in one hour.)

Cadet Red: Okay we have a barrack inspection in an hour, we had better get ready.

Cadet Orange: Do we have a uniform inspection at the same time or is it just the room?

Cadet Purple: I asked the staff cadet. We're having a room and uniform inspection at the same time. We're supposed to wear our T-shirts, cadet trousers and parade boots.

Cadet Grey: Man, that's a lot of stuff in just an hour.

Cadet Yellow: No kidding.

Cadet Pink: I don't think I'll be ready.

Cadet Purple: We can be ready, we just need a plan. We need to get beds made, the room swept, T-shirts and trousers ironed and boots done.

Cadet Grey: That's a lot.

Cadet Purple: I have an idea to be able to everything done on time. Would you guys like to hear it?

(EVERYONE NODS IN AGREEMENT.)

Cadet Purple: I think we should divide the work that way we will be able to get things done fast. And if we get people to volunteer to do what they're good at... that should help too. Does that plan make sense to everyone?

(EVERYONE NODS IN AGREEMENT.)

Cadet Purple: I know if we work as a team, we can get everything finished on time and we will look great for the inspection. Okay, so which of us likes making beds?

Cadet Pink: I do. I want to make beds.

Cadet Purple: Anyone else?

Cadet Red: Not me, I like ironing T-shirts, I'll do that.

Cadet Purple: That sounds good. Anyone else want to volunteer?

Cadet Yellow: I like to polish boots. That's what I'll do.

Cadet Orange: Me too. I'll help Cadet Yellow.

Cadet Grey: I don't mind ironing. I'll press everyone's trousers.

Cadet Purple: That leaves me to help with making beds and sweeping the room. Now that everyone has a task, we need to give out our T-shirts, trousers and boots.

(ALL CADETS PRETEND TO DELIVER REQUIRED ITEMS TO THE CADET WHO HAS BEEN TASKED.)

Cadet Red: How long does everyone think this will take?

Cadet Purple: I think it should take about 40 minutes. Does that sound right?

(EVERYONE NODS IN AGREEMENT.)

Cadet Purple: Can everyone be back in 40 minutes?

Cadet Orange: No problem. Let's all be back in 40 minutes.

(EVERYONE NODS IN AGREEMENT.)

(40 MINUTES PASS.)

(ALL CADETS RETURN TO THE ROOM.)

Cadet Purple: As you can see the beds look really good. Thanks Cadet Pink. How did everyone else do?

Cadet Red: T-shirts are finished and look good.

Cadet Yellow: Boots are polished and very shiny. Thanks Cadet Orange.

Cadet Orange: Thanks, we make a good team.

Cadet Grey: Trousers are done too and if I do say so...they look good.

Cadet Purple: I think it's time to get into our uniforms 'cause I believe we're running out of time.

(EVERYONE GETS READY FOR THE INSPECTION.)

Cadet Purple: We look awesome, I know we will pass the inspection. Okay everyone, please stand at attention by your bed, because here comes the staff cadet.

SKIT FOR THE PARTICIPATIVE BEHAVIOUR

(**Setting:** Six senior cadets at CSTC getting ready for a barrack inspection to take place in one hour.)

Cadet Red: Okay we have a barrack inspection in an hour, we had better get ready.

Cadet Orange: Do we have a uniform inspection at the same time or is it just the room?

Cadet Purple: I asked the staff cadet. We're having a room and uniform inspection at the same time. We're supposed to wear our T-shirts, cadet trousers and parade boots.

Cadet Grey: Man, that's a lot of stuff in just an hour.

Cadet Yellow: It's not like we haven't done this before. We'll be okay.

Cadet Grey: We just need to get organized.

Cadet Purple: Let's make a plan. Any ideas?

Cadet Yellow: I know we are going to have to divide up the work, but how?

Cadet Red: What if we pick our jobs from a hat? That could work.

Cadet Grey: How about just doing what we want to do?

Cadet Yellow: I thought, maybe, we could do what we're good at.

Cadet Purple: I really like that idea.

Cadet Orange: Me too, I like doing what I'm good at.

Cadet Red: Okay, sounds good.

Cadet Pink: I'm on board.

Cadet Grey: Besides if we do what we're good at, everything should take less time.

Cadet Purple: Okay so who's good at what?

Cadet Pink: I'm really good at ironing T-shirts.

Cadet Purple: Okay, that's your job and the team is expecting good things.

Cadet Red: My speciality is polishing boots. That should be my task.

Cadet Purple: That's your assignment then. Go ahead.

Cadet Yellow: I am an expert boot polisher. I'll assist Cadet Red.

Cadet Orange: I make the best beds. I should do that.

Cadet Grey: I'm good at making beds too and I'll sweep the floor.

Cadet Purple: Go to it, both of you. I iron trousers very well. That's what I'll do, and I'll stay out of everyone else's business. Okay let's get at it.

(EVERYONE NODS IN AGREEMENT.)

Cadet Red: How long does everyone think this will take?

Cadet Grey: About 40 minutes?

Cadet Orange: Sound goods. Be back in 40 minutes then.

(ALL CADETS PRETEND TO DELIVER REQUIRED ITEMS TO THE CADET WHO HAS BEEN TASKED.)

(40 MINUTES PASS.)

(ALL CADETS RETURN TO THE ROOM.)

Cadet Purple: Wow, this room looks really good. Excellent job, Cadet Orange and Cadet Grey. How did everyone else do?

Cadet Pink: T-shirts are finished and look awesome.

Cadet Yellow: Boots are polished and very shiny. Thanks Cadet Red.

Cadet Red: Thanks, we make a good team.

Cadet Purple: Trousers are done too and if I do say so...they look really good. I think it's time to get into our uniforms because I believe we're running out of time.

(EVERYONE GETS READY FOR THE INSPECTION.)

Cadet Purple: We look excellent, I know this team will pass the inspection. Okay everyone, please stand at attention by your bed, because here comes the staff cadet.



COMMON TRAINING INSTRUCTIONAL GUIDE



SECTION 6

EO M203.06 – EMPLOY PROBLEM SOLVING

Total Time:

60 min

PREPARATION

PRE-LESSON INSTRUCTIONS

Resources needed for the delivery of this lesson are listed in the lesson specification located in A-CR-CCP-702/PG-001, Chapter 4. Specific uses for said resources are identified throughout the Instructional Guide within the TP for which they are required.

Review the lesson content and become familiar with the material prior to delivering the lesson.

Copy handouts located at Annex A for each cadet.

PRE-LESSON ASSIGNMENT

N/A.

APPROACH

An interactive lecture was chosen for TP1 to orient the cadets to problem solving.

An in-class activity was chosen for TP2 as an interactive way to provoke thought, stimulate an interest among cadets and present problem solving.

A group discussion was chosen for TP3 as it allows the cadets to interact with their peers and share their knowledge, experiences, and opinions about problem solving.

INTRODUCTION

REVIEW

N/A.

OBJECTIVES

By the end of this lesson the cadet shall employ problem solving.

IMPORTANCE

One of the qualities of leadership is problem solving. As cadets become leaders within a peer setting they will use this quality more often. By having some tools to solve problems cadets may have an easier time to resolve them.

Teaching Point 1**Explain Problem Solving**

Time: 20 min

Method: Interactive Lecture

A Problem. This is a doubtful or difficult matter requiring a solution.

Red Star cadets deal with varying problems daily. We all possess a natural ability to solve dilemmas that may take little effort or planning such as trying to decide with our friends what to do on a Saturday night or getting up to go to school. However, when faced with more complex matters like working with a group on a cadet or school project or finding more than one solution to a problem, a more efficient methodology than trial and error analysis may be required.

Trial and Error Analysis. This method used to solve problems if there is a great deal of time available and the possible outcomes are not serious.

A PROBLEM-SOLVING PROCESS

Logical Analysis. One of the processes to solve problems is logical analysis, if there is sufficient time available for consideration of all the options. Logical analysis helps reduce a complex thought process into a simple format. However, some problems are very simple so all the steps in the process may not be used. If the team follows these steps, they should be able to create a plan to implement a solution.

When a task is assigned to cadets in a peer setting, the cadets should follow all the steps in the logical analysis process. If a problem develops that cadets within a peer setting must solve, without being directed to do so, the cadets should begin the logical analysis at step 2.

Steps in Logical Analysis:

1. **Confirm the Task.** By understanding both the problem and the aim or intent of the person assigning the task, the team has the freedom to act within their initiative to lead the team to success, especially when factors or plans change.
2. **Identify the Problem(s).** Once a problem is understood, the team must consider the problem or challenges that may occur in the implementation. This usually requires breaking the problem down into its component parts (“do this, then this, then this...”).
3. **Determine the “Critical Factor”.** There is usually one overriding problem in which all other issues will depend. This is called the CRITICAL FACTOR. Once identified, a plan to solve the problem can be formed around solving the critical factor.
4. **Develop Alternate Solutions.** Create as many possible solutions as time allows, drawing from the experience, knowledge and initiative of the team.
5. **Compare Alternatives.** Each solution must then be compared by the team in order to decide on the best solution. To decide which solution is the best, some questions may be asked:
 1. Which solution is the simplest?
 2. Which solution is the safest? What is the worst possible outcome? What are the dangerous elements?
 3. Which solution is the most flexible?
 4. Which solution uses available resources in an economical manner?
 5. Which solution will solve the critical factor and all other problems?

6. **Determine the Best Solution.** The team should choose the best solution to implement the plan of action.
 7. **Implement the Solution.** The team should create a plan to implement the solution and get the problem solved. If a plan does not work like the team wanted, they may try another of the alternative solutions.
 8. **Evaluate the Plan and the Implementation.** The team should evaluate performance once the problem is solved. The team should examine the implementation of the solution and the needs that may not have been anticipated. Questions may include:
 1. Was the solution a good one?
 2. Was the plan to implement the solution a success?
 3. What can we do to improve the plan or the implementation for the next time?
 4. What lessons were learned?
-

CONFIRMATION OF TEACHING POINT 1

QUESTIONS

- Q1. What is the definition of a problem?
- Q2. List the steps in Logical Analysis.
- Q3. List some questions that should be asked to evaluate the plan and implementation.

ANTICIPATED ANSWERS

- A1. A problem is a doubtful or difficult matter requiring a solution.
- A2. The steps in Logical Analysis are:
 1. confirm the task;
 2. identify the problem(s);
 3. determine the “Critical Factor”;
 4. develop alternate solutions;
 5. compare alternatives;
 6. determine the best solution;
 7. implement the solution; and
 8. evaluate the plan and the implementation.
- A3. Questions may include:
 1. Was the solution a good one?
 2. Was the plan to implement the solution a success?
 3. What can we do to improve the plan or the implementation for the next time?
 4. What lessons were learned?

Teaching Point 2

**Conduct a Writing Activity Where Cadets Solve Problems
Using the Technique From TP1**

Time: 10 min

Method: In-Class Activity

ACTIVITY

OBJECTIVE

The objective of this activity is for cadets to follow the problem solving steps in a written format.

RESOURCES

- 8.5 x 11 inch paper,
- Pen/pencil, and
- Scenario at Annex A.

ACTIVITY LAYOUT

N/A.

ACTIVITY INSTRUCTIONS

Distribute the problem scenario located at Annex A to each cadet.

Instruct cadets to write down in point form how they would solve the problem. Cadets must list at least three possible solutions to solve the problem.



Ensure cadets follow all the steps in the process.

SAFETY

N/A.

CONFIRMATION OF TEACHING POINT 2

The cadets' participation in the activity will serve as the confirmation of this TP.

Teaching Point 3**Conduct a Discussion Where Cadets Explain Their Choices
From the Problem-solving Exercise**

Time: 20 min

Method: Group Discussion

BACKGROUND KNOWLEDGE

The point of the group discussion is to draw the following information from the group using the tips for answering/facilitating discussion and the suggested questions provided.

Ask for volunteers to share how they would solve the problem.

GROUP DISCUSSION**TIPS FOR ANSWERING/FACILITATING DISCUSSION**

- Establish ground rules for discussion, e.g. everyone should listen respectfully; don't interrupt; only one person speaks at a time; no one's ideas should be made fun of; you can disagree with ideas but not with the person; try to understand others as much as you hope they understand you; etc.
- Sit the group in a circle, making sure all cadets can be seen by everyone else.
- Ask questions that will provoke thought; in other words avoid questions with yes or no answers.
- Manage time by ensuring the cadets stay on topic.
- Listen and respond in a way that indicates you have heard and understood the cadet. This can be done by paraphrasing their ideas.
- Give the cadets time to respond to your questions.
- Ensure every cadet has an opportunity to participate. One option is to go around the group and have each cadet answer the question with a short answer.
- Cadets must also have the option to pass if they wish.
- Additional questions should be prepared ahead of time.

SUGGESTED QUESTIONS

- Q1. What is the problem?
- Q2. What is the critical factor?
- Q3. What alternate solutions were developed?
- Q4. List some comparisons for alternate solutions.
- Q5. What solution was chosen?

- Q6. Why was this choice made?
- Q7. What was the plan to implement the solution?
- Q8. What questions would be asked to evaluate the plan and the implementation?



Other questions and answers will develop throughout the group discussion. The group discussion should not be limited to only those suggested.

END OF LESSON CONFIRMATION

The cadets' participation in TP2 and TP3 will serve as the confirmation of this lesson.

CONCLUSION

HOMEWORK/READING/PRACTICE

N/A.

METHOD OF EVALUATION

N/A.

CLOSING STATEMENT

It is important to practice the skill of problem solving in a peer environment. Learning to solve problems is a quality of leadership. Knowing and using a technique to solve problems may help develop problem-solving skills.

INSTRUCTOR NOTES/REMARKS

N/A.

REFERENCES

A2-036 A-CR-CCP-121/PT-001 D Cdts 3. (2003). *Royal Canadian Army Cadet Reference Book*. Ottawa, ON: Department of National Defence.

C0-115 (ISBN 0-7879-4059-3) Van Linden, J. A. & Fertman, C. I. (1998). *Youth Leadership*. San Francisco, California: Jossey-Bass Inc.

C0-135 (ISBN 0-7645-5176-0) Loeb, M. & Kindel, S. (1999). *Leadership for Dummies*. Indianapolis, Indiana: Wiley Publishing, Inc.

PROBLEM SOLVING SCENARIO

In recently studying about the environment, cadets decide to initiate the creation of a recycling program at the corps.

1. **Confirm the task** – (what must you do?)

2. **Identify the problem** – (what is the problem?)

3. **Determine the Critical Factor** – (what is the overriding problem?)

4. **Develop alternate solutions** – (different ways to solve the problem)

1)

2)

3)

5. **Compare alternatives** – (simplest, safest, most flexible, best use of resources, best solution to the critical factor)

Solutions	Answer Questions

6. **Determine the best solution** – (make a choice)

7. **Implement the solution** – (develop a plan to get the problem solved)

8. **Evaluate the plan and the implementation** – (list some questions to ask for evaluation)



COMMON TRAINING INSTRUCTIONAL GUIDE



SECTION 7

EO M203.07 – DISCUSS PERSONAL INTEGRITY AS A QUALITY OF LEADERSHIP

Total Time:

30 min

PREPARATION

PRE-LESSON INSTRUCTIONS

Resources needed for the delivery of this lesson are listed in the lesson specification located in A-CR-CCP-702/PG-001, Chapter 4. Specific uses for said resources are identified throughout the Instructional Guide within the TP for which they are required.

Review the lesson content and become familiar with the material prior to delivering the lesson.

PRE-LESSON ASSIGNMENT

N/A.

APPROACH

An interactive lecture was chosen for TP1 to orient the cadets to personal integrity as a quality of leadership.

An in-class activity was chosen for TP2 and TP3 as an interactive way to provoke thought, stimulate an interest among cadets and present personal integrity as a quality of leadership.

INTRODUCTION

REVIEW

N/A.

OBJECTIVES

By the end of this lesson the cadet shall be expected to discuss personal integrity as a quality of leadership.

IMPORTANCE

It is important for cadets to learn that personal integrity is a fundamental quality of leadership. Without personal integrity, a leader may never build the trust of his followers or his teammates. As listed in CATO 11-03, *Cadet Program Mandate*, leadership is one of the three aims of the Cadet Program.


Teaching Point 1

Explain Personal Integrity

Time: 5 min

Method: Interactive Lecture

The most basic quality of leadership is personal integrity.



Ask cadets if they know what the word integrity means.

Integrity means moral uprightness; honesty. Personal integrity means doing the right thing, even if nobody is watching.


People struggle daily with situations that demand decisions between what they want to do and what they ought to do.

According to John C. Maxwell, the author of a number of best-selling books on leadership, if a leader uses personal integrity, a leader should be consistent. If what the leader says and what the leader does is the same, the results by the team will be consistent. For example:

The leader says to their team: "Be on time."	The leader arrives on time.	The team will be on time.
The leader says to their team: "Be positive."	The leader exhibits a positive attitude.	The team will be positive.
The leader says to their team: "Put others first."	The leader puts others first.	The team puts others first.

If what the leader says and what the leader does is not the same, the results by the team will be inconsistent.

The leader says to their team: "Be on time."	The leader arrives late regularly.	Some of the team will be on time, some will not.
The leader says to their team: "Be positive."	The leader exhibits a negative attitude regularly.	Some of the team will be positive, some will not.
The leader says to their team: "Put others first."	The leader puts themselves first.	Some of the team will put others first, some will not.



Aristotle, the Greek philosopher, once said, "We are what we repeatedly do. Excellence, then, is not an act but a habit."

Personal integrity builds trust. To earn the trust of others, a leader should lead by example. If the leader's words and actions match, teammates and followers should have trust and confidence in the group. Personal integrity usually results in a solid reputation, not just an image.



Personal integrity builds trust. Trust builds confidence. Confidence builds relationships. Relationships build leadership.



For the next series of questions, ensure cadets do NOT name the people they are thinking about. This is NOT a sharing activity.



Ask cadets to think of someone they know who has a good reputation. Is this person trustworthy? Ask cadets to think of someone they know who has poor reputation. Is this person trustworthy?

CONFIRMATION OF TEACHING POINT 1

QUESTIONS

- Q1. What does integrity mean?
- Q2. What is the most basic quality of leadership?
- Q3. What does personal integrity build?

ANTICIPATED ANSWERS

- A1. Integrity means moral uprightness; honesty.
- A2. Personal integrity is the most basic quality of leadership.
- A3. Personal integrity builds trust.

Teaching Point 2

Conduct an Activity Where Cadets Brainstorm Where They Have Seen Integrity Displayed Within Their Peer Group

Time: 5 min

Method: In-Class Activity

ACTIVITY

OBJECTIVE

The objective of this activity is for cadets to brainstorm where they have seen integrity displayed within their peer group. This reflective activity allows cadets to integrate their thoughts about leadership theory into their own experiences.

RESOURCES

N/A.

ACTIVITY LAYOUT

N/A.

ACTIVITY INSTRUCTIONS

Have cadets brainstorm examples where they have seen integrity displayed within their peer group either during cadets, school, or other extra-curricular activities. Write in point form, the examples on a whiteboard/flipchart/OHP.

Discuss instances where the cadets' peers have displayed:

- honesty
- honour,
- good character,
- decency,
- fairness,
- sincerity, and
- trustworthiness, etc.



Ask cadets how they think the person in their example, who displayed personal integrity, would feel if they were in the class at that moment, after all the positive things have been said about them?



If cadets mention someone in the class, be sure to praise the person mentioned. Positive reinforcement of correct behaviour is an excellent instructional technique.

SAFETY

N/A.

CONFIRMATION OF TEACHING POINT 2

The cadets' participation in the activity will serve as the confirmation of this TP.

Teaching Point 3

Conduct an Activity Where Cadets Create a Poster That Shows an Example of Integrity

Time: 15 min

Method: In-Class Activity

ACTIVITY

OBJECTIVE

The objective of this activity is for the cadets to create a poster that shows an example of integrity. This activity allows cadets to reflect on personal integrity as a quality of leadership.

RESOURCES

- Pencil crayons/felt markers, and
- 8.5 x 14 inch paper.

ACTIVITY LAYOUT

N/A.

ACTIVITY INSTRUCTIONS

- Distribute pencil crayons/felt markers and the 8.5 x 14 inch paper to the cadets.
- Have the cadets draw and colour a poster to represent personal integrity as a quality of leadership. Cadets may create a picture, use a mind-map, use a saying, etc. Cadets may use the examples from TP2 or another instance of personal integrity.



Be sure to display posters in a place where they may be seen by as many corps members as possible.

SAFETY

N/A.

CONFIRMATION OF TEACHING POINT 3

The cadets' participation in the activity will serve as the confirmation of this TP.

END OF LESSON CONFIRMATION

The cadets' creation of posters displaying personal integrity will serve as the confirmation of this lesson.

CONCLUSION**HOMEWORK/READING/PRACTICE**

N/A.

METHOD OF EVALUATION

N/A.

CLOSING STATEMENT

Brian Tracy, a leadership trainer, says, "The glue that holds all relationships together, including the relationship between the leader and the led is trust, and trust is based on integrity."

Personal integrity is the foundation of leadership. When cadets display this quality, it is the first step in their role as leaders within a peer setting.

INSTRUCTOR NOTES/REMARKS

N/A.

REFERENCES

A0-010 CATO 11-03 D Cds 2. (2006). *Cadet Program Mandate*. Ottawa, ON: Department of National Defence.

C0-112 (ISBN 0-8407-6744-7) Maxwell, J. C. (1993). *Developing the Leader Within You*. Nashville, Tennessee: Thomas Nelson Inc. Publishers.



COMMON TRAINING INSTRUCTIONAL GUIDE



SECTION 8

EO M203.08 – PARTICIPATE IN TEAM-BUILDING ACTIVITIES

Total Time:

30 min

PREPARATION

PRE-LESSON INSTRUCTIONS

Resources needed for the delivery of this lesson are listed in the lesson specification located in A-CR-CCP-702/PG-001, Chapter 4. Specific uses for said resources are identified throughout the Instructional Guide within the TP for which they are required.

Review the lesson content and become familiar with the material prior to delivering the lesson.

The time spent on each activity is at the discretion of the instructor. One activity may be conducted for the entire period or both activities may be conducted consecutively.

If the group is large, both activities may be conducted concurrently. When conducting activities concurrently, ensure additional supervision is provided.

PRE-LESSON ASSIGNMENT

N/A.

APPROACH

An in-class activity was chosen for this lesson as it is a fun and challenging way to expand the cadets' experience participating in team-building activities and reinforce the cadets' appreciation of the fundamentals of leadership.

INTRODUCTION

REVIEW

N/A.

OBJECTIVES

By the end of this lesson the cadet shall be expected to participate in team-building activities.

IMPORTANCE

It is important for cadets to participate in team-building activities, including trust games, as it may improve their leadership abilities in a peer setting by allowing cadets to practice communication skills and positive group dynamics.

Teaching Point 1**Conduct Team-building Activities Through Trust Games**

Time: 25 min

Method: In-Class Activity

ACTIVITY 1

Time: 10 min

OBJECTIVE

The objective of this activity is to have the cadets develop trust within their peer group.

RESOURCES

N/A.

ACTIVITY LAYOUT

N/A.

ACTIVITY INSTRUCTIONS

1. Divide the group into pairs.
2. Cadets must assume a squatting position.
3. Cadets must face each other with their hands extended in front of their bodies, fingers pointing toward the ceiling and touching palms with their partner.
4. Cadets must attempt to knock their partner off balance by either pushing their palms, or withdrawing their palms using only slow motion movements. (Using slow motion movements should allow the two cadets to become cooperative partners.)
5. A player may lose the game if their feet move. (Most games conveniently end with both partners falling or moving their feet at the same time.)
6. Cadets may change partners as time allows.

SAFETY

The activity will be stopped if horseplay occurs.

ACTIVITY 2

Time: 15 min

OBJECTIVE

The objective of this activity is to have the cadets develop trust in their peer group.

RESOURCES

N/A.

ACTIVITY LAYOUT

N/A.

ACTIVITY INSTRUCTIONS

1. Divide the group into two lines facing each other, forming a corridor.
2. Have cadets put their arms straight in front of themselves. Arms should intersect, overlapping about a hand width apart from the person opposite them.



Figure 1 Slice and Dice

Wilderdorn (2007). Index to Group Activities, Games, Exercises and Initiatives: Trust-Building Activities. (2007). Retrieved 26 April 2007, from <http://wilderdom.com/games/descriptions/SliceNDice.html>

3. The first cadet peels off and walks down the corridor. To let the cadet pass, have the other cadets raise and then lower their arms, creating a ripple effect in the corridor, through which the cadet is walking.
4. Once the cadet is finished walking down the corridor, the cadet joins the end of the corridor from which they have just emerged.
5. The next cadet, at the front of the line, peels off and walks down the corridor, and then joins the end of the line.
6. Each cadet takes a turn going down the corridor.



As cadets become more confident, invite them to walk fast, run and then sprint down the corridor. At some point, have the cadets chop their arms up and down, only pausing to allow the corridor runner through.

SAFETY

The activity will be stopped if horseplay occurs.

CONFIRMATION OF TEACHING POINT 1

The cadets' participation in the team-building activities will serve as the confirmation of this TP.

END OF LESSON CONFIRMATION

The cadets' participation in the team-building activities will serve as the confirmation of this lesson.

CONCLUSION

HOMEWORK/READING/PRACTICE

N/A.

METHOD OF EVALUATION

N/A.

CLOSING STATEMENT

Trust in others and trust in the leader are key leadership attributes and they may assist cadets in leading in a peer setting. When members of a team trust each other, accomplishing any task is usually easier. If cadets cultivate trust and protect the trust that others offer and share, cadets may increase the confidence others have in them and this should increase their own self-confidence.

INSTRUCTOR NOTES/REMARKS

N/A.

REFERENCES

C0-152 Wilderdom. (2007). *Index to Group Activities, Games, Exercises and Initiatives: Trust-Building Activities*. Retrieved 26 April 2007, from <http://wilderdom.com/games/descriptions/SliceNDice.html>.

C1-006 (ISBN 0-8403-5682-X) Ronhke, C. (1984). *Silver Bullets: A Guide to Initiative Problems, adventures Games and Trust Activities*. Dubuque, Iowa: Kendall/Hunt Publishing Company.



COMMON TRAINING INSTRUCTIONAL GUIDE



SECTION 9

EO C203.01 – RECORD ENTRIES IN A REFLECTIVE JOURNAL

Total Time:

3 x 30 min

PREPARATION

PRE-LESSON INSTRUCTIONS

Resources needed for the delivery of this lesson are listed in the lesson specification located in A-CR-CCP-702/PG-001, Chapter 4. Specific uses for said resources are identified throughout the Instructional Guide within the TP for which they are required.

Review the lesson content and become familiar with the material prior to delivering the lesson.

Choose one template of questions for reflection from the four located at Annex A and make a copy for each cadet.

PRE-LESSON ASSIGNMENT

N/A.

APPROACH

An in-class activity was chosen for this lesson to reinforce leadership principles and characteristics and to provoke thought. It also allows the cadets to interact with their peers and share their knowledge, experiences, opinions and feelings about a recent team-building or training activity.

INTRODUCTION

REVIEW

N/A.

OBJECTIVES

By the end of this lesson the cadet shall record entries in a reflective journal.

IMPORTANCE

Reflective thinking and evaluating past performance of tasks through journaling allows cadets to synthesize new knowledge and experiences to prior understanding. Cadets may develop self-awareness and/or recognize positive attributes of leadership that they may wish to integrate into their own personal leadership style.

Teaching Point 1

Conduct an Activity During Which Cadets Record Their Thoughts on Leadership

Time: 25 min

Method: In-Class Activity

Recording in a reflective journal may encourage cadets to evaluate and analyze experiences they have undergone. It is an opportunity to think about, describe and communicate their impressions on peer interactions.

ACTIVITY

OBJECTIVE

The objective of this activity is for cadets to record their thoughts on leadership they displayed or the leadership they observed on a specific training activity.

RESOURCES

- Handouts of questions for reflection,
- 8.5 x 11 inch paper, and
- Pen/pencil.

ACTIVITY LAYOUT

N/A.

ACTIVITY INSTRUCTIONS

1. Distribute a handout of the chosen template for reflection to each cadet.
2. Based on the last training activity in which the cadet participated (e.g., a field exercise, a community service exercise, a tour, etc.) the cadet must reflect on the leadership qualities and attributes they displayed or observed.
3. Instruct cadets to complete the template to the best of their ability.
4. Templates may be completed using sentences or point form. Mind mapping or drawing may be done on a separate piece of paper.



Cadets may share their journal or work with the class.

There are no right or wrong journal entries when cadets record their thoughts. Put as few restrictions as possible on the journal entries cadets may give during this activity.

If time permits, another template of questions for reflection may be completed.

SAFETY

N/A.

END OF LESSON CONFIRMATION

The cadets' participation in the activity will serve as the confirmation of this lesson.

CONCLUSION

HOMEWORK/READING/PRACTICE

N/A.

METHOD OF EVALUATION

N/A.

CLOSING STATEMENT

Recording in a reflective journal, cadets have the opportunity to consider and/or evaluate experiences they have undergone. This may assist them in recognizing leadership qualities, principles and approaches the cadet wishes to incorporate into their own personal leadership style.

INSTRUCTOR NOTES/REMARKS

This EO should follow a significant practical activity such as a tour, a field exercise or EO M203.08 (Participate in Team-Building Activities).

REFERENCES

C0-113 (ISBN 1-882664-12-4) Karnes, F. A. & Bean S. M. (1995). *Leadership for Students: A Practical Guide for Ages 8-18*. Waco, Texas: Prufrock Press.

THIS PAGE INTENTIONALLY LEFT BLANK

TEMPLATE No. 2

Defining Leadership

Based on the last training activity, my definition of leadership is:

Based on the last training activity, my leader's definition of leadership is (what you think your leader would say):

Based on the last training activity, I observed positive leadership when:

TEMPLATE No. 4

Leadership Looks Like/Sounds Like/Feels Like

Based on the last training activity, positive leadership that I observed looked like:

Based on the last training activity, positive leadership that I observed sounded like:

Based on the last training activity, positive leadership that I observed felt like:

Based on the last training activity, attributes I observed and wish to incorporate into my own personal leadership style are:

Based on the last training activity, attributes I wish to avoid incorporating into my own personal leadership style are:



COMMON TRAINING INSTRUCTIONAL GUIDE



SECTION 10

EO C203.02 – EMPLOY PROBLEM SOLVING

Total Time:

60 min

PREPARATION

PRE-LESSON INSTRUCTIONS

Resources needed for the delivery of this lesson are listed in the lesson specification located in A-CR-CCP-702/PG-001, Chapter 4. Specific uses for said resources are identified throughout the Instructional Guide within the TP for which they are required.

Review the lesson content and become familiar with the material prior to delivering the lesson.

Photocopy scenarios located at Annex A.

Cut up scenarios located at Annex A.

PRE-LESSON ASSIGNMENT

N/A.

APPROACH

An in-class activity was chosen for TP1 as an interactive way to provoke thought and stimulate an interest among cadets.

A group discussion was chosen for TP2 as it allows the cadets to interact with their peers and share their knowledge, experiences, opinions and feelings about problem solving.

INTRODUCTION

REVIEW

N/A.

OBJECTIVES

By the end of this lesson the cadet shall employ problem solving.

IMPORTANCE

One of the qualities of leadership is problem solving. As cadets become leaders within a peer setting they will use this quality more often. It is important to practice this quality. Knowing and using a technique to solve problems may give the cadet increased confidence in their leadership ability.

Teaching Point 1

Conduct an Activity Where Cadets Solve Problems Using Logical Analysis

Time: 25 min

Method: In-Class Activity

STEPS TO LOGICAL ANALYSIS

1. **Confirm the Task.** The team must understand both the problem and the aim or intent of the person assigning the task.
 2. **Identify the Problem.** The team must consider the problem and the challenges that may occur in the implementation.
 3. **Determine the Critical Factor.** The critical factor is usually the one overriding problem, on which all other issues depend. The critical factor should be determined by the team.
 4. **Develop Alternate Solutions.** The team should create as many possible solutions to solve the critical factor and other issues as time allows.
 5. **Compare Alternate Solutions.** Each solution must be compared by the team in order to decide on the best solution.
 6. **Determine the Best Solution.** The team should choose the best solution to implement a plan of action.
 7. **Implement the Solution.** The team should create a plan to implement the solution and get the problem solved.
 8. **Evaluate the Plan and Implementation.** The team should evaluate their performance once the problem is solved.
-

ACTIVITY

Time: 15 min

OBJECTIVE

The objective of this activity is for cadets to solve problems within a peer setting.

RESOURCES

- Flipchart paper,
- Markers,
- Paper bag, and
- Scenarios of problems.

ACTIVITY LAYOUT

N/A.

ACTIVITY INSTRUCTIONS

1. Divide the class into small groups of no more than four cadets.
2. Distribute flipchart paper and markers to each group.

3. Have one representative from each group come to the front of the class and pick one or two scenarios at random from a paper bag or a beret.
4. Instruct the cadets that the problem-solving steps must be used to solve the scenario.
5. Cadets must list at least three solutions to each problem.
6. Cadets must record the steps they would use to solve each scenario on the flipchart paper.

SAFETY

N/A.

CONFIRMATION OF TEACHING POINT 1

The cadets' participation in the activity will serve as the confirmation of this TP.

Teaching Point 2

Conduct a Group Discussion Where Cadets Explain Their Choices From the Problem-solving Exercise

Time: 25 min

Method: Group Discussion

BACKGROUND KNOWLEDGE



The point of the group discussion is to draw the following information from the group using the tips for answering/facilitating discussion and the suggested questions provided.

Have one representative from each group present their problem scenario and the steps the group used to solve the problem.

GROUP DISCUSSION



TIPS FOR ANSWERING/FACILITATING DISCUSSION

- Establish ground rules for discussion, e.g., everyone should listen respectfully; don't interrupt; only one person speaks at a time; no one's ideas should be made fun of; you can disagree with ideas but not with the person; try to understand others as much as you hope they understand you; etc.
- Sit the group in a circle, making sure all cadets can be seen by everyone else.
- Ask questions that will provoke thought; in other words avoid questions with yes or no answers.
- Manage time by ensuring the cadets stay on topic.
- Listen and respond in a way that indicates you have heard and understood the cadet. This can be done by paraphrasing their ideas.
- Give the cadets time to respond to your questions.
- Ensure every cadet has an opportunity to participate. One option is to go around the group and have each cadet answer the question with a short answer. Cadets must also have the option to pass if they wish.
- Additional questions should be prepared ahead of time.

SUGGESTED QUESTIONS

- Q1. What is the problem?
- Q2. What is the critical factor?
- Q3. What alternate solutions were developed?
- Q4. What are some comparisons for alternate solutions?
- Q5. What solution was chosen?
- Q6. Why was this choice made?
- Q7. What was the plan to implement the solution?
- Q8. What questions would be asked to evaluate the plan and the implementation?
- Q9. Are there different problems, other solutions, etc.?



Other questions and answers will develop throughout the group discussion. The group discussion should not be limited to only those suggested.



Reinforce those answers given and comments made during the group discussion, ensuring the teaching point has been covered.

CONFIRMATION OF TEACHING POINT 2

The cadets' participation in the group discussion will serve as confirmation of this TP.

END OF LESSON CONFIRMATION

QUESTIONS

- Q1. List the steps in Logical Analysis.
- Q2. What is the critical factor?
- Q3. Who should determine the best solution?

ANTICIPATED ANSWERS

- A1. The steps in Logical Analysis are:
1. confirm the task;
 2. identify the problem;
 3. determine the critical factor;
 4. develop alternate solutions;
 5. compare alternate solutions;
 6. determine the best solution;
 7. implement the solution; and
 8. evaluate the plan and implementation.
- A2. The critical factor is usually the one overriding problem on which all other issues depend.
- A3. The team should determine the best solution.

CONCLUSION

HOMEWORK/READING/PRACTICE

N/A.

METHOD OF EVALUATION

N/A.

CLOSING STATEMENT

Applying the steps in logical analysis to a given problem enables the cadet to determine and implement a solution. With practice, this problem-solving skill will develop. Knowing and using logical analysis to solve problems may give the cadet increased confidence in their ability to lead in a peer setting.

INSTRUCTOR NOTES/REMARKS

N/A.

REFERENCES

A2-036 A-CR-CCP-121/PT-001 D Cdts 3. (2003). *Royal Canadian Army Cadet Reference Book*. Ottawa, ON: Department of National Defence.

C0-115 (ISBN 0-7879-4059-3) Van Linden, J. A. & Fertman, C. I. (1998). *Youth Leadership*. San Francisco, California: Jossey-Bass Inc.

C0-135 (ISBN 0-7645-5176-0) Loeb, M. & Kindel, S. (1999). *Leadership for Dummies*. Indianapolis, Indiana: Wiley Publishing, Inc.

SCENARIOS

Scenario No. 1

You and five other Red Star cadets are tasked to set up a classroom for a class that will begin in ten minutes. You arrive to find the door to your classroom locked. The officer who is supposed to have the key is nowhere to be found.

Scenario No. 2

Your Training Officer is preparing for a weekend exercise and asks you to inventory and restock the three field first aid kits with the help of five cadets.

Scenario No. 3

While on a canteen break, you and other cadets see your best friend take some money that belongs to another cadet.

Scenario No. 4

You enter your corps building with four other cadets to find two male Privates (Pte) in a verbal and physical altercation.

Scenario No. 5

You are told by the Master Warrant Officer (MWO) that the large classroom was not set up properly for the guest speaker who is arriving in 10 minutes. You and three other cadets are told to make sure the classroom is ready on time.

Scenario No. 6

Your corps is holding a mandatory training exercise on the same day as your soccer team is scheduled to play in the regional playoffs. You and three other cadets from your corps play on the same team. Your soccer coach is counting on you to be at the game.

Scenario No. 7

Your Warrant Officer (WO) and Platoon Commander are both absent from the parade night. You and one other cadet are tasked by the Administration Officer to verify the attendance and have your platoon members sign the attendance sheet.

Scenario No. 8

You and five of your friends notice that the parade square needs to be cleaned. Your team accepts this small challenge and have decided to ensure that the parade square is clean for the parade practice for the next period.

THIS PAGE INTENTIONALLY LEFT BLANK



COMMON TRAINING INSTRUCTIONAL GUIDE



SECTION 11

EO C203.03 – DISCUSS CHARACTERISTICS OF A LEADER

Total Time:

60 min

PREPARATION

PRE-LESSON INSTRUCTIONS

Resources needed for the delivery of this lesson are listed in the lesson specification located in A-CR-CCP-702/PG-001, Chapter 4. Specific uses for said resources are identified throughout the Instructional Guide within the TP for which they are required.

Review the lesson content and become familiar with the material prior to delivering the lesson.

Copy the handouts located at Annex A and distribute to each cadet prior to the lesson.

PRE-LESSON ASSIGNMENT

Using the research information sheet provided, the cadets will research a leader of their choice (a military person, political leader, pastor, teacher, etc.) prior to the lesson.

Cadets will bring to the class presentation materials (if needed) and information about the leader they researched.

APPROACH

An in-class activity was chosen for TP1 to reinforce leadership principles to provoke thought.

A group discussion was chosen for TP2 as it allows the cadets to interact with their peers and share their knowledge, experiences, opinions and feelings about characteristics of a leader.

INTRODUCTION

REVIEW

N/A.

OBJECTIVES

By the end of this lesson the cadet shall discuss the characteristics of a leader.

IMPORTANCE

In discussing the characteristics of various leaders, cadets may be able to discern different leadership qualities, principles and approaches. After reflection, cadets may wish to incorporate these qualities, principles and approaches into their own leadership style.

Teaching Point 1**Discuss the Study of Specific Leaders**

Time: 30 min

Method: In-Class Activity

ACTIVITY**OBJECTIVE**

The objective of this activity is to have cadets discuss, in a group of no more than four, their studies of specific leaders.

RESOURCES

N/A.

ACTIVITY LAYOUT

N/A.

ACTIVITY INSTRUCTIONS

1. Divide the class into groups of no more than four.
2. In a group of four, the first cadet will present their study of a specific leader.
3. The other three cadets will be given three minutes to ask questions.



Questions from cadets to the presenter should be created using the research template at Annex A.

4. Another cadet will present their study of a specific leader.
5. The other three cadets will be given three minutes to ask questions.
6. The rest of the cadets will present their specific leader in turn.

SAFETY

N/A.

CONFIRMATION OF TEACHING POINT 1

The cadets' participation in the activity will serve as the confirmation of this TP.

Teaching Point 2**Conduct a Group Discussion Where Cadets Volunteer to Share Their Study of a Specific Leader With the Entire Group**

Time: 20 min

Method: Group Discussion

BACKGROUND KNOWLEDGE

The point of the group discussion is to draw the following information from the group using the tips for answering/facilitating discussion and the suggested questions provided.



Use the completed handouts from the cadets as the material for the group discussion.

GROUP DISCUSSION**TIPS FOR ANSWERING/FACILITATING DISCUSSION**

- Establish ground rules for discussion, e.g. everyone should listen respectfully; don't interrupt; only one person speaks at a time; no one's ideas should be made fun of; you can disagree with ideas but not with the person; try to understand others as much as you hope they understand you; etc.
- Sit the group in a circle, making sure all cadets can be seen by everyone else.
- Ask questions that will provoke thought; in other words avoid questions with yes or no answers.
- Manage time by ensuring the cadets stay on topic.
- Listen and respond in a way that indicates you have heard and understood the cadet. This can be done by paraphrasing their ideas.
- Give the cadets time to respond to your questions.
- Ensure every cadet has an opportunity to participate. One option is to go around the group and have each cadet answer the question with a short answer. Cadets must also have the option to pass if they wish.
- Additional questions should be prepared ahead of time.



Ask cadets if they wish to volunteer to share their study of a specific leader with the class.

SUGGESTED QUESTIONS

- Q1. Where did the leader use their influence?
- Q2. Was the leader's influence positive or negative?
- Q3. How was it positive or negative?
- Q4. How did their leadership style create opportunities in the leader's life?
- Q5. What kind of leadership approach did the leader use?
- Q6. Was the leader able to solve problems?
- Q7. How did the leader solve problems?
- Q8. When did the leader display personal integrity?
- Q9. How did the leader display personal integrity?



Other questions and answers will develop throughout the group discussion. The group discussion should not be limited to only those suggested.



Reinforce those answers given and comments made during the group discussion, ensuring the teaching point has been covered.

CONFIRMATION OF TEACHING POINT 2

The cadets' participation in the group discussion will serve as confirmation of this TP.

END OF LESSON CONFIRMATION

The cadets' participation in the in-class activity and group discussion will serve as the confirmation of this lesson.

CONCLUSION

HOMEWORK/READING/PRACTICE

N/A.

METHOD OF EVALUATION

N/A.

CLOSING STATEMENT

Learning about different leaders and being able to describe their attributes may help cadets understand that leaders come from all walks of life with different leadership qualities, principles and approaches. Deciding

whether to incorporate those attributes into the cadet's leadership style may assist the cadet in becoming a more effective leader.

INSTRUCTOR NOTES/REMARKS

N/A.

REFERENCES

C0-113 (ISBN 1-882664-12-4) Karnes, F. A. & Bean S. M. (1995). *Leadership for Students: A Practical Guide for Ages 8-18*. Waco, Texas: Prufrock Press.

THIS PAGE INTENTIONALLY LEFT BLANK

INFORMATION TO RESEARCH

Name (in Full): _____

Date of Birth: _____

Place of Birth: _____

Date of Death (if Deceased): _____

If Deceased, How Did They Die? _____

Information on Their Childhood: _____

Positions of Responsibility (if Applicable): _____

Incidents Where Influence Was Displayed: _____

Other Interesting Facts or Information: _____

Why Did You Pick This Person? _____

Where Did You Get Your Information? _____



**COMMON TRAINING
INSTRUCTIONAL GUIDE**



SECTION 12

EO C203.04 – PARTICIPATE IN A PRESENTATION GIVEN BY A LEADER

Total Time:

60 min

There is no instructional guide provided for this EO.

THIS PAGE INTENTIONALLY LEFT BLANK



COMMON TRAINING INSTRUCTIONAL GUIDE



SECTION 13

EO C203.05 – PARTICIPATE IN TRUST-BUILDING ACTIVITIES

Total Time:	30 min
-------------	--------

PREPARATION

PRE-LESSON INSTRUCTIONS

Resources needed for the delivery of this lesson are listed in the lesson specification located in A-CR-CCP-702/PG-001, Chapter 4. Specific uses for said resources are identified throughout the Instructional Guide within the TP for which they are required.

Review the lesson content and become familiar with the material prior to delivering the lesson.

The time spent on each activity is at the discretion of the instructor. If time permits, activities may be conducted consecutively. If the group is large, activities may be conducted concurrently. When conducting activities concurrently, ensure enough resources and supervision are available.

PRE-LESSON ASSIGNMENT

N/A.

APPROACH

An experiential approach was chosen for this lesson as it allows the cadets to acquire new skills through a direct experience. This approach allows cadets to experience trust-building activities and define that experience on a personal level. They will be given the opportunity to reflect on and examine what they saw, felt and thought while they were having the experience, and consider how this will relate to future experiences.

INTRODUCTION

REVIEW

N/A.

OBJECTIVES

By the end of this lesson the cadet shall be expected to participate in trust-building activities.

IMPORTANCE

It is important for cadets to participate in trust-building activities as it may improve their leadership abilities in a peer setting by allowing cadets to practice communication skills and positive group dynamics.

BACKGROUND KNOWLEDGE

Trust is a powerful and essential leadership attribute because it is a key to personal involvement. A cadet will seldom take a physical or emotional chance if they perceive callousness or an unreasonable risk. A group surrounded with positive experiences and successes will undergo growth in trust and personal confidence. Trust, within the framework of leadership, is gained with patience, thoughtfulness and care over a period of time. Trust can also be lost in a second by carelessness or inconsiderate behaviour. Cultivating and protecting the trust that another individual offers should be a fundamental leadership quality to be acquired.

ACTIVITY 1

Time: 20 min

Method: Experiential

OBJECTIVE

The objective of this activity is to have cadets develop trust in their peer group.

RESOURCES

- A large empty space with four walls, and
- A blindfold.

ACTIVITY LAYOUT

N/A.

ACTIVITY INSTRUCTIONS



Brief the cadets on any safety rules or any other guidelines pertaining to the activity.

1. Have one cadet stand with their back to one wall of a large four-walled room. This cadet becomes the jogger.
2. The jogger must hold their hands up in front of their body, palms out, to protect themselves.
3. Blindfold the jogger.
4. Place three-quarters of the group in a line with their backs to the wall that the jogger will be approaching. They will act as spotters. The spotter's job is to prevent the jogger from running into the wall.
5. Place the remaining quarter of the group three-quarters of the way down the room to prevent wildly disoriented joggers from running into the side walls.
6. Ask the jogger to jog toward the far wall at a steady, unchanging pace.
7. Have cadets take turns being the jogger.

SAFETY

The spotters must be as quiet as possible to increase the resolve of the jogger.

The spotters must concentrate on the jogger at all times. If the jogger hits a wall the trust of the group may be broken.

ACTIVITY 2

Time: 20 min

OBJECTIVE

The objective of this activity is to have cadets develop trust in their peer group.

RESOURCES

A blindfold.

ACTIVITY LAYOUT

N/A.

ACTIVITY INSTRUCTIONS



Brief the cadets on any safety rules or any other guidelines pertaining to the activity.

1. Divide the group into pairs.
2. Blindfold one cadet. This cadet becomes the walker. The walker must hold their hands up in front of their body, palms out, to protect themselves.
3. The second cadet becomes the talker.
4. The talker must lead the walker on a tour through a pre-determined location in the corps facility.
5. The talker must give directions as simply as possible. (e.g. take two steps forward, turn to your left, take four steps to the right, etc.).
6. The talker is not allowed to touch the walker, unless the walker is about to fall.
7. Have cadets change positions and repeat the activity.

SAFETY

If there are stairs at the corps facility, ensure extra supervision.

REFLECTION

Time: 5 min

GROUP DISCUSSION



TIPS FOR ANSWERING/FACILITATING DISCUSSION

- Establish ground rules for discussion, e.g. everyone should listen respectfully; don't interrupt; only one person speaks at a time; no one's ideas should be made fun of; you can disagree with ideas but not with the person; try to understand others as much as you hope they understand you; etc.
- Sit the group in a circle, making sure all cadets can be seen by everyone else.
- Ask questions that will provoke thought; in other words avoid questions with yes or no answers.
- Manage time by ensuring the cadets stay on topic.
- Listen and respond in a way that indicates you have heard and understood the cadet. This can be done by paraphrasing their ideas.
- Give the cadets time to respond to your questions.
- Ensure every cadet has an opportunity to participate. One option is to go around the group and have each cadet answer the question with a short answer. Cadets must also have the option to pass if they wish.
- Additional questions should be prepared ahead of time.

SUGGESTED QUESTIONS

- Q1. How did it feel to trust others in your group? Why?
- Q2. How did it feel to have others trust you? Why?
- Q3. How does it feel when someone does not trust you?
- Q4. Why is trust an important part of leadership?



Other questions and answers will develop throughout the group discussion. The group discussion should not be limited to only those suggested.

CONCLUSION

REVIEW

Upon completion of the group discussion the instructor will conclude by summarizing the discussion to ensure that all teaching points have been covered. The instructor must also take this opportunity to explain how the cadet will apply this knowledge and/or skill in the future.

TEACHING POINTS

- TP1. Trust is a powerful and essential leadership attribute because it is a key to personal involvement.
- TP2. A group surrounded with positive experiences and successes will undergo growth in trust and personal confidence.
- TP3. Trust can also be lost in a second by carelessness or inconsiderate behaviour.
- TP4. Cultivating and protecting the trust that another individual offers should be a fundamental leadership quality to be acquired.



Reinforce those answers given and comments made during reflection, but ensure that the teaching points have been covered. Any teaching point not brought out during the group discussion shall be covered during review.

HOMEWORK/READING/PRACTICE

N/A.

METHOD OF EVALUATION

N/A.

CLOSING STATEMENT

Trust is a key leadership attribute that may assist cadets in leading in a peer setting. Participating in trust-building activities may assist cadets by increasing the confidence others have in them and this should increase their own self-confidence.

INSTRUCTOR NOTES/REMARKS

N/A.

REFERENCES

C1-006 (ISBN 0-8403-5682-X) Ronhke, C. (1984). *Silver Bullets: A Guide to Initiative Problems, Adventures Games and Trust Activities*. Dubuque, Iowa: Kendall/Hunt Publishing Company.

THIS PAGE INTENTIONALLY LEFT BLANK



COMMON TRAINING INSTRUCTIONAL GUIDE



SECTION 14

EO C203.06 – PARTICIPATE IN PROBLEM-SOLVING ACTIVITIES

Total Time: 30 min

PREPARATION

PRE-LESSON INSTRUCTIONS

Resources needed for the delivery of this lesson are listed in the lesson specification located in A-CR-CCP-702/PG-001, Chapter 4. Specific uses for said resources are identified throughout the Instructional Guide within the TP for which they are required.

Review the lesson content and become familiar with the material prior to delivering the lesson.

The time spent on each activity is at the discretion of the instructor. If time permits, activities may be conducted consecutively. If the group is large, activities may be conducted concurrently. When conducting activities concurrently, ensure enough supervision is available.

PRE-LESSON ASSIGNMENT

N/A.

APPROACH

An experiential approach was chosen for this lesson as it allows the cadets to acquire new skills through a direct experience. This approach allows cadets to experience problem-solving activities and define that experience on a personal level. They will be given the opportunity to reflect on and examine what they saw, felt and thought while they were having the experience, and consider how this will relate to future experiences.

INTRODUCTION

REVIEW

N/A.

OBJECTIVES

By the end of this lesson the cadet shall be expected to participate in problem-solving activities.

IMPORTANCE

It is important for cadets to participate in problem-solving activities as it may improve their leadership abilities in a peer setting by allowing cadets to practice communication skills, positive group dynamics and problem-solving techniques.

BACKGROUND KNOWLEDGE

Problem-solving activities offer a clearly defined opportunity to practice the skill of problem-solving. Each task is designed so that the group must employ communication skills, positive group dynamics and problem-solving techniques. This problem-solving approach to learning can be useful in developing each individual's awareness of their decision making, responsibilities and cooperation with others. Groups engage the problem by taking advantage of the combined physical and mental strengths of each of its members. Problem solving is an unrivalled way to build morale and a sense of camaraderie.

ACTIVITY

Time: 20 min

Method: Experiential

OBJECTIVE

The objective of this activity is to have cadets solve a problem within a peer setting.

RESOURCES

N/A.

ACTIVITY LAYOUT

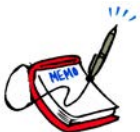
N/A.

ACTIVITY INSTRUCTIONS



Brief the cadets on any safety rules or any other guidelines pertaining to the activity.

1. Divide the cadets into groups of 8 (preferably 4 males and 4 females).



If there is not an even number of males and females, any alternative to identify the two groups may be used (e.g. hats on/hats off, tunics on/tunics off, etc.)

2. The group must solve the problem in the least number of moves. The object of the game is to have all the males end up on one end of the line and all the females on the other end of the line.
3. Have males and females alternate in line.
4. All moves must be made in pairs. Any two cadets standing side by side (without a space between them) may be considered a pair. Pairs may change with each move.
5. As a pair moves, an empty space is created in the line.
6. The empty space may be filled by another pair.

7. Pairs may not pivot or turn around.
8. The final line must have no spaces or gaps.



There are many ways to solve this problem. Have cadets attempt to solve this problem a number of times, trying to minimize the number of moves on each attempt.

The following sequence illustrates the minimum 4 move solution.

1. Move 1 – Pair 2/3 move to the end of the line past 8.

M F M F M F M F
1 (2 3) 4 5 6 7 8

M F M F M F F M
1 4 5 6 7 8 (2 3)

2. Move 2 – Pair 5/6 move into the slot vacated by the previous pair.

M F M F M F F M
1 4 (5 6) 7 8 2 3

M M F F M F F M
1 (5 6) 4 7 8 2 3

3. Move 3 – Pair 8/2 move into the slot vacated by the previous pair.

M M F F M F F M
1 5 6 4 7 (8 2) 3

M M F F F F M M
1 5 6 4 (8 2) 7 3

4. Move 4 – Pair 1/5 move into the slot vacated by the previous pair.

M M F F F F M M
(1 5) 6 4 8 2 7 3

F F F F M M M M
6 4 8 2 7 1 5 3

SAFETY

N/A.

ACTIVITY

Time: 20 min

OBJECTIVE

The objective of this activity is to have the cadets solve a problem within a peer setting.


RESOURCES

- Masking tape, and
- A stopwatch.

ACTIVITY LAYOUT

Using masking tape make a rectangle shape on the floor, 5 m long and 30 cm wide.

ACTIVITY INSTRUCTIONS



Brief the cadets on any safety rules or any other guidelines pertaining to the activity.

1. Divide the cadets into two groups.
2. Each group forms a line inside the rectangle, one behind the other, facing into the centre of the rectangle.



Figure 1 Cadet Shuffle

D Cdts 3, 2007, Ottawa, ON: Department of National Defence

3. Each group must exchange places with the other group without touching the floor outside the rectangle.



Figure 2 Cadet Shuffle

D Cdts 3, 2007, Ottawa, ON: Department of National Defence

4. Time each attempt.
5. For each person that steps outside the rectangle, add 10 seconds to the time.
6. Have cadets attempt this game a number of times, trying to minimize their time on each attempt.

SAFETY

Remind cadets that there is to be no horseplay or pushing other cadets outside the rectangle.

REFLECTION

Time: 5 min

GROUP DISCUSSION



TIPS FOR ANSWERING/FACILITATING DISCUSSION

- Establish ground rules for discussion, e.g. everyone should listen respectfully; don't interrupt; only one person speaks at a time; no one's ideas should be made fun of; you can disagree with ideas but not with the person; try to understand others as much as you hope they understand you; etc.
- Sit the group in a circle, making sure all cadets can be seen by everyone else.
- Ask questions that will provoke thought; in other words avoid questions with yes or no answers.
- Manage time by ensuring the cadets stay on topic.
- Listen and respond in a way that indicates you have heard and understood the cadet. This can be done by paraphrasing their ideas.
- Give the cadets time to respond to your questions.
- Ensure every cadet has an opportunity to participate. One option is to go around the group and have each cadet answer the question with a short answer. Cadets must also have the option to pass if they wish.
- Additional questions should be prepared ahead of time.

SUGGESTED QUESTIONS

- Q1. How did it feel to solve the problem?
- Q2. How could your group have improved on its performance?
- Q3. Did the group follow a problem-solving technique? Why or why not?
- Q4. Did your group members use positive group dynamics when discussing how to solve the problem? Why or why not?



Other questions and answers will develop throughout the group discussion. The group discussion should not be limited to only those suggested.

CONCLUSION

REVIEW

Upon completion of the group discussion the instructor will conclude by summarizing the discussion to ensure that all teaching points have been covered. The instructor must also take this opportunity to explain how the cadet will apply this knowledge and/or skill in the future.

TEACHING POINTS

- TP1. The group must employ communication skills, positive group dynamics and problem-solving techniques.
- TP2. Problem solving develops each individual's awareness of their decision making, responsibilities and cooperation with others.
- TP3. Groups engage the problem by taking advantage of the combined physical and mental strengths of each of its members.
- TP4. Problem solving is an unrivalled way to build morale and a sense of camaraderie.



Reinforce those answers given and comments made during reflection, but ensure that the teaching points have been covered. Any teaching point not brought out during the group discussion shall be covered during review.

HOMEWORK/READING/PRACTICE

N/A.

METHOD OF EVALUATION

N/A.

CLOSING STATEMENT

Problem solving is a key leadership quality. Practicing the skills of problem-solving should assist cadets in leading in a peer setting by increasing their self-confidence. Problem-solving activities allow cadets to practice communication skills, positive group dynamics and problem-solving techniques.

INSTRUCTOR NOTES/REMARKS

N/A.

REFERENCES

C1-006 (ISBN 0-8403-5682-X) Ronhke, C. (1984). *Silver Bullets: A Guide to Initiative Problems, Adventures Games and Trust Activities*. Dubuque, Iowa: Kendall/Hunt Publishing Company.



**COMMON TRAINING
ALL TRAINING LEVELS
INSTRUCTIONAL GUIDE
PERSONAL FITNESS AND HEALTHY LIVING**



SECTION 1

PO X04 – TRACK PARTICIPATION IN PHYSICAL ACTIVITIES

Total Time:

For the following EOs, refer to the lesson specifications located in A-CR-CCP-701/PG-001, *Royal Canadian Army Cadets Green Star Qualification Standard and Plan*:

- CX04.01 – Participate in the Cadet Fitness Assessment and Identify Strategies for Improving Personal Physical Fitness,
- CX04.03 – Participate in a Cooking Class,
- CX04.04 – Attend a Personal Fitness and Healthy Living Presentation, and
- CX04.05 – Attend a Local Amateur Sporting Event.

For the following EOs, refer to the instructional guides located in A-CR-CCP-701/PF-001, *Royal Canadian Army Cadets Green Star Instructional Guides*:

- MX04.01 – Participate in 60 Minutes of Moderate- to Vigorous-Intensity Physical Activity (MVPA) and Track Participation in Physical Activities,
- MX04.02 – Identify Strategies to Improve Participation in Physical Activities and Participate in the Cadet Fitness Assessment,
- MX04.03 – Participate in the Cadet Fitness Assessment and Identify Strategies for Improving Personal Physical Fitness, and
- CX04.02 – Participate in Activities that Reinforce the Three Components of Physical Fitness.

THIS PAGE INTENTIONALLY LEFT BLANK



**COMMON TRAINING
ALL TRAINING LEVELS
INSTRUCTIONAL GUIDE
PHYSICAL ACTIVITIES**



SECTION 1

PO X05 – PARTICIPATE IN PHYSICAL ACTIVITIES

Total Time:

For the following EOs, refer to the instructional guides located in A-CR-CCP-701/PF-001, *Royal Canadian Army Cadets Green Star Instructional Guides*:

- MX05.01 – Participate in Physical Activities,
- CX05.01 – Participate in Physical Activities, and
- CX05.02 – Participate in a Tournament.

THIS PAGE INTENTIONALLY LEFT BLANK



COMMON TRAINING INSTRUCTIONAL GUIDE



SECTION 1

EO M206.01 – PARTICIPATE IN A RECREATIONAL MARKSMANSHIP ACTIVITY

Total Time:

90 min

PREPARATION

PRE-LESSON INSTRUCTIONS

Resources needed for the delivery of this lesson are listed in the lesson specification located in A-CR-CCP-702/PG-001, Chapter 4. Specific uses for said resources are identified throughout the Instructional Guide within the TP for which they are required.

Review the lesson content, unit range standing orders, and become familiar with the material, prior to delivering the lesson. Photocopies of the targets found in the Annexes may be required depending on the activities chosen.

Construct a range IAW A-CR-CCP-177/PT-001, *Canadian Cadet Movement: Cadet Marksmanship Program Reference Manual*.

PRE-LESSON ASSIGNMENT

N/A.

APPROACH

An interactive lecture was chosen for TP1 to present important information about the marksmanship activity.

A practical activity was chosen for TP2 as it is an interactive way to allow cadets to experience recreational marksmanship in a safe and controlled environment. This activity contributes to the development of marksmanship skills and knowledge in a fun and challenging setting.

INTRODUCTION

REVIEW

The review for this lesson will be from EO M106.02 (Carry Out Safety Precautions on the Cadet Air Rifle).

SUGGESTED QUESTIONS

- Q1. Why do we follow safety regulations?
- Q2. How would you verify the safety catch is ON?
- Q3. What are the four “ACTS” of firearm safety?

ANTICIPATED ANSWERS

- A1. We follow safety regulations to prevent accidents with the cadet air rifle.
- A2. When the safety is ON, no red can be seen.
- A3. The mnemonic “ACTS” stands for:
- Assume every firearm is loaded.
 - Control the muzzle direction at all times.
 - Trigger finger must be kept off the trigger and out of the trigger guard.
 - See that the firearm is unloaded (prove it safe).

OBJECTIVES

By the end of this lesson, the cadets shall have participated in a recreational marksmanship activity.

IMPORTANCE

It is important for cadets to participate in a recreational marksmanship activity because it allows them to experience marksmanship in a fun, dynamic, and safe setting.

Teaching Point 1

Conduct a Range Briefing

Time: 10 min

Method: Interactive Lecture



A range briefing is conducted to pass on vital information and answer any questions the cadets may have prior to participating in a marksmanship activity. The range briefing is required to ensure the safe execution of a marksmanship activity.

RANGE BRIEFING

- Explain pertinent sections of the local range standing orders.
- Rules to be observed on all ranges include:
 - proving that rifles are safe prior to being picked up, handed to or received from another person;
 - never pointing rifles at people;
 - inserting safety rods into the barrels of rifles when not in use on the range;
 - never horseplaying on a range;
 - always pointing rifles down range; and
 - following the Range Safety Officer's (RSO) directions and orders at all times.



Review range commands with an explanation and demonstration for each command.
All loading/firing in this TP is to be simulated.

- Review commands used on an air rifle range (as illustrated in Figure 1).

Command	Action To Be Taken
Cover off your firing point	Stand up, move behind the firing point and await further commands.
Place your equipment down and stand back	Lay the equipment down on the mat and stand back when finished.
Adopt the prone position	Adopt the prone position, pick up the rifle, ready the equipment and put on hearing and eye protection.
Type of firing (GRIT)	GRIT is the acronym for: <ul style="list-style-type: none"> • Group (relay); • Range (distance); • Indication (number of rounds); and • Type (grouping, scored).
Relay, load	<ol style="list-style-type: none"> 1. Pick up and hold the rifle with the dominant hand. 2. Ensure the safety catch is in the "ON" position. 3. Pump the rifle, observing a three second pause. 4. Load a pellet (flat end forward). 5. Close the bolt.
Relay, fire	<ol style="list-style-type: none"> 1. Place the safety catch in the "OFF" position. 2. Aim the rifle at the target. 3. Squeeze the trigger. 4. Open the bolt. 5. Repeat the following sequence for each shot: <ol style="list-style-type: none"> a. Pump the rifle, observing a three second pause. b. Load a pellet (flat end forward). c. Close the bolt. d. Aim the rifle at the target. e. Squeeze the trigger. f. Open the bolt. 6. Place the safety in the "ON" position. 7. Partially open the pump lever. 8. Lay down the rifle.

Figure 1 Air Rifle Range Commands

D Cdts 3, 2006, Ottawa, ON: Department of National Defence

- Describe the layout of the air rifle range.
- Review hand-washing procedures on completion of firing. This is important because each time a person handles pellets, a small trace of lead is left on their hands. To decrease the risk of lead poisoning, it is important that all persons wash their hands thoroughly after handling pellets.

CONFIRMATION OF TEACHING POINT 1

QUESTIONS

- Q1. What are two rules used on the range?
- Q2. What is the action for the command “Cover off your firing point”?
- Q3. What does the acronym GRIT stand for?

ANTICIPATED ANSWERS

- A1. General rules observed on a range:
- Rifles must be proved safe prior to being picked up, handed to or received from another person.
 - Never point rifles at people.
 - Insert safety rods into the barrels of rifles when not in use on the range.
 - Never horseplay on a range.
 - Always point rifles down range.
 - Obey the Range Safety Officer’s (RSO) directions and orders at all times.
- A2. The action for the command is stand up, move behind the firing point and await further commands.
- A3. GRIT stands for:
- Group (relay);
 - Range (distance);
 - Indication (number of rounds); and
 - Type (grouping, scored).

Teaching Point 2

Supervise the Cadets’ Participation in a Recreational Marksmanship Activity

Time: 70 min

Method: Practical Activity

ACTIVITY

OBJECTIVE

The objective of this activity is to provide cadets with the opportunity to participate in a recreational marksmanship activity.

RESOURCES

- Cadet air rifle (one per firing lane).
- Cadet air rifle safety rod (one per firing lane).
- Safety glasses/goggles.
- Approved air rifle pellets (.177).
- Target frame.
- Pen/pencil.
- Shooting mat.
- Flags (red and green).



Additional resources required for specific marksmanship activities can be found in the annexes.

ACTIVITY LAYOUT

Construct a range IAW A-CR-CCP-177/PT-001.

ACTIVITY INSTRUCTIONS

- Divide the cadets into relays according to the number of firing lanes.
- Conduct recreational marksmanship activities, choosing from the following categories:
 - classification (see Annex A);
 - fun activities (see Annexes B to E);
 - timed activities (see Annexes F to H); or
 - competitive team/individual activities (see Annexes I and J).



All marksmanship activities in this EO will be conducted in the prone position.

SAFETY

Range activities will be conducted IAW A-CR-CCP-177/PT-001.

CONFIRMATION OF TEACHING POINT 2

The cadets' participation in the activity will serve as the confirmation of this TP.

END OF LESSON CONFIRMATION

The cadets' participation in the activities in TP2 will serve as the confirmation of this lesson.

CONCLUSION

HOMEWORK/READING/PRACTICE

N/A.

METHOD OF EVALUATION

N/A.

CLOSING STATEMENT

Marksmanship is a fun and exciting activity that requires personal discipline and teamwork skills. This activity has also developed into highly competitive levels at the provincial, regional, and national levels.

INSTRUCTOR NOTES/REMARKS

Hand-washing stations must be available for clean-up after the activity is completed.

REFERENCES

A0-027 A-CR-CCP-177/PT-001 D Cdts 3. (2001). *Canadian Cadet Movement: Cadet Marksmanship Program Reference Manual*. Ottawa, ON: Department of National Defence.

A0-041 CATO 14-41 D Cdts 4. (2005). *Marksmanship Classification*. Ottawa ON: Department of National Defence.

C0-103 Free Fever. (ND). *Free Space Shuttle Clip Art*. Retrieved 21 February 2007, from <http://www.freefever.com/freeclipart/spaceshuttle.html>.

C0-109 Eight Planets. (ND). *Moon*. Retrieved 21 February 2007, from <http://luna.eightplanets.net/>.

C0-110 H2O University. (ND). *Moon*. Retrieved 21 February 2007, from http://www.h2ouniversity.org/html/K2_facts_earth.html.

CLASSIFICATION ACTIVITY

CLASSIFICATION ACTIVITY

Objective: To provide cadets the opportunity to obtain marksmanship classifications.

Scoring: There are four classification levels that must meet the following standards:

1. Marksman: Two five-round groupings within a circle of 3 cm in diameter.
2. First Class Marksman: Two five-round groupings within a circle of 2.5 cm in diameter.
3. Expert Marksman: Two five-round groupings within a circle of 2 cm in diameter.
4. Distinguished Marksman: Two five-round groupings within a circle of 1.5 cm in diameter.

Equipment Required:

Mandatory:

- CCT200GRTD Canadian Cadet Movement Air Rifle Grouping Target (one per cadet);
- Air Rifle Grouping Template from A-CR-CCP-177/PT-001 (p. B1-1); and
- A stopwatch.

Optional aids to firing are limited to the following:

- Cadet air rifle sling;
- Marksmanship jacket;
- Shooting glove; or
- Hat.

Activity Guidelines:

1. Distribute an Air Rifle Grouping Target to each cadet.
2. Have cadets write their name and rank on the target and attach it to the target frame.
3. Cadets will fire in relays following the commands given by the RSO.
4. Cadets will fire five pellets into each circle on the target.
5. Give cadets a maximum of 15 minutes to fire.
6. Have cadets retrieve their targets.
7. Score the targets using the Air Rifle Grouping Template.

The following is prohibited:

- Alterations made to the rifles.
- A pellet loading clip.
- Supports used as a rest for the rifle or the forearm.
- A spotting scope.
- Use of sights not provided with the cadet air rifle.
- Coaching.

THIS PAGE INTENTIONALLY LEFT BLANK

FUN ACTIVITY

PYRAMID

Objective: To fire pellets into each point on the pyramid.

Scoring: One point is awarded for each point on the pyramid that is hit by a pellet.

Equipment Required:

Mandatory: Pyramid Target (one per cadet).

Optional aids to firing are limited to the following:

- Cadet air rifle sling;
- Marksmanship jacket;
- Shooting glove; or
- Hat.

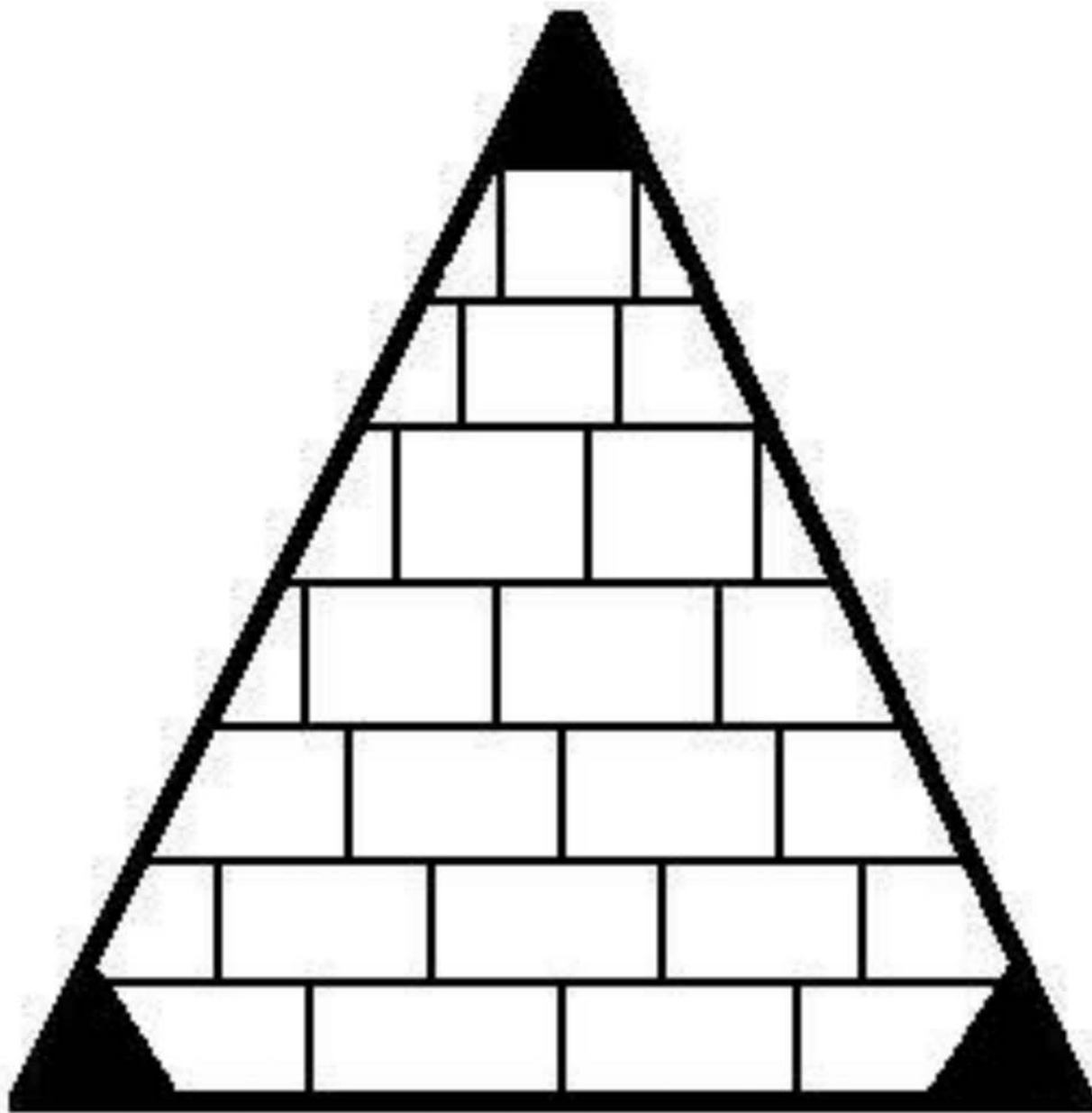
Activity Guidelines:

1. Distribute one Pyramid Target to each cadet.
2. Have cadets write their name and rank on the target and attach it to the target frame.
3. Cadets will fire in relays following the commands given by the RSO.
4. Cadets will be given three pellets to fire one pellet into each corner of the pyramid.
5. Give cadets three minutes to fire.
6. Score the targets awarding one point for each corner hit on the pyramid.
7. On completion of the activity or as time allows, place the targets out for the cadets to review.
8. Return the targets to cadets.

The following is prohibited:

- Alterations made to the rifles.
- A pellet loading clip.
- Supports used as a rest for the rifle or the forearm.
- A spotting scope.
- Use of sights not provided with the cadet air rifle.

PYRAMID TARGET



Name: _____

Date: _____

Figure B-1 Pyramid Target

D Cds 3, 2007, Ottawa, ON: Department of National Defence

FUN ACTIVITY

SHOOTING STAR

Objective: To fire a pellet into each point on the star.

Scoring: One point is awarded for each point on the star that is hit by a pellet.

Equipment Required:

Mandatory: Star Target (one per cadet).

Optional aids to firing are limited to the following:

- Cadet air rifle sling;
- Marksmanship jacket;
- Shooting glove; or
- Hat.

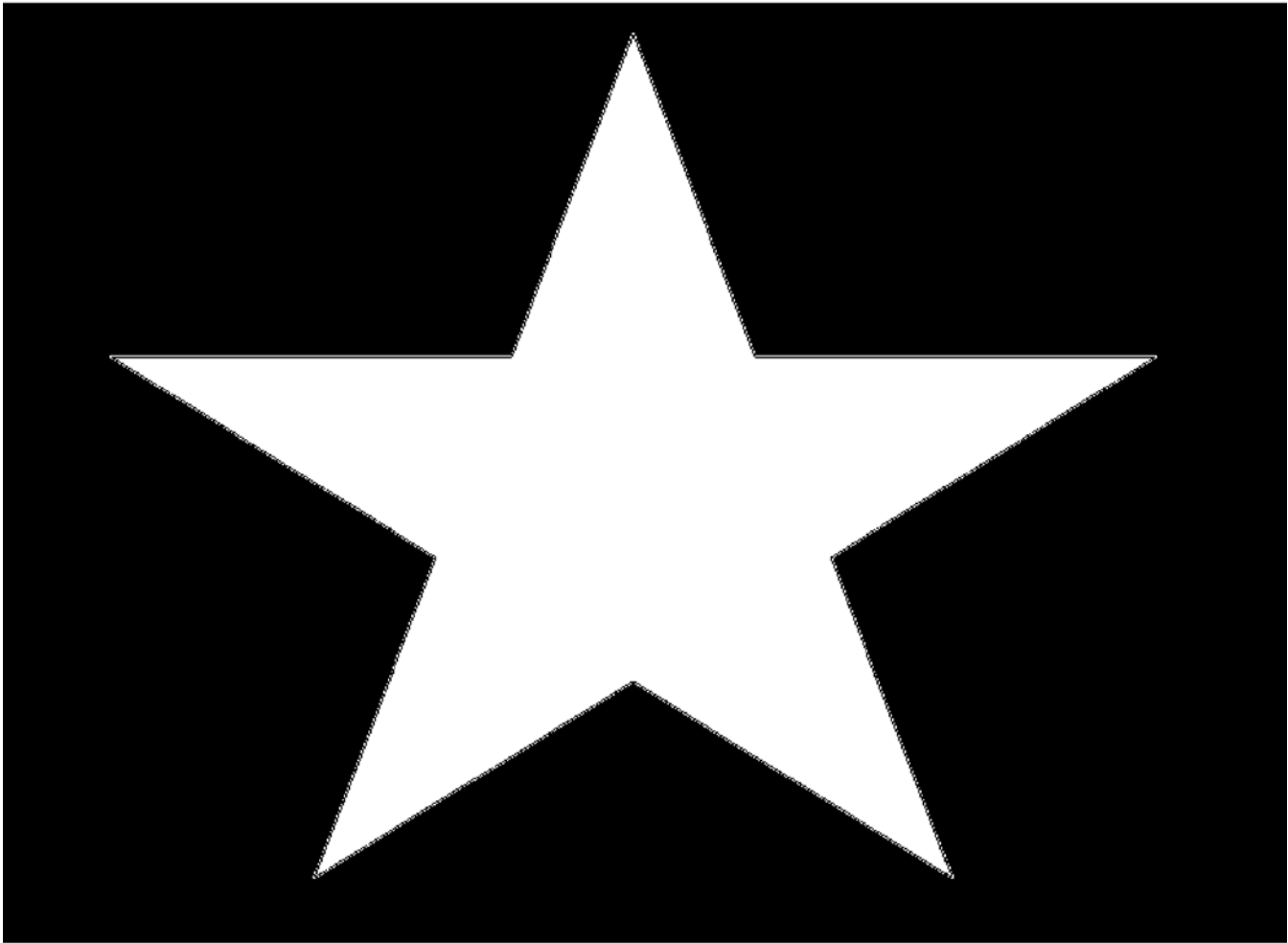
Activity Guidelines:

1. Distribute one Star Target to each cadet.
2. Have cadets write their name and rank on the target and attach it to the target frame.
3. Cadets will fire in relays following the commands given by the RSO.
4. Cadets will be given five pellets to fire one pellet into each point on the star.
5. Give cadets five minutes to fire.
6. Score the targets awarding one point for a pellet hit within each point on the star.
7. On completion of the activity or as time allows, place the targets out for the cadets to review.
8. Return the targets to cadets.

The following is prohibited:

- Alterations made to the rifles.
- A pellet loading clip.
- Supports used as a rest for the rifle or the forearm.
- A spotting scope.
- Use of sights not provided with the cadet air rifle.

STAR TARGET



Name: _____

Date: _____

Figure C-1 Star Target

D Cds 3, 2007, Ottawa, ON: Department of National Defence

FUN ACTIVITY

BEACH BALL

Objective: To fire ten pellets into the black circle on the beach ball.

Scoring: One point is awarded for each successful hit in the black circle.

Equipment Required:

Mandatory: Beach Ball Target (one per cadet).

Optional aids to firing are limited to the following:

- Cadet air rifle sling;
- Marksmanship jacket;
- Shooting glove; or
- Hat.

Activity Guidelines:

1. Distribute one Beach Ball Target to each cadet.
2. Have cadets write their name and rank on the target and attach it to the target frame.
3. Cadets will fire in relays following the commands given by the RSO.
4. Cadets will be given ten pellets to fire into the black circle on the beach ball.
5. Give cadets ten minutes to fire.
6. Score the targets awarding one point for each pellet hit within the black circle.
7. On completion of the activity or as time allows, place the targets out for the cadets to review.
8. Return the targets to cadets.

The following is prohibited:

- Alterations made to the rifles.
- A pellet loading clip.
- Supports used as a rest for the rifle or the forearm.
- A spotting scope.
- Use of sights not provided with the cadet air rifle.

BEACH BALL TARGET



Name: _____

Date: _____

Figure D-1 Beach Ball Target

D Cds 3, 2006, Ottawa, ON: Department of National Defence

FUN ACTIVITY

BALLOONS

Objective: To fire pellets into balloons on the target.

Scoring: One point is awarded for each balloon hit by a pellet.

Equipment Required:

Mandatory: Balloon Target (one per cadet).

Optional aids to firing are limited to the following:

- Cadet air rifle sling;
- Marksmanship jacket;
- Shooting glove; or
- Hat.

Activity Guidelines:

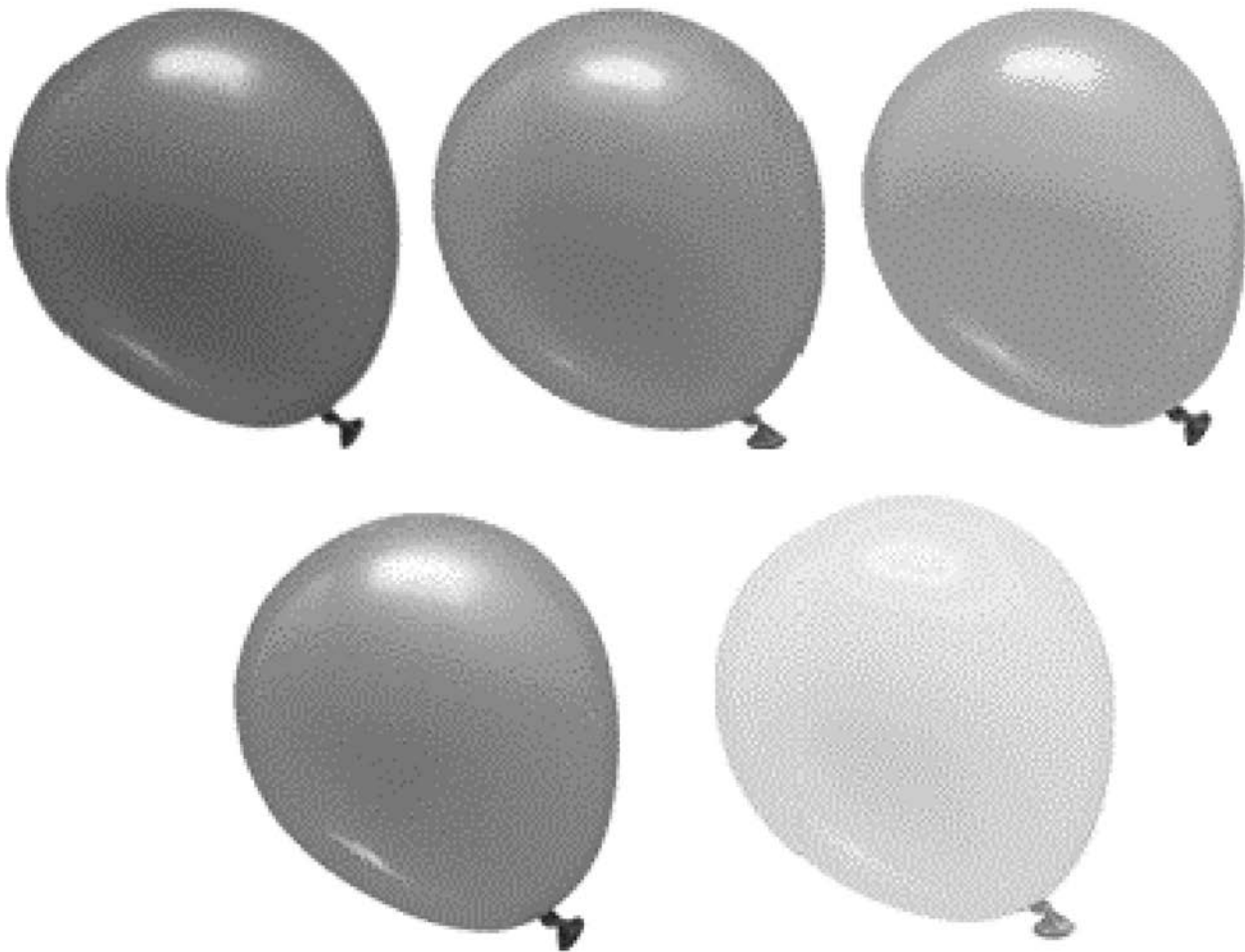
1. Distribute one Balloon Target to each cadet.
2. Have cadets write their name and rank on the target and attach it to the target frame.
3. Cadets will fire in relays following the commands given by the RSO.
4. Cadets will be given five pellets to fire one pellet into each point on the star.
5. Give cadets five minutes to fire.
6. Score the targets awarding one point for each balloon hit.
7. On completion of the activity or as time allows, place the targets out for the cadets to review.
8. Return the targets to cadets.

The following is prohibited:

- Alterations made to the rifles.
- A pellet loading clip.
- Supports used as a rest for the rifle or the forearm.
- A spotting scope.
- Use of sights not provided with the cadet air rifle.

Note: Actual balloons may be used in place of the paper targets.

BALLOON TARGET



Name: _____

Date: _____

Figure E-1 Balloon Target

D Cds 3, 2007, Ottawa, ON: Department of National Defence

TIMED ACTIVITY

CHASE THE DOTS

Objective: To fire pellets into the dots on the target in a clockwise direction, within a time limit.

Scoring: One point is awarded for each black dot that is hit by a pellet within the time allotted.

Equipment Required:

Mandatory:

- Chase the Dots Target (one per cadet); and
- A stopwatch.

Optional aids to firing are limited to the following:

- Cadet air rifle sling;
- Marksmanship jacket;
- Shooting glove; or
- Hat.

Activity Guidelines:

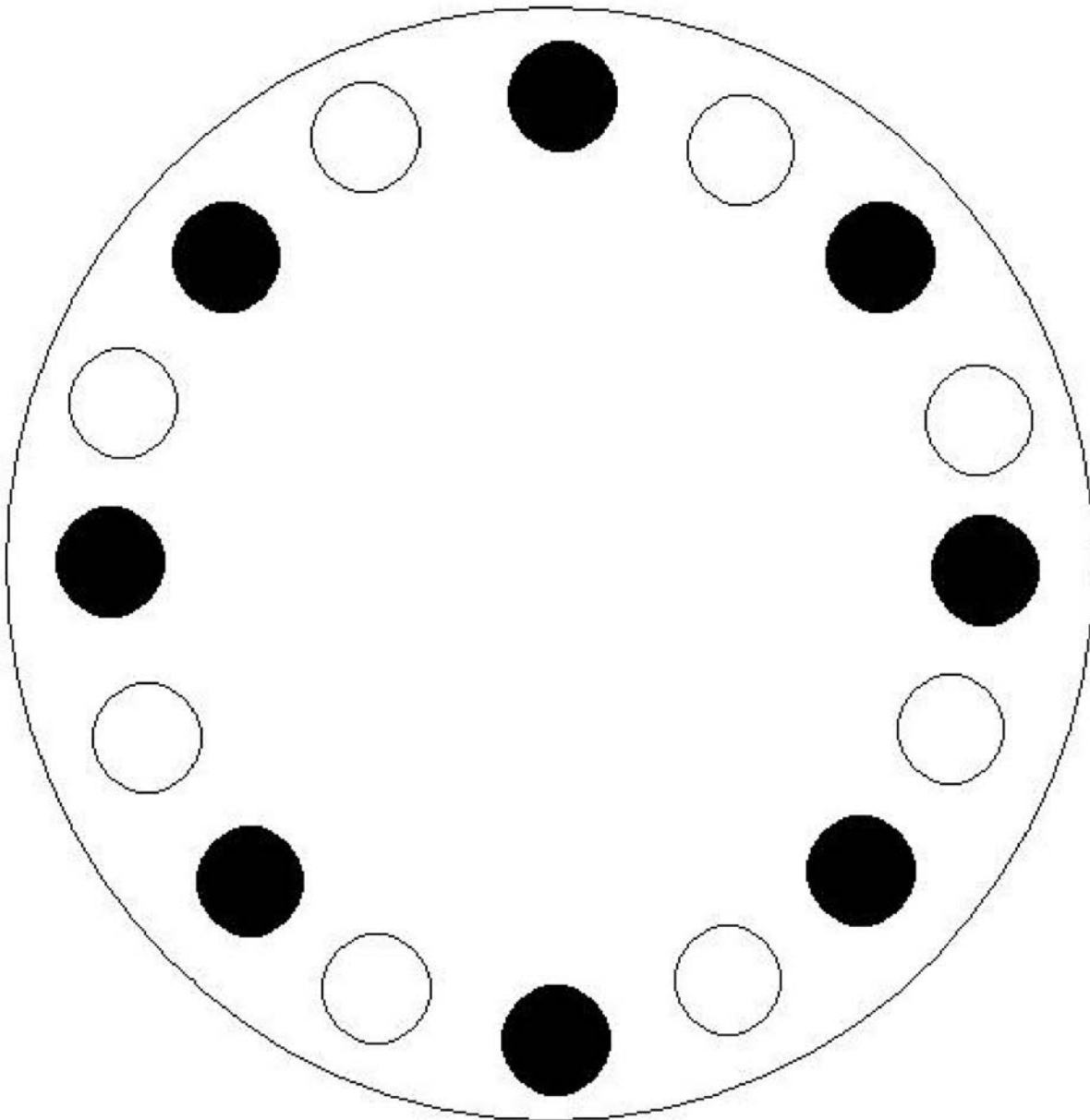
1. Distribute one Chase the Dots Target to each cadet.
2. Have cadets write their name and rank on the target and attach it to the target frame.
3. Cadets will fire in relays following the commands given by the RSO.
4. Cadets will be given sixteen pellets.
5. Cadets will fire one pellet into the black circles, in a clockwise direction, on the target.
6. A suggested time limit for this activity is eight minutes.
7. Have cadets retrieve their targets.
8. Score the targets based on the method described above.
9. On completion of the activity or as time allows, place the targets out for the cadets to review.
10. Return the targets to cadets.

The following is prohibited:

- Alterations made to the rifles.
- A pellet loading clip.
- Supports used as a rest for the rifle or the forearm.
- A spotting scope.
- Use of sights not provided with the cadet air rifle.
- Coaching.

Note: To make this activity more difficult, shorten the time allowance.

CHASE THE DOTS TARGET



Name: _____

Date: _____

Figure F-1 Chase the Dots Target

D Cds 3, 2007, Ottawa, ON: Department of National Defence

TIMED ACTIVITY

SPEED GRID

Objective: To fire pellets into the circles on the target, within a time limit.

Scoring: One point is awarded for each circle that is hit by a pellet within the time allotted.

Equipment Required:

Mandatory:

- Cadet air rifle five pellet clip (three per firing lane);
- Speed Grid Target (one per cadet); and
- A stopwatch.

Optional aids to firing are limited to the following:

- Cadet air rifle sling;
- Marksmanship jacket;
- Shooting glove; or
- Hat.

Activity Guidelines:

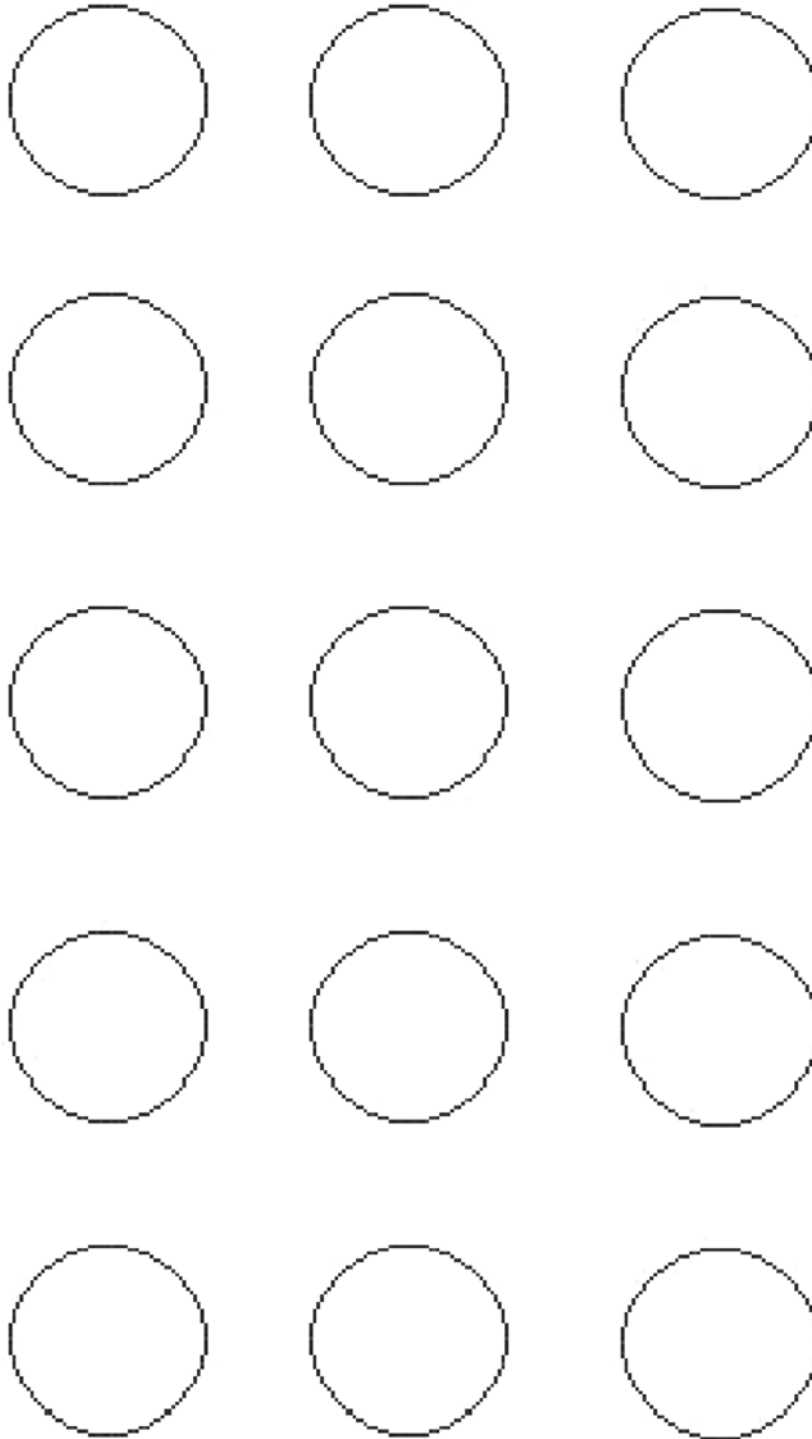
1. Distribute one Speed Grid Target to each cadet.
2. Have cadets write their name and rank on the target and attach it to the target frame.
3. Cadets will fire in relays following the commands given by the RSO.
4. Five pellets will be pre-loaded into the cadet air rifle five pellet clip. Three clips will be used per cadet.
5. Cadets will fire one pellet into each circle on the target.
6. A suggested time limit for this activity is 15 minutes.
7. Have cadets retrieve their targets.
8. Score the targets based on the method described above.
9. On completion of the activity or as time allows, place the targets out for the cadets to review.
10. Return the targets to cadets.

The following is prohibited:

- Alterations made to the rifles.
- Supports used as a rest for the rifle or the forearm.
- A spotting scope.
- Use of sights not provided with the cadet air rifle.
- Coaching.

Note: To make this activity more difficult, shorten the time allowance.

SPEED GRID TARGET



Date: _____

Name: _____

Figure G-1 Speed Grid Target

D Cds 3, 2007, Ottawa, ON: Department of National Defence

TIMED ACTIVITY

BEAT THE CLOCK

Objective: To fire pellets into the designated hours (numbers) within a time limit.

Scoring: One point is awarded for each correct hour (number) hit by a pellet within the time allotted.

Equipment Required:

Mandatory:

- Beat the Clock Target (one per cadet); and
- A stopwatch.

Optional aids to firing are limited to the following:

- Cadet air rifle sling;
- Marksmanship jacket;
- Shooting glove; or
- Hat.

Activity Guidelines:

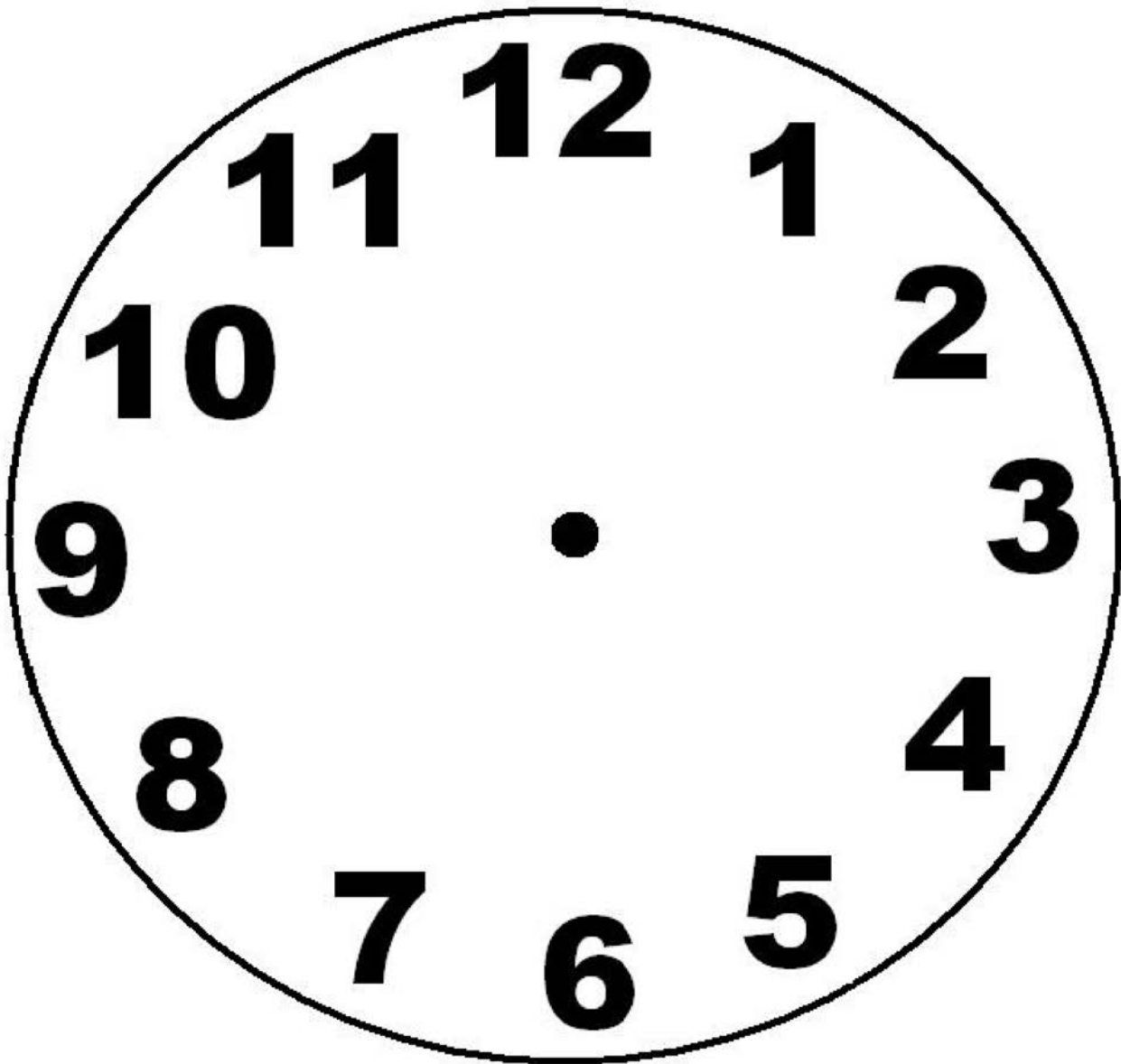
1. Distribute one Beat the Clock Target to each cadet.
2. Have cadets write their name and rank on the target and attach it to the target frame.
3. Cadets will fire in relays following the commands given by the RSO.
4. Cadets will be given six pellets.
5. The RSO will call out six hours (numbers) in five second increments using the 24-hour clock.
6. Cadets will fire one pellet at each hour (number) as it is called by the RSO (e.g. if 1300 hrs was called the cadet will fire at the 1 on the clock face).
7. Have cadets retrieve their targets.
8. Score the targets awarding one point for each correct number hit on the target.
9. On completion of the activity or as time allows, place the targets out for the cadets to review.
10. Return the targets to cadets.

The following is prohibited:

- Alterations made to the rifles.
- Supports used as a rest for the rifle or the forearm.
- A spotting scope.
- Use of sights not provided with the cadet air rifle.
- Coaching.

Note: To make this activity more difficult, shorten the time allowance.

BEAT THE CLOCK TARGET



Name: _____

Date: _____

Figure H-1 Beat the Clock Target

D Cds 3, 2007, Ottawa, ON: Department of National Defence

COMPETITIVE ACTIVITY

CORPS/SQUADRON MARKSMANSHIP COMPETITION

Objective: To provide cadets the opportunity to compete within the corps/squadron.

Scoring: Targets will be scored IAW A-CR-CCP-177/PT-001, to include:

- Each target has a highest possible score of 100 points (10 diagrams worth 10 points each).
- All shot holes are scored using the highest value of the scoring ring that it is touching.
- Shots outside the scoring rings are given a value of zero.
- If more than the prescribed number of shots are fired at a target, the shots with the highest value will be discarded until the correct number of shots remain on the target. A two-point penalty will be deducted for each excess shot.
- If more than one shot is fired at a scoring diagram, only the prescribed number of shots may be fired at the remaining diagrams [e.g., if two shots were fired at the first diagram, one diagram on the target would remain blank (free of shots)]. If this occurs more than twice, a two-point penalty will be deducted for each excess shot.

Equipment Required:

Mandatory: CCT2001AR853 Canadian Cadet Movement Competition Targets (two per cadet).

Optional aids to firing are limited to the following:

- Cadet air rifle sling;
- Marksmanship jacket;
- Shooting glove; or
- Hat.

Activity Guidelines:

1. This activity may be conducted as individuals or teams of four.
2. Distribute two CCT2001AR853 Canadian Cadet Movement Competition Targets to each cadet.
3. Have cadets write their name and rank on the target and attach it to the target frame.
4. Cadets will be given 30 minutes to fire 20 pellets (one pellet at each diagram [zeroing pellets are permitted]).
5. On completion of the activity or as time allows, place the targets out for the cadets to review.
6. After viewing, all targets will be collected by the RSO to record results.
7. Return the targets to cadets.

The following is prohibited:

- Cross-firing.
- Alterations made to the rifles.
- Supports used as a rest for the rifle or the forearm.
- A spotting scope.
- Use of sights not provided with the cadet air rifle.

THIS PAGE INTENTIONALLY LEFT BLANK

COMPETITIVE ACTIVITY

LUNAR LAUNCH

Objective: To provide cadets the opportunity to compete within the corps/squadron.

Scoring: The average distance from the earth to the moon is 384 400 km. All targets from marksmanship activities conducted during the training year will be added together to achieve a distance from earth and position on the space shuttle crew. The four scoring levels/positions must meet the following standards:

1. Mission Commander: A score of 100 or more: 384 400 km from earth, lunar landing!
2. Mission Specialist: A minimum score of 75: 288 300 km from earth.
3. Chief Engineer: A minimum score of 50: 192 200 km from earth.
4. Science Officer: A minimum score of 25: 96 100 km from earth, lunar launch!

Equipment Required:

Mandatory: Any targets used in marksmanship activities during the training year.

Activity Guidelines:

1. Add the scores from the targets used by each cadet during the training year.
2. Use the scoring method described above to assign the cadets levels/positions on the space shuttle crew.

Notes

1. If this activity is conducted, a record must be kept of the cadets' scores from marksmanship activities.
2. This activity may be conducted over multiple training years.
3. The certificate found at Annex J may be awarded to cadets who achieve levels/positions in this activity.



This is to certify that

has achieved the position of

in the



Lunar Launch Marksmanship Activity

Date

Range Safety Officer



COMMON TRAINING INSTRUCTIONAL GUIDE



SECTION 2

EO C206.01 – PRACTICE HOLDING TECHNIQUES

Total Time:

30 min

PREPARATION

PRE-LESSON INSTRUCTIONS

Resources needed for the delivery of this lesson are listed in the lesson specification located in A-CR-CCP-702/PG-001, Chapter 4. Specific uses for said resources are identified throughout the Instructional Guide within the TP for which they are required.

Review the lesson content and become familiar with the material prior to delivering the lesson.

For comfort during this class, it is recommended that cadets be dressed in PT gear.

Ensure all cadet air rifle slings are properly assembled (except one for demonstration).

PRE-LESSON ASSIGNMENT

N/A.

APPROACH

Demonstration was chosen for TP1 and TP2 as it allows the instructor to explain and demonstrate the holding techniques that the cadet is expected to acquire.

Performance was chosen for TP3 as it provides an opportunity for the cadets to practice holding techniques under supervision.

INTRODUCTION

REVIEW

The review for this lesson is from EO M106.03 (Apply Basic Marksmanship Techniques), specifically adopting the prone position.



Have an assistant instructor lie down on a mat and assume the prone position without the cadet air rifle sling. Allow the cadets two minutes to identify and/or correct aspects of the position.

OBJECTIVES

By the end of this lesson the cadet shall have practiced holding techniques.

IMPORTANCE

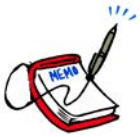
It is important for cadets to practice holding techniques using the cadet air rifle sling, as it will enhance the cadets' marksmanship skills through added stability of the firing position.

Teaching Point 1

Explain and Demonstrate Adopting the Prone Position

Time: 5 min

Method: Demonstration



An assistant instructor may be used to demonstrate as the instructor explains the prone position.

THE PRONE POSITION

The first principle of marksmanship is to find a comfortable firing position. The prone position is the most stable firing position in which the cadet air rifle is supported by the body structure. The prone position requires little movement and muscular tension while holding the cadet air rifle, so that:

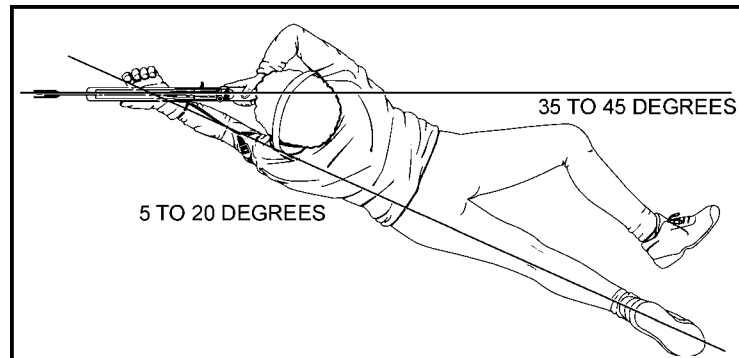


Figure 1 Prone Position
A-CR-CCP-177/PT-001 (p. 1-5-3)

- the bodyweight is equally distributed;
- the position is consistent throughout the relay;
- the body forms a 5 to 20 degree angle to the line of sight with the target;
- the body and spine are straight;
- the left leg is parallel with the spine;
- the right foot is straight out or turned to the right;
- the left foot is straight behind on the toe or pointed to the right; and
- the right knee is brought up so the thigh forms a 30 to 45 degree angle with the left leg.



By bending the right knee, stability is improved. This causes the body to roll slightly, raising the chest off the ground to improve breathing and to minimize body movement caused by a normal heartbeat.

CONFIRMATION OF TEACHING POINT 1

The cadets' participation in the holding technique activity in TP3 will serve as the confirmation of this TP.

Teaching Point 2

Explain and Demonstrate Holding Techniques Using the Cadet Air Rifle Sling

Time: 10 min

Method: Demonstration

The cadet air rifle sling helps the cadet maintain a comfortable and stable position, improving the ability to hold the cadet air rifle. It also allows the right hand to be free to load the air rifle while the rifle remains in position.



Arrange the cadets so they can all hear the explanation and see the demonstration.

ASSEMBLING THE SLING

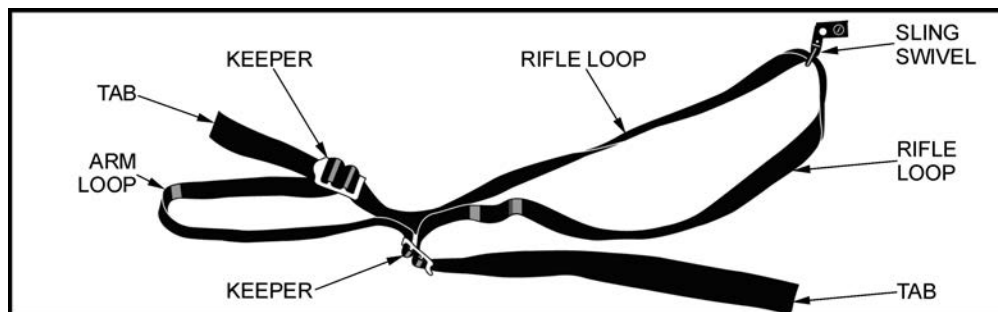


Figure 2 Cadet Air Rifle Sling

A-CR-CCP-121/PT-001, Royal Canadian Army Cadet Reference Book (p. 6-17)

The cadet air rifle sling is assembled in the following sequence:

1. Hold the sling parallel to the ground with the short section in the left hand, ensuring the rounded tip of the keeper is pointing to the left.
2. Take the tab of the short section, loop it through the middle slot of the keeper and then back down through the front slot nearest to the rounded tip. The short section will now form the arm loop.
3. Turn the sling over and slide the sling swivel onto the long section. Ensure the sling swivel hangs downwards, as it will later attach to the rifle.
4. Loop the tab of the long section up through the middle slot of the keeper and then back through the rear slot nearest to the rounded tip. The long section will now form the rifle loop.



An assistant instructor can be used to demonstrate as the instructor explains wearing, adjusting and attaching the cadet air rifle sling.

POSITIONING THE SLING ON THE ARM

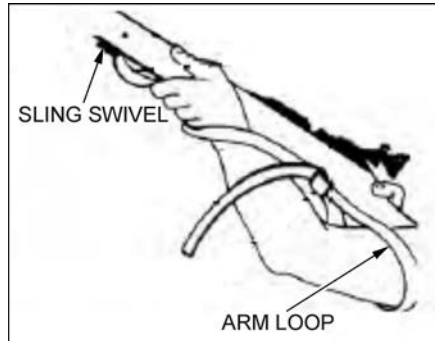


Figure 3 Positioning Sling

Daisy Outdoor Products, Operational Manual – AVANTI Legend EX Model 853C, Daisy Outdoor Products (p. 7)

The sling arm loop should be positioned on the upper part of the arm, above the bicep muscle near the shoulder. The sling can be held in place by the rubber pad on a shooting jacket. When a shooting jacket is not worn, the sling can be kept in place using a safety pin. This will prevent the sling from slipping down the arm while in the prone position.

ADJUSTING THE ARM LOOP

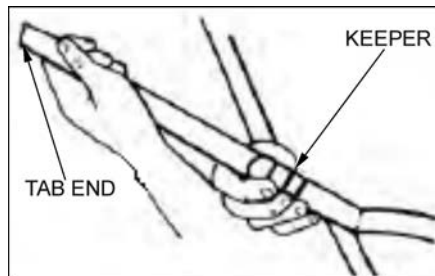


Figure 4 Adjusting Arm Loop

Daisy Outdoor Products, Operational Manual – AVANTI Legend EX Model 853C, Daisy Outdoor Products (p. 8)

To adjust the arm loop, pull the tab away from the keeper. If the sling is too loose, it will not fully support the cadet air rifle and it will have to be kept in place using muscles. If the sling is too tight, it will restrict the blood flow to the arm and can cause discomfort, numbness, or a more pronounced feel of the body's pulse. Therefore, the sling must be comfortable without pinching the arm, while providing maximum support of the cadet air rifle.

ATTACHING THE SLING TO THE CADET AIR RIFLE

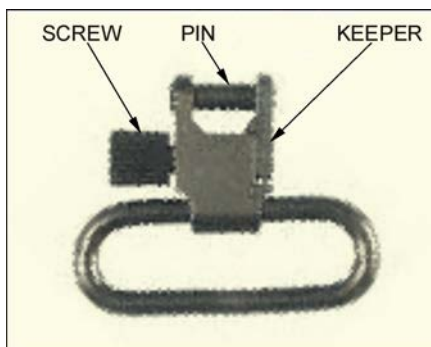


Figure 5 Sling Swivel

D Cdts 3, 2007, Ottawa, ON: Department of National Defence

To attach the sling to the cadet air rifle, simply:

1. open the keeper on the sling swivel by pressing on the screw;
2. insert the swivel pin into the hole of the sling swivel on the fore end of the rifle; and
3. screw the keeper over the pin to lock the swivel in place.

ADJUSTING THE RIFLE LOOP

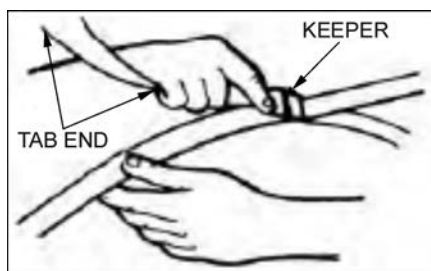


Figure 6 Adjusting Rifle Loop

Daisy Outdoor Products, Operational Manual – AVANTI Legend EX Model 853C, Daisy Outdoor Products (p. 8)

To adjust the rifle loop, pull the tab away from the keeper. The tension of the sling should allow the forearm to be in its proper position. If the sling is too loose, it will not provide maximum support of the cadet air rifle. If the sling is too tight, it could cause discomfort and affect the cadet's position.

CONFIRMATION OF TEACHING POINT 2

The cadets' participation in the holding technique activity in TP3 will serve as the confirmation of this TP.

Teaching Point 3**Conduct a Holding Technique Activity**

Time: 10 min

Method: Performance

ACTIVITY**OBJECTIVE**

The objective of this activity is to have cadets adopt the prone position, positioning the sling on the arm, adjusting the arm loop, attaching the sling to the air rifle, and adjusting the rifle loop.

RESOURCES

- Cadet air rifle (one per firing lane).
- Cadet air rifle sling (one per air rifle).
- Shooting mat (one per firing lane).

ACTIVITY LAYOUT

An air rifle range constructed IAW A-CR-CCP-177/PT-001, Chapter 1, Section 8. If a range is not available, set up the training area to have a defined mock firing point. The assistant instructor shall be used to confirm the cadet's position.

ACTIVITY INSTRUCTIONS

1. Divide cadets into equal groups according to the number of cadet air rifles.
2. Have each group of cadets take turns lying down on mats and assume the prone position.
3. With assistance, allow the cadets to practice the prone position as taught.
4. Have cadets position the sling on the arm and adjust the arm loop.
5. Have cadets attach the sling to the air rifle and put the cadet air rifle into the shoulder.
6. Have cadets adjust the rifle loop of the sling.
7. Have cadets adjust their prone position.
8. Inspect each cadet for proper placement of the sling on the arm and tension of the sling loops.
9. Repeat steps as required, within the allotted time.

SAFETY

Ensure that the cadet air rifles are pointed in a safe direction at all times. Cadets will treat air rifles as though they are loaded.

CONFIRMATION OF TEACHING POINT 3

The cadets' participation in the holding technique activity will serve as the confirmation of this TP.

END OF LESSON CONFIRMATION

The cadets' participation in the holding technique activity in TP3 will serve as the confirmation of this lesson.

CONCLUSION

HOMEWORK/READING/PRACTICE

N/A.

METHOD OF EVALUATION

N/A.

CLOSING STATEMENT

The prone position and the cadet air rifle sling are essential to improving marksmanship techniques. With practice using the sling in the prone position, cadets can improve their technique and their marksmanship score.

INSTRUCTOR NOTES/REMARKS

Instructions may be modified for left-handed cadets (e.g., switching left hand/foot when instructions call for right hand/foot).

This EO is intended to enhance and further develop techniques taught in EO M106.03 (Apply Basic Marksmanship Techniques).

REFERENCES

A0-027 A-CR-CCP-177/PT-001 D Cdts 3. (2001). *Canadian Cadet Movement: Cadet Marksmanship Program Reference Manual*. Ottawa, ON: Department of National Defence.

THIS PAGE INTENTIONALLY LEFT BLANK



COMMON TRAINING INSTRUCTIONAL GUIDE



SECTION 3

EO C206.02 – PRACTICE AIMING TECHNIQUES

Total Time:

60 min

PREPARATION

PRE-LESSON INSTRUCTIONS

Resources needed for the delivery of this lesson are listed in the lesson specification located in A-CR-CCP-702/PG-001, Chapter 4. Specific uses for said resources are identified throughout the Instructional Guide within the TP for which they are required.

Review the lesson content and become familiar with the material prior to delivering the lesson.

PRE-LESSON ASSIGNMENT

N/A.

APPROACH

Demonstration and performance was chosen for TP1 and TP3 as it allows the instructor to explain and demonstrate aiming techniques while providing an opportunity for the cadets to practice these skills under supervision.

An interactive lecture was chosen for TP2 to introduce the aspects of aiming.

INTRODUCTION

REVIEW

Review the following points from EO M106.03 (Apply Basic Marksmanship Techniques).

- The aiming process is achieved by adopting a comfortable prone position and ensuring body alignment with the target.
- Sight alignment is the alignment of the eye, the rear sight, and the front sight.
- The sight picture is obtained by keeping the bull's-eye centred with the circles of the front sight and rear sight.

OBJECTIVES

By the end of this lesson the cadet shall have practiced aiming techniques.

IMPORTANCE

It is important for cadets to practice aiming techniques while wearing the cadet air rifle sling as it will enhance the cadets' marksmanship skills through added stability of the firing position.

Teaching Point 1

Explain, Demonstrate and Have Cadets Practice Proper Eye Usage

Time: 15 min

Method: Demonstration and Performance

Before completing a manual task, it must first be determined which hand or foot to use. Is one left or right-handed? The same is true for sight; it must first be determined the proper eye to use when aiming the cadet air rifle. To do this cadets' must determine their master eye, learn to fire with both eyes open and avoid fixed vision.

DETERMINING THE MASTER EYE

Everyone has a master eye, which is the brain's main source for the visual image of what we see. The non-master eye is used by the brain for depth perception or sense of direction. The master eye is the eye to be used when aiming the cadet air rifle.



The master eye is usually on the same side of the body as the dominate hand. If your master eye is opposite from your dominate hand, you should try firing on the side of your master eye.

ACTIVITY

OBJECTIVE

The objective of this activity is to have the cadets determine their master eye.

RESOURCES

N/A.

ACTIVITY LAYOUT

N/A.

ACTIVITY INSTRUCTIONS

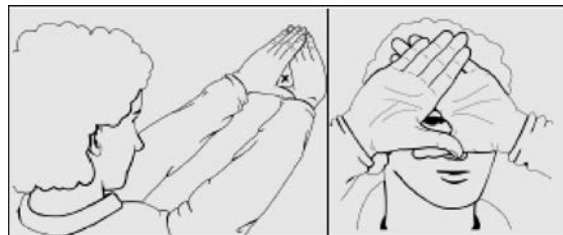


Figure 1 Determining the Master Eye

A-CR-CCP-177/PT-001 (p. 1-5-2)

1. Have cadets stand and face away from each other.
2. Select a small object preferably at least 5 m away.

3. Face the object and extend both arms in front of the face.
4. Form a small triangle opening around the object with both hands.
5. Look through the opening at the object, and draw the hands back towards the face.
6. Ensure the object remains centred through the opening of the hands.
7. Cadets should be looking at the object through the opening with one single eye (the stronger of the two). This is their master eye.

SAFETY

N/A.

FIRING WITH BOTH EYES OPEN

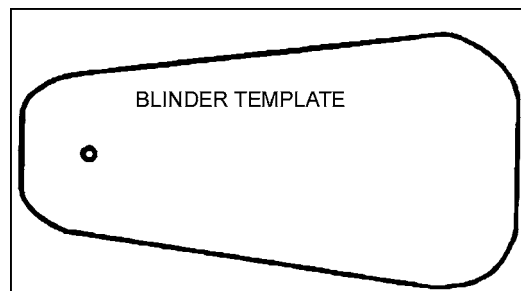


Figure 2 Blinder Template

A-CR-CCP-177/PT-001 (p. 1-5-2)

The human eyes are always working together. If one eye is closed, the opposite eye will strain and affect focusing of the open eye.

Some cadets will have difficulty focusing, so a blinder should be used in front of the non-aiming eye to help prevent squinting and fatigue. The blinder allows the cadets to see a focused sight picture while having both eyes open.

A good blinder should be translucent (plastic or paper) so that images are blocked, but light can still penetrate it. It should be easily attachable to the rear sight or to the cadet's glasses.



Have cadets look at a spot on the wall with both eyes open, then have cadets hold a blank piece of white paper in front of their non-aiming eye. The object should come into a clear focus.

AVOIDING FIXED VISION

When anyone's vision is fixed on one object for more than a few seconds, such as a target bulls-eye, the image can be burned in their mind and a "ghost" image can be seen when glancing to the side. It is important for cadets to avoid this fixed vision during marksmanship training, as it may result in a loss of visual perception and can greatly hinder performance. To avoid fixed vision, cadets need only to blink or slightly shift their vision every four to five seconds.

CONFIRMATION OF TEACHING POINT 1

The cadets' participation in determining the master eye will serve as the confirmation of this TP.

Teaching Point 2**Identify and Explain Aspects of Aiming**

Time: 25 min

Method: Interactive Lecture

Before cadets can aim the cadet air rifle with accuracy, they must first identify aspects of aiming. To do this cadets must understand that the sight system of the cadet air rifle, natural head position, and eye relief all work together when aiming.

SIGHT SYSTEM OF THE CADET AIR RIFLE

The sight system of the cadet air rifle is made up of two main components—the front sight and the rear sight.



Explain to the cadets that the front and rear sights of the cadet air rifle must be used together when acquiring a sight picture.

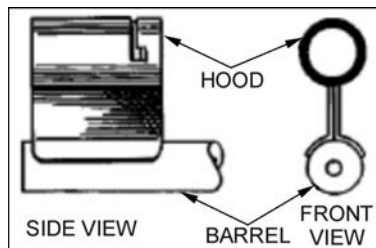


Figure 3 Front Sight

A-CR-CCP-177/PT-001 (p. 1-5-5)

Front Sight. The front sight of the cadet air rifle is made of a short tube, which is called a hood. The hood is designed to shield the front sight from overhead and side light. The most common front sights used for the cadet air rifle is the aperture or circle sight. The aperture is inserted in the hood through a slit on the top.



The adjusting of the sights on the cadet air rifle will be covered in Year Three. Instruct the cadets that they are not to make any adjustments to the sights.

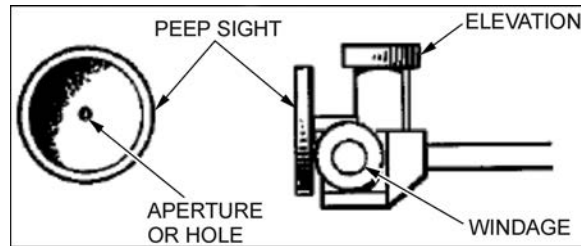


Figure 4 Rear Sight

A-CR-CCP-177/PT-001 (p. 1-5-5)

Rear Sight. The adjustable rear sight of the cadet air rifle has three main parts; peep sight, elevation knob, and windage knob.

- **Peep Sight.** The peep sight is the penny-sized dish-shaped part at the rear of the sight. It has a small hole in the centre to look through.
- **Elevation Knob.** The elevation knob is on the top of the sight and moves the point of impact on the target up or down.
- **Windage Knob.** The windage knob is on the side of the sight and moves the point of impact on the target left or right.

NATURAL HEAD POSITION

The head should be kept as close as possible to a natural position, allowing the eyes to look straight forward from the eye socket. It is perfectly normal to tilt the head forward slightly, but cadets must resist allowing it to tilt to the left or right as this may affect their sense of balance.

EYE RELIEF

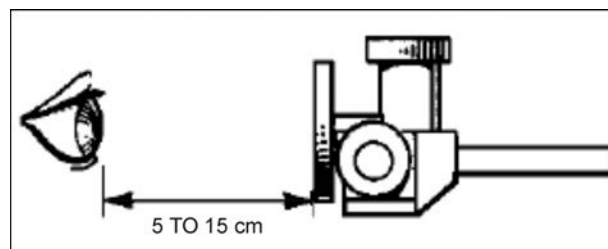


Figure 5 Eye Relief

A-CR-CCP-177/PT-001 (p. 1-5-6)

Eye relief is the distance between the eye and the peep sight on the rear sight. Depending on an individual's build and position, the distance is usually 5 to 15 cm. Eye relief should be comfortable, natural and allow the head to be as erect as possible during the firing process. It is important to maintain the same eye relief from shot to shot and to find an eye relief that allows a circle of light to be seen around the front sight while looking through the rear sight. If the eye relief is less than 5 cm, the line of white around the front sight becomes larger, making the sight picture more difficult to keep aligned.

CONFIRMATION OF TEACHING POINT 2

QUESTIONS

- Q1. What are the two main components of the cadet air rifle sight system?
- Q2. What are the three parts of the rear sight?
- Q3. What is the usual distance for eye relief?

ANTICIPATED ANSWERS

- A1. The front and rear sights.
- A2. The peep sight, elevation knob and windage knob.
- A3. 5 to 15 cm.

Teaching Point 3

Explain, Demonstrate and Have Cadets Practice Marksmanship-related Breathing

Time: 15 min

Method: Demonstration and Performance

Breathing supplies the blood stream with oxygen and eliminates waste elements (such as carbon dioxide) from the blood. While breathing, the oxygen inhaled is used to supply muscles with energy, ensuring optimal potential of the muscles. Just like in sports, controlled breathing can affect marksmanship outcomes.

CONTROLLED BREATHING

Once a stable prone position is established, cadets must integrate the principles of controlled breathing. For maximum stability when firing, cadets will have to hold their breath for five to seven seconds. It is very important that they do not hold their breath for more than seven seconds, as tension will increase in the chest, muscles will lack oxygen and stability will be reduced. When the body lacks oxygen, muscles will quiver and eyesight will be negatively affected.

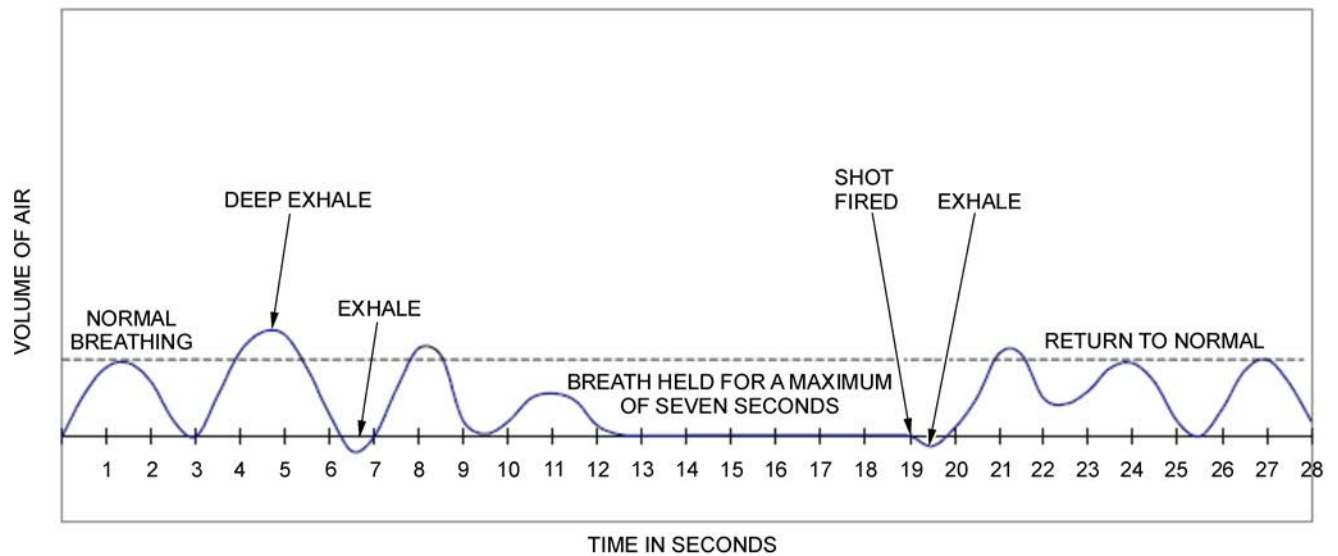


Figure 6 Breathing Cycle
A-CR-CCP-177/PT-001 (p. 1-5-9)

ACHIEVING A CONTROLLED BREATHING SEQUENCE



During the breathing sequence, cadets should confirm that the cadet air rifle is moving up and down and it is not canted. Also, when breathing in and out, cadets can visually confirm that they are aiming on the proper diagram.

ACTIVITY

Time: 10 min

OBJECTIVE

The objective of this activity is to have cadets practice a controlled breathing sequence.

RESOURCES

- Cadet air rifles (one per firing lane).
- Cadet air rifle slings (one per air rifle).
- Cadet air rifle safety rods (one per air rifle).
- Suitable targets (one per firing lane).

ACTIVITY LAYOUT

N/A.

ACTIVITY INSTRUCTIONS

1. Divide the cadets into groups based on the number of air rifles available.
2. Have cadets adopt the prone position using the cadet air rifle sling.

3. Have the cadets relax and breathe normally.
4. Have the cadets obtain a sight picture.
5. Have the cadets inhale and exhale deeply.
6. Have the cadets inhale deeply and exhale normally.
7. Have the cadets relax the chest muscles, hold a breath for 5 to 7 seconds and squeeze the trigger.
8. Have the cadets exhale completely and resume normal breathing.



It is important for cadets not to fire if they feel they want to take another breath. Their shot will not be perfect and their end result will be affected. Relaxed breathing decreases “vibrations” caused by tension.

SAFETY

Ensure control at all times. Cadets will treat air rifles as though they are loaded.

CONFIRMATION OF TEACHING POINT 3

The cadets' participation in the controlled breathing activity will serve as the confirmation of this TP.

END OF LESSON CONFIRMATION

QUESTIONS

- Q1. What is the master eye used for in marksmanship?
- Q2. How much eye relief is between the eye and the rear sight?
- Q3. During a controlled breathing sequence, what direction should the cadet air rifle move?

ANTICIPATED ANSWERS

- A1. To aim the cadet air rifle.
 - A2. 5 to 15 cm.
 - A3. Up and down.
-

CONCLUSION

HOMEWORK/READING/PRACTICE

N/A.

METHOD OF EVALUATION

N/A.

CLOSING STATEMENT

Breathing is essential to marksmanship as it supplies the muscles with oxygen and helps the cadet to maintain the prone position. With practice using the controlled breathing sequence, cadets can improve their aiming of the cadet air rifle and marksmanship scores can improve.

INSTRUCTOR NOTES/REMARKS

N/A.

REFERENCES

A0-027 A-CR-CCP-177/PT-001 D Cdts 3. (2001). *Canadian Cadet Movement: Cadet Marksmanship Program Reference Manual*. Ottawa, ON: Department of National Defence.

THIS PAGE INTENTIONALLY LEFT BLANK



COMMON TRAINING INSTRUCTIONAL GUIDE



SECTION 4

EO C206.03 – PRACTICE FIRING TECHNIQUES

Total Time:

30 min

PREPARATION

PRE-LESSON INSTRUCTIONS

Resources needed for the delivery of this lesson are listed in the lesson specification located in A-CR-CCP-702/PG-001, Chapter 4. Specific uses for said resources are identified throughout the Instructional Guide within the TP for which they are required.

Review the lesson content and become familiar with the material prior to delivering the lesson.

For comfort during this class, it is recommended that cadets be dressed in PT gear.

PRE-LESSON ASSIGNMENT

N/A.

APPROACH

Demonstration and performance was chosen for TP1 as it allows the instructor to explain and demonstrate firing techniques while providing an opportunity for the cadets to practice these skills under supervision.

Demonstration was chosen for TP2 as it allows the instructor to explain and demonstrate trigger control.

An interactive lecture was chosen for TP3 to present basic material on follow-through.

INTRODUCTION

REVIEW

The review for this lesson is from EO M106.03 (Apply Basic Marksmanship Techniques). The sequence required to fire the cadet air rifle when the RSO gives the command “Fire”, will include:

1. place safety catch in the OFF position;
2. aim the cadet air rifle at the target;
3. squeeze the trigger;
4. open the bolt, pump the rifle, reload, aim and fire;
5. repeat the last step until firing is complete;

6. upon completion, place the safety catch in the ON position and partially open the pump lever; and
7. lay down the cadet air rifle.

OBJECTIVES

By the end of this lesson the cadet shall have practiced firing techniques.

IMPORTANCE

It is important for cadets to practice natural alignment, trigger control and follow-through when firing the cadet air rifle, as it helps cadets achieve a stable prone position and sight picture.

Teaching Point 1

Explain, Demonstrate and Have the Cadets Practice Natural Alignment

Time: 15 min

Method: Demonstration and Performance

NATURAL ALIGNMENT



With the use of an assistant instructor, demonstrate and explain natural alignment as listed below, prior to cadets practicing this procedure.

Natural alignment describes the direction that the cadet air rifle is aimed when the marksman is in the prone position with the cadet air rifle at the ready. In a comfortable position, the cadet air rifle should not be forced to point at the target. Even with a perfect prone position and sight alignment, forcing the air rifle can cause muscle tension and will affect the accuracy of each shot.

Natural alignment is obtained by:

1. adopting a comfortable prone position;
2. acquiring a sight picture;
3. closing both eyes;
4. taking several normal breaths to relax the muscles;
5. looking through sights when comfortable;
6. adjusting body position until a proper sight picture is achieved; and
7. proceeding with firing.

ACTIVITY

Time: 10 min

OBJECTIVE

The objective of this activity is to have cadets practice natural alignment.

RESOURCES

- Cadet air rifle (one per firing lane).
- Cadet air rifle safety rod (one per rifle).
- Shooting mat (one per firing lane).
- Suitable target (one per firing lane).

ACTIVITY LAYOUT

Construct an air rifle range IAW A-CR-CCP-177/PT-001, Chapter 1, Section 8. If a range is not available, set up the training area to have a defined mock firing point. Ensure that the air rifles are pointed in a safe direction at all times.

ACTIVITY INSTRUCTIONS

1. Divide cadets into equal groups according to the number of cadet air rifles available.
2. Have cadets lie on the mats and assume the prone position using the cadet air rifle and sling.
3. Cadets will acquire a sight picture by aligning the eye, rear sight, front sight, and the target bull's eye.
4. When cadets have a sight picture, have them close their eyes.
5. Have cadets relax by taking 3 to 4 normal breaths.
6. After approximately 10 seconds, have cadets open their eyes and inspect their sight picture.
7. Cadets shall adjust their bodies to re-acquire an accurate sight picture.
8. Repeat steps 4 to 9, as required, within the allotted time.

SAFETY

Ensure control at all times. Cadets will treat cadet air rifles as though they are loaded.

CONFIRMATION OF TEACHING POINT 1

The cadets' participation in the natural alignment activity will serve as the confirmation of this TP.

Teaching Point 2

Time: 5 min

Demonstrate and Explain Trigger Control

Method: Demonstration

TRIGGER CONTROL



With the use of an assistant instructor, allow the cadets to observe the demonstration and hear the explanation for each aspect of trigger control as listed below.

Trigger control is the handling of the trigger in such a way that there is no disturbance. It must be constant, controlled, slow and deliberate.

Position of the Hand on the Rifle. Cadets should have a relatively firm grip so the three lower fingers wrap around the small of the butt. The thumb is pointed forward in a relaxed position behind the rear sight along the rifle stock, or wrapped around the small of the butt.

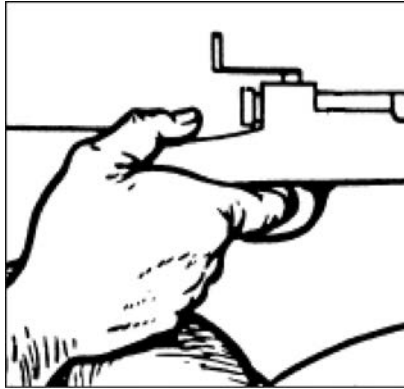


Figure 1 Position of the Hand on the Rifle

D Cdts 5, Royal Canadian Army Cadets Visual Aids Rifle Shooting Figures, Department of National Defence (p. 11)

Trigger Finger Position. The index finger is placed on the trigger halfway between the tip of the finger and the first joint. The index finger never touches the stock of the rifle and must be vertically centred on the trigger.

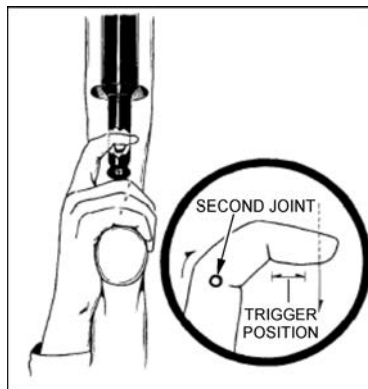


Figure 2 Trigger Finger Position

A-CR-CCP-177/PT-001 (p. 1-5-9)

Squeezing the Trigger. Squeezing the trigger is simply applying pressure to the trigger, by bending the second joint of the index finger straight to the rear. While the breath is being held, apply constant pressure and slowly squeeze the trigger. Trigger pressure is to be applied only when ready to fire.

CONFIRMATION OF TEACHING POINT 2

The cadets' observation of the trigger control demonstration will serve as the confirmation of this TP.

Teaching Point 3**Define Follow-through**

Time: 5 min

Method: Interactive Lecture

FOLLOW-THROUGH

Since no pellets will be fired, position the cadets so they may observe an assistant instructor perform a simulation and hear the explanation of follow-through.

Follow-through is defined as the act of remaining in a stable prone position for two seconds and reacquiring the sight picture after firing the air rifle. Follow-through is critical to ensuring there is no movement as the cadet air rifle is being fired. If the cadet moves the cadet air rifle during firing, the pellet will not hit the target in the spot that it was aimed. Ensuring proper follow-through allows cadets to improve their skills, and their score.

CONFIRMATION OF TEACHING POINT 3**QUESTIONS**

- Q1. How long must a stable position be held after firing the cadet air rifle?
- Q2. What will happen to a pellet during follow-through?
- Q3. If the rifle moves before the pellet leaves the muzzle, how will it affect the target?

ANTICIPATED ANSWERS

- A1. A stable position must be held for two seconds.
- A2. It will leave the muzzle.
- A3. The pellet will not hit the target in the spot that it was aimed.

END OF LESSON CONFIRMATION

The cadets' participation in marksmanship activities using natural alignment, trigger control and follow-through, will serve as the confirmation of this lesson.

CONCLUSION

HOMEWORK/READING/PRACTICE

N/A.

METHOD OF EVALUATION

N/A.

CLOSING STATEMENT

Natural alignment, trigger control and follow-through are essential to developing marksmanship skills. They help cadets maintain a stable position and sight picture when firing the cadet air rifle. With practice using these firing techniques, cadets can improve their skills and their score.

INSTRUCTOR NOTES/REMARKS

N/A.

REFERENCES

A0-027 A-CR-CCP-177/PT-001 D Cdts 3. (2001). *Canadian Cadet Movement: Cadet Marksmanship Program Reference Manual*. Ottawa, ON: Department of National Defence.



ROYAL CANADIAN ARMY CADETS

RED STAR

INSTRUCTIONAL GUIDE



SECTION 1

EO M207.01 – IDENTIFY RED STAR TRAINING OPPORTUNITIES

Total Time:

30 min

PREPARATION

PRE-LESSON INSTRUCTIONS

Resources needed for the delivery of this lesson are listed in the lesson specification located in A-CR-CCP-702/PG-001, Chapter 4. Specific uses for said resources are identified throughout the Instructional Guide within the TP for which they are required.

Review the lesson content and become familiar with the material prior to delivering the lesson.

A handout of the POs and EOs for Red Star training is located in A-CR-CCP-702/PG-001, Chapter 2, Annex A. Photocopy if required.

Obtain the corps full value contract developed during EO M107.01 (Participate in a Discussion on Year One Training). If a full value contract was not developed, instructors may choose one from Annex A to complete with the cadets as an optional activity.

PRE-LESSON ASSIGNMENT

N/A.

APPROACH

An interactive lecture was chosen for this lesson to introduce the cadets to year two training and to generate an interest.

INTRODUCTION

REVIEW

N/A.

OBJECTIVES

By the end of this lesson the cadet shall be expected to identify the training they will receive in Red Star and evaluate individual and group goals.

IMPORTANCE

It is important for cadets to know what training will be conducted during Red Star to give them an overview of what the training year will entail. Red Star will be an exciting year of new experiences. Providing the cadets with a brief overview of the program may create eagerness to complete training. The updates in the cadet corps full value contract should energize the individual cadets and the entire group for the upcoming training year.

Teaching Point 1**Discuss Red Star Mandatory Training**

Time: 5 min

Method: Interactive Lecture

COMMON TRAINING

There is common training which applies to Sea, Army and Air Cadets. POs for training that is common to all cadets in year two include:

PO Number and Topic	PO Statement
201 Citizenship	Identify the Role of an Environmentally Conscious Canadian Citizen
202 Community Service	Perform Community Service
203 Leadership	Demonstrate Leadership Attributes Within a Peer Setting
204 Personal Fitness and Healthy Living	Update Personal Activity Plan
205 Recreational Sports	Participate in Recreational Sports
206 Marksmanship	Fire the Cadet Air Rifle During Recreational Marksmanship
207 General Cadet Knowledge	Serve in an Army Cadet Corps
208 Drill	Execute Drill as a Member of a Squad
211 Summer Biathlon	Participate in Competitive Summer Biathlon Activities

ARMY CADET TRAINING

There is elemental training which is specific to Army Cadets. POs for training that is specific to Army Cadets in year two include:

PO Number and Topic	PO Statement
220 Canadian Forces Familiarization	Recognize Canadian Forces Peace Support Operations
221 Field Training	Perform the Duties of a Section Member During a Weekend Bivouac Exercise
222 Navigation	Navigate Along a Route Using a Map and Compass
223 Trekking	Hike Along a Route as Part of an Overnight Exercise
224 Wilderness Survival	Identify Immediate Actions to Take When Lost

Expedition is one activity that distinguishes Army Cadets from the other cadet elements. According to CATO 41-05, *Royal Canadian Army Cadet Expedition Program*, expedition is defined as any activity that consists of

dynamic travel of no less than 36 hours in duration, where there is a clear goal associated with the activity. In Red Star training, expedition is supported by PO 221 Field Training, PO 222 Navigation, PO 223 Trekking and PO 224 Wilderness Survival.

CONFIRMATION OF TEACHING POINT 1

QUESTIONS

- Q1. What is common training?
- Q2. What are the common training POs?
- Q3. What are the Army specific POs?

ANTICIPATED ANSWERS

- A1. Training that applies to Sea, Army and Air Cadets.
- A2. Common training POs include:
- 201 Citizenship;
 - 202 Community Service;
 - 203 Leadership;
 - 204 Personal Fitness and Healthy Living;
 - 205 Recreational Sports;
 - 206 Marksmanship;
 - 207 General Cadet Knowledge;
 - 208 Drill; and
 - 211 Summer Biathlon.
- A3. Army specific POs include:
- 220 CF Familiarization;
 - 221 Field Training;
 - 222 Navigation;
 - 223 Trekking; and
 - 224 Wilderness Survival.

Teaching Point 2

Discuss Red Star Complementary Training

Time: 5 min

Method: Interactive Lecture



This TP will vary by cadet corps. Discuss the complementary training the cadet corps will pursue throughout the Red Star Program. Refer to the corps annual training plan for complementary training opportunities.

CONFIRMATION OF TEACHING POINT 2

QUESTIONS

- Q1. What complementary training will be completed in the field?
- Q2. What complementary training is available to Sea, Army and Air Cadets?
- Q3. What complementary training is the most interesting?

ANTICIPATED ANSWERS

- A1. Answers will vary.
- A2. Answers will vary but will be only be from common POs.
- A3. Answers will vary.

Teaching Point 3

Revisit the Cadet Corps Full Value Contract

Time: 15 min

Method: Interactive Lecture



A corps full value contract (FVC) may have been developed in EO M107.01 (Participate in a Discussion on Year One Training). The information below is a refresher of the FVC.

Discuss the existing corps FVC. All cadets should be aware of the corps goals that were developed.

Re-evaluate and update the existing corps FVC. The cadets may agree that some goals need to be changed or that some need to be added or deleted.

If the corps does not have a FVC, the objectives and goals must still be discussed. No time has been allotted to complete a FVC in this lesson; however complementary time may be allocated as required. The instructions for completing a FVC are found at Annex A.

FULL VALUE CONTRACT

The objectives of the FVC are:

- respect integrity;
- respect diversity; and
- respect the individuals and the group to which the cadet belongs.

When instructors and cadets respect one another, it is easier to work together toward the same goal and support everyone in the learning process.

Goals of the FVC

Before establishing a FVC, everyone must be ready to commit to common goals.

Be Here. The FVC asks everyone to make a conscious commitment to be present in **body and mind**, as well as to commit to **full participation** and to accept and demonstrate responsibility for actions. This means that everyone will show interest in supporting each other and actively engaging in the learning process.

Be Safe. In order to stimulate interest, facilitate participation and create an open-minded environment for the group members; everyone must feel safe. It is the instructor's responsibility to ensure that team members feel physically and emotionally safe in order to contribute to their learning process. This responsibility also falls on group members. Behaviours and attitudes must not put other group members at risk. A safe environment will encourage each member to actively participate, ask questions and give answers without fear of being ridiculed.

Set Goals. It is essential that everyone set personal goals. These goals provide the person and the group reference points against which they will make choices about actions and plans. In every learning process, it is imperative to set goals. Once goals are set, group members and individuals will take on the responsibility to reach them. The FVC calls for the members of a group to work collectively toward the attainment of group goals and to support each other in meeting individual goals.

Be Honest. Being honest assumes that everyone is honest with others and with oneself. For example, in a situation of disappointment or anger, the team members must simply acknowledge their feelings in regard to the situation and openly and fairly explain their state of mind. In this situation, everybody will be able to work toward solving the problem. Being honest requires members to be accountable to each other and responsible for their own actions and words.

Let Go and Move On. The FVC requires that group members acknowledge that they will not always agree and that they will have different opinions and ideas. In this instance, members must choose to put aside differences and move forward in order to achieve the goals.

Using a FVC

FVCs can be used differently, but often work on their own. They become team-building tools for the group. One can refer to a FVC after an activity, experience, or situation by asking to the group how they have acted and reacted. Normally, group members will refer to it even before a leader does. Group members must be able to identify by themselves what went well and what did not. They must also be able to identify what they need to improve in order to respect their "contract".

CONFIRMATION OF TEACHING POINT 3

QUESTIONS

- Q1. What are the objectives of the FVC?
- Q2. Before letting go and moving on, what must happen?
- Q3. How is the FVC used?

ANTICIPATED ANSWERS

- A1. The objectives of the FVC are:
 - respect integrity;
 - respect diversity; and
 - respect the individuals and the group to which the cadet belongs.
- A2. Members must choose to put aside differences and move forward in order to achieve the goals.
- A3. One can refer to a FVC after an activity, experience, or situation by asking to the group how they have acted and reacted.

END OF LESSON CONFIRMATION

QUESTIONS

- Q1. What are some of the POs in Red Star that are specific to Army Cadets?
- Q2. What complementary training will the cadet corps participate in?
- Q3. What are the five goals of the FVC?

ANTICIPATED ANSWERS

- A1. PO 221 Field Training, PO 222 Navigation, PO 223 Trekking and PO 224 Wilderness Survival.
- A2. Answers will vary by cadet corps.
- A3. The five goals are:
- be here;
 - be safe;
 - set goals;
 - be honest; and
 - let go and move on.

CONCLUSION

HOMEWORK/READING/PRACTICE

N/A.

METHOD OF EVALUATION

N/A.

CLOSING STATEMENT

Cadets should know what can be expected in their training year in order to maintain interest in the program. Before opportunities occur, the cadets should have an idea of the training in which they would like to participate.

INSTRUCTOR NOTES/REMARKS

N/A.

REFERENCES

- A0-010 CATO 11-03 D Cdts 2. (2006). *Cadet Program Mandate*. Ottawa, ON: Department of National Defence.
- A2-031 CATO 40-01 D Cdts 3. (2003). *Army Cadet Program Outline*. Ottawa, ON: Department of National Defence.
- A2-035 CATO 41-05 D Cdts 4. (2006). *Army Cadet Expedition Program*. Ottawa, ON: Department of National Defence.

C2-038 (ISBN 0787224596) Henton, M. (1996). *Adventure in the Classroom: Using Adventure to Strengthen Learning and Build a Community of Life-long Learners*. Dubuque, IA: Kendall Hunt Publishing.

THIS PAGE INTENTIONALLY LEFT BLANK

ACTIVITY



A Full Value Contract (FVC) can take many forms. Examples of FVCs are located at Annex B.

Time: 30 min

OBJECTIVE

The objective of this activity is to develop a corps FVC which will help create a positive environment for each individual member and the entire group.

RESOURCES

Depending on the type of FVC that will be constructed, the following resources may be required:

- flipchart paper;
- cardboard;
- markers;
- pens/pencils;
- ruler;
- glue;
- scissors;
- coloured paper; and
- magazines, etc.

ACTIVITY LAYOUT

N/A.

ACTIVITY INSTRUCTIONS

1. Using flipchart paper to record ideas, brainstorm with the cadets by asking what values and qualities the group should adhere to in order to achieve goals.
2. Ensure all cadets have the same understanding of all the values and qualities noted.
3. Using flipchart paper to record ideas, have the cadets brainstorm a list of group behaviours that can help the group achieve goals.
4. Ensure all cadets have the same understanding of all the behaviours noted.
5. As an entire group, have the cadets represent their values and qualities by completing a FVC.

SAFETY

N/A.

THIS PAGE INTENTIONALLY LEFT BLANK

EXAMPLES OF FULL VALUE CONTRACTS

Full Value Contract: The Circle

Draw a wheel. At the centre of the wheel, draw a circle. This circle represents the individuals, the group, and the goals.

Draw rays from this circle. On these rays, write each selected value.

The outer circle symbolizes that the group is one and that all members go toward the same direction. Without the respect of the chosen values by everyone, the group could not make a wheel, and could not walk toward the same goals.



Figure B-1 The Circle

Note. Created by D Cdt3, 2007, Ottawa ON: Department of National Defence

Full Value Contract: The Village

Draw a frame on cardboard or flipchart paper.

Have the cadets think about values, qualities, and behaviours that make them feel safe and respected, both as an individual and in a group setting.

Every cadet must select their most important value, quality, or behaviour.

Have each cadet represent what they chose by drawing or writing it on a piece of paper.

Once completed, have each cadet glue their drawing or writing inside the frame (village) and briefly explain to the others why that choice was made.

Repeat the activity by including something that will prevent the group from reaching their goals and will destroy the running of the village.

Once again, have each cadet explain why they chose their representation. Next, each cadet will glue their drawing or writing outside the village.

Once the process is completed, mention every value selected by the cadets (inside and outside the village) and ask if everyone agrees. The cadets must understand that they are agreeing to respect each person's value, quality or behaviour in order for the cadet corps (village) to run properly and be a place where everyone will feel safe and respected.

After everyone has agreed, everyone (staff and cadets) will sign the village.

Full Value Contract: The Five-Finger Contract

Each finger will represent a value that will help the group members feel secure, respected, and part of the group.

The five fingers on the hand represent the following:

- the little finger = safety,
- the ring finger = commitment,
- the middle finger = respect of others,
- the index finger = taking responsibilities, and
- the thumb = agreement to work toward the group's goals.

On a piece of cardboard or flipchart paper, write the representations of the fingers. Discuss the elements with the group so that all cadets have a clear understanding. Each cadet must agree that these five elements are important for group members to feel secure, respected, and part of the group.

Each cadet will draw his/her hand on a sheet of paper and write inside each finger the element associated with each.

Each cadet will sign their hand and glue it on bristol board or flipchart paper. The set of the group's hands represents everyone's commitment to each other.



Figure B-2 The Five Finger Contract

Note. Created by D Cdts 3, 2007, Ottawa ON: Department of National Defence

Full Value Contract: The Being

Draw the outline of a cadet's body on a two pieces of flipchart paper, taped together.

Inside the outline, have the cadets draw or write the behaviours, qualities or values that will make the environment safe and a place where everyone is respected.

Outside the outline, have the cadets draw or write the behaviours, qualities or values that will prevent the environment from being safe and a place where everyone is respected.

Cadets must agree on the meaning of each word and explain their choices.

When completed, have all cadets sign the being.

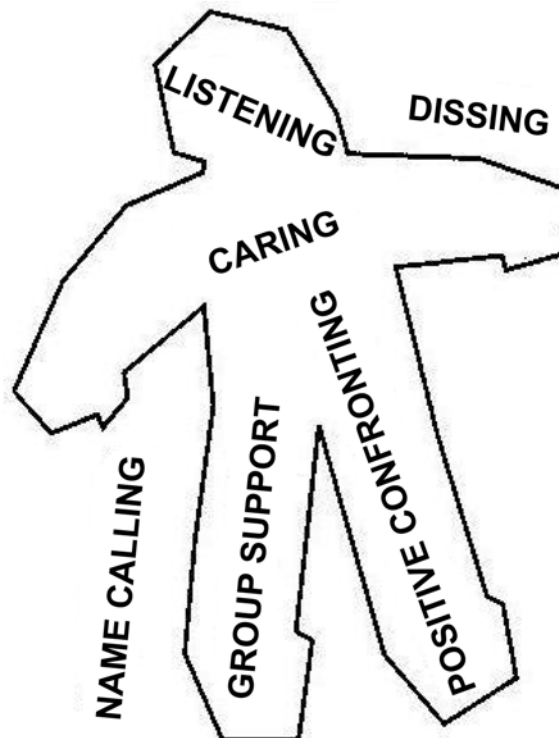


Figure B-3 The Being

Henton, M., Adventure in the Classroom: Using Adventure to Strengthen Learning and Build a Community of Life-long Learners, Kendall Hunt Publishing (p. 74)

Full Value Contract: The Chain of Hands

Have the cadets write a list of words and sentences that describe how they would like to be treated and how they will treat the other group members in order to feel safe and respected.

From this list, have the cadets select the 10 most important for the group.

On a sheet of flipchart paper (two may be required), have the cadets draw their hands around the sheet. Write the 10 selected words or sentences in the middle of the sheet.

Everyone must sign his or her own hand.

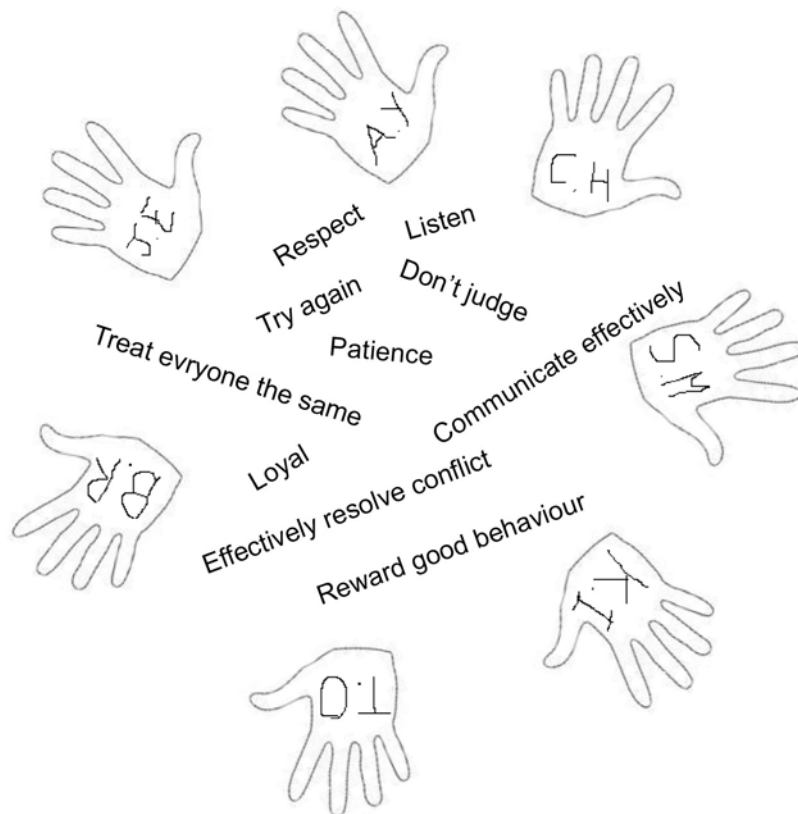


Figure B-4 The Chain of Hands

Note. Created by D Cdts 3, 2007, Ottawa ON: Department of National Defence.

Full Value Contract: What do I need? What can I give?

Give two pieces of different coloured paper to each cadet.

Ask them to think about what they need in order to feel secure and respected in the group.

Have the cadets write the most important item they need on one of the pieces of paper.

Now, ask them to think about what they could provide to the group in order to have other team members feel safe and respected in the group.

On the remaining piece of paper, they must write the most important one.

When done writing on both pieces of paper, have the cadets present what they wrote to the group.

Once everyone has explained what they need and what they can provide, glue those pieces of papers on cardboard or flipchart paper, making sure that both categories are split up.

Ask the cadets if they need more explanations and then have everyone sign.



ROYAL CANADIAN ARMY CADETS

RED STAR

INSTRUCTIONAL GUIDE



SECTION 2

EO M207.02 – RECOGNIZE THE HISTORY OF THE ROYAL CANADIAN ARMY CADETS (RCAC)

Total Time: 30 min

PREPARATION

PRE-LESSON INSTRUCTIONS

Resources needed for the delivery of this lesson are listed in the lesson specification located in A-CR-CCP-702/PG-001, Chapter 4. Specific uses for said resources are identified throughout the Instructional Guide within the TP for which they are required.

Review the lesson content and become familiar with the material prior to delivering the lesson.

Photocopy the handout of significant events located at Annex A for each cadet.

PRE-LESSON ASSIGNMENT

N/A.

APPROACH

An interactive lecture was chosen for TP1 and TP2 to orient the cadets to the history of the RCAC and to present basic material.

A group discussion was chosen for TP3 as it allows the cadets to interact with their peers and share their knowledge, experiences, opinions, and feelings about the history of the RCAC.

INTRODUCTION

REVIEW

N/A.

OBJECTIVES

By the end of this lesson the cadet shall have recognized the history of the RCAC.

IMPORTANCE

It is important to know the historical events of the RCAC. The significant events outlined contributed greatly to the Canadian Cadet Movement. By discussing significant historical events, cadets may develop an appreciation for history and for the organizations involved in shaping the Army Cadet Program into what it is today.

Teaching Point 1**Significant Events of the Army Cadet Program**

Time: 15 min

Method: Interactive Lecture



Using the handout located at Annex A, introduce the significant historical events.

RCAC HISTORY**The Formation of Drill Associations**

Motivated by the American Civil War and the threat of the Fenian Raids, Canada's first school cadet units were formed between 1861 and 1865, several years before Confederation. These early cadet units were called "drill associations". In those days drill was not a parade square exercise but the method of manoeuvring troops in battle. These early drill associations could have included members ranging in age from 13 to 60, so it might be argued that they were not really cadet corps but auxiliary militia companies.

The distinction between high school cadets and adult militiamen became clear in 1879 when the Militia General Order 18 authorized the formation of 74 "Associations for Drill in Educational Institutions," for young men over 14 years of age who were "upon no account to be employed in active service." The cadets provided their own uniforms. The cadets in the photograph below imported their uniforms from Scotland at such great expense that only one youth per family could afford to belong.



Figure 1 Cadet Corps from 1890

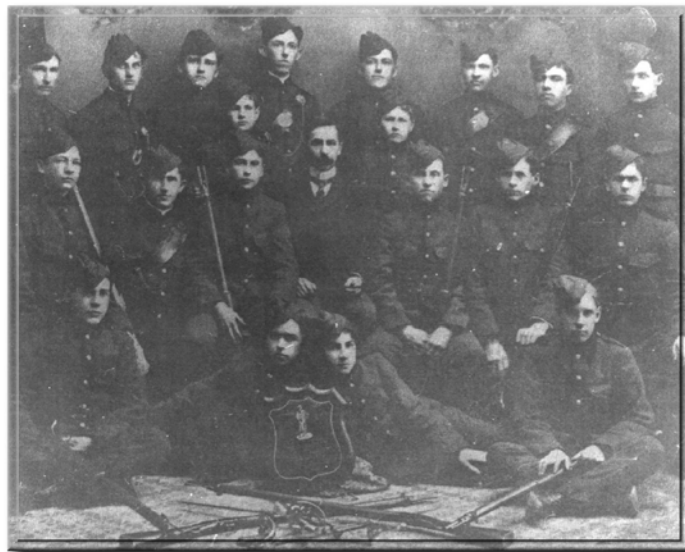
A-CR-CCP-121/PT-001 (p. 2-20)

The 74 drill associations authorized in 1879 included 34 in Ontario, 24 in Quebec, 13 in the Maritime Provinces, 2 in Manitoba, and 1 in British Columbia. Canada's oldest continually serving cadet corps is No. 2 Bishop's College School Cadet Corps in Lennoxville, Quebec, which was formed by the authority of Militia General Orders on December 6, 1861.

By 1887, the drill associations had detailed regulations governing their formation and activities. Arms and other equipment were issued to those schools that agreed to provide military training to boys over the age of 12.

The school supplied accommodations and instructors and kept attendance records. Members supplied their own uniforms. This increased support was motivated in part by the campaign against the North-West Rebellion of 1885.

The term “Cadet Corps” appeared for the first time in Ontario in 1898, along with a provision that corps instructors would be members of the school teaching staff, instead of an instructor from the local militia unit. Militia General Orders 60 and 61, of 1899, first authorized cadet corps to be attached to militia units, limiting membership to young men 14–19 years old.



#10 MOUNT FOREST HIGH SCHOOL CADET CORPS - 1902

Figure 2 Cadet Corps from 1902

A-CR-CCP-121/PT-001 (p. 2-21)

The First Commissioned Officers

In 1904, the current numbering system was established to identify cadet corps in their sequence of formation. In 1908, a cadre of commissioned officers was formed which was comprised of school teachers whom the Department of Militia and Defence trained and paid to conduct drill and physical training in participating schools. This officer cadre was called the Cadet Services of Canada. It was a component of the Canadian Army and the forerunner of the current Cadet Instructor Cadre (CIC). This arrangement between the Federal Government and local school boards contributed significantly to the development of physical education programs in Canadian schools.

The Contributions from Lord Strathcona

In 1910, Lord Strathcona (Sir Donald Alexander Smith), the Canadian High Commissioner to Britain, deposited in trust with the Dominion Government \$500 000, bearing an annual interest at 4 percent, to develop citizenship and patriotism in school cadets through physical training, rifle shooting, and military drill. Nearly a century later, the Strathcona Trust is still providing equipment for cadet training. About \$50 000 is distributed each year to Strathcona Trust committees across Canada.

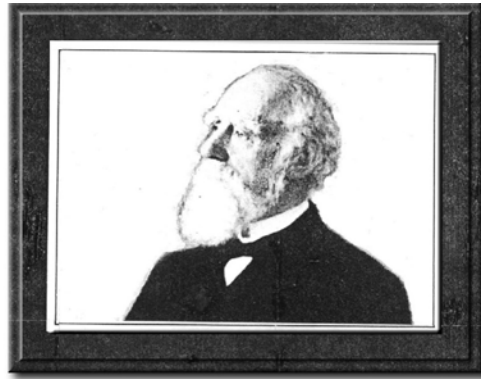


Figure 3 Sir Donald Alexander Smith, Lord Strathcona
A-CR-CCP-121/PT-001 (p. 2-22)



Figure 4 Lord Strathcona Medal

Note. From "Lord Strathcona Trust Fund Medal", 2007, Army Cadet League of Canada (Ontario). Copyright 2007 by the Army Cadet League of Canada (Ontario). Retrieved 16 April 2007, from <http://www.cyberbeach.net/army/badges/lordst~1.jpg>

The Impact of World War I (WWI)

The Army Cadet organization flourished during the beginning of the 20th century. Some 40 000 former Army Cadets served in Canada's forces during WWI, and by the end of the war there were about 64 000 cadets enrolled in Army Cadet corps across Canada.

The 1928 Regulations for the Cadet Services of Canada directed Army Cadet leaders to "...impart mental, moral, and physical training to their Cadets and [seek] to develop in them principles of patriotism and good citizenship." It went on to recommend about cadet training, "The exercises need not be of too rigid a military pattern. Discipline, individual and collective, is essential, and drill of an elementary character is to be encouraged, but gymnastic exercises, physical drill, signalling, scouting, swimming, despatch riding, bridge building, map reading, and all forms of training that tend to produce physical fitness, mental and bodily alertness, individuality, self-reliance, and resourcefulness in emergencies are to be regarded as of not less value than military drill pure and simple."

The Impact of World War II (WWII)

When WWII began, public interest in cadet training was revived and cadet corps were formed in many high schools. It is estimated that nearly 124 000 former Army Cadets served in Canada's forces during WWII, with more than 19 000 receiving commissions and over 2700 awarded decorations.

After WWII, the summer camp philosophy changed to incorporate the lessons learned from 1940-1945, that primarily being the evolution of technology and its various uses in the Canadian Army. Now the Army Cadet summer camps became much more than the traditional 10-day camps, they began to include trades training: Infantry Basic Training, Signals, Special Engineering Equipment, Driver and Mechanic, and Fire Control Equipment. They were determined from all the trades that had been important during war time, however this time with a threat implied – Canada would not be caught unprepared.

Given the Title “Royal”

In 1942, in recognition of the significant contribution of former cadets to the war effort, His Majesty King George VI conferred the title “Royal” on the Royal Canadian Army Cadets and accepted the appointment of “Colonel-in-Chief” of the Royal Canadian Army Cadets. His Royal Highness Prince Philip, Duke of Edinburgh, presently holds this appointment.

Next Reorganization of Cadet Training

In 1944, “RCAC Training Programme” listed Fundamentals, Health and Physical Education, Drill and Command, Small Arms Training, Knots, Fieldcraft, Signalling, Band, First Aid, Woodcraft, Use of Maps, Organized Sports, I.C. (Internal Combustion) Engines, Weapon Training, and Instruction as authorized training subjects. Corps were assessed at their annual inspection and rated as to their efficiency (ability to show cadets were trained in all subjects). The corps would then receive funding based on their annual inspection score.

After World War II, quotas were imposed reducing Canada’s total cadet force to about 75 000 members. Many of the “closed” corps, those whose membership was restricted to the students in one particular school, were disbanded or withered away after their school made membership voluntary. Some of them became “open” corps, training in militia armouries, Legion halls or acquiring their own buildings. The Korean War stimulated growth among these “open” corps in the 1950s and 1960s.

The Introduction of the RCAC Crest

In 1956, Her Majesty Queen Elizabeth authorized a new design for the RCAC crest, including the motto “ACER ACERPORI” which means “As the maple, so the sapling”.



Figure 5 Royal Canadian Army Cadet Crest

Note. From History & Heritage Committee, Army Cadet League of Canada, 2007, Army Cadet History. Copyright 1995-2007 by the Army Cadet League of Canada. Retrieved 16 April 2007, from http://www.armycadethistory.com/Main_page.htm

The Unification of the Canadian Forces (CF)

During the period of 1964-1966, the CF underwent a complete reorganization. This ended with the unification of the CF on February 1, 1968. It consisted of a merger of the Canadian Navy, Army and Air Force into one unified structure.

At this time, the Cadet Services of Canada became the Cadet Instructors List (CIL), and the Directorate of Cadets (D Cdts) was formed at National Defence Headquarters (NDHQ). D Cdts was established in Ottawa to set policy and coordinate the activities of the Sea, Army and Air Cadets.

The Inclusion of Girls

Girls have participated unofficially in cadet training almost from the beginning. There were always a few cadet corps that paraded a female platoon or company in some form of uniform. These unofficial female cadets could never lawfully be trained, issued uniforms or equipment, fed, transported or allowed to attend summer training. The problem was solved on July 30, 1975 when Parliament passed Bill C-16, amending the relevant legislation by changing the word “boys” to “persons”, thereby permitting females to become members of the RCAC.

The New Uniform

In 1977, a new uniform (dark green to match the colours of the CF Army uniforms) was issued to Army Cadets, replacing the wool tunics, pants and putties (waterproof cloths that were wrapped around the lower leg).



By the early 1950s, the cadets began to wear the new battle dress tunics, almost identical to the regular force and reserve uniforms. The difference between the 1942 pattern and the 1950 pattern was the tunic being shorter in the 1950 pattern and the waist belt being replaced by a smaller belt at the bottom of the tunic.



Figure 6 1942 Pattern Uniform

Note. From History & Heritage Committee Army Cadet League of Canada, 2007, Accoutrements, Shoulder Flashes, Hat Badges and Uniforms. Copyright 1995-2007 by the Army Cadet League of Canada. Retrieved 23 April 2007, from <http://www.armycadethistory.com/Uniforms.htm>



Figure 7 1950 Pattern Uniform

Note. From History & Heritage Committee, Army Cadet League of Canada, 2007, Accoutrements, Shoulder Flashes, Hat Badges and Uniforms. Copyright 1995-2007 by the Army Cadet League of Canada. Retrieved 23 April 2007, from <http://www.armycadethistory.com/Uniforms.htm>

The Presentation of the Army Cadet Banners

On August 20, 1985, at the National Army Cadet Camp in Banff, Alberta, His Royal Highness Prince Philip, Colonel-in-Chief, presented the Royal Canadian Army Cadet Banner, the Royal Canadian Army Cadet Pipe Banner and the Royal Canadian Army Cadet Trumpet Banner.



Figure 8 The Royal Canadian Army Cadet Banner

Note. From Department of National Defence, 2007, Symbols of the Royal Canadian Army Cadets. Retrieved 16 April 2007, from http://www.cadets.ca/armcad/resources-ressources/symbols/army_flags/army_flags.htm



Figure 9 The Royal Canadian Army Cadet Trumpet Banner

Note. From Department of National Defence, 2007, Symbols of the Royal Canadian Army Cadets. Retrieved 16 April 2007, from http://www.cadets.ca/armcad/resources-ressources/symbols/army_flags/army_flags.htm



Figure 10 The Royal Canadian Army Cadet Pipe Banner

Note. From Department of National Defence, 2007, Symbols of the Royal Canadian Army Cadets. Retrieved 16 April 2007, from http://www.cadets.ca/armcad/resources-ressources/symbols/army_flags/army_flags.htm

The Change of Enrolment Age

In 1987, the enrolment age was returned to 12 years old.

The Cadet Instructor Cadre (CIC)

The Cadet Instructors List (CIL) became the Cadet Instructor Cadre (CIC) on 20 July 1994, which allowed the use of a bilingual format for both the title and the acronym.

The 125th Anniversary

2004 marked the 125th anniversary of the Royal Canadian Army Cadets. Canada Post honoured the Army Cadets with a commemorative stamp, which was unveiled in Ottawa on March 26, 2004.



Figure 11 Army Cadet Stamp Issued by Canada Post

Note. From History & Heritage Committee, Army Cadet League of Canada, 2007, Army Cadet History. Copyright 1995-2007 by the Army Cadet League of Canada. Retrieved 16 April 2007, from http://www.armycadethistory.com/Main_page.htm

The Updates to Modern Form

In 1999, the Army Cadet Program was updated and “adventure and challenge” were the principle elements.

In September 2008, the Army Cadet Program was updated. The key objectives for this update were improving management and administration, connecting the three elements, and incorporating current professional practices from the fields of education and youth development. The expedition program was entrenched in the Army Cadet Program as the primary mechanism of program delivery.

CONFIRMATION OF TEACHING POINT 1

QUESTIONS

- Q1. In what year did Lord Strathcona develop a \$500 000 trust for Army Cadets?
- Q2. What bill allowed females to become members of Army Cadets?
- Q3. When, where, and by whom was the RCAC Banner presented?

ANTICIPATED ANSWERS

- A1. The trust was developed in 1910.
- A2. Bill C-16 allowed females to become members of Army Cadets.
- A3. The RCAC Banner was presented on August 20, 1985, at the National Army Cadet Camp in Banff, Alberta, by His Royal Highness Prince Philip.

Teaching Point 2

Significant Events for the Army Cadet League of Canada

Time: 5 min

Method: Interactive Lecture



Using corps-specific examples when possible, discuss the Army Cadet League of Canada.

History of the Army Cadet League of Canada

The unification of Canada's armed forces caused some fundamental changes to the Army Cadet organization. Prior to this, the Cadet Services of Canada (CS of C) represented the movement at Army headquarters on behalf of the sponsors, communities and cadet leadership. The CS of C, a sub-component of the Army Reserve with membership on the Canadian Defence Association, had considerable influence in cadet matters.

The Army Cadet League of Canada was formed on April 1, 1971, to give the Army Cadets a civilian voice that was comparable to that of the Navy League of Canada and the Air Cadet League of Canada. Pressure was applied to the Army to conform to this structure and assist with a civilian voice. The Army Cadet League began to work with the Department of National Defence (DND) to assist in the administration of the Army Cadet movement.

The Army Cadet League of Canada is a civilian non-profit organization, committed to supporting Army Cadets by working in partnership with local communities and the CF. They assist in the development of policies and methods for achieving the aims and objectives of the CCM in general, and the RCAC in particular. They are a registered charitable organization and are supported by donations and a grant from DND. They also hold fundraising events to provide financial assistance when possible.

There is a national office, located in Ottawa, Ontario as well as branch offices located in each province and three in the northern region. There is a small cadre of full-time staff members at the national office, however most members are volunteers.

The Objectives of the Army Cadet League

The objectives of the Army Cadet League are to carry out the following tasks:

1. Encourage and promote public interest in and support for the Royal Canadian Army Cadets.
2. Facilitate and recommend the formation of Army Cadet corps.
3. Assist in the recruitment of cadet instructors and participate in the recruitment of cadets.
4. Provide and supervise local sponsors.
5. Ensure that the Army Cadet Program is adventure-oriented, challenging, consistent with their aims and relevant to present society.

6. Collect, receive, hold and invest funds and property from contributions, gifts, grants, subscriptions or legacies, and use such funds, subject to the donor's direction, for the benefit of the RCAC.
7. Protect the overall interests of the Army Cadet League of Canada.

CONFIRMATION OF TEACHING POINT 2

QUESTIONS

- Q1. Why was the Army Cadet League of Canada formed?
- Q2. How does the League provide financial aid?
- Q3. What is the relationship between the League and the public?

ANTICIPATED ANSWERS

- A1. The unification of Canada's armed forces caused major changes to the Army Cadet Organization. The Air and Sea Cadets were represented by their respective leagues and consequently, pressure was applied to the Army to conform to this structure and assist with a civilian voice.
- A2. The Army Cadet League is supported by donations and a grant from DND. They may also hold fundraising events in order to provide financial assistance when possible.
- A3. The Army Cadet League is responsible for encouraging and promoting public interest in and support for the Royal Canadian Army Cadets.

Teaching Point 3

Reflect on the History of the RCAC

Time: 5 min

Method: Group Discussion

BACKGROUND KNOWLEDGE



The point of the group discussion is to draw aspects of the history of the RCAC from the group using the tips for answering/facilitating discussion and the suggested questions provided.

Using the information presented throughout this lesson, conduct a group discussion with the cadets.

GROUP DISCUSSION



TIPS FOR ANSWERING/FACILITATING DISCUSSION

- Establish ground rules for discussion, e.g. everyone should listen respectfully; don't interrupt; only one person speaks at a time; no one's ideas should be made fun of; you can disagree with ideas but not with the person; try to understand others as much as you hope they understand you; etc.
- Sit the group in a circle, making sure all cadets can be seen by everyone else.
- Ask questions that will provoke thought; in other words avoid questions with yes or no answers.
- Manage time by ensuring the cadets stay on topic.
- Listen and respond in a way that indicates you have heard and understood the cadet. This can be done by paraphrasing their ideas.
- Give the cadets time to respond to your questions.
- Ensure every cadet has an opportunity to participate. One option is to go around the group and have each cadet answer the question with a short answer. Cadets must also have the option to pass if they wish.
- Additional questions should be prepared ahead of time.

SUGGESTED QUESTIONS

- Q1. What events were interesting?
- Q2. What events have a direct impact on the training received today?
- Q3. What would be different if Bill C-16 was not passed? How would cadet corps be affected?
- Q4. How does the league assist the cadet corps?



Other questions and answers will develop throughout the reflection stage. The discussion should not be limited to only those suggested.



Reinforce those answers given and comments made during the group discussion, ensuring the teaching point has been covered.

CONFIRMATION OF TEACHING POINT 3

The cadets' participation in the group discussion will serve as the confirmation of this TP.

END OF LESSON CONFIRMATION

The cadets' participation in the discussion of the history of the RCAC will serve as the confirmation of this lesson.

CONCLUSION

HOMEWORK/READING/PRACTICE

N/A.

METHOD OF EVALUATION

N/A.

CLOSING STATEMENT

Knowing the past develops an appreciation and a sense of pride of the people and events that contributed to what exists today. Learning history is an important aspect of being an Army Cadet.

INSTRUCTOR NOTES/REMARKS

N/A.

REFERENCES

A0-036 A-CR-CCP-121/PT-001 D Cdts 3. (2000). *Royal Canadian Army Cadet Reference Book*. Ottawa, ON: Department of National Defence.

A0-045 Cadets Canada. (2007). *About Cadets – History*. Retrieved 19 February 2007, from http://www.cadets.ca/about-nous/histo_e.asp.

C2-063 Army Cadet League of Canada. (2007). *Army Cadet League of Canada*. Retrieved 9 March 2007, from <http://www.armycadetleague.ca>.

SUMMARY OF SIGNIFICANT EVENTS

Date	Event
1861	Formation of drill associations began.
1879	Distinction between high school cadets and adult militiamen became clear with Militia General Order 18.
1887	The drill associations had detailed regulations governing their formation and activities.
1898	The term “Cadet Corps” appeared for the first time.
1898	A condition that corps instructors must be a member of the school teaching staff, instead of an instructor from the local militia unit, was adopted.
1899	Militia General Orders 60 and 61 authorized cadet corps to be attached to militia units.
1904	The current numbering system was established to identify corps in the sequence of their formation.
1908	The first cadre of commissioned officers called the Cadet Services of Canada was formed. This cadre consisted of school teachers.
1910	Lord Strathcona deposited \$500 000 in a trust to develop citizenship and patriotism in school cadets through physical training, rifle shooting, and military drill.
1928	“Regulations for the Cadet Services of Canada” directed Army Cadet leaders to develop patriotism and good citizenship in their cadets.
1942	His Majesty King George VI conferred the title “Royal” on the Royal Canadian Army Cadets.
1956	Her Majesty Queen Elizabeth authorized a new design for the RCAC crest, including the motto “ACER ACERPORI”, “As the maple, so the sapling”.
01-Feb-68	Unification of the Canadian Armed Forces. The Cadet Services of Canada became the Cadet Instructors List (CIL) and the Directorate of Cadets (D Cdts) was formed at National Defence Headquarters (NDHQ).
01-Apr-71	The Army Cadet League of Canada was formed.
30-Jul-75	Parliament passed Bill C-16 which amended legislation by changing the word “boys” to “persons”, thereby permitting females to become members of the RCAC.
1977	The dark green uniform was adopted.

Date	Event
20-Aug-85	His Royal Highness Prince Philip presented the Royal Canadian Army Cadet Banner, the Royal Canadian Army Cadet Pipe Banner and the Royal Canadian Army Cadet Trumpet Banner at the National Army Cadet Camp in Banff, Alberta.
1987	The enrolment age was returned to 12 years old.
1994	The Cadet Instructors List (CIL) became the Cadet Instructor Cadre (CIC), which allowed the use of a bilingual format for both the title and the acronym.
1999	The Army Cadet Program was updated with emphasis on “adventure and challenge”.
2009	The Army Cadet Program was updated to its modern form.



ROYAL CANADIAN ARMY CADETS

RED STAR

INSTRUCTIONAL GUIDE



SECTION 3

EO M207.03 – RECOGNIZE THE ROLE AND RESPONSIBILITIES OF THE LOCAL SPONSOR

Total Time: 30 min

PREPARATION

PRE-LESSON INSTRUCTIONS

Resources needed for the delivery of this lesson are listed in the lesson specification located in A-CR-CCP-702/PG-001, Chapter 4. Specific uses for said resources are identified throughout the Instructional Guide within the TP for which they are required.

Review the lesson content and become familiar with the material prior to delivering the lesson.

Become familiar with the cadet corps local sponsor and sponsoring committee. Be prepared to give examples of what the sponsor does for the cadet corps.

Contact members of the local sponsor and invite them to participate in this EO.

PRE-LESSON ASSIGNMENT

N/A.

APPROACH

An interactive lecture was chosen for this lesson to orient the cadets to the role and responsibilities of the local sponsor and to present basic material.

INTRODUCTION

REVIEW

N/A.

OBJECTIVES

By the end of this lesson the cadet shall recognize the role and responsibilities of the local sponsor.

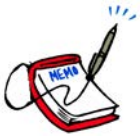
IMPORTANCE

It is important for cadets to know the support structure of their cadet corps. Every cadet corps across Canada has a local sponsor who provides assistance to help complete training. For a cadet corps to run effectively, it needs a variety of support structures. A dependable and reliable sponsor is key to the success of a cadet corps and each cadet should be aware of their importance.

Teaching Point 1**Define Sponsor and Sponsoring Committee**

Time: 15 min

Method: Interactive Lecture



Provincial/territorial branches of the Army Cadet League may refer to the sponsoring committee as a different term (e.g. support committee). Ensure the cadets know who the cadet corps sponsor and sponsoring committee are.

Discuss the difference between a sponsor and a sponsoring committee.

SPONSOR VERSUS SPONSORING COMMITTEE

Sponsor. With respect to a cadet corps, the organization or persons accepted by or on behalf of the Chief of Defence Staff to undertake jointly with the Canadian Forces and the supervisory sponsor (the Army Cadet League), responsibility for the organization and administration of the cadet corps.

Sponsoring Committee. A working support committee that is a member of and supervised by the league and is comprised of persons who are approved, registered and screened in accordance with league policy to complete the functions required to support the corps. Sponsoring committees are normally comprised of representative(s) of the sponsor, parents, and other acceptable civilian parties from the community. They are sometimes called parents' committees or civilian committees; however, not every parents' committee is a sponsoring committee.



A cadet corps is required to have a sponsor. Sponsoring committees complement the support offered by the local sponsor. If there is no sponsoring committee, the league expects the sponsor to either form one or assume the responsibilities.

The sponsoring committee may be a large part of the cadet corps. There have been cases where the sponsoring committee has contributed more than the sponsor, so they applied to become the sponsor.



The following is a general structure of positions within the sponsor and the basic responsibilities corresponding to the positions. These positions may vary or terms may change from sponsor to sponsor.

Chairperson. The chairperson is the senior official in the sponsoring body and is responsible for all activities/functions. All members must keep chairperson informed of their activities and he/she in turn must keep the corps informed of activities within the sponsor.

Secretary. The secretary is responsible for maintaining all of the records and correspondence. During committee and general meetings, the secretary is responsible for recording the minutes.

Treasurer. The treasurer is responsible for maintaining all financial records and transactions. All expenditures should be recorded for purposes of budgeting and financial reporting.

CONFIRMATION OF TEACHING POINT 1**QUESTIONS**

- Q1. What is a sponsor?
- Q2. Who normally comprises a sponsoring committee?
- Q3. Who is the cadet corps sponsor?

ANTICIPATED ANSWERS

- A1. With respect to a cadet corps, the organization or persons accepted by or on behalf of the Chief of Defence Staff to undertake jointly with the Canadian Forces and the supervisory sponsor (The Army Cadet League), responsibility for the organization and administration of the cadet corps.
- A2. Sponsoring committees are normally comprised of representative(s) of the sponsor, parents, and other acceptable civilian parties from the community.
- A3. Answers will vary.

Teaching Point 2**Discuss the History of the sponsoring Committee**

Time: 5 min

Method: Interactive Lecture

HISTORY OF THE SPONSORING COMMITTEE

As stated in Issue 11 of *Cadence: The Leadership Magazine of the Canadian Cadet Movement*, prior to the formation of The Army Cadet League of Canada on April 1, 1971, cadet corps were sponsored by Militia or Regular Force units affiliated with each corps. These regimental units wanted to provide youth with a unique opportunity to develop interdependence and personal character. The approach taken was firmly based on that unit's own history and traditions.

Cadet corps relied on their regiment for support and leadership. Parent involvement was unwanted and financial aid was infrequent.

With budget restrictions to the Canadian Forces, support became less available from the affiliated unit. In order to save corps, parents across Canada became involved by raising money and providing support.

When The Army Cadet League of Canada formed, a main area of concern was support to the cadet corps. The league set out to form structured sponsoring committees at each corps to add to the support that the local sponsor provided. These committees were community-based, consisting of parents, league members, members of military associations and volunteers. Originally, many commanding officers opposed these committees, but now appreciate the assistance. Today, these committees are a major source of support.

CONFIRMATION OF TEACHING POINT 2**QUESTIONS**

- Q1. When was the Army Cadet League of Canada formed?
- Q2. Prior to the formation of The Army Cadet League of Canada, who sponsored cadet corps?
- Q3. Who were the main people that helped to form the first sponsoring committees?

ANTICIPATED ANSWERS

- A1. The Army Cadet League was formed on April 1, 1971.
- A2. Prior to The Army Cadet League of Canada, Militia or Regular Force units affiliated with each corps sponsored cadet corps.
- A3. Parents, league members, members of military associations and volunteers were the main sources of support in forming these committees.

Teaching Point 3

Explain the Role and Responsibilities of the Local Sponsor

Time: 5 min

Method: Group Discussion



Discuss the role and responsibilities using corps-specific examples.

ROLE OF THE SPONSOR

It is the role of the sponsor to ensure responsibilities are met in accordance with the *Memorandum of Understanding*, for the proper and efficient delivery of the Cadet Program within Canada.

RESPONSIBILITIES OF THE SPONSOR

Fundraising

It is the responsibility of the sponsor to organize fundraising activities in consultation with the corps commanding officer (CO). Annual reports are to be produced by the sponsor when required by law.

Recruiting Cadets

It is the responsibility of the sponsor to organize local community campaigns to attract cadets to become members of the corps.

Attracting Officers to the Corps

It is the responsibility of the sponsor to conduct local campaigns to attract potential candidates within the community to become members of the Cadet Instructors Cadre (CIC) and civilian instructors (CIs). This is based on the needs confirmed by the CO of the corps.

Screening Volunteers

It is the responsibility of the sponsor to identify and conduct the screening process of potential volunteers. The sponsor is responsible for completing the process and providing these results to the league.

Providing Adequate Office and Training Facilities

The sponsor is responsible for providing adequate office and training facilities, where they are not provided by DND. This is to include insurance requirements, as necessary.

Participating in Senior Cadet Rank Appointments

The sponsor is responsible to assist with the selection process for senior cadets.

Participating in Selections for CSTC/Exchanges

The sponsor is responsible for cooperating with the corps CO to promote summer courses and exchanges and to participate in the selection process accordingly, in accordance with the league and DND agreements and responsibilities.

Participating in Selections for Honours and Awards

The sponsor is responsible for participating in the joint selection process for honours and awards from the league and in initiating the selection process for league-specific awards.



The sponsor plays an important role in developing and maintaining positive community relationships with businesses, municipal government, local service clubs, and the affiliated unit.

CONFIRMATION OF TEACHING POINT 3

QUESTIONS

- Q1. What role does the sponsor play in fundraising?
- Q2. Who is responsible for recruiting CIC officers, CIs, and cadets to the corps?
- Q3. Who is responsible for providing office and training facilities?

ANTICIPATED ANSWERS

- A1. It is the responsibility of the sponsor to organize fundraising activities in consultation with the corps CO.
- A2. The sponsor.
- A3. The sponsor.

END OF LESSON CONFIRMATION

QUESTIONS

- Q1. What is a sponsor?
- Q2. What support does the sponsor provide the corps?
- Q3. How does the sponsor assist the CO?

ANTICIPATED ANSWERS

- A1. With respect to a cadet corps, the organization or persons accepted by or on behalf of the Chief of Defence Staff to undertake jointly with the Canadian Forces and the supervisory sponsor (the Army Cadet League), responsibility for the organization and administration of the cadet corps.
- A2. Answers will vary.
- A3. Answers will vary.

CONCLUSION

HOMEWORK/READING/PRACTICE

N/A.

METHOD OF EVALUATION

N/A.

CLOSING STATEMENT

The sponsor of a cadet corps has a role and many responsibilities to fulfill, most importantly support and financial aid. Though they are not always seen, a dependable and reliable sponsor is key to the success of a cadet corps and each cadet should recognize their importance.

INSTRUCTOR NOTES/REMARKS

This lesson may be delivered by a member of the local sponsor.

REFERENCES

A0-040 2005-113124 D Cdts. (2005). *Memorandum of Understanding Between the DND and the Leagues*. Ottawa, ON: Department of National Defence.

A0-046 Scott, M (Ed.). (2003). Clarifying Civilian Roles in Cadet Corps and Squadrons. *Cadence: The Leadership Magazine of the Canadian Cadet Movement*, Issue 11, 30-32.

C2-063 Army Cadet League of Canada. (2007). *Army Cadet League of Canada*. Retrieved 9 March 2007, from <http://www.armycadetleague.ca>.



ROYAL CANADIAN ARMY CADETS

RED STAR

INSTRUCTIONAL GUIDE



SECTION 4

EO M207.04 – IDENTIFY YEAR TWO CSTC TRAINING OPPORTUNITIES

Total Time: 30 min

PREPARATION

PRE-LESSON INSTRUCTIONS

Resources needed for the delivery of this lesson are listed in the lesson specification located in A-CR-CCP-702/PG-001, Chapter 4. Specific uses for said resources are identified throughout the Instructional Guide within the TP for which they are required.

Review the lesson content and become familiar with the material prior to delivering the lesson.

PRE-LESSON ASSIGNMENT

N/A.

APPROACH

A group discussion was chosen for TP1 as it allows the cadets to interact with their peers and share their experiences, opinions, and feelings about year two CSTC training opportunities.

An interactive lecture was chosen for TP2 to orient the cadets to year two CSTC training opportunities and to generate interest.

INTRODUCTION

REVIEW

N/A.

OBJECTIVES

By the end of this lesson the cadet shall be expected to identify year two CSTC training opportunities.

IMPORTANCE

It is important for cadets to identify year two CSTC training opportunities available to them because they must decide if and for which course they would like to apply.

Teaching Point 1**Discuss the Specialty Areas for Year Two CSTC Training**

Time: 10 min

Method: Group Discussion

BACKGROUND KNOWLEDGE



The point of the group discussion is to draw the following information from the group using the tips for answering/facilitating discussion and the suggested questions provided.

Write the specialty areas on a whiteboard/flipchart and discuss the activities associated within each area. Cadets may already know which area they would like to pursue and may already have a general idea of the activities.

LEADERSHIP/DRILL AND CEREMONIAL

Cadets will develop the knowledge and skills required to improve leadership abilities in a peer and small group (3–6 pers) setting. Activities include:

- leadership;
- confidence building;
- public speaking;
- problem solving; and
- ceremonial drill.

FITNESS AND SPORTS

Cadets will improve individual fitness and sport knowledge and skills. Activities include:

- rules and regulations of sports; and
- personal fitness.

MUSIC**Military Band**

Cadets will develop music knowledge and skills. Activities include:

- music theory;
- playing an instrument as part of an ensemble;
- playing an instrument as part of a military band; and
- developing individual music skills.

Pipe and Drum

Cadets will develop music knowledge and skills. Activities include:

- music theory;
- playing an instrument as part of an ensemble;

- playing an instrument as part of a pipe and drum band; and
- developing individual music skills.

MARKSMANSHIP

Cadets will develop the knowledge and skills required to improve marksmanship abilities. Activities include:

- two-position shooting (standing and prone);
- recreational marksmanship;
- course level marksmanship competition; and
- biathlon.

EXPEDITION

Cadets will develop expedition knowledge and skills in a field setting. Activities include:

- adventure training activities;
- field training;
- trekking;
- navigation; and
- wilderness survival.

GROUP DISCUSSION




TIPS FOR ANSWERING/FACILITATING DISCUSSION


- Establish ground rules for discussion, e.g. everyone should listen respectfully; don't interrupt; only one person speaks at a time; no one's ideas should be made fun of; you can disagree with ideas but not with the person; try to understand others as much as you hope they understand you; etc.
- Sit the group in a circle, making sure all cadets can be seen by everyone else.
- Ask questions that will provoke thought; in other words avoid questions with yes or no answers.
- Manage time by ensuring the cadets stay on topic.
- Listen and respond in a way that indicates you have heard and understood the cadet. This can be done by paraphrasing their ideas.
- Give the cadets time to respond to your questions.
- Ensure every cadet has an opportunity to participate. One option is to go around the group and have each cadet answer the question with a short answer. Cadets must also have the option to pass if they wish.
- Additional questions should be prepared ahead of time.

SUGGESTED QUESTIONS:

- Q1. Which summer training activities interest you?
- Q2. Who is interested in applying for summer training this year? Why?
- Q3. What specialty area are you interested in pursuing? Why?



Other questions and answers will develop throughout the group discussion. The group discussion should not be limited to only those suggested.



Reinforce those answers given and comments made during the group discussion, ensuring the teaching point has been covered.

CONFIRMATION OF TEACHING POINT 1


The cadets' participation in the group discussion will serve as the confirmation of this TP.

Teaching Point 2

Time: 15 min

Describe Year Two CSTC Courses

Method: Interactive Lecture



A cadet who has attended one of these courses could be asked to speak about their experience during this TP.

COMMON COURSES

Basic Fitness and Sports. The aim of this course is to improve the cadets' knowledge and skills in individual fitness and sports.

Military Band – Basic Musician. The aim of this course is to introduce fundamental music knowledge and skills, and for the cadet to achieve a basic music level.

Pipe Band – Basic Pipe Band Musician. The aim of this course is to introduce fundamental music knowledge and skills, and for the cadet to achieve a basic music level.

ELEMENTAL COURSES

Basic Leadership. The aim of this course is to build on the knowledge and skills required for an emerging leader to complete a leadership assignment in a peer and small group setting and to provide course cadets with the opportunities to build self-confidence.

Basic Marksman. The aim of this course is to develop cadets' marksmanship knowledge and skills, allowing them to participate in a local marksmanship competition.

Basic Expedition. The aim of this course is to develop specialists with skills and subject matter knowledge required to successfully participate in a basic level expedition.



The only pre-requisite for a year two CSTC course is the successful completion of the Red Star training program.

CONFIRMATION OF TEACHING POINT 2

QUESTIONS

- Q1. What courses are available for second year cadets?
- Q2. What music level are cadets expected to achieve after completion of a year two music course?
- Q3. What are two topics covered on the Basic Expedition Course.

ANTICIPATED ANSWERS

- A1. Courses include:
- basic fitness and sports;
 - basic military band musician;
 - basic pipe band musician;
 - basic marksman;
 - basic leadership; and
 - basic expedition.
- A2. The cadet is expected to achieve a basic music level.
- A3. Topics include adventure training activities, field training, trekking, navigation and wilderness survival.

END OF LESSON CONFIRMATION

The cadets' participation in the group discussion will serve as the confirmation of this lesson.

CONCLUSION

HOMEWORK/READING/PRACTICE

N/A.

METHOD OF EVALUATION

N/A.

CLOSING STATEMENT

Summer training is a fun and exciting aspect of the Cadet Program. Training is offered in speciality areas that may not be accessible at the corps. Summer training centres are also a place to meet cadets and make new friends from different corps across Canada. It is important to be familiar with the summer training courses offered so cadets may apply for the course that interests them the most.

INSTRUCTOR NOTES/REMARKS

This EO should be conducted prior to the summer training application deadline of the applicable cadet detachment/region.

It is strongly recommended that the summer training application forms (CF 51) be completed during a training session after this EO has been conducted.

Corps may choose to devote two additional complementary training periods to expand this to a session that includes a parent information seminar.

REFERENCES

A0-010 CATO 11-03 D Cdts 2. (2006). *Cadet Program Mandate*. Ottawa, ON: Department of National Defence.

A2-027 CATO 42-01 D Cdts 4. (2005). *Summer Training Directive – Royal Canadian Army Cadets*. Ottawa, ON: Department of National Defence.

A2-031 CATO 40-01 D Cdts. (2003). *Army Cadet Program Outline*. Ottawa, ON: Department of National Defence.



ROYAL CANADIAN ARMY CADETS

RED STAR

INSTRUCTIONAL GUIDE



SECTION 5

EO C207.01 – IDENTIFY THE RANK STRUCTURE OF THE ROYAL CANADIAN SEA AND AIR CADETS

Total Time: 30 min

PREPARATION

PRE-LESSON INSTRUCTIONS

Resources needed for the delivery of this lesson are listed in the lesson specification located in A-CR-CCP-702/PG-001, Chapter 4. Specific uses for said resources are identified throughout the instructional guide within the TP for which they are required.

Review the lesson content and become familiar with the material prior to delivering the lesson.

Copy the handout of ranks located at Annex A for each cadet.

Decide which activity will be completed in TP2 and gather all required materials.

PRE-LESSON ASSIGNMENT

N/A.

APPROACH

An interactive lecture was chosen for TP1 to orient the cadets to the Sea and Air Cadet rank structure, to generate interest and to present basic material.

An in-class activity was chosen for TP2 as it is an interactive way to provoke thought and stimulate interest among cadets.

INTRODUCTION

REVIEW

N/A.

OBJECTIVES

By the end of this lesson the cadet shall be expected to identify the rank structure of the Royal Canadian Sea and Air Cadets.

IMPORTANCE

It is important for cadets to identify the rank structure of the Sea and Air Cadets to better understand the structure of other elements. Knowing the rank structure and insignia will help cadets address other cadets and gain an appreciation for the differences and similarities between Sea, Army and Air Cadets.

Teaching Point 1

Identify the Sea and Air Cadet Rank Structure

Time: 10 min

Method: Interactive Lecture

BACKGROUND KNOWLEDGE



Both Sea and Air Cadet ranks have chevrons and crowns, just like Army Cadets. Sea Cadets also have an anchor and Air Cadets have a propeller on some of their insignia.

Distribute handouts of the cadet rank insignia at Annex A and briefly introduce the cadets to Sea and Air Cadet ranks.

CADET RANK INSIGNIA










ARMY CADET RANKS	SEA CADET RANKS	AIR CADET RANKS
CADET (NO BADGE)	ORDINARY SEAMAN (OS) (NO BADGE)	AIR CADET (AC) (NO BADGE)
PRIVATE (Pte) 	ABLE SEAMAN (AB) 	LEADING AIR CADET (LAC) 
CORPORAL (Cpl) 	LEADING SEAMAN (LS) 	CORPORAL (Cpl) 
MASTER CORPORAL (MCpl) 	MASTER SEAMAN (MS) 	FLIGHT CORPORAL (FCpl) 
SERGEANT (Sgt) 	PETTY OFFICER SECOND CLASS (PO2) 	SERGEANT (Sgt) 
WARRANT OFFICER (WO) 	PETTY OFFICER FIRST CLASS (PO1) 	FLIGHT SERGEANT (FSgt) 
MASTER WARRANT OFFICER (MWO) 	CHIEF PETTY OFFICER SECOND CLASS (CPO2) 	WARRANT OFFICER SECOND CLASS (WO2) 
CHIEF WARRANT OFFICER (CWO) 	CHIEF PETTY OFFICER FIRST CLASS (CPO1) 	WARRANT OFFICER FIRST CLASS (WO1) 

Figure 1 Cadet Ranks

Note. Created by D Cds 3, 2007, Ottawa ON: Department of National Defence.

CONFIRMATION OF TEACHING POINT 1

QUESTIONS

- Q1. What does the rank insignia for a leading seaman look like?
- Q2. What rank has two chevrons, an anchor and a crown?
- Q3. What does the rank insignia for a petty officer first class look like?
- Q4. What does the rank insignia for sergeant look like?
- Q5. What is the highest rank an Air Cadet can obtain?

ANTICIPATED ANSWERS

- A1. Two chevrons and an anchor.
- A2. Master Seaman.
- A3. A crown.
- A4. Three chevrons.
- A5. Warrant Officer First Class (WO1).

Teaching Point 2

Conduct an Activity to Familiarize Cadets With the Sea and Air Cadet Rank Structure

Time: 15 min

Method: In-Class Activity



Conduct only one of the following activities.

ACTIVITY

OBJECTIVE

The objective of this twister activity is to become familiar with Sea and Air Cadet ranks.

RESOURCES

- Sea and Air Cadet rank insignia located at Annex B;
- Actions located at Annex C;
- Tape; and
- Two bags, hats or containers.

ACTIVITY LAYOUT

The floor of ranks must be set up and the bag of actions for the cadets to take must be ready.

To set up the floor of ranks for this twister activity:

1. make two copies of the insignia located at Annex B; and
2. tape the ranks on the floor in a four by seven rectangle, ensuring that the same ranks are not placed together.

To make the bags of actions:

1. make a copy of the actions located at Annex C;
2. cut out the actions;
3. divide the actions into two groups – body parts and ranks;
4. fold the pieces of paper; and
5. place the names of body parts in one bag and the ranks in the other.

ACTIVITY INSTRUCTIONS

1. Divide the cadets into groups of 3–6 cadets.
2. Decide the amount of time each group may have to complete the activity. For example, if there are two groups, each group will have approximately five minutes. If there are three groups, each group will have approximately three to four minutes.
3. If possible, assign two or three cadets to assist in judging.
4. Have the first group place themselves around the floor of ranks.
5. Pick a body part and a rank (action) out of each bag, hat or container and read them aloud (e.g. left hand – able seaman).
6. Have the cadets carry out the action (e.g. put their left hand on an able seaman rank).
7. Replace the paper into the appropriate bag, hat or container.
8. Pick another action, read aloud and have the cadets complete it.
9. If any portion of the cadet's body touches the floor or if they do not complete the proper movement, they are eliminated and must leave the rank floor.
10. Once all the cadets have been eliminated from the first group, start the second group, following the same steps.
11. Continue until all cadets have had a chance to participate in the activity.



If any cadet does not want to participate in this activity, he or she can be a judge.

Have extra tape available in case the ranks slip around on the floor.

SAFETY

- Cadets shall remove their shoes prior to completing this activity.
- This activity shall be stopped immediately if there is any horseplay.

ACTIVITY

OBJECTIVE

The objective of this activity is to become familiar with Sea and Air Cadet ranks.

RESOURCES

- Paper copies of each rank insignia (use as many ranks as the number of cadets in the class. If there are more than fourteen cadets, there can be more than one cadet with the same rank). Ranks are located at Annex B, and
- Tape.

ACTIVITY LAYOUT

Cut out ranks, ensuring there is one for each cadet.

ACTIVITY INSTRUCTIONS

1. Tape a rank to the back of each cadet (the cadet does not get to see the rank that is on their back). Cadets should not talk while this is being done.
2. Have the cadets walk around and ask other cadets yes/no questions to determine what rank they are wearing. For example, the cadet may ask "Do I have two chevrons?" The cadet has to determine from the answers what rank they are. Cadets may not ask any questions that have specific rank names, such as "Am I a Leading Seaman?"
3. There can only be one question asked to each of the other cadets to determine what rank they are. Cadets will move from cadet to cadet until they have determined the rank they are.
4. Once cadets have determined what rank they are, they will gather with any other cadets who are the same rank, if there are any.
5. After three minutes, have the cadets present what rank they think they are based on the information they have received. For example, if a group has determined they have an Air Cadet rank with only two chevrons, they would present themselves as an Air Cadet corporal.

SAFETY

N/A.

ACTIVITY

OBJECTIVE

The objective of this matching activity is to become familiar with Sea and Air Cadet ranks.

RESOURCES

Matching cards of Sea and Air Cadet rank insignia located at Annex D.

ACTIVITY LAYOUT

Cut out one set of matching cards of Sea and Air Cadet ranks for each group of cadets.

ACTIVITY INSTRUCTIONS

1. Divide the cadets into groups of two or three.
2. Distribute a set of matching cards of Sea and Air Cadet ranks to each group.
3. Have the cadets match the title to the badge for each rank.

SAFETY

N/A.

CONFIRMATION OF TEACHING POINT 2

The cadets' participation in the in-class activity will serve as the confirmation of this TP.

END OF LESSON CONFIRMATION

The cadets' participation in the in-class activity in TP2 will serve as the confirmation of this lesson.

CONCLUSION

HOMEWORK/READING/PRACTICE

N/A.

METHOD OF EVALUATION

N/A.

CLOSING STATEMENT

Being able to identify the ranks of the Sea and Air Cadets will make it easier to understand the ranks worn on their uniforms. Cadets may gain an appreciation for the differences and similarities between Sea, Army and Air Cadets.

INSTRUCTOR NOTES/REMARKS

N/A.






















REFERENCES

A1-003 A-CR-005-001/AG-001 D Cdts 3. (Draft). *Royal Canadian Sea Cadets Dress Instructions*. Ottawa, ON: Department of National Defence.

A3-004 CATO 51-02 D Cdts 4. (2007). *Air Cadet Promotions*. Ottawa, ON: Department of National Defence.

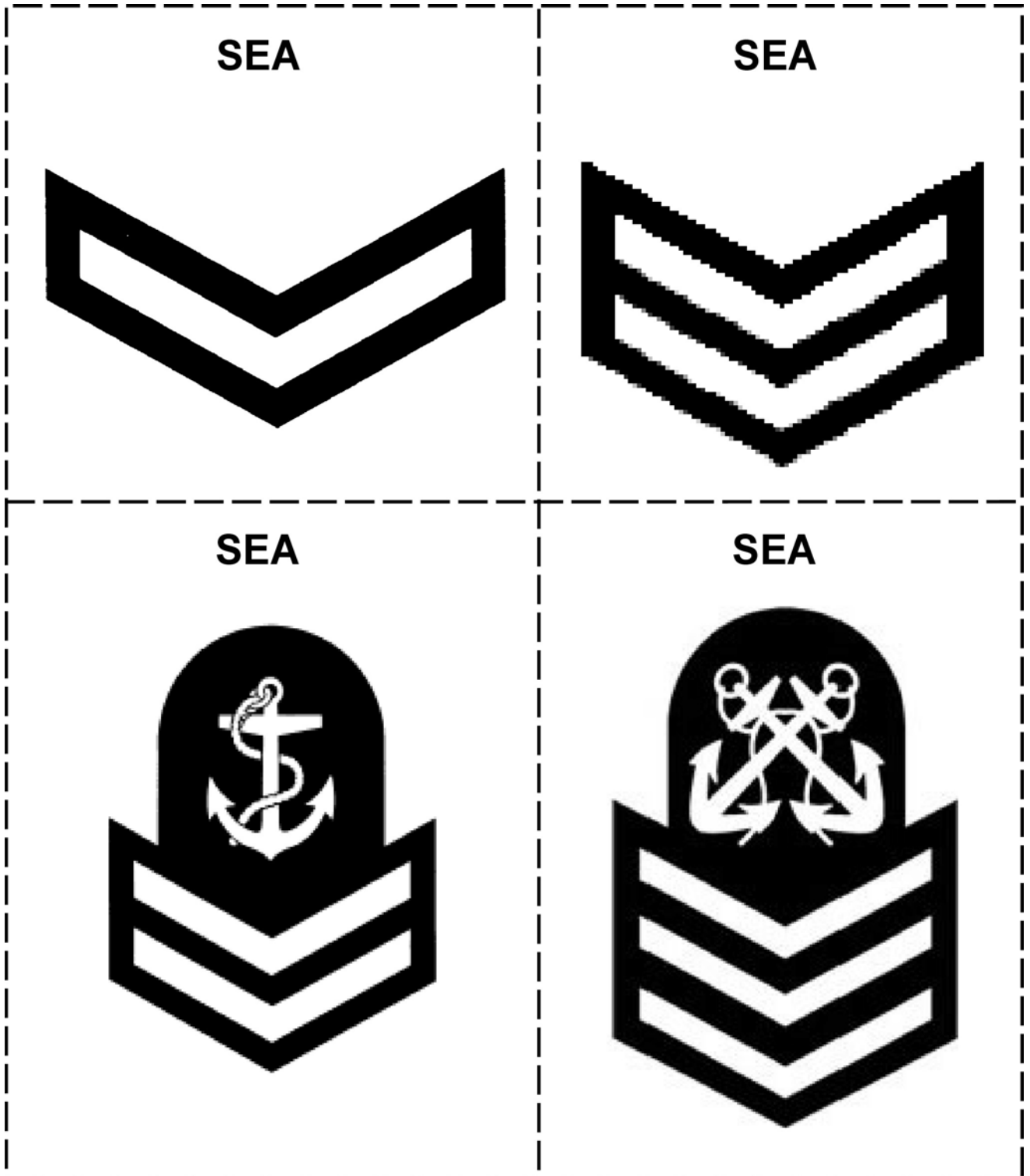
THIS PAGE INTENTIONALLY LEFT BLANK

CADET RANKS

ARMY CADET RANKS	SEA CADET RANKS	AIR CADET RANKS
CADET (NO BADGE)	ORDINARY SEAMAN (OS) (NO BADGE)	AIR CADET (AC) (NO BADGE)
PRIVATE (Pte) 	ABLE SEAMAN (AB) 	LEADING AIR CADET (LAC) 
CORPORAL (Cpl) 	LEADING SEAMAN (LS) 	CORPORAL (Cpl) 
MASTER CORPORAL (MCpl) 	MASTER SEAMAN (MS) 	FLIGHT CORPORAL (FCpl) 
SERGEANT (Sgt) 	PETTY OFFICER SECOND CLASS (PO2) 	SERGEANT (Sgt) 
WARRANT OFFICER (WO) 	PETTY OFFICER FIRST CLASS (PO1) 	FLIGHT SERGEANT (FSgt) 
MASTER WARRANT OFFICER (MWO) 	CHIEF PETTY OFFICER SECOND CLASS (CPO2) 	WARRANT OFFICER SECOND CLASS (WO2) 
CHIEF WARRANT OFFICER (CWO) 	CHIEF PETTY OFFICER FIRST CLASS (CPO1) 	WARRANT OFFICER FIRST CLASS (WO1) 

THIS PAGE INTENTIONALLY LEFT BLANK

INSIGNIA



SEA



SEA



SEA



AIR



AIR



AIR



AIR



AIR



AIR



AIR







ACTIONS






LEFT HAND	CHIEF PETTY OFFICER SECOND CLASS
RIGHT HAND	CHIEF PETTY OFFICER FIRST CLASS
LEFT FOOT	LEADING AIR CADET
RIGHT FOOT	CORPORAL
ABLE SEAMAN	FLIGHT CORPORAL
LEADING SEAMAN	SERGEANT
MASTER SEAMAN	FLIGHT SERGEANT
PETTY OFFICER SECOND CLASS	WARRANT OFFICER SECOND CLASS
PETTY OFFICER FIRST CLASS	WARRANT OFFICER FIRST CLASS

THIS PAGE INTENTIONALLY LEFT BLANK

MEMORY MATCH CARDS

AIR CADET (AC)	AIR CADET (AC)
LEADING AIR CADET (LAC)	
CORPORAL (Cpl)	
FLIGHT CORPORAL (FCpl)	
SERGEANT (Sgt)	

<p>FLIGHT SERGEANT (FSgt)</p>	
<p>WARRANT OFFICER SECOND CLASS (WO2)</p>	
<p>WARRANT OFFICER SECOND CLASS (WO1)</p>	
<p>ORDINARY SEAMAN (OS)</p>	<p>(NO INSIGNA)</p>
<p>ABLE SEAMAN (AB)</p>	

<p>LEADING SEAMAN (LS)</p>	
<p>MASTER SEAMAN (MS)</p>	
<p>PETTY OFFICER SECOND CLASS (PO2)</p>	
<p>PETTY OFFICER FIRST CLASS (PO1)</p>	
<p>CHIEF PETTY OFFICER SECOND CLASS (CPO2)</p>	

**CHIEF PETTY OFFICER FIRST CLASS
(CPO1)**





**COMMON TRAINING
INSTRUCTIONAL GUIDE**



SECTION 6

EO C207.02 – VISIT A LOCAL CADET CORPS OR SQUADRON

Total Time:

90 min

No instructional guide is provided for this EO.

THIS PAGE INTENTIONALLY LEFT BLANK



COMMON TRAINING INSTRUCTIONAL GUIDE



SECTION 1

EO M208.01 – EXECUTE LEFT AND RIGHT TURNS ON THE MARCH

Total Time:

60 min

PREPARATION

PRE-LESSON INSTRUCTIONS

Resources needed for the delivery of this lesson are listed in the lesson specification located in A-CR-CCP-702/PG-001, Chapter 4. Specific uses for said resources are identified throughout the Instructional Guide within the TP for which they are required.

Review the lesson content and become familiar with the material prior to delivering the lesson.

Select the most effective squad formation for the instruction of this lesson. A squad may be in single rank, hollow-square, or semi-circle. Ensure that all cadets are positioned to hear all explanations and see all demonstrations.

Assistant instructors may be required if the squad is broken down into smaller sections for movements that require extra practice.

PRE-LESSON ASSIGNMENT

N/A.

APPROACH

Demonstration and performance was chosen for this lesson as it allows the instructor to explain and demonstrate turning on the march while providing an opportunity for the cadets to practice turning on the march under supervision.



Develop and use a vocabulary of short, concise words to impress on the platoon that the movements must be performed smartly. For example, the words “crack”, “drive”, “seize”, and “grasp” suggest the degree of smartness required. Profanity or personal sarcasm will never be used.

INTRODUCTION

REVIEW

N/A.

OBJECTIVES

By the end of this lesson the cadet shall be expected to execute left and right turns on the march.

IMPORTANCE

It is important for cadets to perform drill movements at a competent level at the cadet corps and at the CSTC. Cadets moving together as one promotes discipline, alertness, precision, pride, steadiness, and cohesion, which in turn helps develop the basis of teamwork.



Proper drill movements should be combined with a professional demeanour throughout the period of instruction.

Check for faults and correct them immediately when they occur.



Each TP is to be conducted as follows:

1. Have cadets fall in, in an effective squad formation (e.g. hollow square).
2. Explain and demonstrate each of the movements given, as time allows.
3. Give cadets time to practice each movement on their own after the demonstration.
4. After all movements have been demonstrated and practiced, give commands and have the cadets perform them as a squad.



Capitalization indicates the words of command for each movement.

When bending the knee, it is raised 15 cm off the ground.

Cadence is to be maintained when completing movements.

Teaching Point 1

Explain, Demonstrate, and Have Cadets Practice Left Turn on the March

Time: 25 min

Method: Demonstration and Performance



Left turn on the march is given as the right foot is forward and on the ground.

LEFT TURN ON THE MARCH

In quick time, on the command LEFT – TURN, the cadets shall:

1. on the first movement, take one half pace forward with the left foot, with the right arm swung forward and the left arm to the rear;
2. on the second movement:
 - a. cut the arms to the side as in the position of attention;
 - b. bend the right knee;

- c. use the momentum of the knee to force the shoulders 90 degrees to the left to face the new direction, while simultaneously pivoting on the ball of the left foot 90 degrees to the left;
 - d. straighten the right leg as in the position of attention;
 - e. shoot the left foot forward one half pace with the toe just clear of the ground;
 - f. keep the body and head up; and
 - g. keep the arms, body, and head steady; and
3. on the third movement, take a half pace with the left foot and continue to march (swinging the arms).



Timing for this movement is “check, pivot, left, right, left”.

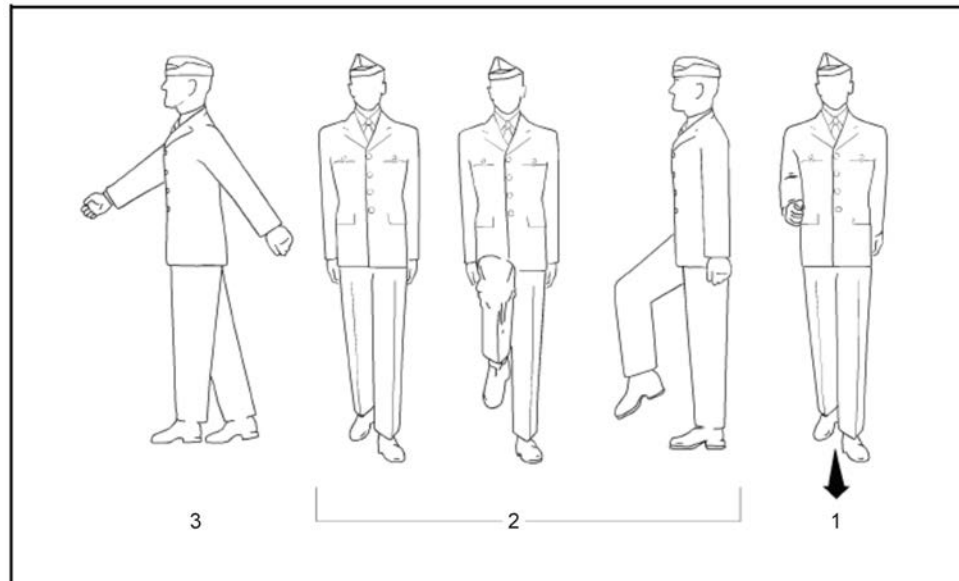


Figure 1 Left Turn in Quick Time

A-PD-201/PT-000, The Canadian Forces Manual of Drill and Ceremonial (p. 3-30)



Figure 2 Left Turn – Movement One

A-PD-201/PT-000 (p. 3-30)

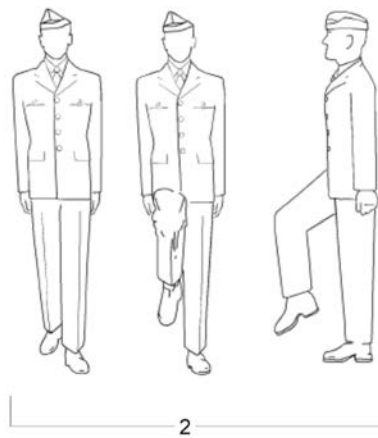
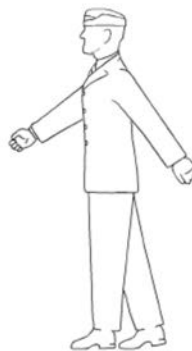


Figure 3 Left Turn – Movement Two

A-PD-201/PT-000 (p. 3-30)



3

Figure 4 Left Turn – Movement Three

A-PD-201/PT-000 (p. 3-30)

CONFIRMATION OF TEACHING POINT 1

Cadets will execute left turns on the march as a squad.

Teaching Point 2

Explain, Demonstrate, and Have Cadets Practice Right Turn on the March

Time: 25 min

Method: Demonstration and Performance



Right turn on the march is given as the left foot is forward and on the ground.

RIGHT TURN ON THE MARCH

In quick time, on the command RIGHT – TURN, the cadet shall:

1. on the first movement, take one half pace forward with the right foot, with the left arm forward and the right arm to the rear;
2. on the second movement:
 - a. cut the arms to the side as in the position of attention;
 - b. bend the left knee;
 - c. use the momentum of the knee to force the shoulders 90 degrees to the right to face the new direction, while simultaneously pivoting on the ball of the right foot 90 degrees to the right;
 - d. straighten the left leg as in the position of attention;
 - e. shoot the right foot forward one half pace with the toe just clear of the ground;
 - f. keep the body and head up; and
 - g. keep the arms, body, and head steady; and
3. on the third movement, take a half pace with the right foot and continuing to march (swinging the arms).



Timing for this movement is “check, pivot, right, left, right”.

CONFIRMATION OF TEACHING POINT 2

Cadets will execute right turns on the march as a squad.

END OF LESSON CONFIRMATION

The confirmation of this lesson shall consist of the cadets, as a squad, executing left and right turns on the march and shall emphasize any movements that cadets had difficulty with during the class.

Practice the complete movements with:

- the **instructor** calling the time;
- the **squad** calling the time; and
- the squad **judging** the time.

CONCLUSION

HOMEWORK/READING/PRACTICE

N/A.

METHOD OF EVALUATION

N/A.

CLOSING STATEMENT

Drill develops many qualities through self-discipline and practice. Drill that is well-rehearsed, closely supervised and precise is an exercise in obedience and alertness that creates teamwork among members.

INSTRUCTOR NOTES/REMARKS

N/A.

REFERENCES

A0-002 A-PD-201-000/PT-000 Directorate of History and Heritage 3-2. (2001). *The Canadian Forces Manual of Drill and Ceremonial*. Ottawa, ON: The Department of National Defence.



COMMON TRAINING INSTRUCTIONAL GUIDE



SECTION 2

EO M208.02 – FORM SINGLE FILE FROM THE HALT

Total Time:

30 min

PREPARATION

PRE-LESSON INSTRUCTIONS

Resources needed for the delivery of this lesson are listed in the lesson specification located in A-CR-CCP-702/PG-001, Chapter 4. Specific uses for said resources are identified throughout the Instructional Guide within the TP for which they are required.

Review the lesson content and become familiar with the material prior to delivering the lesson.

Select the most effective squad formation for the instruction of this lesson. A squad may be in single rank, hollow-square, or semi-circle. Ensure that all cadets are positioned to hear all explanations and see all demonstrations.

Assistant instructors may be required if the squad is broken down into smaller sections for movements that require extra practice.

PRE-LESSON ASSIGNMENT

N/A.

APPROACH

Demonstration and performance was chosen for this lesson as it allows the instructor to explain and demonstrate the skill the cadet is expected to acquire while providing an opportunity for the cadets to practice forming single file from the halt under supervision.



Develop and use a vocabulary of short, concise words to impress on the platoon that the movements must be performed smartly. For example, the words “crack”, “drive”, “seize”, and “grasp” suggest the degree of smartness required. Profanity or personal sarcasm will never be used.

INTRODUCTION

REVIEW

N/A.

OBJECTIVES

By the end of this lesson the cadet shall be expected to form single file from the halt.

IMPORTANCE

It is important for cadets to perform drill movements at a competent level at the cadet corps and at the CSTC. Cadets moving together as one promotes discipline, alertness, precision, pride, steadiness, and cohesion, which in turn helps develop the basis of teamwork.



Proper drill movements should be combined with a professional demeanour throughout the period of instruction.

Check for faults and correct them immediately when they occur.



This lesson is not broken down into movements. Demonstrate and allow time for the cadets to practice, in a variety of positions.



Capitalization indicates the words of command for each movement.

Cadence is to be maintained when completing these movements.

Teaching Point 1

Explain, Demonstrate, and Have Cadets Practice Forming Single File From the Halt as a Squad in Threes

Time: 15 min

Method: Demonstration and Performance

FORM SINGLE FILE FROM THE HALT AS A SQUAD IN THREES

On the command SINGLE FILE FROM THE LEFT (RIGHT), QUICK – MARCH, the movement will be completed by:

1. the directing flank marching off in single file in quick time; and
2. the remaining cadets marking time. The markers of the other two ranks executing a left (right) incline and leading off when the file on their left (right) is clear.

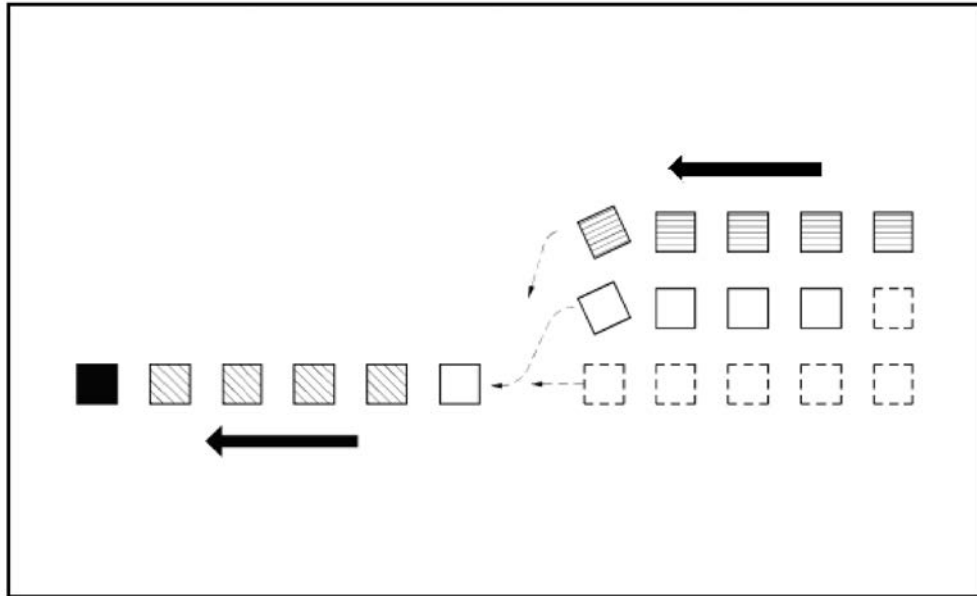


Figure 1 Squad in Threes Forming Single File

A-PD-201-000/PT-000 (p. 3-30)

CONFIRMATION OF TEACHING POINT 1

Practice the movement in squad formation. Cadets should have the opportunity to practice the movement from different positions in the squad.

Teaching Point 2

Explain, Demonstrate, and Have Cadets Practice Forming Single File From the Halt as a Squad in Line

Time: 10 min

Method: Demonstration and Performance

FORM SINGLE FILE FROM THE HALT AS A SQUAD IN LINE

On the command SINGLE FILE FROM THE LEFT (RIGHT), QUICK – MARCH, the movement will be completed by:

1. the file on the directing flank marching forward in single file in quick time; and
2. the remaining cadets marking time. The markers of the other two ranks directing the remaining cadets by wheeling in single file, following the file on their left (right) when clear.

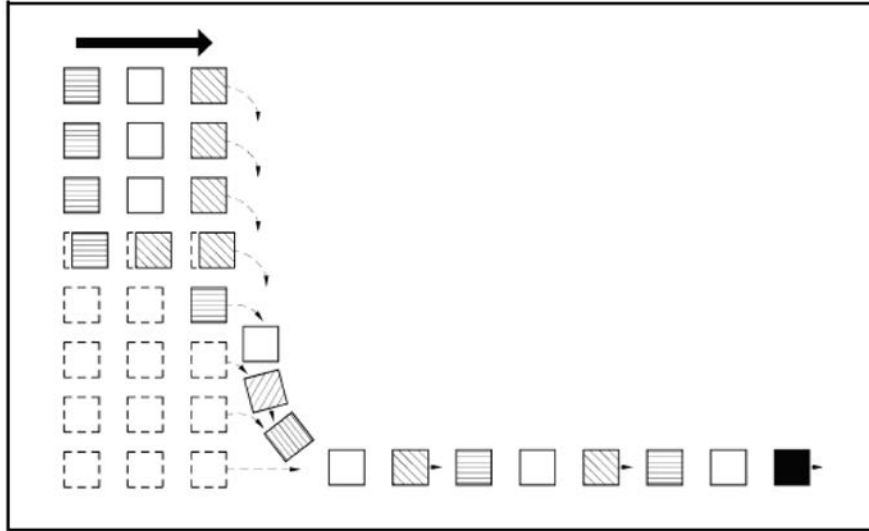


Figure 2 Squad in Line Forming Single File

A-PD-201-000/PT-000 (p. 3-30)

CONFIRMATION OF TEACHING POINT 2

Practice the movement in squad formation. Cadets should have the opportunity to practice the movement from different positions in the squad.

END OF LESSON CONFIRMATION

The confirmation of this lesson shall consist of the cadets, as a squad, forming single file from the halt as a squad in threes and in line, and shall emphasize any aspects the cadets experienced difficulty with during the class.

CONCLUSION

HOMEWORK/READING/PRACTICE

N/A.

METHOD OF EVALUATION

N/A.

CLOSING STATEMENT

Drill develops many qualities through self-discipline and practice. Drill that is well-rehearsed, closely supervised and precise is an exercise in obedience and alertness that creates teamwork among members.

INSTRUCTOR NOTES/REMARKS

N/A.

REFERENCES

A0-002 A-PD-201-000/PT-000 Directorate of History and Heritage 3-2. (2001). *The Canadian Forces Manual of Drill and Ceremonial*. Ottawa, ON: The Department of National Defence.

THIS PAGE INTENTIONALLY LEFT BLANK



**COMMON TRAINING
INSTRUCTIONAL GUIDE**



SECTION 3

EO C208.01 – PRACTICE CEREMONIAL DRILL AS A REVIEW

Total Time:

60 min

There is no Instructional Guide provided for this EO. Refer to A-PD-201-000/PT-001.

THIS PAGE INTENTIONALLY LEFT BLANK



**COMMON TRAINING
INSTRUCTIONAL GUIDE**



SECTION 4

EO C208.02 – EXECUTE DRILL WITH ARMS

Total Time:

240 min

There is no Instructional Guide provided for this EO. Refer to A-CR-CCP-053/PT-001, *Royal Canadian Sea Cadets Manual of Drill and Ceremonial*.

THIS PAGE INTENTIONALLY LEFT BLANK



COMMON TRAINING INSTRUCTIONAL GUIDE



SECTION 1

EO C211.01 – IDENTIFY CIVILIAN BIATHLON OPPORTUNITIES

Total Time:

30 min

PREPARATION

PRE-LESSON INSTRUCTIONS

Resources needed for the delivery of this lesson are listed in the lesson specification located in A-CR-CCP-702/PG-001, Chapter 4. Specific uses for said resources are identified throughout the Instructional Guide within the TP for which they are required.

Review the lesson content and become familiar with the material prior to delivering the lesson.

PRE-LESSON ASSIGNMENT

N/A.

APPROACH

An interactive lecture was chosen for this lesson to orient the cadets to civilian biathlon opportunities and to generate interest.

INTRODUCTION

REVIEW

N/A.

OBJECTIVES

By the end of this lesson the cadet shall be expected to identify civilian biathlon opportunities.

IMPORTANCE

It is important for cadets to identify civilian biathlon opportunities because they may choose to pursue the sport of biathlon outside the Cadet Program.

Teaching Point 1

Introduce Local, Provincial/Territorial, National, and International Biathlon Training Opportunities

Time: 10 min

Method: Interactive Lecture

There are many training opportunities for biathletes at the local, provincial/territorial, national, and international levels. These training opportunities include clinics and camps ranging from weekend programs for basic and

intermediate training, to year round advanced training. Training development clinics offered include coaching, race opportunities and training programs for all ranges in skill levels from the beginner to the advanced competitor training at the national team level.

LOCAL

Local ski resorts/clubs may offer a selection of biathlon programs. Biathlon Bears is a community coaching program offered across Canada. The Biathlon Bears program is open to novices and the training is tailored to the athlete's skill level. This program offers training to develop both skiing and marksmanship skills. There is a ranking structure in the program. As skills are learned and mastered, the biathlete progresses to the next Biathlon Bear level.



For examples of local biathlon training opportunities, contact the local ski resort/club.

PROVINCIAL/TERRITORIAL

Divisions of Biathlon Canada are located within many of the provinces/territories. These division offices run training and offer support to the local resorts/clubs.



For examples of provincial/territorial biathlon training opportunities, contact the division office/Website.

NATIONAL

Biathlon Canada is the governing body for the sport of biathlon within Canada. There are two national biathlon training centres located in Canmore, Alberta and Valcartier, Quebec. These centres offer training to the national biathlon teams.



For examples of national biathlon training opportunities, contact Biathlon Canada (www.biathloncanada.ca).

INTERNATIONAL

The International Biathlon Union (IBU) is the governing body for the sport of biathlon internationally. There are biathlon training centres located across the globe. National training centres offer training to athletes who will be competing internationally. The international training centres allow high performance biathletes to train in various geographical regions where the elevation above sea level, and the changes in the oxygen density, create different training demands on the biathlete. This allows the biathlete to adapt to the environmental conditions prior to the competition, thus increasing their expected performance outcome.



For examples of international biathlon training opportunities, contact the International Biathlon Union (www.biathlonworld.com).

CONFIRMATION OF TEACHING POINT 1

QUESTIONS

- Q1. Who offers biathlon training at the local level?
- Q2. Where are the two Canadian national biathlon training centres located?
- Q3. What is the name of the organization that governs biathlon internationally?

ANTICIPATED ANSWERS

- A1. Local ski resorts/clubs.
- A2. Canmore, Alberta and Valcartier, Quebec.
- A3. The International Biathlon Union (IBU).

Teaching Point 2

Introduce Local, Provincial/Territorial, National, and International Competitive Biathlon Opportunities

Time: 10 min

Method: Interactive Lecture

LOCAL

Local ski resorts/clubs offer competitive events across Canada from beginner to advanced racing opportunities.



For examples of local competitive biathlon opportunities, contact the local ski resort/club.

PROVINCIAL/TERRITORIAL

The division offices located within many Canadian provinces/territories offer regional competitive biathlon events. Many of these events require advancement through a ranking process. There are race qualifications that the competitors must meet, which may include, but are not limited to, age, gender, resort/club or team standings, or previous race standings (if in a series of races). Not all races lead to a higher level, they may only be a participatory race.



For examples of provincial/territorial competitive biathlon opportunities, contact the division office/Website.

NATIONAL

National competitive biathlon events offered through Biathlon Canada include:

- Canadian Championships; and
- Canada Games.



For examples of national competitive biathlon opportunities, contact Biathlon Canada (www.biathloncanada.ca).

INTERNATIONAL

International competitive biathlon events offered in conjunction with the IBU include:

- Olympic Games;
- World Cup;
- World Championship;
- European Cup; and
- Europa Cup.



For examples of international competitive biathlon opportunities, contact the International Biathlon Union (www.biathlonworld.com).

CONFIRMATION OF TEACHING POINT 2

QUESTIONS

- Q1. What types of criteria must a biathlete meet to proceed to a provincial/territorial competition?
- Q2. Name one national competitive biathlon event.
- Q3. Name two international competitive biathlon events.

ANTICIPATED ANSWERS

- A1. Age, gender, resort/club or team standings, or previous race standings (if in a series of races).
- A2. National competitive biathlon events offered through Biathlon Canada include:
 - Canadian Championships; and
 - Canada Games.

A3. International competitive biathlon events offered in conjunction with the IBU include:

- Olympic Games;
- World Cup;
- World Championship;
- European Cup; and
- Europa Cup.

Teaching Point 3

Identify Famous Biathletes Who Were Introduced to the Sport Through the Canadian Cadet Program

Time: 5 min

Method: Interactive Lecture

Biathletes who were introduced to the sport through the Canadian Cadet Program have seen Olympic glory. There are numerous ex-cadets who are successful on both the national and international scene. These biathletes include Myriam Bédard, Nikki Keddie, Martine Albert, and Jean-Philippe Le Guellec.

Jean-Philippe Le Guellec, from Shannon, Quebec, was introduced to the sport of biathlon through the Air Cadet Program. He won three gold medals at the 2007 Biathlon Canada Championships in Charlo, New Brunswick and participated in the 2006 Winter Olympics in Torino, Italy.

Myriam Bédard, from Ancienne-Lorrette, Quebec, was introduced to the sport of biathlon through the Army Cadet Program. She was the first Canadian athlete to win a World Cup biathlon event in 1991, and the first North American athlete to win an Olympic medal in the 1992 Winter Games at Albertville, France. She also won two gold medals at the 1994 Winter Olympics in Lillehammer, Norway. These were the first Olympic biathlon gold medals won by a North American biathlete. On 4 November 1998, Myriam Bédard was inducted into Canada's Sports Hall of Fame.

CONFIRMATION OF TEACHING POINT 3

QUESTIONS

- Q1. Name two famous biathletes who were introduced to the sport through the Canadian Cadet Program.
- Q2. How many gold medals have been won by Jean-Philippe Le Guellec?
- Q3. Myriam Bédard was introduced to the sport of biathlon through which element of the Cadet Program?

ANTICIPATED ANSWERS

- A1. Myriam Bédard, Nikki Keddie, Martine Albert, and Jean-Philippe Le Guellec.
- A2. Three.
- A3. Army cadets.

END OF LESSON CONFIRMATION

QUESTIONS

- Q1. What is the name of the training program offered at many ski resorts/clubs in Canada?
- Q2. What is the name of the organization that governs the sport of biathlon in Canada?
- Q3. Jean-Philippe Le Guellec was introduced to the sport of biathlon through which element of the Cadet Program?

ANTICIPATED ANSWERS

- A1. Biathlon Bears.
- A2. Biathlon Canada.
- A3. Air cadets.

CONCLUSION

HOMEWORK/READING/PRACTICE

N/A.

METHOD OF EVALUATION

N/A.

CLOSING STATEMENT

Biathlon is a fun and exciting activity that requires personal discipline. For those who choose to pursue this sport, there are numerous civilian training and competitive opportunities available at the local, provincial/territorial, national, and international levels.

INSTRUCTOR NOTES/REMARKS

N/A.

REFERENCES

A0-042 Regional Cadet Support Unit (Central). (2007). *Cadet Marksmanship and Firearms Safety Program*. Retrieved 18 April 2007, from http://www.central.cadets.ca/events/biath_cadetmarksman_e.html.

C0-082 Biathlon Canada. (2007). *Biathlon Canada*. Retrieved 12 February 2007, from <http://www.biathloncanada.ca>.

C0-148 International Biathlon Union. (2007). *International Biathlon Union*. Retrieved 18 April 2007, from <http://www.biathlonworld.com>.

C0-149 Biathlon Canada. (2005). *Biathlon Bears: Community Coaching*. Ottawa, Ontario: Biathlon Canada.

C0-153 Library and Archives Canada. (2000). *Myriam Bédard*. Retrieved 30 April 2007, from <http://www.collectionscanada.ca/women/002026-223-e.html>.



COMMON TRAINING INSTRUCTIONAL GUIDE



SECTION 2

EO C211.02 – RUN ON ALTERNATING TERRAIN

Total Time: 30 min

PREPARATION

PRE-LESSON INSTRUCTIONS

Resources needed for the delivery of this lesson are listed in the lesson specification located in A-CR-CCP-702/PG-001, Chapter 4. Specific uses for said resources are identified throughout the Instructional Guide within the TP for which they are required.

Review the lesson content and become familiar with the material prior to delivering the lesson.

Ensure a first aid station is set up and a first aid attendant is available during the practical activities.

Photocopy the sample running schedule located at Annex B for each cadet.

Set up a running route on alternating terrain, depending on geographical location.

PRE-LESSON ASSIGNMENT

N/A.

APPROACH

An interactive lecture was chosen for TP1 and TP5 to introduce cadets to running techniques on alternating terrain and on how to implement a running program.

A practical activity was chosen for TP2 to TP4 as it is an interactive way to introduce the cadets to running on alternating terrain in a safe and controlled environment.

INTRODUCTION

REVIEW

Review EO C111.02 (Run Wind Sprints), to include:

- preparing for summer biathlon activities; and
- running techniques.

OBJECTIVES

By the end of this lesson the cadet shall have run on alternating terrain.

IMPORTANCE

It is important for cadets to run on alternating terrain because it will be useful when participating in summer biathlon activities.

Teaching Point 1

Describe Running Techniques for Alternating Terrain

Time: 5 min

Method: Interactive Lecture

POSTURE/BODY ALIGNMENT

Uphill Running

On gradual inclines, runners should run a bit harder than when on level terrain. On steep inclines runners should lift the knees and push off with every step.

Downhill Running

When running downhill the runner should lean into the hill and use short, quick strides.

FOOT POSITIONING

Distance runners should land on their heels or mid-foot and roll forward to the toe while running. Running up on the toes is the method used by sprinters, and if used for distance running, may cause the shins and calves to become tight.

ENDURANCE

To increase endurance, runners should increase distance, duration, and level of difficulty of their runs.

CONFIRMATION OF TEACHING POINT 1

QUESTIONS

- Q1. How should your foot strike the ground when running distances?
- Q2. What technique should be used when running up steep inclines?
- Q3. What technique should be used when running downhill?

ANTICIPATED ANSWERS

- A1. Distance runners should land on their heels or mid-foot and roll forward to the toe.
- A2. Lift the knees and push off with every step.
- A3. Lean into the hill and use short, quick strides.

Teaching Point 2**Conduct a Warm-up Session Composed of Light Cardiovascular Exercises**

Time: 5 min

Method: Practical Activity



The following information will be explained to the cadets during the warm-up activity.

PURPOSE OF A WARM-UP

A warm-up is composed of stretches and light cardiovascular exercises designed to:

- stretch the muscles;
- gradually increase respiratory action and heart rate;
- expand the muscles' capillaries to accommodate the increase in blood circulation which occurs during physical activity; and
- raise the muscle temperature to facilitate reactions in muscle tissue.

GUIDELINES FOR STRETCHING

The following guidelines should be followed while stretching to prepare for physical activity and to help prevent injury:

- Stretch all major muscle groups, including the back, chest, legs, and shoulders.
- Never bounce while stretching.
- Hold each stretch for 10 to 30 seconds to let the muscles release fully.
- Repeat each stretch two to three times.
- When holding a stretch, support the limb at the joint.
- Static stretching, which is stretching a muscle and holding it in position without discomfort for 10 to 30 seconds, is considered the safest method.
- Stretching helps to relax the muscles and improve flexibility, which is the range of motion in the joints.
- As a guide, allow 10 minutes to warm-up for every hour of physical activity.



The stretches chosen should focus on the areas of the body that will be used the most during the running activity.

ACTIVITY

OBJECTIVE

The objective of this warm-up activity is to stretch the muscles and perform light cardiovascular exercises to prepare the body for physical activity and to help prevent injuries.

RESOURCES

N/A.

ACTIVITY LAYOUT

N/A.

ACTIVITY INSTRUCTIONS

- Arrange the cadets in either a warm-up circle or in rows (as illustrated in Figures 1 and 2).

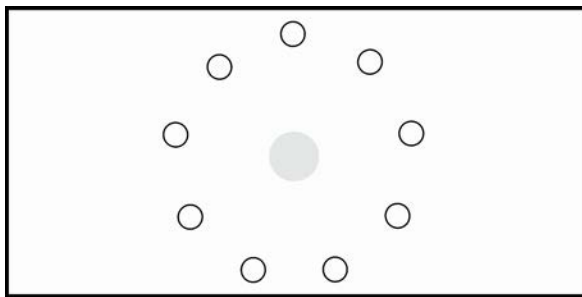


Figure 1 Instructor in the Centre of a Warm-up Circle
D Cdts 3, 2006, Ottawa, ON: Department of National Defence

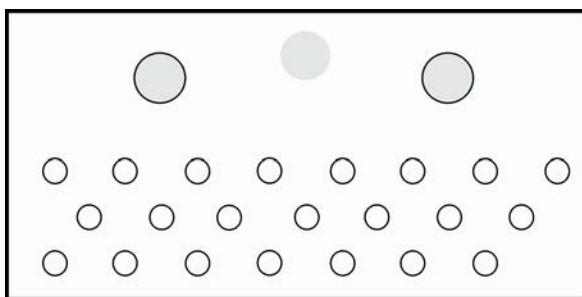


Figure 2 Instructor at the Front With Two Assistant Instructors
D Cdts 3, 2006, Ottawa, ON: Department of National Defence

- Demonstrate before having the cadets attempt each stretch/light cardiovascular exercise.
- Assistant instructors can help demonstrate the exercises and ensure the cadets are performing them correctly.
- Have cadets perform each stretch/light cardiovascular exercise.



Light cardiovascular activities should be done to warm-up the muscles prior to stretching to avoid injury to or tearing of the muscles. For example, running on the spot for 30 seconds or performing jumping jacks should be performed prior to conducting the stretching activities located at Annex A.

SAFETY

- Ensure there are at least two arm lengths between the cadets so they can move freely.
- Ensure the cadets perform the stretches and light cardiovascular exercises in a safe manner, following the guidelines for stretching listed in this TP.

CONFIRMATION OF TEACHING POINT 2

The cadets' participation in the warm-up will serve as the confirmation of this TP.

Teaching Point 3

Supervise While the Cadets Run on Alternating Terrain

Time: 5 min

Method: Practical Activity

ACTIVITY

OBJECTIVE

The objective of this activity is to have the cadets run on alternating terrain.

RESOURCES

- Area with alternating terrain that is large enough to conduct a run.
- A whistle.

ACTIVITY LAYOUT

N/A.

ACTIVITY INSTRUCTIONS

- Have the cadets run at a comfortable pace.
- Ensure that the run includes some uphill and downhill inclines, and that the cadets use the techniques described in TP1.

SAFETY

- Ensure a designated first aider and first aid kit are available.
 - Ensure water is available for the cadets after they complete the run.
-

CONFIRMATION OF TEACHING POINT 3

The cadets' participation in the activity will serve as the confirmation of this TP.

Teaching Point 4

Conduct a Cool-down Session Composed of Light Cardiovascular Exercises

Time: 5 min

Method: Practical Activity



The following information will be explained to the cadets during the cool-down activity.

PURPOSE OF A COOL-DOWN

A cool-down is composed of stretches and light cardiovascular exercises designed to:

- allow the body time to slowly recover from physical activity and to help prevent injury;
- prepare the respiratory system to return to its normal state; and
- stretch the muscles to help relax and restore them to their resting length.



The stretches chosen should focus on the areas of the body that were used the most during the running activity.

ACTIVITY

OBJECTIVE

The objective of the cool-down is to stretch the muscles and perform light cardiovascular exercises that allow the body time to recover from physical activity, and to prevent injury.

RESOURCES

N/A.

ACTIVITY LAYOUT

N/A.

ACTIVITY INSTRUCTIONS

- Arrange the cadets in either a warm-up circle or in rows (as illustrated in Figures 1 and 2).
- Demonstrate before having the cadets attempt each stretch/light cardiovascular exercise.
- Assistant instructors can help demonstrate the movements and ensure the cadets are performing them correctly.
- Have cadets perform each stretch/light cardiovascular exercise.

SAFETY

- Ensure there are at least two arm lengths between the cadets so they can move freely.
- Ensure the cadets perform the stretches and light cardiovascular exercises in a safe manner, following the guidelines for stretching listed in TP2.

CONFIRMATION OF TEACHING POINT 4

The cadets' participation in the cool-down will serve as the confirmation of this TP.

Teaching Point 5**Describe How To Create and Implement a Running Schedule**

Time: 5 min

Method: Interactive Lecture

PURPOSE OF RUNNING SCHEDULE

A running schedule will help a new runner ease into a training plan, or guide an experienced runner to increase their endurance. The schedule should allow the runner to gradually increase intensity at a comfortable pace. A sample running schedule is located at Annex B.

GUIDELINES FOR RUNNING SCHEDULES

The following guidelines should be followed when creating a running schedule to increase endurance and to help prevent injury:

- If there is no running background, begin with eight consecutive days of walking (20 minutes the first four days, and 30 minutes the remaining four days).
- If there is a running background, begin by walking/running four times a week for 20 to 30 min (e.g., 2 min running/4 min walking, repeat this five times for a 30 min workout).
- Increase the running time, as fitness level allows until the cadet is able to run for 30 minutes continuously.
- The distance run in 30 minutes will increase as fitness level improves, allowing for the run to be calculated based on distance instead of time.
- Change the terrain as fitness level improves.

CONFIRMATION OF TEACHING POINT 5**QUESTIONS**

- Q1. What is the purpose of a running schedule?
- Q2. What should a person with no running background begin with?
- Q3. What will increase as fitness level improves?

ANTICIPATED ANSWERS

- A1. A running schedule will help a new runner ease into a training plan, or guide an experienced runner to increase their endurance.
- A2. Begin with eight consecutive days of walking.
- A3. The distance that can be run in 30 minutes will increase as fitness level improves.

END OF LESSON CONFIRMATION

The cadet's participation in the activity in TP3 will serve as the confirmation of this lesson.

CONCLUSION

HOMEWORK/READING/PRACTICE

N/A.

METHOD OF EVALUATION

N/A.

CLOSING STATEMENT

Running on alternating terrain will help to increase endurance, which will be useful when participating in summer biathlon activities.

INSTRUCTOR NOTES/REMARKS

N/A.

REFERENCES

C0-002 (ISBN 0-88962-630-8) LeBlanc, J. & Dickson, L. (1997). *Straight Talk About Children and Sport: Advice for Parents, Coaches, and Teachers*. Oakville, ON and Buffalo, NY: Mosaic Press.

C0-057 Martha Jefferson Hospital. (2001). *Warm-ups*. Retrieved 16 October 2006, from <http://www.marthajefferson.org/warmup.php>.

C0-058 Webb Physiotherapists Inc. (ND). *Running Exercises*. Retrieved 26 October 2006 from <http://www.physioline.co.za/conditions/article.asp?id=46>.

C0-059 Webb Physiotherapists Inc. (ND). *Exercise Programme for Squash, Tennis, Softball, Handball*. Retrieved 25 October 2006 from <http://www.physioline.co.za/conditions/article.asp?id=49>.

C0-060 Impacto Protective Products Inc. (1998). *Exercises*. Retrieved 25 October 2006, from <http://www.2protect.com/work3b.htm>.

C0-061 City of Saskatoon, Community Services Department. (ND). *Stretch Your Limits: A Smart Guide To Stretching for Fitness*. Retrieved 26 October 2006, from <http://in-motion.ca/walkingworkout/plan/flexibility/>.

C0-080 Cool Running. (2007). *Fitness and Performance*. Retrieved 12 February 2007, from http://www.coolrunning.com/engine/2/2_3/181.shtml.

C0-089 (ISBN 0-936070-22-6) Anderson, B. (2000). *Stretching: 20th Anniversary* (Rev. ed.). Bolinas, CA: Shelter Publications, Inc.

C0-146 Will-Weber, M. (2006). *Runner's World: Beginner's: Training: First Steps*. Retrieved 18 April 2007, from <http://www.runnersworld.com/article/printer/1,7124,s6-380-381-386-678-0,00.html>.

C0-154 Hansen, B. (1999). *Moving on the Spot: Fun and Physical Activity: A Collection of 5-Minute Stretch and Movement Sessions*. Retrieved 26 October 2006, from <http://lin.ca/resource/html/dn3.htm#11>.

SAMPLE STRETCHES

NECK

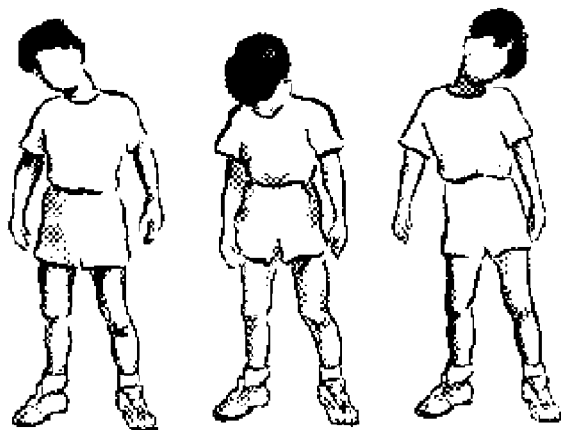


Figure A-1 Neck Stretch

Moving on the Spot: A Collection of 5-Minute Stretch and Movement Sessions, by B. Hanson, 1999, Toronto, Ontario: Toronto Public Health. Retrieved 26 October 2006, from <http://www.lin.ca/resource/html/dn3.htm#1>

Slowly roll your head across your chest from shoulder to shoulder. Do not roll your head backwards.

SHOULDERS



Figure A-2 Shoulder Push

Moving on the Spot: A Collection of 5-Minute Stretch and Movement Sessions, by B. Hanson, 1999, Toronto, Ontario: Toronto Public Health. Retrieved 26 October 2006, from <http://www.lin.ca/resource/html/dn3.htm#1>

Stand and extend your arms behind you, interlocking your fingers. Push up and back with your shoulders.

Hold this position for a minimum of 10 seconds.

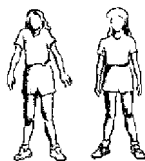


Figure A-3 Shoulder Shrug

Moving on the Spot: A Collection of 5-Minute Stretch and Movement Sessions, by B. Hanson, 1999, Toronto, Ontario: Toronto Public Health. Retrieved 26 October 2006, from <http://www.lin.ca/resource/html/dn3.htm#1>

Stand and raise your shoulders as high as possible and then lower your shoulders, stretching your neck up.

Pull your shoulders back as far as possible and then round your shoulders forward by pushing your shoulders forward as far as possible.

Hold each position for a minimum of 10 seconds.



Figure A-4 Arm Circles

Warm Ups, by Martha Jefferson Hospital, Copyright 2001 by Martha Jefferson Hospital. Retrieved 26 October 2006, from <http://www.marthajefferson.org/warmup.php>

Hold your arms straight out, palms up. Make small circles with your arms, gradually increasing the size.
Reverse the direction of your circles.



Figure A-5 Shoulder Stretch

Smart Start: A Flexible Way to Get Fit. Retrieved 26 October 2006, from <http://www.in-motion.ca/walkingworkout/plan/flexibility/>

Either standing or sitting, take your right arm in your left hand and bring it across your chest, supporting the joint by holding it behind the elbow. Pull the elbow lightly towards your chest. You should feel the stretch in your right shoulder.

Hold this position for a minimum of 10 seconds and repeat on the opposite side.

ARMS



Figure A-6 Wrist Rotations

Exercises. Copyright 1998 by Impacto Protective Products Inc. Retrieved 26 October 2006, from <http://www.2protect.com/home.htm>

Rotate your hands in circular motions at the wrist.
Change direction and repeat on both sides.



Figure A-7 Triceps Stretch

Smart Start: A Flexible Way to Get Fit. Retrieved 26 October 2006, from <http://www.in-motion.ca/walkingworkout/plan/flexibility/>

Stand and bring your right arm over your head, bent at the elbow. Use your left hand to gently pull your arm down.

Hold this position for a minimum of 10 seconds and repeat on the opposite side.



Figure A-8 Forearm Stretch

Exercise Programme for Squash, Tennis, Softball, Handball. Retrieved 26 October 2006, from <http://www.physionline.co.za/conditions/article.asp?id=49>

In a kneeling position, place your hands on the floor in front of you with your fingers pointing toward your knees, and your thumbs pointing out. Keeping your hands flat on the floor, lean back. Hold this position for a minimum of 10 seconds.

CHEST AND ABDOMINALS



Figure A-9 Chest Stretch

Smart Start: A Flexible Way to Get Fit. Retrieved 26 October 2006, from <http://www.in-motion.ca/walkingworkout/plan/flexibility/>

Stand facing a wall. With your right arm bent and your elbow at shoulder height, place your palm against the wall. Turn your body away from your right arm. You should feel the stretch on the front side of your armpit and across the front of your chest.

Hold this position for a minimum of 10 seconds and repeat on the opposite side.



Figure A-10 Side Stretch

Moving on the Spot: A Collection of 5-Minute Stretch and Movement Sessions, by B. Hanson, 1999, Toronto, Ontario: Toronto Public Health. Retrieved 26 October 2006, from <http://www.lin.ca/resource/html/dn3.htm#1>

Stand with your left arm up over your head. Bend at the waist towards the right side of your body.

Hold this position for a minimum of 10 seconds and repeat on the opposite side.

BACK



Figure A-11 Lower Back Stretch

Smart Start: A Flexible Way to Get Fit. Retrieved 26 October 2006, from <http://www.in-motion.ca/walkingworkout/plan/flexibility/>

Lie on your back and bring your knees toward your chest. Grasp the back of your knees. Hold this position for a minimum of 10 seconds.

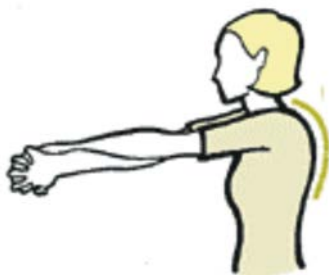


Figure A-12 Upper Back Stretch

Smart Start: A Flexible Way to Get Fit. Retrieved 26 October 2006, from <http://www.in-motion.ca/walkingworkout/plan/flexibility/>

Extend your arms straight in front of you at shoulder height crossing one arm over the other. With the palms facing each other, intertwine your fingers and press out through your arms. Let your chin fall to your chest as you exhale. You should feel the stretch in the upper back.

Hold this position for a minimum of 10 seconds and repeat on the opposite side.

LEGS



Figure A-13 Hamstring Stretch

Smart Start: A Flexible Way to Get Fit. Retrieved 26 October 2006, from <http://www.in-motion.ca/walkingworkout/plan/flexibility/>

Lie flat on the floor with your knees bent and your back flat on the floor. Slowly raise and straighten one leg, grasping it behind your thigh with both hands. Hold this position for a minimum of 10 seconds.



Figure A-14 Inner Thigh Stretch

Smart Start: A Flexible Way to Get Fit. Retrieved 26 October 2006, from <http://www.in-motion.ca/walkingworkout/plan/flexibility/>

Sit on the floor with your knees bent and the soles of your feet together. Grab your toes and pull yourself forward while keeping your back and neck straight.

Hold this position for a minimum of 10 seconds.

Grab your ankles and push your knees down toward the floor with your elbows.

Hold this position for a minimum of 10 seconds.



Figure A-15 Hip Flexor

Smart Start: A Flexible Way to Get Fit. Retrieved 26 October 2006, from <http://www.in-motion.ca/walkingworkout/plan/flexibility/>

Kneel on your right knee. Position your left foot in front of you, bending your knee and placing your left hand on that leg for stability. Keep your back straight and abdominal muscles tight. Lean forward, shifting more body weight onto your front leg. You should feel the stretch in the front of your hip and the thigh of the leg you are kneeling on. Cushion your kneecap with a folded towel if necessary.

Hold this position for a minimum of 10 seconds and repeat on the opposite side.

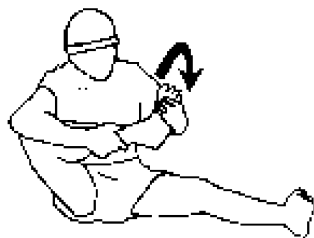


Figure A-16 Ankle Rotations

Running Exercises. Retrieved 26 October 2006, <http://www.physionline.co.za/conditions/article.asp?id=46>

From a sitting position, rotate your foot in a clockwise, and then a counterclockwise, direction.

Switch and repeat on the opposite side.



Figure A-17 Calf Stretch

Smart Start: A Flexible Way to Get Fit. Retrieved 26 October 2006, from <http://www.in-motion.ca/walkingworkout/plan/flexibility/>

Stand three steps away from and facing a wall. Step in towards the wall with your right leg, bending your right knee and keeping your left leg straight. Extending your arms with your palms forward, reach out to the wall and let your body fall toward the wall. Keep your toes forward and your heels down. Lean your body into the wall with your left leg straight behind your body. You should feel the stretch in your left calf.

Hold this position for a minimum of 10 seconds and repeat on the opposite side.



Figure A-18 Quadriceps Stretch

Smart Start: A Flexible Way to Get Fit. Retrieved 26 October 2006, from <http://www.in-motion.ca/walkingworkout/plan/flexibility/>

Stand with your hand against a wall for balance. Lift your left foot off the ground, bending your knee as if you are trying to kick your bottom with your heel. Do not lean forward at the hips. Grab and hold your ankle with your left hand. You should feel the stretch in your left thigh.

Hold this position for a minimum of 10 seconds and repeat on the opposite side.

TEN WEEK RUNNING SCHEDULE

Week	Run	Walk	Number of Cycles	Notes
1	2 min	4 min	5	
2	3 min	3 min	5	
3	5 min	2.5 min	4	
4	7 min	3 min	3	
5	8 min	2 min	3	
6	9 min	2 min	2	Run an additional 8 min after the two cycles are completed.
7	9 min	1 min	3	
8	13 min	2 min	2	
9	14 min	1 min	2	
10	30 min			

Note: Always remember to include a warm-up and a cool-down in your schedule.

Figure B-1 Sample Running Schedule

"First Steps", by Mark Will-Weber, 2006, Runner's World: Beginner's: Training, Copyright 2006 by Rodale Inc. Retrieved 18 April 2007, from <http://www.runnersworld.com/article/printer/1,7124,s6-380-381-386-678-0,00.html>

THIS PAGE INTENTIONALLY LEFT BLANK



COMMON TRAINING INSTRUCTIONAL GUIDE



SECTION 3

EO C211.03 – FIRE THE CADET AIR RIFLE USING A SLING FOLLOWING PHYSICAL ACTIVITY

Total Time:

30 min

PREPARATION

PRE-LESSON INSTRUCTIONS

Resources needed for the delivery of this lesson are listed in the lesson specification located in A-CR-CCP-702/PG-001, Chapter 4. Specific uses for said resources are identified throughout the Instructional Guide within the TP for which they are required.

Review the lesson content and become familiar with the material prior to delivering the lesson.

Construct a range IAW A-CR-CCP-177/PT-001.

PRE-LESSON ASSIGNMENT

N/A.

APPROACH

An interactive lecture was chosen for TP1 to review holding techniques using the cadet air rifle sling.

A practical activity was chosen for TP2 to TP4 as it is an interactive way to allow the cadets to experience firing the cadet air rifle using the cadet air rifle sling following physical activity.

INTRODUCTION

REVIEW

Review EO C111.03 (Fire the Cadet Air Rifle Following Physical Activity).

OBJECTIVES

By the end of this lesson the cadet shall be expected to demonstrate summer biathlon marksmanship skills using the cadet air rifle.

IMPORTANCE

It is important for cadets to be able to adjust the sling on the cadet air rifle and aim while in the prone position because these skills will be useful during summer biathlon activities.

Teaching Point 1**Review Holding Techniques Using the Cadet Air Rifle Sling**

Time: 5 min

Method: Interactive Lecture

The cadet air rifle sling helps the cadet maintain a comfortable and stable position, improving the ability to hold the cadet air rifle. It also allows the right hand to be free to load the air rifle while the rifle remains in position.

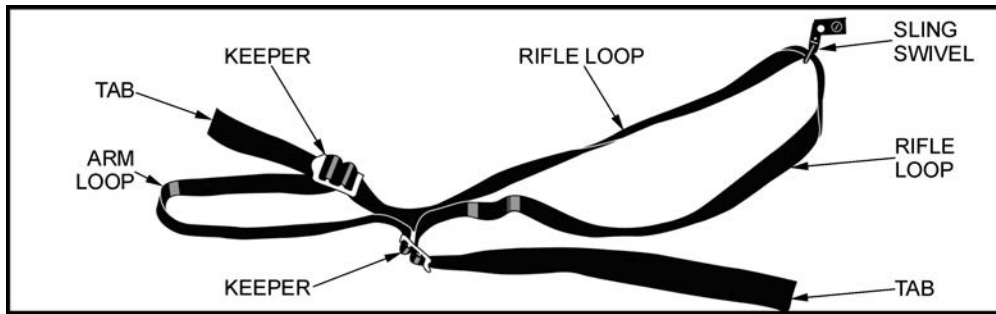
ASSEMBLING THE SLING

Figure 1 Cadet Air Rifle Sling

A-CR-CCP-121/PT-001 (p. 6-17)

The cadet air rifle sling is assembled in the following sequence:

1. Hold the sling parallel to the ground with the short section in the left hand, ensuring the rounded tip of the keeper is pointing to the left.
2. Take the tab of the short section, loop it through the middle slot of the keeper and then back down through the front slot nearest to the rounded tip. The short section will now form a loop.
3. Turn the sling over and slide the sling swivel onto the long section. Ensure the sling swivel hangs downwards, as it will later attach to the rifle.
4. Loop the tab of the long section up through the middle slot of the keeper and then back through the rear slot of the keeper.



An assistant instructor can be used to demonstrate as the instructor explains wearing, adjusting and attaching the cadet air rifle sling.

POSITIONING THE SLING ON THE ARM

The sling arm loop should be positioned on the upper part of the arm, above the bicep muscle near the shoulder. The sling can be held in place by the rubber pad on a shooting jacket. When a shooting jacket is not worn, the sling can be kept in place using a safety pin. This will prevent the sling from slipping down the arm while in the prone position.

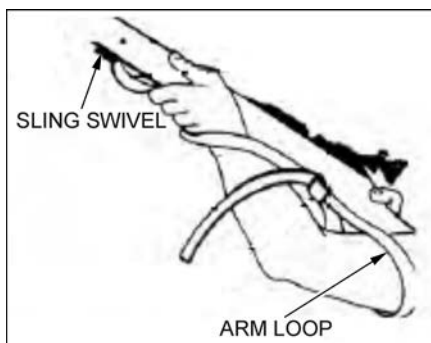


Figure 2 Positioning Sling

Daisy Outdoor Products, Operational Manual – AVANTI Legend EX Model 853C, Daisy Outdoor Products (p. 7)

ADJUSTING THE ARM LOOP

To adjust the arm loop, pull the tab away from the keeper. If the sling is too loose, it will not fully support the cadet air rifle and it will have to be kept in place using the muscles. If the sling is too tight, it will restrict blood flow to the arm and can cause discomfort, numbness, or a more pronounced feel of the body's pulse. Therefore, the sling must be comfortable without pinching the arm, while providing maximum support of the cadet air rifle.

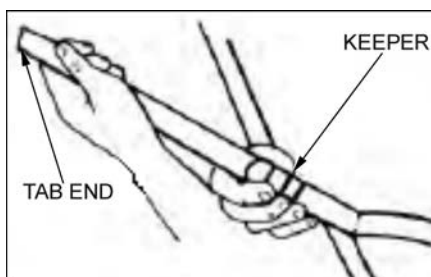


Figure 3 Adjusting Arm Loop

Daisy Outdoor Products, Operational Manual – AVANTI Legend EX Model 853C, Daisy Outdoor Products (p. 8)

ATTACHING THE SLING TO THE CADET AIR RIFLE

To attach the sling to the cadet air rifle:

- open the keeper on the sling swivel by pressing on the screw;
- insert the swivel pin into the hole of the sling swivel on the fore end of the rifle; and
- screw the keeper over the pin to lock the swivel in place.

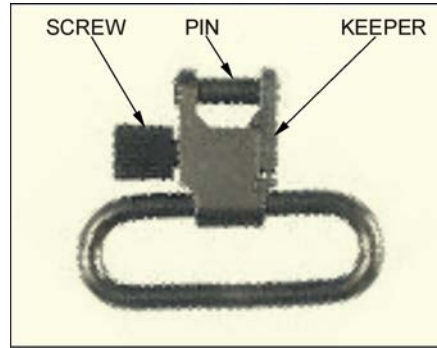


Figure 4 Sling Swivel

D Cmts 3, 2007, Ottawa, ON: Department of National Defence

ADJUSTING THE RIFLE LOOP

To adjust the rifle loop, pull the tab away from the keeper. The tension of the sling should allow the forearm to be in its proper position. If the sling is too loose, it will not provide maximum support of the cadet air rifle. If the sling is too tight, it could cause discomfort and affect the cadet's position.

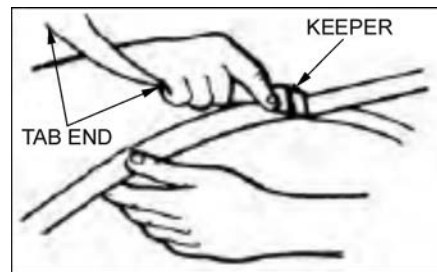


Figure 5 Adjusting Rifle Loop

Daisy Outdoor Products, Operational Manual – AVANTI Legend EX Model 853C, Daisy Outdoor Products (p. 8)

CONFIRMATION OF TEACHING POINT 1

QUESTIONS

- Q1. What is the purpose of the cadet air rifle sling?
- Q2. Where should the cadet air rifle sling be positioned on the arm?
- Q3. Why is it important to not over tighten the sling on your arm?

ANTICIPATED ANSWERS

- A1. The cadet air rifle sling helps the cadet maintain a comfortable and stable position, improving the ability to hold the cadet air rifle.
- A2. The sling arm loop should be positioned on the upper part of the arm, above the bicep muscle near the shoulder.
- A3. If the sling is too tight, it will restrict blood flow to the arm and can cause discomfort, numbness, or a more pronounced feel of the body's pulse.

Teaching Point 2**Conduct a Warm-up Session Composed of Light Cardiovascular Exercises**

Time: 5 min

Method: Practical Activity



The following information will be explained to the cadets during the warm-up activity.

PURPOSE OF A WARM-UP

A warm-up is composed of stretches and light cardiovascular exercises designed to:

- stretch the muscles;
- gradually increase respiratory action and heart rate;
- expand the muscles' capillaries to accommodate the increase in blood circulation which occurs during physical activity; and
- raise the muscle temperature to facilitate reactions in muscle tissue.

GUIDELINES FOR STRETCHING

The following guidelines should be followed while stretching to prepare for physical activity and to help prevent injury:

- Stretch all major muscle groups, including the back, chest, legs, and shoulders.
- Never bounce while stretching.
- Hold each stretch for 10 to 30 seconds to let the muscles release fully.
- Repeat each stretch two to three times.
- When holding a stretch, support the limb at the joint.
- Static stretching, which is stretching a muscle and holding it in position without discomfort for 10 to 30 seconds, is considered the safest method.
- Stretching helps to relax the muscles and improve flexibility, which is the range of motion in the joints.
- As a guide, allow 10 minutes to warm-up for every hour of physical activity.



The stretches chosen should focus on the areas of the body that will be used the most during the activity.

ACTIVITY

OBJECTIVE

The objective of this warm-up activity is to stretch the muscles and perform light cardiovascular exercises to prepare the body for physical activity and to help prevent injuries.

RESOURCES

N/A.

ACTIVITY LAYOUT

N/A.

ACTIVITY INSTRUCTIONS

- Arrange the cadets in either a warm-up circle or in rows (as illustrated in Figures 6 and 7).

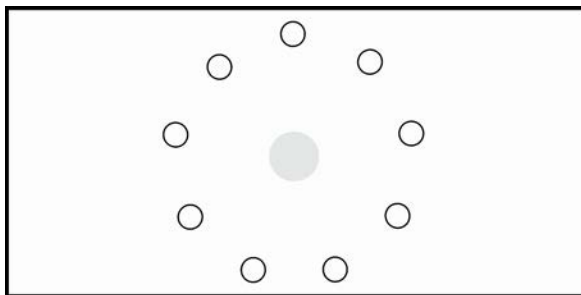


Figure 6 Instructor in the Centre of a Warm-up Circle
D Cdts 3, 2006, Ottawa, ON: Department of National Defence

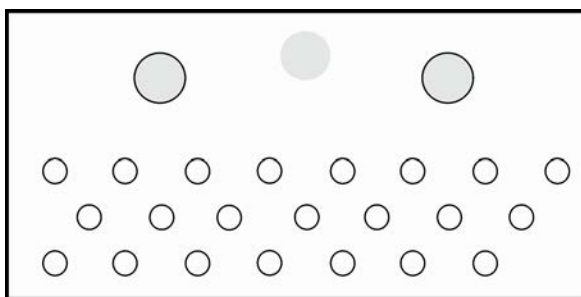


Figure 7 Instructor at the Front With Two Assistant Instructors
D Cdts 3, 2006, Ottawa, ON: Department of National Defence

- Demonstrate before having the cadets attempt each stretch/light cardiovascular exercise.
- Assistant instructors can help demonstrate the exercises and ensure the cadets are performing them correctly.
- Have cadets perform each stretch/light cardiovascular exercise.



Light cardiovascular activities should be done to warm-up the muscles prior to stretching to avoid injury to or tearing of the muscles. For example, running on the spot for 30 seconds or performing jumping jacks should be performed prior to conducting the stretching activities located at Annex A.

SAFETY

- Ensure there are at least two arm lengths between the cadets so they can move freely.
- Ensure the cadets perform the stretches and light cardiovascular exercises in a safe manner, following the guidelines for stretching listed in this TP.

CONFIRMATION OF TEACHING POINT 2

The cadets' participation in the warm-up will serve as the confirmation of this TP.

Teaching Point 3

Conduct an Activity Where Cadets Will Fire the Cadet Air Rifle Using a Sling Following Physical Activity

Time: 10 min

Method: Practical Activity

ACTIVITY

OBJECTIVE

The objective of this activity is to fire the cadet air rifle using the cadet air rifle sling following physical activity.

RESOURCES

- Cadet air rifle (one per firing lane).
- Cadet air rifle sling (one per firing lane).
- Shooting mats (two per firing lane).
- BART and target frame (one per firing lane).
- Safety glasses/goggles.



If resources are available, the number of firing lanes may be increased.

ACTIVITY LAYOUT

Construct a range IAW A-CR-CCP-177/PT-001.

ACTIVITY INSTRUCTIONS

1. The cadets' heart rate should be elevated from participating in the warm-up activity in TP2.
2. Have the cadets approach the firing point and prepare to fire using the techniques outlined in EO C111.04 (Fire the Cadet Air Rifle Following Physical Activity).
3. Have the cadets adopt the prone position, attach the cadet air rifle sling, and simulate firing at the BART.
4. Repeat steps one to three for each relay until all cadets have participated.

SAFETY

Range activities will be conducted IAW A-CR-CCP-177/PT-001.

CONFIRMATION OF TEACHING POINT 3

The cadets' participation in the activity will serve as the confirmation of this TP.

Teaching Point 4

Conduct a Cool-down Session Composed of Light Cardiovascular Exercises

Time: 5 min

Method: Practical Activity



The following information will be explained to the cadets during the cool-down activity.

PURPOSE OF A COOL-DOWN

A cool-down is composed of stretches and light cardiovascular exercises designed to:

- allow the body time to slowly recover from physical activity and to help prevent injury;
- prepare the respiratory system to return to its normal state; and
- stretch the muscles to help relax and restore them to their resting length.



The stretches chosen should focus on the areas of the body that were used the most during the activity.

ACTIVITY

OBJECTIVE

The objective of the cool-down is to stretch the muscles and perform light cardiovascular exercises that allow the body time to recover from physical activity, and to prevent injury.

RESOURCES

N/A.

ACTIVITY LAYOUT

N/A.

ACTIVITY INSTRUCTIONS

- Arrange the cadets in either a warm-up circle or in rows (as illustrated in Figures 6 and 7).
- Demonstrate before having the cadets attempt each stretch/light cardiovascular exercise.
- Assistant instructors can help demonstrate the movements and ensure the cadets are performing them correctly.
- Have cadets perform each stretch/light cardiovascular exercise.

SAFETY

- Ensure there are at least two arm lengths between the cadets so they can move freely.
- Ensure the cadets perform the stretches and light cardiovascular exercises in a safe manner, following the guidelines for stretching listed in TP2.

CONFIRMATION OF TEACHING POINT 4

The cadets' participation in the cool-down will serve as the confirmation of this TP.

END OF LESSON CONFIRMATION

The cadets' participation in the activity in TP3 will serve as the confirmation of this lesson.

CONCLUSION

HOMEWORK/READING/PRACTICE

N/A.

METHOD OF EVALUATION

N/A.

CLOSING STATEMENT

Being able to fire the cadet air rifle using the cadet air rifle sling following physical activity will be useful when participating in summer biathlon activities.

INSTRUCTOR NOTES/REMARKS

N/A.

REFERENCES

A0-027 A-CR-CCP-177/PT-001 D Cdts 3. (2001). *Canadian Cadet Movement: Cadet Marksmanship Program Reference Manual*. Ottawa, ON: Department of National Defence.

C0-002 (ISBN 0-88962-630-8) LeBlanc, J. & Dickson, L. (1997). *Straight Talk About Children and Sport: Advice for Parents, Coaches, and Teachers*. Oakville, ON and Buffalo, NY: Mosaic Press.

C0-057 Martha Jefferson Hospital. (2001). *Warm-ups*. Retrieved 26 October 2006, from <http://www.marthajefferson.org/warmup.php>.

C0-058 Webb Physiotherapists Inc. (ND). *Running Exercises*. Retrieved 26 October 2006, from <http://www.physionline.co.za/conditions/article.asp?id=46>.

C0-059 Webb Physiotherapists Inc. (ND). Exercise Programme for Squash, Tennis, Softball, Handball. Retrieved 25 October 2006, from <http://www.physionline.co.za/conditions/article.asp?id=49>.

C0-060 Impacto Protective Products Inc. (1998). *Exercises*. Retrieved 25 October 2006, from <http://www.2protect.com/work3b.htm>.

C0-061 City of Saskatoon, Community Services Department. (2006). *Stretch Your Limits: A Smart Guide To Stretching for Fitness*. Retrieved 26 October 2006, from <http://www.in-motion.ca/walkingworkout/plan/flexibility/>.

C0-080 Cool Running. (2007). *Cool Running*. Retrieved 12 February 2007, from http://www.coolrunning.com/engine/2/2_3/181.shtml.

C0-085 Daisy Outdoor Products. (2006). *AVANTI Competition Pellet Rifle: Operation Manual: AVANTI Legend Model 853C*. Rogers, AR: Daisy Outdoor Products.

C0-089 (ISBN 0-936070-22-6) Anderson, B. (2000). *Stretching: 20th Anniversary* (Rev. ed.). Bolinas, CA: Shelter Publications, Inc.

C0-154 Hansen, B. (1999). *Moving on the Spot: Fun and Physical Activity: A Collection of 5-Minute Stretch and Movement Sessions*. Retrieved 26 October 2006, from <http://lin.ca/resource/html/dn3.htm#11>.

SAMPLE STRETCHES

NECK

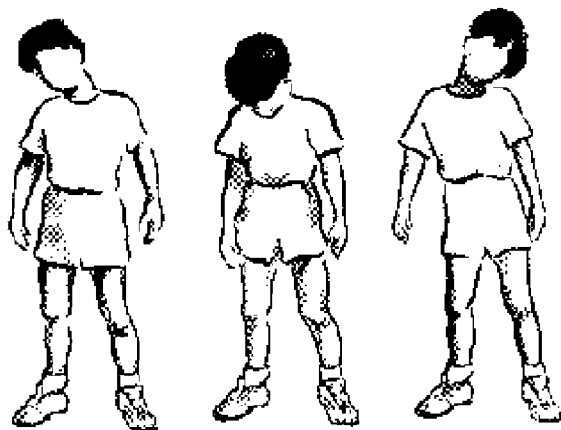


Figure A-1 Neck Stretch

Moving on the Spot: A Collection of 5-Minute Stretch and Movement Sessions, by B. Hanson, 1999, Toronto, Ontario: Toronto Public Health. Retrieved 26 October 2006, from <http://www.lin.ca/resource/html/dn3.htm#1>

Slowly roll your head across your chest from shoulder to shoulder. Do not roll your head backwards.

SHOULDERS



Figure A-2 Shoulder Push

Moving on the Spot: A Collection of 5-Minute Stretch and Movement Sessions, by B. Hanson, 1999, Toronto, Ontario: Toronto Public Health. Retrieved 26 October 2006, from <http://www.lin.ca/resource/html/dn3.htm#1>

Stand and extend your arms behind you, interlocking your fingers. Push up and back with your shoulders.

Hold this position for a minimum of 10 seconds.

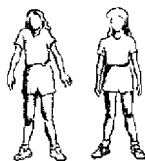


Figure A-3 Shoulder Shrug

Moving on the Spot: A Collection of 5-Minute Stretch and Movement Sessions, by B. Hanson, 1999, Toronto, Ontario: Toronto Public Health. Retrieved 26 October 2006, from <http://www.lin.ca/resource/html/dn3.htm#1>

Stand and raise your shoulders as high as possible and then lower your shoulders, stretching your neck up.

Pull your shoulders back as far as possible and then round your shoulders forward by pushing your shoulders forward as far as possible.

Hold each position for a minimum of 10 seconds.



Figure A-4 Arm Circles

Warm Ups, by Martha Jefferson Hospital, Copyright 2001 by Martha Jefferson Hospital. Retrieved 26 October 2006, from <http://www.marthajefferson.org/warmup.php>

Hold your arms straight out, palms up. Make small circles with your arms, gradually increasing the size.
Reverse the direction of your circles.



Figure A-5 Shoulder Stretch

Smart Start: A Flexible Way to Get Fit. Retrieved 26 October 2006, from <http://www.in-motion.ca/walkingworkout/plan/flexibility/>

Either standing or sitting, take your right arm in your left hand and bring it across your chest, supporting the joint by holding it behind the elbow. Pull the elbow lightly towards your chest. You should feel the stretch in your right shoulder.

Hold this position for a minimum of 10 seconds and repeat on the opposite side.

ARMS



Figure A-6 Wrist Rotations

Exercises. Copyright 1998 by Impacto Protective Products Inc. Retrieved 26 October 2006, from <http://www.2protect.com/home.htm>

Rotate your hands in circular motions at the wrist.
Change direction and repeat on both sides.



Figure A-7 Triceps Stretch

Smart Start: A Flexible Way to Get Fit. Retrieved 26 October 2006, from <http://www.in-motion.ca/walkingworkout/plan/flexibility/>

Stand and bring your right arm over your head, bent at the elbow. Use your left hand to gently pull your arm down.

Hold this position for a minimum of 10 seconds and repeat on the opposite side.



Figure A-8 Forearm Stretch

Exercise Programme for Squash, Tennis, Softball, Handball. Retrieved 26 October 2006, from <http://www.physionline.co.za/conditions/article.asp?id=49>

In a kneeling position, place your hands on the floor in front of you with your fingers pointing toward your knees, and your thumbs pointing out. Keeping your hands flat on the floor, lean back. Hold this position for a minimum of 10 seconds.

CHEST AND ABDOMINALS



Figure A-9 Chest Stretch

Smart Start: A Flexible Way to Get Fit. Retrieved 26 October 2006, from <http://www.in-motion.ca/walkingworkout/plan/flexibility/>

Stand facing a wall. With your right arm bent and your elbow at shoulder height, place your palm against the wall. Turn your body away from your right arm. You should feel the stretch on the front side of your armpit and across the front of your chest.

Hold this position for a minimum of 10 seconds and repeat on the opposite side.



Figure A-10 Side Stretch

Moving on the Spot: A Collection of 5-Minute Stretch and Movement Sessions, by B. Hanson, 1999, Toronto, Ontario: Toronto Public Health. Retrieved 26 October 2006, from <http://www.lin.ca/resource/html/dn3.htm#1>

Stand with your left arm up over your head. Bend at the waist towards the right side of your body.

Hold this position for a minimum of 10 seconds and repeat on the opposite side.

BACK



Figure A-11 Lower Back Stretch

Smart Start: A Flexible Way to Get Fit. Retrieved 26 October 2006, from <http://www.in-motion.ca/walkingworkout/plan/flexibility/>

Lie on your back and bring your knees toward your chest. Grasp the back of your knees. Hold this position for a minimum of 10 seconds.

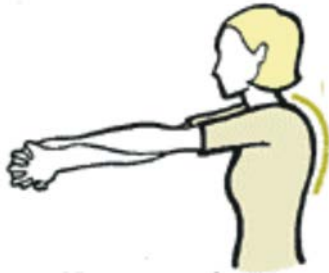


Figure A-12 Upper Back Stretch

Smart Start: A Flexible Way to Get Fit. Retrieved 26 October 2006, from <http://www.in-motion.ca/walkingworkout/plan/flexibility/>

Extend your arms straight in front of you at shoulder height crossing one arm over the other. With the palms facing each other, intertwine your fingers and press out through your arms. Let your chin fall to your chest as you exhale. You should feel the stretch in the upper back.

Hold this position for a minimum of 10 seconds and repeat on the opposite side.

LEGS



Figure A-13 Hamstring Stretch

Smart Start: A Flexible Way to Get Fit. Retrieved 26 October 2006, from <http://www.in-motion.ca/walkingworkout/plan/flexibility/>

Lie flat on the floor with your knees bent and your back flat on the floor. Slowly raise and straighten one leg, grasping it behind your thigh with both hands. Hold this position for a minimum of 10 seconds.



Figure A-14 Inner Thigh Stretch

Smart Start: A Flexible Way to Get Fit. Retrieved 26 October 2006, from <http://www.in-motion.ca/walkingworkout/plan/flexibility/>

Sit on the floor with your knees bent and the soles of your feet together. Grab your toes and pull yourself forward while keeping your back and neck straight.

Hold this position for a minimum of 10 seconds.

Grab your ankles and push your knees down toward the floor with your elbows.

Hold this position for a minimum of 10 seconds.



Figure A-15 Hip Flexor

Smart Start: A Flexible Way to Get Fit. Retrieved 26 October 2006, from <http://www.in-motion.ca/walkingworkout/plan/flexibility/>

Kneel on your right knee. Position your left foot in front of you, bending your knee and placing your left hand on that leg for stability. Keep your back straight and abdominal muscles tight. Lean forward, shifting more body weight onto your front leg. You should feel the stretch in the front of your hip and the thigh of the leg you are kneeling on. Cushion your kneecap with a folded towel if necessary.

Hold this position for a minimum of 10 seconds and repeat on the opposite side.

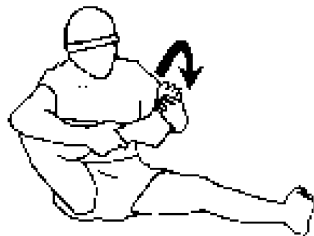


Figure A-16 Ankle Rotations

Running Exercises. Retrieved 26 October 2006, <http://www.physionline.co.za/conditions/article.asp?id=46>

From a sitting position, rotate your foot in a clockwise, and then a counterclockwise, direction.

Switch and repeat on the opposite side.



Figure A-17 Calf Stretch

Smart Start: A Flexible Way to Get Fit. Retrieved 26 October 2006, from <http://www.in-motion.ca/walkingworkout/plan/flexibility/>

Stand three steps away from and facing a wall. Step in towards the wall with your right leg, bending your right knee and keeping your left leg straight. Extending your arms with your palms forward, reach out to the wall and let your body fall toward the wall. Keep your toes forward and your heels down. Lean your body into the wall with your left leg straight behind your body. You should feel the stretch in your left calf.

Hold this position for a minimum of 10 seconds and repeat on the opposite side.



Figure A-18 Quadriceps Stretch

Smart Start: A Flexible Way to Get Fit. Retrieved 26 October 2006, from <http://www.in-motion.ca/walkingworkout/plan/flexibility/>

Stand with your hand against a wall for balance. Lift your left foot off the ground, bending your knee as if you are trying to kick your bottom with your heel. Do not lean forward at the hips. Grab and hold your ankle with your left hand. You should feel the stretch in your left thigh.

Hold this position for a minimum of 10 seconds and repeat on the opposite side.



COMMON TRAINING INSTRUCTIONAL GUIDE



SECTION 4

EO C211.04 – PARTICIPATE IN A COMPETITIVE SUMMER BIATHLON ACTIVITY

Total Time: 180 min

PREPARATION

PRE-LESSON INSTRUCTIONS

Resources needed for the delivery of this lesson are listed in the lesson specification located in A-CR-CCP-702/PG-001, Chapter 4. Specific uses for said resources are identified throughout the Instructional Guide within the TP for which they are required.

Review the lesson content and become familiar with the material prior to delivering the lesson.

Ensure that all members involved in conducting this activity are well versed in the competition guidelines located at Annex A.

Ensure a first aid station is set up.

Set up a running route of 500 to 1000 m on alternating terrain and a range IAW A-CR-CCP-177/PT-001.

Photocopy Annex B.

PRE-LESSON ASSIGNMENT

N/A.

APPROACH

An interactive lecture was chosen for TP1 to illustrate the application of rules, principles, and concepts of summer biathlon.

A practical activity was chosen for TP2 to TP4 as it is an interactive way to introduce cadets to summer biathlon. This activity contributes to the development of these skills and knowledge in a fun and challenging setting.

INTRODUCTION

REVIEW

N/A.

OBJECTIVES

By the end of this lesson the cadet shall have participated in a competitive summer biathlon activity.

IMPORTANCE

It is important for cadets to participate in a competitive summer biathlon activity because it requires personal discipline, develops marksmanship skills, and promotes physical fitness.

Teaching Point 1

Explain the Components of the Competitive Summer Biathlon Activity

Time: 15 min

Method: Interactive Lecture



Based on the facilities, the cadet should be made aware of the start area, the course, the firing range, and the finish area.

COURSE LAYOUT

Each cadet will:

- run a loop of 500 to 1000 m;
- fire five to eight rounds in an effort to activate all five targets on the biathlon air rifle target (BART);
- run a second loop of 500 to 1000 m;
- fire five to eight rounds in an effort to activate all five targets on the BART;
- run a third loop of 500 to 1000 m; and
- finish the race.



The 500 to 1000 m course should be clearly marked prior to the start of this activity.

RULES AND REGULATIONS

Rules and regulations for the competitive summer biathlon activity include the following:

- Cadets must use the same firing lane for the duration of the activity.
- The run must be completed in the proper sequence and on the marked route.
- Rifles must be placed at the firing point by the range staff and will remain there for the duration of the activity.
- All firing will be done in the prone position.
- The cadet air rifle sling is the only firing aid that may be used.
- The rifle must be made safe upon completion of firing.
- An inoperable rifle will be replaced by the range staff, the target will be reset, and the cadet will fire five to eight shots with the new rifle.

- Safety infractions will result in time penalties.
- Missed targets will result in time penalties.

SCORING

Scoring will be calculated as follows:

- **Time.** The cadet's final time is the time from the start to the finish, plus any issued penalties.
- **Firing.** For each bout of firing, the number of missed targets will be recorded on the range recording sheet by the lane scorekeeper (located at Annex B). For each missed target, a one-minute penalty will be added to the cadet's total time.

PENALTIES

Penalties will be added to the individual's time, to include:

- Each violation of the principles of fair play or good sportsmanship will result in a one-minute penalty, to include:
 - not giving way in an area of congestion;
 - pushing or shoving;
 - using profanity; and
 - interfering with other competitors.
- Each missed target will result in a one-minute penalty.
- Each safety infraction on the firing point will result in a one-minute penalty to include:
 - not keeping control of the cadet air rifle;
 - moving forward of the firing point; and
 - intentionally firing rounds at objects other than the BART.

OUT OF BOUNDS AREAS

Make cadets aware of all out of bounds areas and safety considerations depending on the training area.

CONFIRMATION OF TEACHING POINT 1

QUESTIONS

- Q1. What are two rules/regulations for this biathlon activity?
- Q2. How will the competitive summer biathlon activity be scored?
- Q3. What is one violation of the principles of fair play/good sportsmanship?

ANTICIPATED ANSWERS

- A1. Rules and regulations for the competitive summer biathlon activity include the following:
- Cadets must use the same firing lane for the duration of the activity.
 - The run must be completed in the proper sequence and on the marked route.

- Rifles must be placed at the firing point by the range staff and will remain there for the duration of the activity.
- All firing will be done in the prone position.
- The cadet air rifle sling is the only firing aid that may be used.
- The rifle must be made safe upon completion of firing.
- An inoperable rifle will be replaced by the range staff, the target will be reset, and the cadet will fire five to eight shots with the new rifle.
- Safety infractions will result in time penalties.
- Missed targets will result in time penalties.

A2. The activity will be scored based on time and penalties.

A3. A violation of the principles of fair play/good sportsmanship may include:

- not giving way in an area of congestion;
- pushing or shoving;
- using profanity; and
- interfering with other competitors.

Teaching Point 2

Conduct a Warm-up Session Composed of Light Cardiovascular Exercises

Time: 10 min

Method: Practical Activity



The following information will be explained to the cadets during the warm-up activity.

PURPOSE OF A WARM-UP

A warm-up is composed of stretches and light cardiovascular exercises designed to:

- stretch the muscles;
- gradually increase respiratory action and heart rate;
- expand the muscles' capillaries to accommodate the increase in blood circulation which occurs during physical activity; and
- raise the muscle temperature to facilitate reactions in muscle tissue.

GUIDELINES FOR STRETCHING

The following guidelines should be followed while stretching to prepare for physical activity and to help prevent injury:

- Stretch all major muscle groups, including the back, chest, legs, and shoulders.
- Never bounce while stretching.
- Hold each stretch for 10 to 30 seconds to let the muscles release fully.
- Repeat each stretch two to three times.
- When holding a stretch, support the limb at the joint.
- Static stretching, which is stretching a muscle and holding it in position without discomfort for 10 to 30 seconds, is considered the safest method.
- Stretching helps to relax the muscles and improve flexibility, which is the range of motion in the joints.
- As a guide, allow 10 minutes to warm-up for every hour of physical activity.



The stretches chosen should focus on the areas of the body that will be used the most during the activity.

ACTIVITY

OBJECTIVE

The objective of this warm-up activity is to stretch the muscles and perform light cardiovascular exercises to prepare the body for physical activity and to help prevent injuries.

RESOURCES

N/A.

ACTIVITY LAYOUT

N/A.

ACTIVITY INSTRUCTIONS

- Arrange the cadets in either a warm-up circle or in rows (as illustrated in Figures 1 and 2).

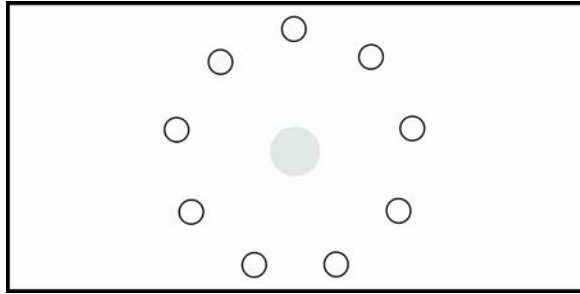


Figure 1 Instructor in the Centre of a Warm-up Circle
D Cdts 3, 2006, Ottawa, ON: Department of National Defence

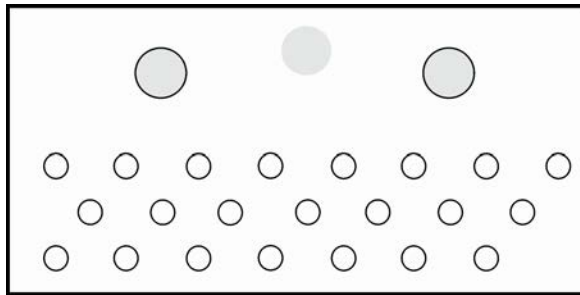



Figure 2 Instructor at the Front With Two Assistant Instructors
D Cdts 3, 2006, Ottawa, ON: Department of National Defence

- Demonstrate before having the cadets attempt each stretch/light cardiovascular exercise.
- Assistant instructors can help demonstrate the exercises and ensure the cadets are performing them correctly.
- Have cadets perform each stretch/light cardiovascular exercise.



Light cardiovascular activities should be done to warm-up the muscles prior to stretching to avoid injury to or tearing of the muscles. For example, running on the spot for 30 seconds or performing jumping jacks should be performed prior to conducting the stretching activities located at Annex C.

SAFETY

- Ensure there are at least two arm lengths between the cadets so they can move freely.
- Ensure the cadets perform the stretches and light cardiovascular exercises in a safe manner, following the guidelines for stretching listed in this TP.

CONFIRMATION OF TEACHING POINT 2

The cadets' participation in the warm-up activity will serve as the confirmation of this TP.

Teaching Point 3**Conduct a Competitive Summer Biathlon Activity**

Time: 135 min

Method: Practical Activity

ACTIVITY**OBJECTIVE**

The objective of this activity is for cadets to participate in a competitive summer biathlon activity.

RESOURCES

Based on 20 cadets per group, the following resources are required per event:

- Cadet air rifles (5);
- Cadet air rifle slings (5);
- Shooting mats (10);
- .177 air rifle pellets (a minimum of 700 pellets);
- Stopwatches (5);
- BART and target frame (5);
- Safety glasses/goggles (8);
- Pens/pencils;
- Notice board;
- Biathlon scoresheets located at Annex B;
- Course control sheets located at Annex B; and
- Range recording sheets located at Annex B.

ACTIVITY LAYOUT

- Set up a running route of approximately 500 to 1000 m on alternating terrain.
- Set up an air rifle range in accordance with Annex A.
- Set up targets and target frames.
- Place two shooting mats per shooting lane.
- Place a cadet air rifle at each firing point.
- Place a pair of safety glasses/goggles at each firing point.

ACTIVITY INSTRUCTIONS

Activity instructions are located at Annex A.

SAFETY

- Ensure all range safety procedures are followed.
- Ensure cadets drink plenty of water and apply sunscreen.
- Ensure the running route is clearly marked and crossing points are monitored anywhere a road may be crossed.
- Ensure a first aider is identified at the start of the activity and is available at all times.
- Ensure water is available for the cadets during and after the activity.

CONFIRMATION OF TEACHING POINT 3

The cadets' participation in the activity will serve as the confirmation of this TP.

Teaching Point 4

Conduct a Cool-down Session Composed of Light Cardiovascular Exercises

Time: 10 min

Method: Practical Activity



The following information will be explained to the cadets during the cool-down activity.

PURPOSE OF A COOL-DOWN

A cool-down is composed of stretches and light cardiovascular exercises designed to:

- allow the body time to slowly recover from physical activity and to help prevent injury;
- prepare the respiratory system to return to its normal state; and
- stretch the muscles to help relax and restore them to their resting length.



The stretches chosen should focus on the areas of the body that were used the most during the activity.

ACTIVITY

OBJECTIVE

The objective of the cool-down is to stretch the muscles and perform light cardiovascular exercises that allow the body time to recover from physical activity, and to prevent injury.

RESOURCES

Area large enough for all cadets to conduct a cool-down activity.

ACTIVITY LAYOUT

N/A.

ACTIVITY INSTRUCTIONS

- Arrange the cadets in either a cool-down circle or in rows (as illustrated in Figures 1 and 2).
- Demonstrate before having the cadets attempt each stretch/light cardiovascular exercise.
- Assistant instructors can help demonstrate the movements and ensure the cadets are performing them correctly.
- Have cadets perform each stretch/light cardiovascular exercise.



Sample stretches are located at Annex C.

SAFETY

- Ensure there are at least two arm lengths between the cadets so they can move freely.
- Ensure the cadets perform the stretches and light cardiovascular exercises in a safe manner, following the guidelines for stretching listed in TP2.

CONFIRMATION OF TEACHING POINT 4

The cadets' participation in the cool-down activity will serve as the confirmation of this TP.

END OF LESSON CONFIRMATION

The cadets' participation in the competitive summer biathlon activity will serve as the confirmation of this lesson.

CONCLUSION**HOMEWORK/READING/PRACTICE**

N/A.

METHOD OF EVALUATION

N/A.

CLOSING STATEMENT

Competitive summer biathlon is an activity that requires personal discipline, develops marksmanship skills, and promotes physical fitness. Competitive biathlon opportunities are available at the local, regional, and national level.

INSTRUCTOR NOTES/REMARKS

Results should be posted for cadets to review. PO 211 is a complementary training activity. It is designed to provide an opportunity for the cadets to participate in a competitive summer biathlon activity.

EOs C111.01 (Participate in a Biathlon Briefing), C111.02 (Run Short Wind Sprints), C111.03 (Introduction to Summer Biathlon Marksmanship Skills Using the Cadet Air Rifle), C211.01 (Identify Civilian Biathlon Opportunities), C211.02 (Run on Alternating Terrain), and C211.03 (Fire the Cadet Air Rifle Using a Sling Following Physical Activity) shall be taught prior to conducting this lesson.

REFERENCES

A0-027 A-CR-CCP-177/PT-001 D Cdts 3. (2001). *Canadian Cadet Movement: Cadet Marksmanship Program Reference Manual*. Ottawa, ON: Department of National Defence.

A0-032 Cadets Canada. (2002). *Biathlon Competition Rules and IBU/Cadet Disciplinary Rules*. Ottawa, ON: Department of National Defence.

A0-036 Cadets Canada. (ND). *Canadian Cadet Movement: Biathlon Championship Series*. Ottawa, ON: Department of National Defence.

C0-002 (ISBN 0-88962-630-8) LeBlanc, J. & Dickson, L. (1997). *Straight Talk About Children and Sport: Advice for Parents, Coaches, and Teachers*. Oakville, ON and Buffalo, NY: Mosaic Press.

C0-057 Martha Jefferson Hospital. (2001). *Warm-ups*. Retrieved 26 October 2006, from <http://www.marthajefferson.org/warmup.php>.

C0-058 Webb Physiotherapists Inc. (ND). *Running Exercises*. Retrieved 26 October 2006, from <http://www.physionline.co.za/conditions/article.asp?id=46>.

C0-059 Webb Physiotherapists Inc. (ND). *Exercise Programme for Squash, Tennis, Softball, Handball*. Retrieved 25 October 2006, from <http://www.physionline.co.za/conditions/article.asp?id=49>.

C0-060 Impacto Protective Products Inc. (1998). *Exercises*. Retrieved 25 October 2006, from <http://www.2protect.com/work3b.htm>.

C0-061 City of Saskatoon, Community Services Department. (2006). *Stretch Your Limits: A Smart Guide To Stretching for Fitness*. Retrieved 26 October 2006, from <http://www.in-motion.ca/walkingworkout/plan/flexibility/>.

C0-089 (ISBN 0-936070-22-6) Anderson, B. (2000). *Stretching: 20th Anniversary* (Rev. ed.). Bolinas, CA: Shelter Publications, Inc.

C0-154 Hansen, B. (1999). *Moving on the Spot: Fun and Physical Activity: A Collection of 5-Minute Stretch and Movement Sessions*. Retrieved 26 October 2006, from <http://lin.ca/resource/html/dn3.htm#11>.

GUIDELINES FOR CONDUCTING A COMPETITIVE SUMMER BIATHLON ACTIVITY

OBJECTIVES

The objectives of the competitive summer biathlon activity are:

- to practice and improve marksmanship skills;
- to improve the level of physical fitness; and
- to introduce the sport of summer biathlon.

COMPOSITION

Each cadet will enter as an individual.

FACILITIES

The facilities required to conduct a competitive summer biathlon activity are:

- a route, on alternating terrain, of approximately 500 to 1000 m with the start and finish lines located close to the range. The route should be wide enough to accommodate a maximum of 10 cadets running at one time. When roads are to be crossed, they must be clearly marked and a central crossing point established with traffic control provided; and
- an air rifle range constructed IAW A-CR-CCP-177/PT-001 Chapter 1, Section 1, with a minimum of one firing lane per cadet per group.

PARTICIPANTS

This activity may be conducted with cadets from multiple corps. A sample invitation for the competitive summer biathlon activity is located at Annex D.

STAFFING

Numerous staff are required to conduct a competitive summer biathlon activity. These appointments may be filled by corps staff, and shall include:

- **Technical Delegate.** Responsible for the overall conduct of the competition, including issuing penalties, and interpreting the rules.
- **Range Safety Officer (RSO).** Responsible for the overall conduct of the activities on the range.
- **Assistant RSO.** Responsible for targets, issuing ammunition, and assisting the RSO, as required.
- **Lane Scorekeeper.** Responsible for scoring targets and recording results on the range recording sheet (located at Annex B).
- **Chief of Statistics.** Responsible for compiling all the event data (e.g. range results, start/finish time, and any penalties issued).
- **Runner.** Responsible for collecting the scoring sheets and delivering them to the chief of statistics.
- **Start and Finish Line Chief.** Responsible for starting the run and recording the finish times on the scoresheet (located at Annex B).

- **Course Control.** Responsible for recording each time the cadet runs a loop on the course control sheet (located at Annex B).
- **First Aider.** Responsible for dealing with any injuries that may occur during the competition.

FORMAT

Team Captain's Meeting

All cadets will attend the team captain's meeting. This meeting includes all the essential information required by the cadets to participate in the competitive summer biathlon activity. The cadets are given:

- start times;
- range lane assignments;
- weather updates; and
- introductions to the competition staff.

The Running Loop

Each cadet will run three separate loops of 500 to 1000 m. Each running loop will consist of:

- assembling for an individual start (cadets will begin at 10-second intervals for the first loop); and
- crossing the finish line.

The Range

Each cadet will fire five to eight pellets in an effort to activate all five targets on the BART. After each bout of firing, the appropriate lane scorer will record the cadet's results and reset the BART.

SEQUENCE

This competitive summer biathlon activity will be conducted in the following sequence:

1. running a loop of 500 to 1000 m;
2. firing five to eight pellets at the BART;
3. running a loop of 500 to 1000 m;
4. firing five to eight pellets at the BART;
5. running a third loop of 500 to 1000 m; and
6. crossing the finish line.

EQUIPMENT

Based on 20 cadets per group, the equipment required to conduct the competitive summer biathlon activity shall include, but is not limited to the following:

- Cadet air rifles (5);
- Cadet air rifle slings (5);
- Shooting mats (10);
- .177 air rifle pellets (a minimum of 700 pellets);

- Stop watches (5);
- BART and target frame (5);
- Safety glasses (8);
- Pens/pencils;
- Notice board;
- Biathlon scoresheets located at Annex B;
- Course control sheets located at Annex B; and
- Range recording sheets located at Annex B.

DRESS

Appropriate clothing according to the weather forecast.

RULES AND REGULATIONS

- Cadets must use the same firing lane for the duration of the activity.
- The run must be completed in the proper sequence and on the marked route.
- Rifles must be placed on the firing point by the range staff and will remain there for the duration of the activity.
- All firing will be done in the prone position.
- The cadet air rifle sling is the only firing aid that may be used.
- The rifle must be made safe upon completion of firing.
- An inoperable rifle will be replaced by the range staff, the target will be reset, and the cadet will fire five to eight shots with the new rifle.
- Safety infractions will result in time penalties.
- Missed targets will result in time penalties.

SCORING

Scoring will be calculated as follows:

- **Time.** The cadet's final time is the time from the start to the finish, plus any issued penalties.
- **Firing.** For each bout of firing, the number of missed targets will be recorded on the range recording sheet by the lane scorekeeper (located at Annex B). For each missed target, a one-minute penalty will be added to the cadet's total time.

PENALTIES

Penalties will be added to the individual's time, to include:

- Each violation of the principles of fair play or good sportsmanship will result in a one-minute penalty, to include:
 - not giving way in an area of congestion;
 - pushing or shoving;
 - using profanity; and
 - interfering with other competitors.
- Each missed target will result in a one-minute penalty.
- A one-minute penalty will be issued for each safety infraction, to include:
 - not keeping control of the cadet air rifle;
 - moving forward of the firing point; and
 - intentionally firing rounds at objects other than the BART.

OUT OF BOUNDS AREAS

Out of bounds areas are to be clearly identified prior to the start of the competitive summer biathlon activity.

AWARDS

Awards instructions are located at Annex E.

NOTES

- Course control staff will record each time a cadet runs through a loop. See course control sheet located at Annex B.
- The start and finish line chief will keep records for each cadet. When the sheet is full or nearly full the runner will take the sheet to the chief of statistics. See scoresheet located at Annex B.
- Bibs may be used to identify cadets, if available.

COMPETITION GUIDELINES

COURSE CONTROL SHEET

Cadet Name	Loop 1 Verification	Loop 2 Verification	Loop 3 Verification

Figure B-1 Course Control Sheet
D Cdts 3, 2006, Ottawa, ON: Department of National Defence

SCORESHEET

Cadet Name	Start Time	Loop One	Loop Two	Loop Three	End Time	Run/Safety Penalties	Firing Penalties	Total Time

Note: The start and finish line chief is responsible for recording the run times and presenting the scoresheet(s) to the scorekeeper.

Figure B-2 Scoresheet

D Cnts 3, 2006, Ottawa, ON: Department of National Defence

RANGE RECORDING SHEET

Scorekeeper's Name: _____

Cadet Name:	Lane	Shots Fired			X = Miss	Misses	Comments/Penalties
		3 Spare	3 Spare	3 Spare			
Cadet Name:	Lane				X = Miss	Misses	
Cadet Name:	Lane				X = Miss	Misses	
Cadet Name:	Lane				X = Miss	Misses	
Cadet Name:	Lane				X = Miss	Misses	
Cadet Name:	Lane				X = Miss	Misses	
Cadet Name:	Lane				X = Miss	Misses	
Cadet Name:	Lane				X = Miss	Misses	
Cadet Name:	Lane				X = Miss	Misses	
Cadet Name:	Lane				X = Miss	Misses	
Cadet Name:	Lane				X = Miss	Misses	
Cadet Name:	Lane				X = Miss	Misses	
Cadet Name:	Lane				X = Miss	Misses	
Cadet Name:	Lane				X = Miss	Misses	
Cadet Name:	Lane				X = Miss	Misses	

Figure B-3 Range Recording Sheet

D Cds 3, 2006, Ottawa, ON: Department of National Defence

THIS PAGE INTENTIONALLY LEFT BLANK

SAMPLE STRETCHES

NECK

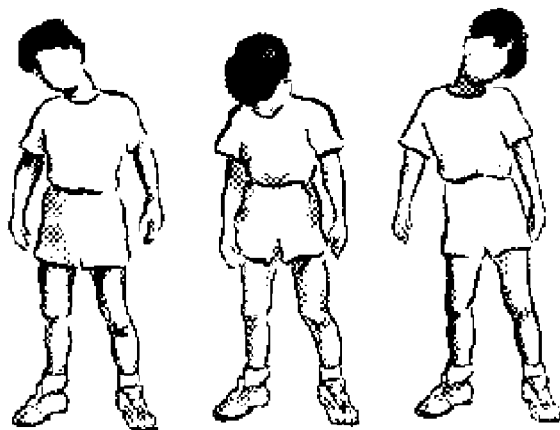


Figure C-1 Neck Stretch

Moving on the Spot: A Collection of 5-Minute Stretch and Movement Sessions, by B. Hanson, 1999, Toronto, Ontario: Toronto Public Health. Retrieved 26 October 2006, from <http://www.lin.ca/resource/html/dn3.htm#1>

Slowly roll your head across your chest from shoulder to shoulder. Do not roll your head backwards.

SHOULDERS



Figure C-2 Shoulder Push

Moving on the Spot: A Collection of 5-Minute Stretch and Movement Sessions, by B. Hanson, 1999, Toronto, Ontario: Toronto Public Health. Retrieved 26 October 2006, from <http://www.lin.ca/resource/html/dn3.htm#1>

Stand and extend your arms behind you, interlocking your fingers. Push up and back with your shoulders. Hold this position for a minimum of 10 seconds.

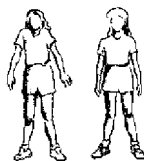


Figure C-3 Shoulder Shrug

Moving on the Spot: A Collection of 5-Minute Stretch and Movement Sessions, by B. Hanson, 1999, Toronto, Ontario: Toronto Public Health. Retrieved 26 October 2006, from <http://www.lin.ca/resource/html/dn3.htm#1>

Stand and raise your shoulders as high as possible and then lower your shoulders, stretching your neck up. Pull your shoulders back as far as possible and then round your shoulders forward by pushing your shoulders forward as far as possible. Hold each position for a minimum of 10 seconds.



Figure C-4 Arm Circles

Warm Ups, by Martha Jefferson Hospital, Copyright 2001 by Martha Jefferson Hospital. Retrieved 26 October 2006, from <http://www.marthajefferson.org/warmup.php>

Hold your arms straight out, palms up. Make small circles with your arms, gradually increasing the size.
Reverse the direction of your circles.



Figure C-5 Shoulder Stretch

Smart Start: A Flexible Way to Get Fit. Retrieved 26 October 2006, from <http://www.in-motion.ca/walkingworkout/plan/flexibility/>

Either standing or sitting, take your right arm in your left hand and bring it across your chest, supporting the joint by holding it behind the elbow. Pull the elbow lightly towards your chest. You should feel the stretch in your right shoulder.

Hold this position for a minimum of 10 seconds and repeat on the opposite side.

ARMS



Figure C-6 Wrist Rotations

Exercises. Copyright 1998 by Impacto Protective Products Inc. Retrieved 26 October 2006, from <http://www.2protect.com/home.htm>

Rotate your hands in circular motions at the wrist.
Change direction and repeat on both sides.



Figure C-7 Triceps Stretch

Smart Start: A Flexible Way to Get Fit. Retrieved 26 October 2006, from <http://www.in-motion.ca/walkingworkout/plan/flexibility/>

Stand and bring your right arm over your head, bent at the elbow. Use your left hand to gently pull your arm down.

Hold this position for a minimum of 10 seconds and repeat on the opposite side.



Figure C-8 Forearm Stretch

Exercise Programme for Squash, Tennis, Softball, Handball. Retrieved 26 October 2006, from <http://www.physionline.co.za/conditions/article.asp?id=49>

In a kneeling position, place your hands on the floor in front of you with your fingers pointing toward your knees, and your thumbs pointing out. Keeping your hands flat on the floor, lean back. Hold this position for a minimum of 10 seconds.

CHEST AND ABDOMINALS



Figure C-9 Chest Stretch

Smart Start: A Flexible Way to Get Fit. Retrieved 26 October 2006, from <http://www.in-motion.ca/walkingworkout/plan/flexibility/>

Stand facing a wall. With your right arm bent and your elbow at shoulder height, place your palm against the wall. Turn your body away from your right arm. You should feel the stretch on the front side of your armpit and across the front of your chest.

Hold this position for a minimum of 10 seconds and repeat on the opposite side.



Figure C-10 Side Stretch

Moving on the Spot: A Collection of 5-Minute Stretch and Movement Sessions, by B. Hanson, 1999, Toronto, Ontario: Toronto Public Health. Retrieved 26 October 2006, from <http://www.lin.ca/resource/html/dn3.htm#1>

Stand with your left arm up over your head. Bend at the waist towards the right side of your body.

Hold this position for a minimum of 10 seconds and repeat on the opposite side.

BACK



Figure C-11 Lower Back Stretch

Smart Start: A Flexible Way to Get Fit. Retrieved 26 October 2006, from <http://www.in-motion.ca/walkingworkout/plan/flexibility/>

Lie on your back and bring your knees toward your chest. Grasp the back of your knees. Hold this position for a minimum of 10 seconds.

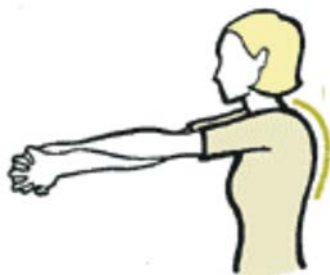


Figure C-12 Upper Back Stretch

Smart Start: A Flexible Way to Get Fit. Retrieved 26 October 2006, from <http://www.in-motion.ca/walkingworkout/plan/flexibility/>

Extend your arms straight in front of you at shoulder height crossing one arm over the other. With the palms facing each other, intertwine your fingers and press out through your arms. Let your chin fall to your chest as you exhale. You should feel the stretch in the upper back.

Hold this position for a minimum of 10 seconds and repeat on the opposite side.

LEGS



Figure C-13 Hamstring Stretch

Smart Start: A Flexible Way to Get Fit. Retrieved 26 October 2006, from <http://www.in-motion.ca/walkingworkout/plan/flexibility/>

Lie flat on the floor with your knees bent and your back flat on the floor. Slowly raise and straighten one leg, grasping it behind your thigh with both hands. Hold this position for a minimum of 10 seconds.



Figure C-14 Inner Thigh Stretch

Smart Start: A Flexible Way to Get Fit. Retrieved 26 October 2006, from <http://www.in-motion.ca/walkingworkout/plan/flexibility/>

Sit on the floor with your knees bent and the soles of your feet together. Grab your toes and pull yourself forward while keeping your back and neck straight.

Hold this position for a minimum of 10 seconds.

Grab your ankles and push your knees down toward the floor with your elbows.

Hold this position for a minimum of 10 seconds.



Figure C-15 Hip Flexor

Smart Start: A Flexible Way to Get Fit. Retrieved 26 October 2006, from <http://www.in-motion.ca/walkingworkout/plan/flexibility/>

Kneel on your right knee. Position your left foot in front of you, bending your knee and placing your left hand on that leg for stability. Keep your back straight and abdominal muscles tight. Lean forward, shifting more body weight onto your front leg. You should feel the stretch in the front of your hip and the thigh of the leg you are kneeling on. Cushion your kneecap with a folded towel if necessary.

Hold this position for a minimum of 10 seconds and repeat on the opposite side.

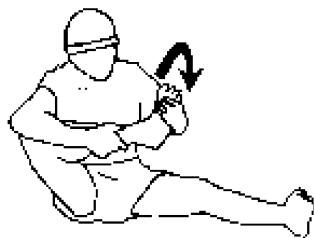


Figure C-16 Ankle Rotations

Running Exercises. Retrieved 26 October 2006, <http://www.physionline.co.za/conditions/article.asp?id=46>

From a sitting position, rotate your foot in a clockwise, and then a counterclockwise, direction.

Switch and repeat on the opposite side.



Figure C-17 Calf Stretch

Smart Start: A Flexible Way to Get Fit. Retrieved 26 October 2006, from <http://www.in-motion.ca/walkingworkout/plan/flexibility/>

Stand three steps away from and facing a wall. Step in towards the wall with your right leg, bending your right knee and keeping your left leg straight. Extending your arms with your palms forward, reach out to the wall and let your body fall toward the wall. Keep your toes forward and your heels down. Lean your body into the wall with your left leg straight behind your body. You should feel the stretch in your left calf.

Hold this position for a minimum of 10 seconds and repeat on the opposite side.



Figure C-18 Quadriceps Stretch

Smart Start: A Flexible Way to Get Fit. Retrieved 26 October 2006, from <http://www.in-motion.ca/walkingworkout/plan/flexibility/>

Stand with your hand against a wall for balance. Lift your left foot off the ground, bending your knee as if you are trying to kick your bottom with your heel. Do not lean forward at the hips. Grab and hold your ankle with your left hand. You should feel the stretch in your left thigh.

Hold this position for a minimum of 10 seconds and repeat on the opposite side.

INVITATION SAMPLE

Corps Competitive Summer Biathlon Activity

When:

Where:

Eligibility: Red Star Cadets

Rules: Located at Annex A to EO C211.04, Instructional Guide.

Event: Individual

Category: Female: three loops of 500 to 1000 m, two relays of firing in the prone position
Male: three loops of 500 to 1000 m, two relays of firing in the prone position

Schedule:

0900hrs	Coaches meeting
1010hrs	Start
1055hrs	Last cadet start
1200hrs	Last cadet finish
1300hrs	Awards

Note: Times listed above are approximate.

Contact Information:

Special Notes:

Additional corps officers will be required to assist in running the competitive summer biathlon activity.

Parents and spectators are invited to observe the activity.

THIS PAGE INTENTIONALLY LEFT BLANK

AWARDS INSTRUCTIONS

AWARDS

All cadets shall be awarded with a certificate/ribbon for participation. The top three competitors from each gender shall be awarded with a certificate/ribbon/medal.

AWARD CEREMONY

The technical delegate shall organize the award ceremony for the competitive summer biathlon activity.

AWARD PRESENTATIONS

The hosting corps Commanding Officer or other local VIP shall present awards to the winning cadets and certificates to all cadets.

THIS PAGE INTENTIONALLY LEFT BLANK



**COMMON TRAINING
ALL TRAINING LEVELS
INSTRUCTIONAL GUIDE**



CANADIAN ARMED FORCES (CAF) FAMILIARIZATION

SECTION 1

PO X20 – PARTICIPATE IN CAF FAMILIARIZATION

Total Time:

For the following EOs, refer to the lesson specifications located in A-CR-CCP-701/PG-001, *Royal Canadian Army Cadets Green Star Qualification Standard and Plan*:

- MX20.01A – Participate in a CAF Activity,
- MX20.01B – Participate in a CAF Familiarization Tour,
- MX20.01E – Attend a CAF Presentation,
- MX20.01F – Attend a CAF Commemorative Ceremony, and
- CX20.01 – Participate in CAF Familiarization Activities.

For the following EOs, refer to the instructional guides located in A-CR-CCP-701/PF-001, *Royal Canadian Army Cadets Green Star Instructional Guides*:

- MX20.01C – Fire the C7 Rifle,
- MX20.01D – Participate in a Mess Dinner,
- MX20.01G – Participate in CAF Familiarization Video Activities, and
- MX20.01H – Participate in CAF Familiarization Learning Stations.

THIS PAGE INTENTIONALLY LEFT BLANK



ROYAL CANADIAN ARMY CADETS

RED STAR

INSTRUCTIONAL GUIDE



SECTION 1

EO M221.01 – PERFORM THE DUTIES OF A SECTION MEMBER IN THE FIELD

Total Time: 30 min

PREPARATION

PRE-LESSON INSTRUCTIONS

Resources needed for the delivery of this lesson are listed in the lesson specification located in A-CR-CCP-702/PG-001, Chapter 4. Specific uses for said resources are identified throughout the Instructional Guide within the TP for which they are required.

Review the lesson content and become familiar with the material prior to delivering the lesson.

PRE-LESSON ASSIGNMENT

N/A.

APPROACH

An interactive lecture was chosen for this lesson to give direction on procedures to take as a section member on a weekend bivouac FTX.

INTRODUCTION

REVIEW

N/A.

OBJECTIVES

By the end of this lesson the cadet shall be expected to perform the duties of a section member in the field.

IMPORTANCE

It is important for cadets to know their role as a section member in a field environment. On a weekend bivouac FTX, section members will be given small leadership roles within their peer groups to assist with common duties such as setting up the bivouac site, maintaining safety and assisting other cadets.

Teaching Point 1**Discuss Environmental Considerations When Setting up a Bivouac Site**

Time: 5 min

Method: Interactive Lecture



Discuss the listed risks to consider in the field when setting up a bivouac site.

ENVIRONMENTAL CONSIDERATIONS

Fallen Trees/branches. Fallen trees/branches will minimize building effort when setting up a bivouac site. These trees and branches can be used for many components of the site. Fallen trees can mark boundaries, hold signs, and help weatherproof a site. However, care must be taken as cadets can easily trip over fallen trees/branches. A sharp branch can also cause damage to equipment such as tents and ground sheets. Tent sites should not be set up where fallen trees are present.

Dead Trees. Areas with dead trees should be avoided. These trees can easily fall during high winds and storms. Look closely for any branches that may fall. Dead trees lack strength and therefore should not be relied on in bivouac building efforts.

Poisonous Plants. Always look for poisonous plants prior to setting up a bivouac site. Common poisonous plants such as poison ivy, poison sumac and poison oak were identified in EO M121.05 (Recognize Environmental Hazards). Contact with poisonous plants causes severe itching of the skin, red inflammation and blistering. Contact should be avoided.

INSECT RISKS

Beehives and Hornet's Nests. In the field, beehives and hornet nests can be found in trees, shrubs and even in the ground. When nests are disturbed, bees and hornets will get defensive and sting. Always look for beehives and hornet's nests before setting up a site. A good sign that a hive or nest is nearby is when a large number of bees or hornets are flying around.



Figure 1 Hornet's Nest

Tawrell, P., Camping and Wilderness Survival, Leonard Paul Tawrell (p. 898)

Ant Hills. Once disturbed, ant hills can become a big nuisance. Check the ground for ant hills prior to setting up a bivouac site.



Figure 2 Ant Hill

Tawrell, P., Camping and Wilderness Survival, Leonard Paul Tawrell (p. 898)

ANIMAL RISKS

Small Trails. It is fairly common to see animals on small trails when in the field. When setting up a bivouac site, ensure that the site does not fall at the end of a trail. This could lead to an unexpected visit from animals. Small trails may lead to dens and watering holes.

Dens. Prior to setting up a bivouac site, look for any areas that may be near animal dens. A group of cadets could easily disturb resting animals. A den may be found on a trail or at the end of a trail in the field.

Watering Holes. Just like humans, animals need water. Bivouac sites should be near water; however, not too close. Sites should be set up approximately 60 m from water. When in the field, water sources can become contaminated very easily. Soap and feces are two of the most common sources. Distancing the bivouac site is also an important step to ensure that contaminants do not pollute the water.

CONFIRMATION OF TEACHING POINT 1

QUESTIONS

- Q1. What are some common environmental risks to consider when selecting a bivouac site?
- Q2. In the field, where are beehives and hornet nests usually found?
- Q3. What are some indications that animals may be close by?

ANTICIPATED ANSWERS

- A1. Fallen trees/branches, dead trees, and poisonous plants.
- A2. Beehives and hornet's nests can be found in trees, shrubs and even in the ground.
- A3. Small trails, dens and watering holes.

Teaching Point 2**Discuss Maintaining a Safe Site**

Time: 8 min

Method: Interactive Lecture



A well organized and clean bivouac site is especially important with respect to safety, particularly if the weather gets bad or if there is an emergency.

Discuss some of the simple steps that section members can follow to help ensure a safe site is maintained when in the field.

DISTANCE BETWEEN SHELTERS

There may be many cadets in the field at any given time. It is important that shelters are spread out through both the male and female lines. Shelters should be spaced at least two metres apart. Where guy lines exist, there must be adequate space between shelters so that cadets can easily walk without stepping over lines.

By spacing shelters a small distance, cadets are provided with privacy, while still being able to easily communicate.



When night falls, shelters may be hard to see. When shelters are close together there is a greater chance of having an accident, such as tripping over guy lines.

MARKING THE BIVOUAC LAYOUT

Red Star cadets may be expected to assist in the set-up of a bivouac site.

Bivouac layout was discussed in EO M121.09 (Follow Camp Routine). Clearly marking these components is a great way to make sure everyone knows where they are.

Components of a bivouac site are:

- headquarters;
- first aid point;
- supply;
- toilets;
- wash station;
- mess/eating area;
- fire pit;
- fire point;
- in/out route for the safety vehicle;

- form-up area;
- food hang;
- vehicle parking area;
- drinking water point;
- petroleum, oils, and lubricants (POL) point;
- female/male quarters; and
- garbage point.

The following figure is a sample bivouac site.

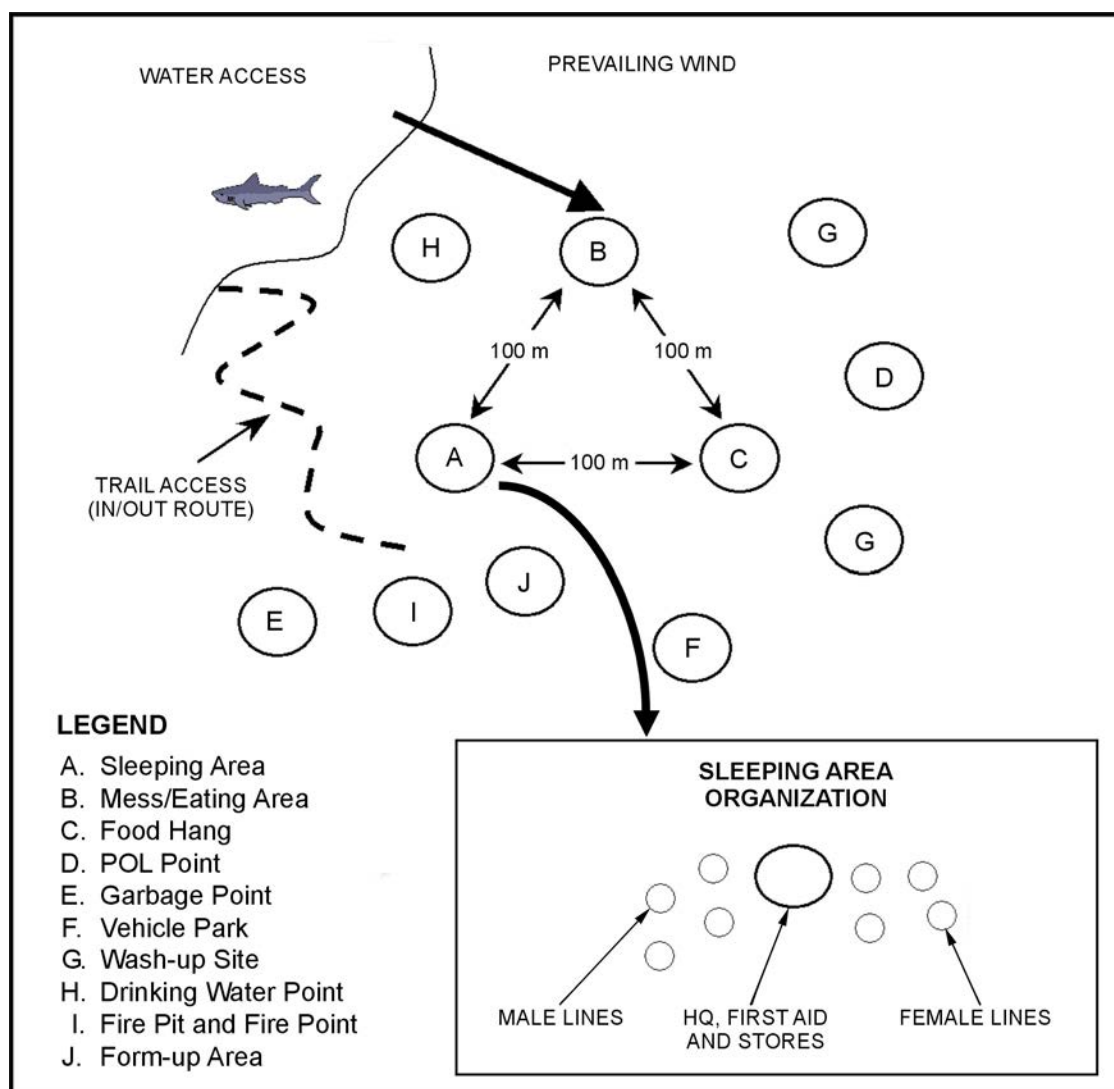


Figure 3 Sample Bivouac Site

D CdtS 3, 2007, Ottawa ON: Department of National Defence



Areas that will be used after dark should be lit using glow sticks, lanterns or flashlights.

FIRE PROCEDURES



Upon arrival to a bivouac site, fire procedures will be explained in the safety briefing. It is extremely important that all cadets know and understand the cadet corps' fire procedures.

The fire pit, cooking area, POL point and supply are the areas with the highest risk of fire. All cadets must know where they are located along with actions to take if a fire occurs.

Fire procedures will differ depending on the location of the weekend bivouac FTX. For example, if the bivouac area is in a recognized park, the cadet corps must follow the park's fire procedures. If the bivouac area is on private property, the cadet corps will be expected to follow their established fire procedures.

ASSIST OTHER CADETS



Section members are naturally given leadership opportunities. Assisting other cadets is a key step in the development of leadership in the field.

Though Red Star cadets will not be given an abundance of opportunities to supervise others, there are some basic aspects of field training in which they can assist.

Supervision ensures **safety**. When tasks are being completed, an effective team will work together and assist each other.

Though Red Star cadets are not expected to supervise, as a section member in the field, they can assist their peers and the Green Star cadets in following camp routine.

Section members can assist by:

- setting up the components of the bivouac site;
- ensuring that all cadets know the bivouac layout;
- making sure that all drinking water is coming from drinking water points;
- storing and disposing of all garbage properly; and
- practicing safe behaviour individually and as a group.

CONFIRMATION OF TEACHING POINT 2

QUESTIONS

- Q1. What points should be considered in order to maintain a safe site?
- Q2. What components of a bivouac site have the highest risk of fire?
- Q3. What is the purpose of supervision?

ANTICIPATED ANSWERS

- A1. Shelters should have approximately two metres between them; bivouac components should be clearly marked; everyone should know the applicable fire procedures; and all cadets should be supervised and assisted whenever possible.
- A2. The fire pit, cooking area, POL point and supply area.
- A3. The purpose of supervision is safety.

Teaching Point 3**Discuss the Importance of Individual and Group Hygiene**

Time: 7 min

Method: Interactive Lecture



By elaborating on the importance of these points, the cadets will begin to understand their role as a section member with the cadet corps. Individual and group hygiene are very important in the field. The cadets can positively influence younger cadets by setting a good example.

CHANGE CLOTHES REGULARLY

It is important to keep all clothing, especially underclothing and socks, as clean and dry as possible. Clothing, as well as the body, must stay clean and dry. Keeping clothes clean will lessen the chances of exposure to rashes and infections. Change clothes, especially socks and undergarments, regularly.

PROPERLY DISPOSE OF WASTE WATER

There will always be a quantity of waste water from personal bathing and cooking in the field.

Follow these steps to properly dispose of waste water.

1. Collect all large particles with a food strainer or cloth and place in the garbage.
2. Place the remaining waste water in a container.
3. Dig a small hole at least 60 m away from any water source.
4. Pour the waste water in the hole.
5. Fill in the hole with natural materials.

WASH REGULARLY

In order to minimize the spread of diseases, hand washing should be enforced when in the field. There are two common approaches to hand washing – hand sanitizers and soap and water.

It is important to always keep the hands clean. Having hand sanitizer is very convenient. When hand sanitizer is not available, use soap and water. Remember to dispose of all waste water.

Washing the body is very important and should be done daily. Pay special attention to areas of the body that are susceptible to rash and fungus infection (the scalp, the crotch, and between the toes).

USE DESIGNATED ABLUTION SITES

Outhouses and chemical toilets should be utilized whenever possible.

Disposing of waste must be done using good judgement and common sense. In an emergency:

- Always urinate at least 60 m away from trails and water sources. Urine will leave a smell and will attract animals once it evaporates.
- Feces can create a significant impact on the environment. Feces can contaminate water sources, spread disease, and affect others both visually and by smell.



Human waste should be deposited in cat holes dug 16 to 20 cm deep and at least 60 m away from water sources, camps and trails. Mix feces with some soil, using a small stick. Cover and disguise the cat hole when finished. Toilet paper should be packed out.

TREAT INJURIES AS SOON AS THEY OCCUR



Serious injuries should be immediately treated by a qualified first aider.

It is relatively easy for minor wounds to occur in a field setting. Injuries have the potential to become infected and it is important to know what to do as soon as these injuries occur.

On the spot treatment for injuries depends on the injury itself, knowledge and training of the people involved, medical materials present, the environment, correct diagnosis of the problem, and the ability to work under strained conditions.

Minor injuries are discussed further in EO M221.04 (Perform Basic First Aid).

CONFIRMATION OF TEACHING POINT 3

QUESTIONS

- Q1. Why is it important to keep clothes clean?
- Q2. What are the steps to properly dispose of waste water?
- Q3. How can one minimize the spread of diseases?

ANTICIPATED ANSWERS

- A1. Keeping clothes clean will lessen the chances of rashes and infections.
- A2. Follow these steps to properly dispose of waste water.
 1. Collect all large particles with a food strainer or cloth and place in the garbage.
 2. Place the remaining waste water in a container.
 3. Dig a small hole at least 60 m away from any water source.
 4. Pour the waste water in the hole.
 5. Fill in the hole with natural materials.
- A3. Wash hands regularly.

Teaching Point 4**Discuss Receiving, Caring for, and Returning Equipment**

Time: 5 min

Method: Interactive Lecture



Cadets must know the importance of taking care of equipment. When equipment is not properly taken care of, performance is compromised and life of the equipment becomes shorter.

Stress the impact and importance of the following points.

RECEIVING, CARING FOR, AND RETURNING EQUIPMENT

Section equipment is normally stored either within the section or by the quartermaster when in the field. Section equipment, also referred to as stores, includes stoves, lanterns, pot sets, tents, water containers, etc.

When drawing stores, the following points shall be kept in mind:

- Equipment should be signed out only through the designated quartermaster (the designated quartermaster may be a section commander or supply officer).
- Equipment shall always be kept clean when not in use.
- Equipment shall be secured and stored when not in use. The performance of equipment is a vital part of a successful weekend bivouac FTX. Improper securing and storing contributes to loss of durability and a shorter life of the equipment.
- Any equipment loss/damage shall be reported to the designated quartermaster as soon as it occurs or is noticed.
- Equipment shall be returned to the designated quartermaster.

CONFIRMATION OF TEACHING POINT 4**QUESTIONS**

- Q1. Why should equipment be secured when not in use?
- Q2. Who signs in/out equipment?
- Q3. When should equipment loss/damage be reported?

ANTICIPATED ANSWERS

- A1. The performance of equipment is a vital part of a successful weekend bivouac FTX. Improper securing and storing contributes to loss of durability and a shorter life of the equipment.
- A2. Equipment is signed in/out through the designated quartermaster.
- A3. Equipment loss/damage should be reported as soon as it occurs or is noticed.

END OF LESSON CONFIRMATION

QUESTIONS

- Q1. What types of risks should be considered when setting up a bivouac site?
- Q2. How can section members supervise and assist other cadets in following camp routine?
- Q3. How can one minimize the spread of diseases?

ANTICIPATED ANSWERS

- A1. Environmental, insect and animal.
- A2. Section members can supervise and assist by:
- ensuring that all cadets know the bivouac layout;
 - making sure that all drinking water is coming from drinking water points;
 - storing and disposing of all garbage; and
 - practicing safe behaviour individually and as a group.
- A3. Wash hands regularly.

CONCLUSION

HOMEWORK/READING/PRACTICE

N/A.

METHOD OF EVALUATION

N/A.

CLOSING STATEMENT

As section members, the cadets are expected to assist with common duties. It is important to know what is expected of a section member so that every section member knows their place in the cadet corps while on a weekend bivouac FTX.

INSTRUCTOR NOTES/REMARKS

N/A.

REFERENCES

A0-036 A-CR-CCP-121/PT-001 D Cdts 3 (2000). *Royal Canadian Army Cadet Reference Book*. Ottawa, ON: Department of National Defence.

C0-111 (ISBN 978-0-9740820-2-3) Tawrell, P. (2006). *Camping and Wilderness Survival: The Ultimate Outdoors Book* (2nd ed.). Lebanon, NH: Leonard Paul Tawrell.

C2-016 (ISBN 0-517-88783-5) Curtis, R. (1998). *The Backpackers Field Manual: A Comprehensive Guide to Mastering Backcountry Skills*. New York, NY: Three Rivers Press.



ROYAL CANADIAN ARMY CADETS

RED STAR

INSTRUCTIONAL GUIDE



SECTION 2

EO M221.02 – IDENTIFY SECTION EQUIPMENT

Total Time:

60 min

PREPARATION

PRE-LESSON INSTRUCTIONS

Resources needed for the delivery of this lesson are listed in the lesson specification located in A-CR-CCP-702/PG-001, Chapter 4. Specific uses for said resources are identified throughout the Instructional Guide within the TP for which they are required.

Review the lesson content and become familiar with the material prior to delivering the lesson.

All items listed in each TP should be available when instructing this lesson. It is understood that some items will be unavailable due to local resource limitations.

Prepare a first aid kit for demonstration. Ensure it is fully equipped IAW A-CR-CCP-951/PT-002, *Royal Canadian Army Cadets Adventure Training Standards*.

PRE-LESSON ASSIGNMENT

N/A.

APPROACH

An interactive lecture was chosen for this lesson to identify section equipment, introduce a new subject and to present the different types of equipment available when participating in a weekend bivouac FTX.

INTRODUCTION

REVIEW

N/A.

OBJECTIVES

By the end of this lesson the cadet shall be expected to identify section equipment.

IMPORTANCE

It is important for cadets to know what equipment is available when going on a weekend bivouac FTX. Having knowledge of the equipment available and its uses allows cadets to prepare for a weekend bivouac FTX. The items selected can be tailored to meet the objective of the weekend bivouac FTX.

Teaching Point 1**Identify Types of Stoves and Lanterns**

Time: 15 min

Method: Interactive Lecture



This TP is intended to give an overview of the different equipment available when selecting equipment for camping and trekking/hiking.

Provide cadets with an example of each item. Allow cadets to see the equipment up close and handle it carefully.

TYPES OF FUEL BURNING SYSTEMS

The options of available camping and trekking/hiking equipment are vast and vary depending on the manufacturer. There are three basic types of fuel burning systems, which are based on what they burn – liquid fuel, compressed gas and solid fuel.

Liquid Fuel. Liquid fuel stoves burn white gas—kerosene, alcohol or naphtha. They are the best choice for extremely cold conditions and high altitudes. The fuel is stored in a separate tank. In most cases, this tank uses a pump to help pressurize it. The tank should be filled only to the 3/4 point, leaving some air in the tank. Kerosene, alcohol or naphtha are cleaner fuels that leave little residue when burned.

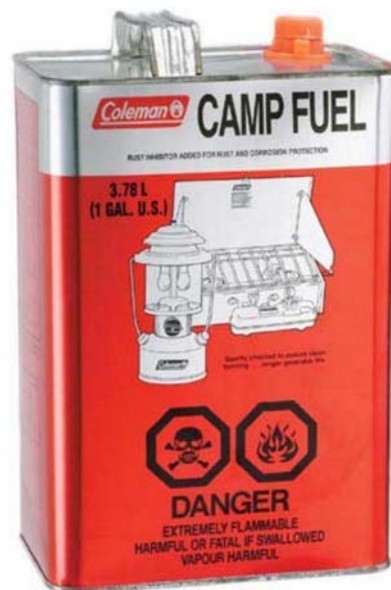


Figure 1 Coleman Naphtha Fuel

Canadian Tire, Copyright 1997-2007 by Canadian Tire Corporation Limited.

Retrieved 24 April 2007, from =1408474396672290&PRODUCT%3C

%3Eprd_id=845524443280741&bmUID=1177356005717&assortment=primary&fromSearch=true

Naphtha Fuel HYPERLINK "http://www.canadiantire.ca/browse/product_dei"

Compressed Gas. Compressed gas stoves burn butane, isobutene or propane. They are easy to turn on and off and require little maintenance. The heat produced is controlled easily and both the fuel and fuel canister are lighter than liquid fuel stoves. Compressed gas stoves do not work very well in cold temperatures. It is difficult to determine the amount of fuel remaining after use because the fuel is stored in a solid vessel.



Figure 2 Compressed Gas

Canadian Tire, Copyright 1997-2007 by Canadian Tire Corporation Limited. Retrieved 24 April 2007, from http://www.canadiantire.ca/browse/product_detail.jsp?FOLDER%3C%3Efolder_id=1408474396672290&bmUID=1178201728250&PRODUCT%3C%3Eprd_id=845524443280741&assortment=primary&fromSearch=true



Figure 3 Compressed Gas

Mountain Equipment Coop, Copyright 2007 by Mountain Equipment Coop. Retrieved 24 April 2007, from http://www.mec.ca/Products/product_detail.jsp?PRODUCT%3C%3Eprd_id=845524441775741&FOLDER%3C%3Efolder_id=2534374302696497&BMUID=1178201628346

Solid Fuel. Solid fuel burns flammable pellets, cubes or wood. These systems are simple and easy to use. Regulating temperature is hard at times as they commonly only burn what is added to them. There is little to no maintenance required on these stoves.

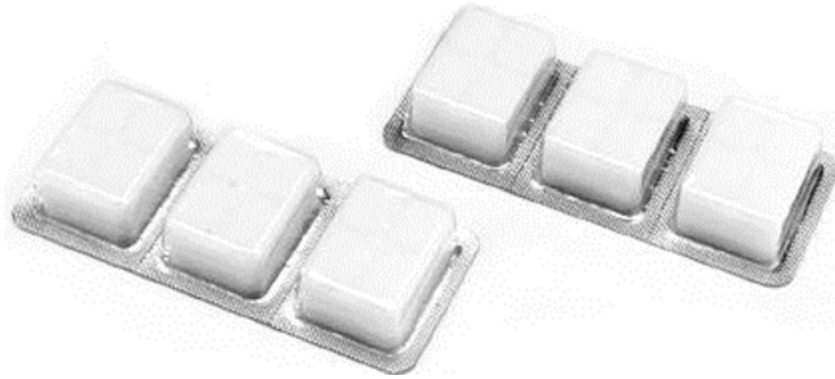


Figure 4 Esbit Stove Fuel

*Backpackgear Online.com, Copyright 2007 by Maguire and Johnson Web Services.
Retrieved 28 March 2007, from [http://www.mjsecure.com/backpackgearonline/
product_info.php?cPath=27&products_id=330&osCsid=dc36e4f96e5105dacd461c37f0788f17](http://www.mjsecure.com/backpackgearonline/product_info.php?cPath=27&products_id=330&osCsid=dc36e4f96e5105dacd461c37f0788f17)*

CAMPING STOVES

Single-burner. Single-burner stoves are portable stoves that allow one to cook anywhere without having to make a fire. These stoves store easily and can be carried along a trek with ease. Fuel is carried in a separate container to ensure there is no spillage of fuel in the pack.



Figure 5 Single-burner Coleman Stove

*Backpackgear Online.com, Copyright 2007 by Maguire and Johnson Web Services. Retrieved 28 March 2007,
from http://www.coleman.com/coleman/colemancom/detail.asp?product_id=533B705&categoryid=2020*



Figure 6 Single-burner MSR Stove

Mountain Equipment Coop, Copyright 2007 by Mountain Equipment Coop. Retrieved 24 April 2007, from http://www.mec.ca/Products/product_detail.jsp?PRODUCT%3C%3Eprd_id=845524441772275&FOLDER%3C%3Efolder_id=2534374302696497&bmUID=1175178016804

Two-burner. The two-burner stove is an efficient item that is particularly suited for the field. When travelling in groups, this stove can be carried in a supply vehicle or on a toboggan. This stove is equipped with two burners which can help speed up the cooking process.



Figure 7 Coleman Powerhouse Naphtha Two-burner Stove

Coleman Outdoor Company, Copyright 2006 by The Coleman Company, Inc. Retrieved 28 March 2007, from http://www.coleman.com/coleman/colemancom/detail.asp?product_id=425G499&categoryid=70023



Figure 8 Coleman Two-burner Propane Stove

Coleman Outdoor Company, Copyright 2006 by The Coleman Company, Inc. Retrieved 28 March 2007, from http://www.coleman.com/coleman/colemancom/detail.asp?product_id=5466A700&categoryid=70022

LANTERNS

Lanterns are designed to produce light. Each type of lantern will produce different amounts of light and last for many hours.

Single-mantle. Single-mantle lanterns which burn naphtha are clean. They can produce a dim, soft light and can burn bright like a beacon when required. The flame is adjustable and fuel consumption can range. This depends on the model type and light setting.

Dual-mantle. Dual-mantle lanterns burn naphtha. They produce more light than a single-mantle lantern. A soft light/glow can be produced and it is capable of burning bright like a beacon when required. The flame is adjustable and fuel consumption can range depending on the model type and light setting.

Battery-powered. Battery-powered lanterns provide a light that radiates from a centre bulb. The lantern has reflective surfaces above and below the light – reflecting light upward and outward. Bulbs and batteries are easily replaceable. These lanterns will run approximately 4 hours or more depending on model type.



Figure 9 Single-mantle Naphtha Lantern

Coleman Outdoor Company, Copyright 2006 by The Coleman Company, Inc. Retrieved 28 March 2007, from http://www.coleman.com/coleman/colemancom/detail.asp?product_id=288B700&categoryid=1015



Figure 10 Dual-mantle Naphtha Lantern

Coleman Outdoor Company, Copyright 2006 by The Coleman Company, Inc. Retrieved 28 March 2007, from http://www.coleman.com/coleman/colemancom/detail.asp?product_id=288B700&categoryid=1015



Figure 11 Mini Pack-away Battery Lantern

Coleman Outdoor Company, Copyright 2006 by The Coleman Company, Inc. Retrieved 28 March 2007, from http://www.coleman.com/coleman/colemancom/detail.asp?product_id=5315J725&categoryid=1045

CONFIRMATION OF TEACHING POINT 1

QUESTIONS

- Q1. What are the three types of fuel burning systems?
- Q2. What types of lanterns are there?
- Q3. What type(s) of fuel is used by a white gas system?

ANTICIPATED ANSWERS

- A1. Liquid, compressed and solid.
- A2. Single-mantle, dual-mantle, and battery-powered.
- A3. Kerosene, alcohol or naphtha.

Teaching Point 2

Identify Types of Field Tools

Time: 10 min

Method: Interactive Lecture



This TP is intended to give an overview of the different equipment available when selecting equipment for camping and trekking/hiking.

Provide cadets with an example of each item. Allow cadets to see the equipment up close and handle it carefully.

SINGLE-BIT AXE

The single-bit axe has a sharp, fully polished, tempered steel head. The axe handle inserts into the axe head also known as the single-bit. The axe requires very little maintenance—only sharpening when the blade is dull and occasionally adding a few drops of oil to prevent rusting. This tool may be used for cutting or splitting wood.



Figure 12 Single-bit Axe

D Cdts 3, 2007, Ottawa, ON: Department of National Defence

BOW SAW

The bow saw is a metal-framed saw in the shape of a bow with a coarse wide blade. It is mostly used for cutting trees and branches. The blade is toothed and suspended between two long narrow handles called “cheeks”.



Figure 13 Bow Saw

D Cdts 3, 2007, Ottawa, ON: Department of National Defence

CONFIRMATION OF TEACHING POINT 2

QUESTIONS

- Q1. What is a single-bit axe used for?
- Q2. What is the head of an axe made of?
- Q3. What is a bow saw and why is it used?

ANTICIPATED ANSWERS

- A1. A single-bit axe is a tool that is used for cutting or splitting wood.
- A2. The axe head is made of tempered steel.
- A3. The bow saw is a metal-framed saw in the shape of a bow with a coarse wide blade. It is mostly used for cutting trees and branches.

Teaching Point 3

Identify Liquid Storage Vessels

Time: 10 min

Method: Interactive Lecture



This TP is intended to give an overview of the different equipment available when selecting equipment for camping and trekking/hiking.

Provide cadets with an example of each item. Allow cadets to see the equipment up close and handle it carefully.

STOVE AND LANTERN FUEL VESSELS



Figure 14 Fuel Container

Mountain Equipment Coop, Copyright 2007 by Mountain Equipment Coop. Retrieved 28 March 2007, from http://www.mec.ca/Products/product_detail.jsp?PRODUC%3C%3Eprd_id=845524441772275&FOLDER%3C%3Efolder_id=2534374302696497&bmUID=1175178016804



Figure 15 Fuel Container

Mountain Equipment Coop, Copyright 2007 by Mountain Equipment Coop. Retrieved 28 March 2007, from http://www.mec.ca/Products/product_detail.jsp?FOLDER%3C%3Efolder_id=2534374302696497&PRODUCT%3C%3Eprd_id=845524442413091&bmUID=1175621430159



Figure 16 Fuel Container

Mountain Equipment Coop, Copyright 2007 by Mountain Equipment Coop. Retrieved 28 March 2007, from http://www.mec.ca/Products/product_detail.jsp;jsessionid=GSTxtlCM69T22xGcCGVwLn2T2Y83jV2cYHTJTXFIRIsGXMdYq0LC!-384445592?FOLDER%3C%3Efolder_id=2534374302696497&PRODUCT%3C%3Eprd_id=845524441776153&bmUID=1175621361170

Fuel containers for backpacking are either plastic or aluminium. Aluminium containers are usually a cylindrical aluminium bottle. Once a container is used for a particular type of fuel it should not be used for another fuel, as the substances may combine and deteriorate the container.

Plastic bottles are usually red in colour and are coated with a fluoropolymer inner coating that resists both gasoline and alcohol. Plastic fuel bottles should never be used as a tank for a stove or be pressurized with a pump.

WATER CONTAINER/CARRIER

Carrying water for a short day hike is usually no problem—one only requires a lightweight water bottle with a tight lid. When camping, a larger storage container is required.

Water Bottle. A water bottle may be used for any type of hike. Versatile equipment benefits the user. Choose bottles that can withstand the temperatures of freezing cold or boiling hot liquids.



Figure 17 Water Canteen

D Cds 3, 2007, Ottawa, ON: Department of National Defence



Figure 18 Nalgene Water Bottle

Mountain Equipment Coop, Copyright 2007 by Mountain Equipment Coop. Retrieved 28 March 2007, from http://www.mec.ca/Products/product_detail.jsp?PRODUCT%3C%3Eprd_id=845524442500177&FOLDER%3C%3Efolder_id=2534374302696609&bmUID=1177425692300

Water Carrier Bag. Water carrier bags are convenient for long treks where there is no water and for carrying water from a source to a campsite. Small bags are useful as they can be balanced on different parts of one's pack. Water bags can carry up to several litres of water.



Figure 19 MSR Water Bag

Mountain Equipment Coop, Copyright 2007 by Mountain Equipment Coop. Retrieved 24 April 2007, from http://www.mec.ca/Products/product_detail.jsp?PRODUCT%3C%3Eprd_id=845524441772631&FOLDER%3C%3Efolder_id=2534374302696609&bmUID=1177427868771

Jerry Can. A jerry can is a large water container that has a capacity of 20 L. This container is either green or black in colour and is identified with the word 'water', as seen in Figure 20.



Figure 20 Black and Green Jerry Can

D Cds 3, 2007, Ottawa, ON: Department of National Defence

CONFIRMATION OF TEACHING POINT 3

QUESTIONS

- Q1. Containers of what two materials can store fuel?
- Q2. What colour is a jerry can?
- Q3. What is the capacity of a jerry can?

ANTICIPATED ANSWERS

- A1. Aluminium and plastic containers can store fuel.
- A2. A jerry can is black or green.
- A3. A jerry can holds 20 L of water.

Teaching Point 4

Identify the Contents of a First Aid Kit

Time: 15 min

Method: Interactive Lecture



This TP is intended to give an overview of a first aid kit. Lay out all items in the first aid kit and discuss each as listed.

FIRST AID KIT

When travelling with a group, carry a first aid kit of appropriate size and type for the group and the activities expected. The first aid kit must be readily available during training and must be carried with every group at all times.

Commercially available first aid kits are useful, but the contents need to be tailored for the field setting. The minimum contents of a first aid kit, as listed in A-CR-CCP-951-PT-002, are listed below:

Instruments

- **One Pair of Bandage Scissors.** Scissors are essential for cutting tape and bandages.
- **One Pair of Splinter Type Forceps.** Splinter type forceps resemble tweezers, and they are used for grasping and holding (e.g. removing wood splinters).
- **12 Safety Pins (Assorted Sizes).** A safety pin is a pin with a point that is bent back to the head and is held in a guard when closed. These are used to secure bandages, etc.
- **Two Splints.** A splint is stiff rigid material may be used for holding a limb or broken bone in a fixed position.
- **One Respirator With Valve.** A respirator with a valve is an apparatus for maintaining artificial respiration. It also provides separation between the casualty and the first-aider, protecting the transmission of infections when giving rescue breaths.

Dressings

Dressings are used to cover bleeding wounds. These dressings and bandages come in various sizes and types, to include:

- 25 separately wrapped sterile adhesive bandages (25 mm x 75 mm);
- 25 separately wrapped sterile gauze compresses (101.6 mm x 101.6 mm);
- 4 separately wrapped rolls of sterile gauze bandages (50 mm x 9 m);
- 4 separately wrapped rolls of sterile gauze bandages (101.6 mm x 9 m);
- 6 triangular bandages;
- 2 rolls of 75 mm wide elastic bandages;
- 4 separately wrapped sterile compress bandages (101.6 mm x 101.6 mm);
- 1 roll of adhesive plaster (25 mm x 9 m);
- 2 rolls of 50-g cotton batting; and

Antiseptic pads

Antiseptic pads are sterile, free from contamination. They are used to clean the area surrounding a wound. Each first aid kit shall contain 25 separately wrapped antiseptic pads.

Sugar

Sugar is included in a first aid kit in the event that a diabetic becomes hypoglycemic. Hypoglycemia occurs when there is a deficiency of glucose (sugar) in the bloodstream. The sugar is either mixed with water and consumed or ingested directly.

Equipment

- **Blanket of Wool or a Moisture-proof Insulating Material.** This can be any type of wool blanket or a survival/emergency foil blanket. Only one is required and it is used to keep a casualty warm.
- **Waterproof Lighter or Matches.** Waterproof lighter or matches are useful for creating fire. Matches should not be wasted and only used when improvised methods fail.
- **Latex Gloves.** These gloves are used to provide a sterile barrier between the first-aider and the casualty. There shall be a minimum of two pairs per first aid kit.

CONFIRMATION OF TEACHING POINT 4

QUESTIONS

- Q1. Why are scissors in a first aid kit?
- Q2. What purpose does sugar serve in a first aid kit?
- Q3. Why are there latex gloves in the first aid kit?

ANTICIPATED ANSWERS

- A1. Scissors are essential for cutting tape and bandages.
- A2. Sugar is used in the event that a diabetic went hypoglycemic. Hypoglycemia occurs when there is a deficiency of glucose (sugar) in the bloodstream.
- A3. Latex gloves are in a first aid kit to provide a sterile barrier between the first-aider and the casualty.

END OF LESSON CONFIRMATION



Complete either the equipment identification or questions for this TP's confirmation.
Hold up a piece of equipment and have the cadets identify it. Do this for five more items.

QUESTIONS

- Q1. What type of fuels can be used in equipment systems?
- Q2. What is the head of an axe made of?
- Q3. When going into the field, how many groups require a first-aid kit?

ANTICIPATED ANSWERS

- A1. Liquid, compressed and solid fuel can be used in equipment systems.
- A2. The axe head is made of tempered steel.
- A3. All groups that travel independently require a first-aid kit.

CONCLUSION

HOMEWORK/READING/PRACTICE

N/A.

METHOD OF EVALUATION

N/A.

CLOSING STATEMENT

Cadets have been provided with information on various types of equipment. This information allows cadets the opportunity to tailor their selection of equipment according to the needs of any weekend bivouac FTX.

INSTRUCTOR NOTES/REMARKS

N/A.

REFERENCES

A2-001 A-CR-CCP-951/PT-002 D Cdts 3. (2006). *Royal Canadian Army Cadets Adventure Training Safety Standards*. Ottawa, ON: Department of National Defence.

C0-111 (ISBN 0-9740820-2-8) Tawrell, P. (2006). *Camping and Wilderness Survival: The Ultimate Outdoors Book* (2nd ed.). Lebanon, NH: Leonard Paul Tawrell.

C2-010 (ISBN 0-375-70323-3) Rawlins, C., and Fletcher, C. (2004). *The Complete Walker IV*. New York, NY: Alfred A. Knopf.

C2-016 (ISBN 0-517-88783-5) Curtis, R. (1998). *The Backpacker's Field Manual: A Comprehensive Guide to Mastering Backcountry Skills*. New York, NY: Three Rivers Press.

C2-042 (ISBN 0-7566-0946-1) Berger, K. (2005). *Backpacking & Hiking*. New York, NY: DK Publishing, Inc.

THIS PAGE INTENTIONALLY LEFT BLANK



ROYAL CANADIAN ARMY CADETS

RED STAR

INSTRUCTIONAL GUIDE



SECTION 3

EO M221.03 – IDENTIFY PROVINCIAL/TERRITORIAL WILDLIFE

Total Time:

60 min

PREPARATION

PRE-LESSON INSTRUCTIONS

Resources needed for the delivery of this lesson are listed in the lesson specification located in A-CR-CCP-702/PG-001, Chapter 4. Specific uses for said resources are identified throughout the Instructional Guide within the TP for which they are required.

Review the lesson content and become familiar with the material prior to delivering the lesson.

Learning stations are a form of group work, where the cadets learn by sorting through information presented. When setting up learning stations, ensure there is enough room for each cadet to be comfortable, and adequate space for writing down information. When the cadets arrive at a learning station, all information needed shall already be available. These stations should be placed closely together to minimize time for movement; however far enough apart to avoid interruptions from other groups. For this lesson, choose and set up a minimum of four learning stations for provincial/territorial wildlife.

Photocopy handouts located at Annexes A and B.

PRE-LESSON ASSIGNMENT

N/A.

APPROACH

An in-class activity was chosen for TP1 as it is an interactive way to provoke thought and stimulate interest among cadets.

An interactive lecture was chosen for TP2 to orient the cadets to potential risks of animals in the field and present background material.

INTRODUCTION

REVIEW

N/A.

OBJECTIVES

By the end of this lesson the cadet shall be expected to know characteristics of their provincial/territorial wildlife, specifically those that may be encountered when in the field.

IMPORTANCE

It is important for cadets to be able to identify the wildlife in their province/territory. There are many species of wildlife throughout Canada, and they differ in each province. While on an expedition, cadets may encounter a variety of wildlife in their natural habitats. Most conflicts between man and nature can be avoided by being able to identify wildlife and knowing their specific characteristics. All cadets should be aware of what to do when they come across wildlife in the field.

Teaching Point 1

Introduce the Cadets to Provincial/Territorial Wildlife

Time: 40 min

Method: In-Class Activity



The provincial/territorial wildlife information sheets for this activity are located at Annex A.

The provincial/territorial wildlife worksheet for this activity is located at Annex B.



Cadets should be aware of any provincial/territorial wildlife left out of this activity. If time permits, give the cadets the opportunity to read the remaining information sheets.

ACTIVITY

OBJECTIVE

The objective of this activity is to gain knowledge of some provincial/territorial wildlife that cadets may encounter when in the field.

RESOURCES

- Provincial/territorial wildlife information sheets;
- Provincial/territorial wildlife worksheets; and
- Pens/pencils.

ACTIVITY LAYOUT

Four learning stations will be set up and clearly marked for each of the chosen wildlife and will include:

- provincial/territorial wildlife information sheets, which will include:
 - the general description;
 - the habitat;
 - the diet; and
 - any unique characteristics;
- provincial/territorial wildlife worksheets; and
- pens/pencils.

ACTIVITY INSTRUCTIONS

1. Divide cadets into four groups and place each group at one of the wildlife learning stations.
2. Assign each group a leader. The group leader will be responsible for assigning tasks to fellow cadets. Each station will need a recorder and a reader.
3. Cadets will have eight minutes at each station to fill out a provincial/territorial worksheet (it is only necessary for each group to fill out one worksheet).
4. After eight minutes, the groups will rotate clockwise to the next station, where they will have another eight minutes to complete a provincial/territorial worksheet.
5. Rotate the groups through the remaining stations.
6. Have the cadets share the information they recorded from the station they have just completed with the rest of the cadets. In most cases, the groups will have recorded the same information for each station. If a group has listed different information, it will be shared after the presenting group has finished.

SAFETY

N/A.

CONFIRMATION OF TEACHING POINT 1

The cadets' participation in the activity will serve as the confirmation of this TP.

Teaching Point 2

Discuss Potential Risks of Animals in the Field

Time: 10 min

Method: Interactive Lecture



The word “attack” is referred to numerous times throughout this TP. Ensure cadets are aware that an attack is a form of violence and does not always indicate injury or harm.

Though attacks are uncommon, stress the importance of knowing what to do if the situation ever arises.

BEARS

Bear attacks are uncommon. Wild animals generally prefer to avoid human contact and bears are no exception. Most documented encounters occurred when the bear's natural avoidance behaviour shifted to aggression. This shift is normally caused from one, or a combination of, the following:

- They are suddenly surprised.
- They are protecting young or food.
- They follow food and food-like odours to humans.
- They are provoked by other animals (e.g. dogs).
- They are accustomed to people and have lost their natural fear.

The best way to live safely with bears is to avoid contact with them. There are important prevention actions that can be taken, such as:

- making noise;
- hiking in groups and mainly in the daylight;
- staying on established trails;
- using extra caution when travelling near rushing water or into the wind;
- staying in open area as much as possible; and
- disposing of garbage frequently, in designated areas.



When hiking/training in an area that has bears, always have bear spray or pepper spray on hand.

If you carry bear spray, be aware that wind, spray distance, rain, freezing temperatures, and product shelf life can all influence its effectiveness.

When a Bear Attacks

According to Parks Canada there are two kinds of attacks, based on the bear's behaviour—defensive and predatory.

Defensive Attack. This attack normally occurs when the bear is feeding, protecting its young and/or unaware of a person's presence. It attacks mainly because it sees the person as a threat. It is the most common type of attack.

Predatory Attack. This attack normally occurs when the bear is stalking a person along a trail and then attacks. It may also happen at night.

In Tawrell, P., *Camping and Wilderness Survival*, Leonard Paul Tawrell states the following actions to take when a **black bear** attacks.

- Do not play dead.
- Fight back – hit its snout, try to poke a stick in its eye, throw dirt or rocks into its eyes, do anything to distract attention.
- Do not climb a tree or run. Black bears can climb trees very fast!

In Tawrell, P., *Camping and Wilderness Survival*, Leonard Paul Tawrell states the following actions to take when a **grizzly bear** attacks.

- Play dead by lying flat on the stomach with legs spread out, cover the neck with intertwined fingers, and have elbows covering the face. Spread the legs out to prevent the bear from rolling you over.
- Do not attempt to run, as the bear can outrun you and the action of running will trigger the bear's predatory instinct.
- If the bear rolls you over, keep rolling to land on the stomach.

- At this point the bear might get bored and leave. Do not move until it is clear that the bear has left. It might only be lying nearby and resting.
- If the bear starts to lick your wounds, the attack has turned very serious and fighting back is necessary. Try hitting it on its snout or poking a stick or finger in its eyes.



There are bear-specific characteristics to note.

Black Bears. Black bears have been known to be on the lookout for “easy” calories. Once they find human food or garbage (if they are food-conditioned), they continue to seek it out from backpacks, picnic tables, coolers, etc. When accustomed to humans, their natural fear fades and they take more chances to find food.

Grizzly Bears. The most common circumstance of attack is the “sudden encounter”. To decrease chances of coming into a conflict, regularly make noise when hiking.

Polar Bears. Polar bears have been known to stalk humans as prey. They do not generally attack, but if someone is alone, they are easy prey for a hungry polar bear. When in polar bear country, a firearm is essential for safety.

WOLVES

Most people will never see a wolf; they are shy and generally avoid humans. Wolves can, however, lose their fear of humans and may approach camping areas or homes.

Attacks by healthy wild wolves do occur but are rare. The majority of attacks have been from rabid wolves.

Preventative actions include:

- Never feed wolves or any other wildlife.
- Dispose of all garbage.
- Ignore them as much as possible if they come into sight.
- Never allow a wolf to get close.
- Never approach a wolf.

According to the International Wolf Centre, if a wolf acts aggressively (growls or snarls) or fearlessly, actions that should be taken include:

- raising and waving arms to appear larger;
- backing away slowly with back turned;
- making noise; and
- throwing objects.



There has never been a documented case of a healthy, wild wolf killing a person in North America. Most wolves are not dangerous to humans. Injuries that have occurred by wolves have been caused by a few wolves that became fearless of humans due to habituation (wolves becoming too comfortable in human inhabited areas).

COYOTES

Unlike wolves, coyotes do not have a natural fear of human beings. In highly populated areas, they are often seen patrolling, looking for garbage or small animals. Coyotes that are being fed will often bite, sometimes seriously.

Preventative actions include:

- Never feed coyotes or any other wildlife.
- Dispose of all garbage.
- Supervise children closely.
- Keep pets inside at night.
- Never approach a coyote.

According to the Government of Manitoba – Manitoba Conservation, if a person encounters a coyote actions that should be taken include:

- stopping immediately and remaining calm;
- raising and waving arms to appear larger;
- backing away slowly if it is not looking in the direction; and
- throwing stones or other objects.



Never turn away from a coyote or run since this will encourage a coyote to chase. If a coyote ever attacks, fight back.

COUGARS

Cougar attacks are unlikely among humans, partially because cougars do not perceive humans as prey. Cougar populations are growing throughout western Canada. Females with kittens and those that are cornered, surprised or feeding on a kill may act aggressively. Cougars often show curiosity toward human activities without behaving aggressively.

Cougars may display various behaviours as a warning before an attack, such as stalking, crouching, sweeping their tail, extending their eye contact, snarling, keeping their body low to the ground, and pumping their rear legs.

Some preventative actions include:

- Do not hike alone.
- If confronted, stay calm and do not run; it may stimulate the instinct to chase.
- Maintain eye contact and shout as calmly as possible.
- Try to appear larger by raising and waving arms.
- Arm yourself with a stick.
- Never turn your back.
- Do not “play dead”.
- Throw rocks.

In Tawrell, P., *Camping and Wilderness Survival*, Leonard Paul Tawrell states if a cougar attacks, fight back aggressively using any object nearby such as sticks or rocks.

CONFIRMATION OF TEACHING POINT 2

QUESTIONS

- Q1. What are some preventive actions to take against a bear attack?
- Q2. What action should be taken if a wolf growls or snarls at you?
- Q3. What steps should be taken if you encounter a cougar?

ANTICIPATED ANSWERS

- A1. Some preventive actions include:
- making noise;
 - hiking in groups and in daylight;
 - staying on established trails;
 - using extra caution when travelling near rushing water or into the wind;
 - staying in open area as much as possible; and
 - disposing of garbage frequently, in designated areas.
- A2. If a wolf acts aggressively (growls or snarls) or fearlessly, the following actions should be taken, such as:
- raising and waving arms;
 - backing away slowly with back turned;
 - making noise; and
 - throwing objects.
- A3. Preventative actions for cougar encounters include:
- Do not hike alone.
 - If confronted, stay calm and do not run; it may stimulate the instinct to chase.
 - Maintain eye contact and shout as calmly as possible.
 - Try to appear larger.
 - Arm yourself with a stick.
 - Never turn your back.
 - Do not "play dead".
 - Throw rocks.

END OF LESSON CONFIRMATION

The cadets' participation in the activity in TP1 will serve as the confirmation of this lesson.

CONCLUSION

HOMEWORK/READING/PRACTICE

N/A.

METHOD OF EVALUATION

N/A.

CLOSING STATEMENT

Recognizing provincial/territorial wildlife is an important aspect of field training. Since cadets spend time training and hiking in the field, it is essential to recognize the wildlife that are present as well as to know how to coexist with them.

INSTRUCTOR NOTES/REMARKS

N/A.

REFERENCES

C0-111 (ISBN 978-0-9740820-2-8) Tawrell, P. (2006). *Camping and Wilderness: The Ultimate Outdoors Book* (2nd ed.). Lebanon, NH: Leonard Paul Tawrell.

C0-121 Canadian Wildlife Service and Canadian Wildlife Federation. (2007). *Hinterland Who's Who – Species*. Retrieved 26 February 2007, from <http://www.hww.ca/hww.asp?id=1&pid0>

C0-122 (ISBN 0-618-15313-6) Bowers, Nora, Bowers, Rick, and Kaufman, Kenn. (2004). *Kaufman Focus Guides: Mammals of North America*. New York, NY: Houghton Mifflin Company.

C2-043 The Hunting Outfitters. (2007). *The Hunting Outfitters*. Retrieved 9 February 2007, from <http://www.huntingoutfitters.com>.

C2-059 Parks Canada. (2007). *Bears and People: A Guide to Safety and Conservation on the Trail*. Retrieved 5 March 2007, from http://www.pc.gc.ca/pn-np/inc/PM-MP/visit/visit12a_e.pdf.

C2-060 International Wolf Center. (2003). *Wolves and Humans – Are Wolves Dangerous to Humans?* Retrieved 5 March 2007, from http://www.wolf.org/wolves/learn/basic/pdf/wh_are_wolves_dangerous.pdf.

C2-061 Waterton Park Information Services. (2007). *Reference Information Section*. Retrieved 5 March 2007, from <http://www.watertoninfo.com/r/pred.html>.

C2-062 International Wolf Center. (2002). *Living with Wolves: Tips for Avoiding Conflicts*. Retrieved 5 March 2007, from http://www.wolf.org/wolves/learn/basic/pdf/wh_avoiding%20conflict.pdf.

C2-064 Minnesota Trappers Association. (2007). *Canadian Lynx*. Retrieved 12 March 2007, from <http://www.mntrappers.com/lynx.html>.

C2-074 Manitoba Conservation. (2007). *Living with Wildlife in Manitoba*. Retrieved 25 April 2007, from http://www.gov.mb.ca/conservation/wildlife/problem_wildlife/pdf.coyote.html.

PROVINCIAL/TERRITORIAL WILDLIFE

		
<p>THE RED FOX</p>	<p>RED FOX LOCATIONS</p>	<p>RED FOX TRACKS</p>
<p><i>Bowers, N., Bowers, R., and Kaufman, K., Kaufman Focus Guides: Mammals of North America, Houghton Mifflin Company (p. 131)</i></p>	<p><i>Bowers, N., Bowers, R., and Kaufman, K., Kaufman Focus Guides: Mammals of North America, Houghton Mifflin Company (p. 130)</i></p>	<p><i>Canadian Wildlife Service & Canadian Wildlife Federation, 2003, Hinterland Who's Who - Mammal Fact Sheets. Retrieved 26 February 2007, from http://www.hww.ca/hww2p.asp?id=102&cid=0</i></p>
<p>The red fox is a small, dog-like mammal, with a sharp pointed face and ears. It has a lightly built body, a coat of lustrous long fur, and a large bushy tail. Generally, male foxes are bigger than females. Adult foxes weigh between 3.6 and 6.8 kg and are normally between 90 and 112 cm in length. Size varies between individuals and geographic locations—those in the north are normally bigger.</p>		
<p>The colour of the coat of a red fox is normally a variation of reddish brown, but can be silver, black, or even have a black cross on the back. The lower legs and feet of the red fox are usually blackish, and the tail has a white tip.</p>		
<p>Red foxes are Canada's most widespread mammal. They are found in all provinces and territories. Foxes are normally found in areas where there is a mix of open field and wooded or brushy country; however, they can also survive easily in a city.</p>		
<p>A fox is both a hunter and a scavenger. Their diet consists of rodents, rabbits, birds, insects, fruit, earthworms, reptiles, and carrion (dead flesh). Wolves, coyotes, and dogs will chase and sometimes kill foxes when the opportunity presents itself.</p>		
<p>Humans hunt foxes for their fur. Hunting and trapping are not authorized during the season when young are being raised. Hunting season occurs in early winter when the fur is good quality for trapping. Nuisance foxes are often destroyed on a local basis.</p>		
<p>Rabies is a contagious and fatal viral disease that is transferred through the saliva of the affected animal to a human. It causes madness and convulsions. Foxes have occasionally become a menace to public health, especially in rural areas, when epidemics of rabies sweep through wild mammal populations. Once symptoms are confirmed, rabid foxes should be avoided. When rabid, the normally shy foxes show no fear of people and are often seen in daylight. In advanced stages of the disease, they may foam at the mouth.</p>		

Figure A-1 The Red Fox

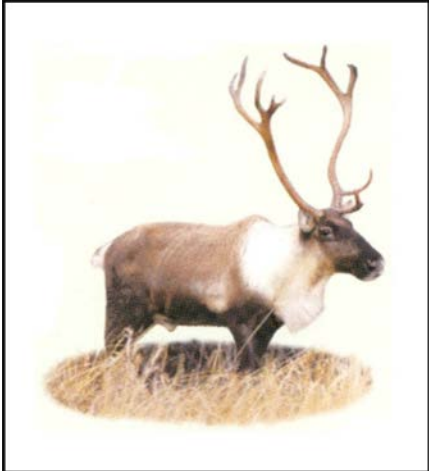


		 <p>ABOUT 10 cm</p>
THE CARIBOU	CARIBOU LOCATIONS	CARIBOU TRACK
<i>Bowers, N., Bowers, R., and Kaufman, K., Kaufman Focus Guides: Mammals of North America, Houghton Mifflin Company (p. 159)</i>	<i>Bowers, N., Bowers, R., and Kaufman, K., Kaufman Focus Guides: Mammals of North America, Houghton Mifflin Company (p. 158)</i>	<i>Bowers, N., Bowers, R., and Kaufman, K., Kaufman Focus Guides: Mammals of North America, Houghton Mifflin Company (p. 158)</i>
<p>The caribou is a member of the deer family. They are very tough and able to survive year-round in harsh climates. Their short, stocky bodies conserve heat, their long legs help them move through snow, and their long dense winter coats provide effective insulation, even during periods of low temperature and high wind.</p> <p>Caribou normally have dark faces and noses, light cream-coloured necks, and blackish legs. Size and colour will vary with location. The Southern Woodland Caribou is the largest and darkest; Peary's Caribou of the high Arctic islands is the smallest and palest. Colour will also vary with season. Caribou will be dark and brown in summer, and pale and grey in the winter. Unlike other deer, both males and females have antlers. Their antlers shed annually. Bulls (males) lose theirs shortly after the fall and cows (females) keep theirs until calving in the spring. Female antlers have a fuzzy covering, called velvet, which contains blood vessels that carry nutrients for growth.</p> <p>Caribou dwell in a variety of places such as forests, mountains, and tundra. In summer, caribou feed on a wide variety of plant material, including grasses, shrubs, sedges, twigs, and mushrooms. In winter, they feed mainly on lichens.</p> <p>When the caribou is in danger, it rears up on its hind legs and deposits a scent that alerts other caribou to the threat.</p> <p>It is believed that the caribou's name was derived from the Mi'kmaq word "xalibu" which means "the one who paws", mainly because they have very versatile hooves. In the winter, their hooves grow to an incredible length, giving them firm footing on crusty snow. In the summer, their hooves are worn away by travel over hard ground and rocks. They function as efficient scoops in the snow when trying to uncover lichens. Caribou are also excellent swimmers and their hooves function well as paddles.</p> <p>There are four subspecies of caribou in Canada: woodland, Peary, barren-ground west of the Mackenzie River (also known as Grant's caribou), and barren-ground east of the Mackenzie River. The Mackenzie River is located in the Northwest Territories, and it flows into the Arctic Ocean.</p>		

Figure A-2 The Caribou

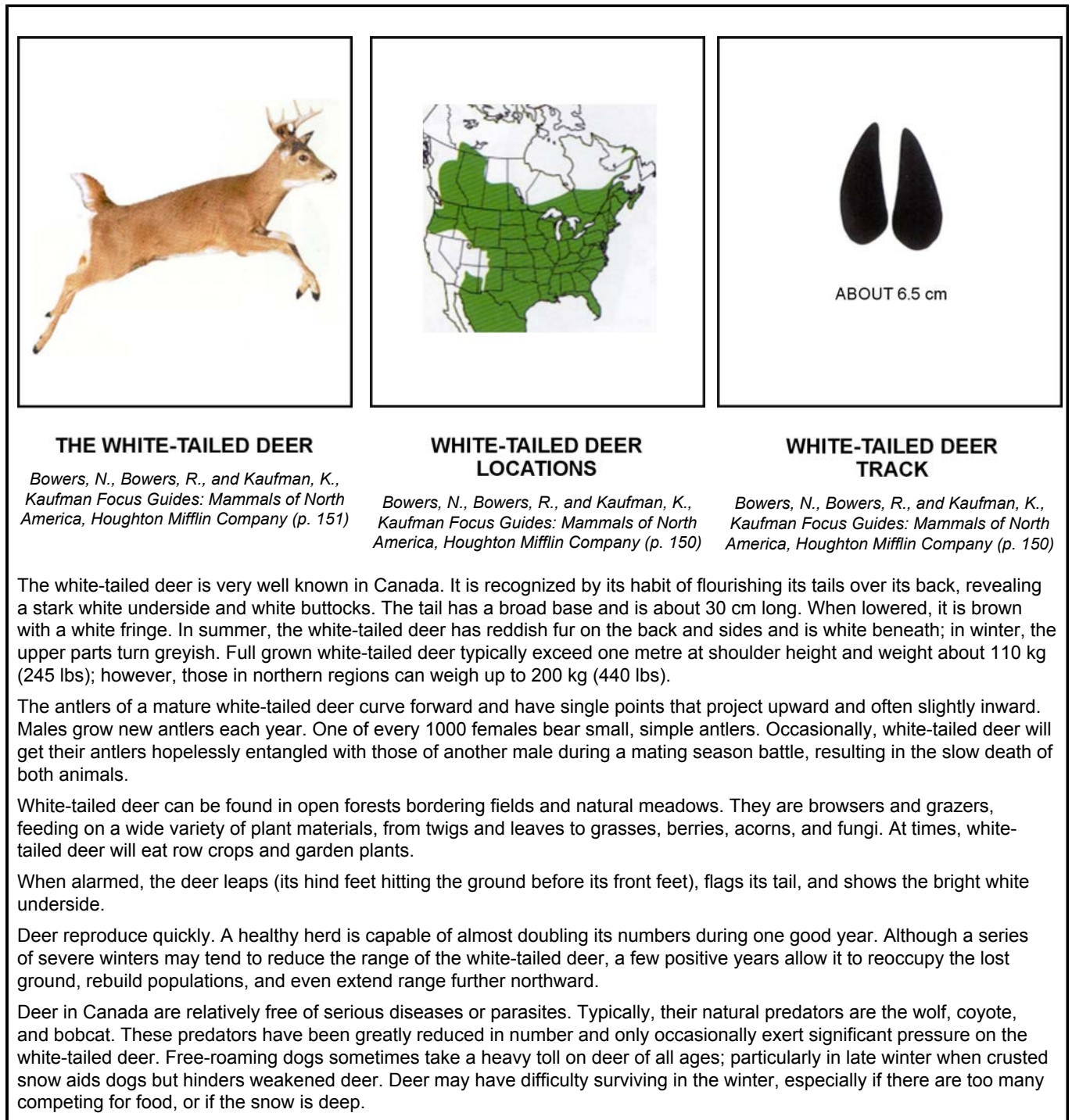


Figure A-3 The White-tailed Deer

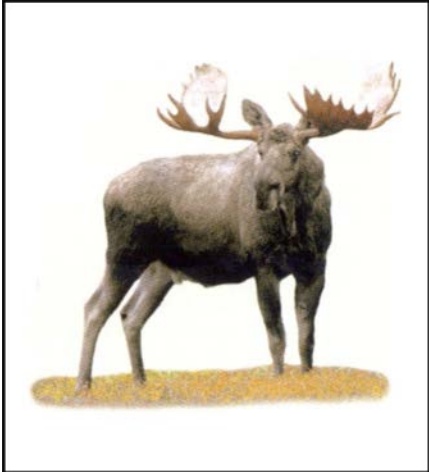

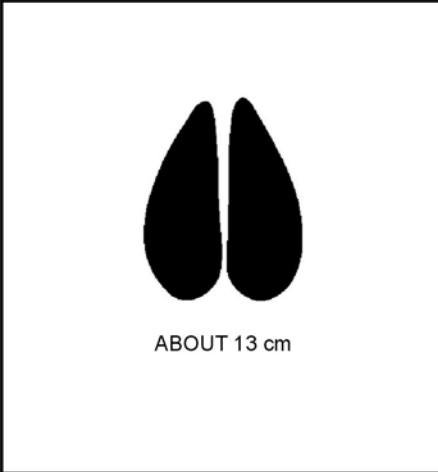
		 <p>ABOUT 13 cm</p>
<p>THE MOOSE</p>	<p>MOOSE LOCATIONS</p>	<p>MOOSE TRACK</p>
<p><i>Bowers, N., Bowers, R., and Kaufman, K., Kaufman Focus Guides: Mammals of North America, Houghton Mifflin Company (p. 155)</i></p>	<p><i>Bowers, N., Bowers, R., and Kaufman, K., Kaufman Focus Guides: Mammals of North America, Houghton Mifflin Company (p. 154)</i></p>	<p><i>Bowers, N., Bowers, R., and Kaufman, K., Kaufman Focus Guides: Mammals of North America, Houghton Mifflin Company (p. 154)</i></p>
<p>Moose have long, slim legs. Their bodies have massive muscles at the shoulders, giving them a humped appearance. The head is heavy and compact, and the nose extends in a long, mournful-looking arch. Most moose have a pendant of fur-covered skin that hangs about 30 cm long from the throat, commonly referred to as a bell. Their colour varies from dark brown, almost black, to reddish or greyish brown, with grey or white legs. Big bulls (males) weigh up to 600 kg (1320 lbs) in most of Canada; however, the subspecies found in the Yukon territory can weigh as much as 800 kg (1760 lbs). Moose have a great appetite and will consume up to 20 kg (45 lbs) of food per day. Their preferred food includes aquatic plants in the summer, twigs and woody stems in the winter, willow, and aspen leaves. The eyesight of the moose is extremely poor; however, they have great senses of smell and hearing.</p> <p>Like other members of the deer family, moose normally shed their antlers. Most moose will lose them in November, but some younger bulls may carry them until April. Their antlers can span up to 150 cm. Moose antlers have a broad flattening throughout and are pale, sometimes white.</p> <p>Moose can tolerate cold weather well, but suffer in the heat because they cannot perspire. During summer, moose can be found in marshy and watered areas, trying to cool off. Moose are excellent divers and swimmers, as are their young.</p> <p>Despite their huge size, adult moose are sometimes taken by predators such as wolves, black bears, and grizzly bears. Wolves and bears try to catch calves, but the mother moose can often successfully defend by striking out powerfully with her hooves. People should always avoid females with calves.</p> <p>Ticks are common on moose, especially in late winter. Moose are significantly weakened because the ticks suck blood which causes them to rub off their hair, and hence causes heat loss. When food is lacking, moose may develop a parasitic tapeworm called hydatid.</p> <p>Moose have adapted well to human activities and are an important economic resource in Canada. Moose hunting generates over \$500 million annually in economic activity. With continued management, they should always be part of Canadian culture.</p>		

Figure A-4 The Moose

		 <p>ABOUT 4 cm</p>
<p>THE SKUNK</p>	<p>SKUNK LOCATIONS</p>	<p>SKUNK TRACK</p>
<p><i>Bowers, N., Bowers, R., and Kaufman, K., Kaufman Focus Guides: Mammals of North America, Houghton Mifflin Company (p. 105)</i></p>	<p><i>Bowers, N., Bowers, R., and Kaufman, K., Kaufman Focus Guides: Mammals of North America, Houghton Mifflin Company (p. 104)</i></p>	<p><i>Bowers, N., Bowers, R., and Kaufman, K., Kaufman Focus Guides: Mammals of North America, Houghton Mifflin Company (p. 104)</i></p>
<p>The striped skunk is about the size of a cat. It has a stout body, a small head, short legs, and a bushy tail. The thick, glossy fur is black, with a thin white stripe down the centre of its face and a broad white stripe beginning on the back of the head. The tail is mostly black, and the stripes may extend down it, usually to a clump of white at the tip.</p> <p>The striped skunk has long, straight claws for digging out burrows of mice, ripping apart old logs for grubs and larvae, and digging in the sand for turtle eggs. It moves slowly and relies on its scent glands for safety.</p> <p>The striped skunk is a useful small mammal that inhabits farmlands, grasslands, and forests. They generally live in the abandoned dens of woodchucks, foxes, or other mammals of similar or larger size and will occasionally make their own dens. Skunks can also be found in stumps, rock piles, or refuse heaps. If a skunk digs its own den, it will be simple. A skunk will gather leaves by placing them under its body and then shuffle along to the den with the leaves between its legs as it moves. They are normally seen late afternoon and through the night.</p> <p>A striped skunk diet consists of insects, mice, shrews, ground squirrels, young rabbits, birds' eggs, and a variety of plants. They are an important predator on insect pests. It is preyed upon by bobcats and large birds. Motorists are also a great hazard to the skunk. Like porcupines, they are overly confident of their defence mechanism and often pay heavily for their manners when crossing highways.</p> <p>Skunks belong to the weasel family, all of whose members have well-developed scent glands and a musky odour. The striped skunk will spray a bad smelling fluid to defend itself. This spray can travel as far as six metres, and the smell is strong enough to be carried almost one kilometre in the wind. The scent is produced by a thick, yellow, oily fluid, secreted by two glands located on each side of the anus. The glands are about the size of a grape and contain about a tablespoon of musk. They are connected by tubes to two small nipples that are hidden when the tail is down, and exposed when the tail is raised. The musk is normally discharged as a last measure after repeated warning signs. They will usually try to retreat from a human or large enemy. An angry skunk will growl or hiss, and stamp its front feet rapidly. They may even walk a short distance on its front feet with its tail high in the air. The striped skunk cannot spray from this position. To perform this defence, the skunk usually humps its back and turns in a U-shaped position so that both the head and the tail face the enemy.</p>		

Figure A-5 The Striped Skunk






		
THE RACCOON	RACCOON LOCATIONS	RACCOON TRACKS
<i>Bowers, N., Bowers, R., and Kaufman, K., Kaufman Focus Guides: Mammals of North America, Houghton Mifflin Company (p. 99)</i>	<i>Bowers, N., Bowers, R., and Kaufman, K., Kaufman Focus Guides: Mammals of North America, Houghton Mifflin Company (p. 98)</i>	<i>Bowers, N., Bowers, R., and Kaufman, K., Kaufman Focus Guides: Mammals of North America, Houghton Mifflin Company (p. 98)</i>
<p>Raccoons are well-known for their mischievous-looking black face mask. They are normally greyish in colour with a tail marked by five to ten alternating black and brown rings. Body colouration varies from albino (white), to black or brown. Raccoons begin to shed their fur in the spring, which lasts for about three months. Their head is broad, with a pointed snout. Their short rounded ears measure about four to six centimetres. Raccoons have black eyes. The body and tail length for adults averages about 80 cm; males are generally larger than females. Size varies with climate.</p> <p>Raccoons are able to live in a wide range of habitats. They can be found in hardwood swamps, forests, marshes, farmlands, and even in cities. They always favour the vicinity of water and trees and are plentiful in wooded swamps.</p> <p>Raccoons will consume practically any food item, plant or animal. They like corn, crayfish, nuts, and fruits, but there is a seasonal shift in diet depending on availability of food items. They are a familiar “masked bandit”, and have been long known to raid garbage cans and garden plots at night.</p> <p>The name raccoon is derived from the Algonquian word arakun, meaning “he scratches with his hand”. They use their front feet like hands to manipulate food items and are famed for appearing to “wash” their food before eating it.</p> <p>Since the raccoon can be easily tamed when young, many people have had their lives enriched by a close association with this intelligent, inquisitive animal. Males, however, may become aggressive as they mature and usually end up being returned to the wild. The raccoon is one of the few creatures that are capable of making the adjustment from family pet back to wild animal.</p>		

Figure A-6 The Raccoon

		 <p>FRONT ABOUT 11.5 cm</p> <p>HIND ABOUT 9.5 cm</p>
<p>THE GRAY WOLF</p>	<p>GRAY WOLF LOCATIONS</p>	<p>GRAY WOLF TRACKS</p>
<p><i>Bowers, N., Bowers, R., and Kaufman, K., Kaufman Focus Guides: Mammals of North America, Houghton Mifflin Company (p. 127)</i></p>	<p><i>Bowers, N., Bowers, R., and Kaufman, K., Kaufman Focus Guides: Mammals of North America, Houghton Mifflin Company (p. 126)</i></p>	<p><i>Bowers, N., Bowers, R., and Kaufman, K., Kaufman Focus Guides: Mammals of North America, Houghton Mifflin Company (p. 126)</i></p>

Wolves, also known as gray wolves, vary in colour. They are often grey-brown, but can also be black, white, or reddish. They have long bushy tails. Their colour variation is a good example of natural selection; since those found in the north are normally white and those found in forests will normally have greyish, greenish, and brownish coats. Wolves look a lot like a German Sheppard, but they have a narrower chest, longer legs, and bigger feet. When running, wolves carry their tails straight out behind them.

Wolves have a highly organized social structure that centres on a dominant male and a dominant female. A dominant wolf will hold its tail high and stand stiff-legged. They are very territorial.

Gray wolves live in packs of five to ten which normally consist of a breeding pair, their young from recent years, and sometimes unrelated wolves. All pack members cooperate in hunting and sharing kills. They travel great distances over home ranges. When hunting, they can put on bursts of speed up to 70 kilometres per hour. In addition to preying on hoofed animals such as moose or bison, they take hares, beavers, and many smaller creatures. Wolves communicate, and maintain distance from other packs, by howling.

The main prey of wolves are large mammals such as deer, moose, caribou, and elk. Wolves also eat a variety of smaller mammals and birds, but these rarely make up more than a small part of their diet. Wolves work hard for their food. Studies show that they kill only about one large mammal for every 10 chased. In winter, they usually kill old and young animals. When prey numbers decline, the entire pack of wolves will prey on all age groups. In summer, much of the wolves' diet consists of young animals born that year, because they are the easiest to catch.

The wolf was once a much criticized animal. In popular children's tales like *Little Red Riding Hood* and *The Boy Who Cried Wolf*, the wolf is made out to be a raider and a killer of livestock and people. There are no records of wolves killing humans in Canada or the United States. Today, many people know that scientists studying wolves have lived very close to dens where there were pups without being attacked. In areas where wolves are hunted or trapped, they fear people and are very wary. However, in remote places, such as the Canadian Arctic, they show little fear and will often allow people to live near them.

Figure A-7 The Gray Wolf

		
THE CANADIAN LYNX	CANADIAN LYNX LOCATIONS	CANADIAN LYNX TRACKS
<i>Bowers, N., Bowers, R., and Kaufman, K., Kaufman Focus Guides: Mammals of North America, Houghton Mifflin Company (p. 139)</i>	<i>Bowers, N., Bowers, R., and Kaufman, K., Kaufman Focus Guides: Mammals of North America, Houghton Mifflin Company (p. 138)</i>	<i>Minnesota Trappers Association, Mike Stutz, 2007, Minnesota Trappers Association - Canadian Lynx. Retrieved 12 March 2007, from http://www.mntrappers.com/lynx.html</i>
<p>The Canadian lynx resembles a very large domestic cat. It has a short tail, long legs, large feet, and prominent ear tufts. Its winter coat is light grey and slightly speckled with long guard hairs; the under fur is brownish, and the ear tufts and the tip of the tail are black. The summer coat is much shorter than the winter coat and has a reddish brown cast.</p> <p>Its large feet, which are covered during the winter by a dense growth of coarse hair, help the lynx travel over snow. The Canadian lynx can spread its toes in soft snow, expanding its "snowshoes". The lynx has large eyes and ears and relies on its acute sight and hearing when hunting. The lynx's claws, like those of most other cats, are retractable and used primarily for catching prey and fighting.</p> <p>The lynx makes a variety of sounds, like those made by house cats, but louder.</p> <p>The Canadian lynx generally lives in forested wilderness areas. It prefers old growth boreal forests with dense undercover of wood and windfalls. However, it will populate other types of habitat as long as they contain some forest cover and adequate numbers of prey, in particular snowshoe hares.</p> <p>As long as they are not disturbed, lynx are remarkably tolerant of human settlement. Like the cougar and bobcat, the Canadian lynx tends to be secretive, active at night and rarely seen.</p> <p>The lynx preys almost exclusively on the snowshoe hare. Since snowshoe hare populations follow a 10 year cycle, lynx numbers dramatically vary, building to a peak as hare populations increase, and then crashing. Their supplement diet consists of grouse, voles, mice, squirrels, and foxes. They may also supplement their diet with carrion or dead flesh from big game such as deer.</p> <p>The Canadian lynx normally hunts alone and during the night. A lynx can jump as far as 6.5 m, which equals about four hops for a hare.</p>		

Figure A-8 The Canadian Lynx



Figure A-9 The Black Bear

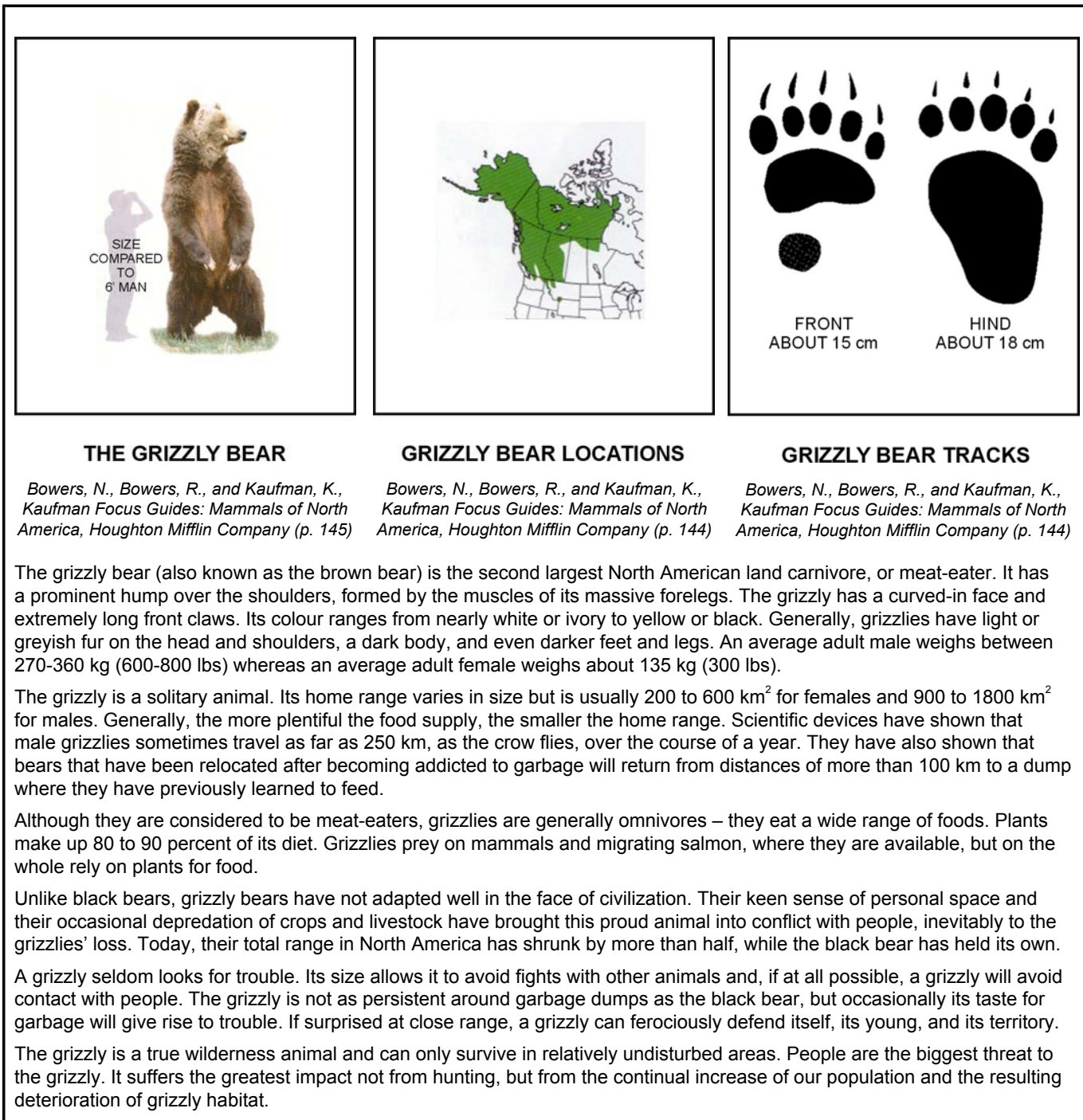


Figure A-10 The Grizzly Bear

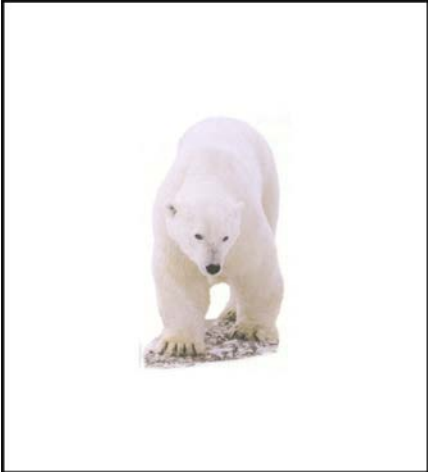


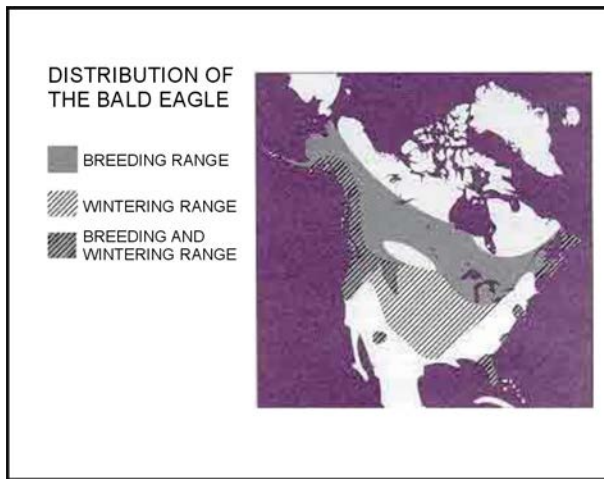
		 <p>FRONT ABOUT 12 cm</p> <p>HIND ABOUT 20 cm</p>
<p>THE POLAR BEAR</p> <p><i>Bowers, N., Bowers, R., and Kaufman, K., Kaufman Focus Guides: Mammals of North America, Houghton Mifflin Company (p. 147)</i></p>	<p>POLAR BEAR LOCATIONS</p> <p><i>Bowers, N., Bowers, R., and Kaufman, K., Kaufman Focus Guides: Mammals of North America, Houghton Mifflin Company (p. 146)</i></p>	<p>POLAR BEAR TRACKS</p> <p><i>National Wildlife Federation, 2005, eNature - Polar Bear. Retrieved 22 March 2007, from http://www.enature.com/fieldguides/detail.asp?shapeID=1026&curGroupID=5&lgfromWhere=&curPageNum=4&viewType=tracks</i></p>
<p>The polar bear is the largest land carnivore, or meat eater. The white coat of a polar bear will often appear cream or yellow against arctic ice. Adult males measure from 240 to 260 cm in total length and usually weigh from 400 to 600 kg (880 to 1320 lbs); however, they can weigh as much as 800 kg (1760 lbs) – about the weight of a small car. Adult females are about half the size of males. The polar bear has a long body, neck, and skull. They have large canine teeth and the grinding surfaces of their cheek teeth are jagged, which is an adaptation of a carnivorous diet. Polar bear claws are brownish in colour, short, fairly straight, sharply pointed, and non-retractable.</p> <p>Polar bears prefer areas of ice, which they use for a hunting platform and protective cover, combined with snow drifts, refrozen cracks, and areas of open water surrounded by ice. This habitat preference is closely linked to the presence of their favourite food, ringed seals. They are superbly adapted to their arctic surroundings. Their thick winter coats, with glossy guard hairs and dense under fur, and the thick layer of fat beneath the skin protect them against the cold. Guard hairs shed water easily, so after a swim the polar bear can shake itself off like a dog to decrease chilling and speed the drying process. The white colour of the polar bear also serves as camouflage.</p> <p>The bears' normal pace is a slow, lumbering walk of about 5 to 6 km per hour. They may gallop when chased, but they do not run for long periods of time. When hunting, polar bears rely mainly on their sense of smell. They can detect seal breathing holes covered by layers of ice and snow 90 cm or more thick and up to a kilometre away. Polar bears are excellent swimmers, using their large front paws as powerful oars, while their rear paws trail behind and act like rudders. Underwater, they keep their eyes open. A polar bear may remain below the surface for over a minute.</p> <p>Polar bears will usually not attack humans except to protect their cubs or because they are starving.</p> <p>Although polar bears are not in immediate danger of extinction, they face threats common to all large predators: human violation on their habitat, illegal hunting, and chemical contaminants in their prey. A new threat appears to be global warming or climate change, which is affecting the polar bear's habitat by reducing the total ice cover in the Arctic, thinning the permanent pack of ice of the central polar basin, and changing the timing of freeze-up and break-up in more southerly areas, such as Hudson Bay.</p> <p>The polar bear has been designated as a species of special concern in Canada because of characteristics that make it particularly sensitive to human activities and natural events.</p>		

Figure A-11 The Polar Bear



THE BALD EAGLE

Canadian Wildlife Service & Canadian Wildlife Federation, 2003, Hinterland Who's Who - Bird Fact Sheets. Retrieved 26 February 2007, from <http://www.hww.ca/hww2p.asp?id=27&cid=0>



BALD EAGLE LOCATIONS

Canadian Wildlife Service & Canadian Wildlife Federation, 2003, Hinterland Who's Who - Bird Fact Sheets. Retrieved 26 February 2007, from <http://www.hww.ca/hww2p.asp?id=27&cid=0>

The bald eagle is Canada's largest bird of prey. One of 59 species of eagles in the world, the bald eagle is one of two eagles in North America (the other is the Golden Eagle). It is the only eagle found exclusively in North America.

Bald eagles are enormous birds. They have a wing span of about two metres. When perched, a fully grown bald eagle measures about 76 cm tall. It is not uncommon for a bald eagle to weigh over seven kilograms. On average, females are larger than males and juveniles are larger but lighter in weight than adults of the same sex. Adults have a dark brown (almost black) body that contrasts sharply with the white feathers on the head and tail, and the yellow beak, eyes, and legs. It takes a young bald eagle four or five years to achieve this distinct colouration.




Bald eagles can see three or four times farther than most people, which is a huge advantage to a bird that hunts and scavenges. They have a sufficient sense of hearing but their senses of taste and smell are poorly developed.

Bald eagles feed primarily on fish, aquatic birds, and mammals, which they may take alive or find dead. The majority of live food consumed consists of the sick or those wounded by hunters. To kill and handle prey, bald eagles have massive beaks, large talons, and oversized feet equipped with small spikes, called spicules. They take food any way they can, stealing from other birds, scavenging on dead flesh, and hunting in flight, from a perch, on the ground, or in shallow water. They will sometimes feed in groups, but rarely cooperate when hunting. Generally, adults are likely to hunt and kill, whereas younger birds rely on scavenging and stealing.

Canadian bald eagle populations are currently relatively stable, although the situation varies regionally. Currently, populations in coastal British Columbia, the boreal forest, and the Atlantic provinces are doing well. Local populations in southern Ontario and New Brunswick, as well as the lower 48 states of the United States, are endangered.

If mortality rates continue to be high, population growth will be slow. However, if suitable habitats remain available and human disturbance is kept to a minimum, the magnificent soaring bird will be enjoyed for many years to come.

Figure A-12 The Bald Eagle

		 <p>ABOUT 9 cm</p>
<p>THE COUGAR</p> <p><i>Bowers, N., Bowers, R., and Kaufman, K., Kaufman Focus Guides: Mammals of North America, Houghton Mifflin Company (p. 137)</i></p>	<p>COUGAR LOCATIONS</p> <p><i>Bowers, N., Bowers, R., and Kaufman, K., Kaufman Focus Guides: Mammals of North America, Houghton Mifflin Company (p. 136)</i></p>	<p>COUGAR TRACK</p> <p><i>Bowers, N., Bowers, R., and Kaufman, K., Kaufman Focus Guides: Mammals of North America, Houghton Mifflin Company (p. 136)</i></p>

In Canada, cougar, mountain lion, puma, and panther are all the same species. Like all cats, the cougar has a muscular, deep-chested body, with a round and short head. Its whiskers are well developed and its eyes are large. The most distinctive feature of the cougar is its long tail, which is useful for balance.




Cougars vary considerably in size and weight throughout their range. Adult cougars weigh about 1.4 times more than females. An average weight for a male cougar is about 70 kg (155 lbs); and about 40 kg (88 lbs) for a female. Colours range from reddish orange or orange grey to dark chocolate brown. Cougars have black on the tips of their ears and tails, and black markings on their faces. A kitten cougar will be spotted at birth, but the spots will disappear before their first birthday. Cougars have very strong necks and muscular jaws with long canine teeth.

Cougars live in a wide range of vegetation. Cover, in the form of vegetation and irregular landscape is important to cougars. Even where their home ranges overlap, cougars avoid each other. Adults of both sexes travel alone, except when mating or when females are accompanied by their kittens. Because cougars reside at the top of the food chain, healthy cougar populations are good indicators of healthy and balanced ecosystems.

Like all cats, cougars hunt more by sight and hearing than by scent. They stalk their prey to within two or three great leaps and then launch a lightening-fast charge that ends with the cougar striking the prey with full impact of the charge and bearing it to the ground. Cougars hunt deer, elk, and moose calves. They will also hunt small mammals such as porcupines, beavers, coyotes, snowshoe hares, ground squirrels, and birds. Cougars typically kill their own food. Scavenging or eating dead animals is rare.

In places where cougar hunting is allowed, it is the most common cause of death. Since cougars frequently kill prey larger than themselves, they are continually exposed to the risk of serious injuries, which eventually take their toll. The cougar has virtually disappeared in the east. Fortunately, sufficient wilderness remained in the west and enabled the cougar to survive.

Figure A-13 The Cougar

		 <p>FRONT ABOUT 7 cm LONG 7.6 cm WIDE</p> <p>HIND ABOUT 17 cm LONG 13 cm WIDE</p>
THE BEAVER	BEAVER LOCATIONS	BEAVER TRACKS
<p><i>Canadian Wildlife Service & Canadian Wildlife Federation, 2003, Hinterland Who's Who - Mammal Fact Sheets. Retrieved 25 April 2007, from http://www.hww.ca/hww2p.asp?id=102&cid=0</i></p>	<p><i>Canadian Wildlife Service & Canadian Wildlife Federation, 2003, Hinterland Who's Who - Mammal Fact Sheets. Retrieved 25 April 2007, from http://www.hww.ca/hww2p.asp?id=102&cid=0</i></p>	<p><i>Canadian Wildlife Service & Canadian Wildlife Federation, 2003, Hinterland Who's Who - Mammal Fact Sheets. Retrieved 25 April 2007, from http://www.hww.ca/hww2p.asp?id=102&cid=0</i></p>

The beaver is the largest rodent in North America. An adult beaver has a tail that is approximately 30 cm long, will weigh 16 to 32 kg (35 to 70 lbs) and can measure up to 1.3 m long. The beaver is normally brown and very round and compact. It is very slow on land but an excellent swimmer. It can swim about 7 km per hour if it is alarmed. The beaver has very large hind feet, which help it swim. It can use its paws to carry sticks, stones and mud. Their paws are also a great help in construction.

The beaver is commonly found in forested areas where water is present or nearby. It spends the majority of its life logging. One beaver will cut down an average of 216 trees a year. It can cut a tree 40 cm in diameter! A single beaver will usually cut one tree, but sometimes two will work on a large one. In the winter, the beaver's main diet is sticks. It will shift from a wood to a herbivore diet when spring arrives and new growth appears. In the summer, the beaver will eat grasses, herbs, leaves of woody plants, fruits and aquatic plants.

The beaver is a superb builder. Its best-known structure, the dam, is only built by beavers that need to enlarge their underwater habitat that will be open to them in the winter. The dam creates a deep pond that will not freeze to the bottom, which provides storage for winter food and year-round underwater access secure from predators.

The beaver's tail has important uses both in the water and on land. It may be 30 cm long, up to 18 cm wide and 4 cm thick. It is covered with leathery scales and coarse hairs and is very muscular. The beaver uses its tail as a rudder in the water. It also serves as a counterbalance and support when it is walking on its hind legs while carrying building materials like mud, stones, or branches with its front paws.


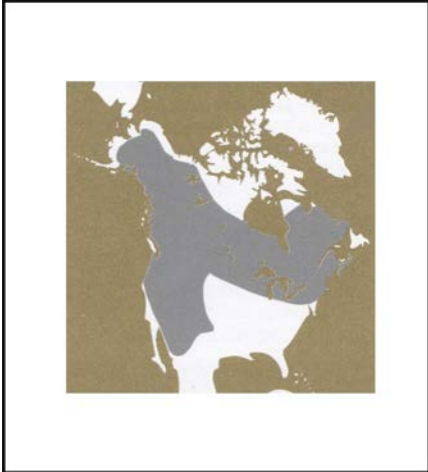
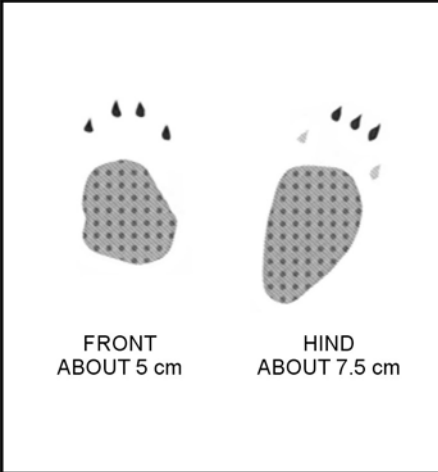
The beaver falls prey to wolves, coyotes, bears, lynx and wolverines when looking for food on the shore or travelling over land.

The beaver has had a great influence on Canada's history. Canadians now celebrate the beaver as a national symbol on stamps, coins and emblems. There are also hundreds of Canadian lakes, towns, rivers and hill ranges that bear the name of this great rodent.

Figure A-14 The Beaver



Figure A-15 The Coyote

		 <p>FRONT ABOUT 5 cm</p> <p>HIND ABOUT 7.5 cm</p>
<p>THE PORCUPINE</p> <p><i>Bowers, N., Bowers, R., and Kaufman, K., Kaufman Focus Guides: Mammals of North America, Houghton Mifflin Company (p. 108)</i></p>	<p>PORCUPINE LOCATIONS</p> <p><i>Canadian Wildlife Service & Canadian Wildlife Federation, 2003, Hinterland Who's Who - Mammal Fact Sheets. Retrieved 25 April 2007, from http://www.hww.ca/hww2p.asp?id=102&cid=0</i></p>	<p>PORCUPINE TRACKS</p> <p><i>Bowers, N., Bowers, R., and Kaufman, K., Kaufman Focus Guides: Mammals of North America, Houghton Mifflin Company (p. 108)</i></p>

The porcupine has a short, blunt-nosed face with small eyes. Its ears are small and round, almost concealed by its hair. The porcupine has humped shoulders and short legs. It is Canada's second largest rodent, next to the beaver. Adult males reach an average weight of 12 lbs (5.5 kg) after six years, whereas females will reach about 10 lbs (4.5 kg). The total length averages 68–100 cm and the height at the shoulders is about 30 cm. The porcupine has a coat comprised of a soft, brown, woolly undercoat and coarse, long guard hairs. At the base, each guard hair is brown, and becomes darker near the tip. The tip may be different colours in different places—white in eastern areas and yellow in western areas.

The porcupine can be found in most areas and spends the majority of winter in a den. The porcupine feeds largely on the inner bark of trees in winter as well as a variety of plants. One of the best-known and least-liked eating habits is that of chewing wood and leather in and around camps. When human-made objects are not available, the porcupine will chew bones and cast-off antlers.

On the porcupine's face the quills are about 1.2 cm long; on the back they can be up to 12.5 cm in length. There are no quills on the muzzle, legs, or under parts of the body. These quills are hollow and are embedded in the skin. When alarmed, a small muscle that is attached to each quill pulls it upright in the fur. About 0.6 cm from the tip, the quill tapers to a fine point that is covered by several dozen small black barbs. These barbs feel slightly rough to the touch, but when they are moist (as they get when embedded in the flesh), they swell and work the quill further in. The porcupine has been estimated to have over 30 000 quills. When quills are lost, they are replaced by new quills, which are white and sharp and remain firmly anchored in the skin until they are fully grown. When in danger, the porcupine will first try to escape. When escape is not an option, the porcupine will hump its back and tuck its head between the shoulders. With all quills erect, it will pivot on its front feet, keeping its back to the enemy. As the back feet stomp around, the tail will be lashed around. The momentum of the tail detaches the loose quills, which fly through the air giving the impression that they were thrown.

Porcupine quills have been found embedded in several predators including the coyote, cougar, bobcat, red fox, lynx, bear and wolf. Some more experienced predators learn to avoid the quills and kill the porcupine by biting its head or by flipping it and exposing its unprotected belly. Being short-sighted and a slow mover, the porcupine is a frequent victim in forest fires and on roadways.

Figure A-16 The Porcupine

PROVINCIAL/TERRITORIAL

WILDLIFE WORKSHEET

NAME OF WILDLIFE:

GENERAL DESCRIPTION:

HABITAT:

DIET:

UNIQUE CHARACTERISTICS:

THIS PAGE INTENTIONALLY LEFT BLANK



ROYAL CANADIAN ARMY CADETS

RED STAR

INSTRUCTIONAL GUIDE



SECTION 4

EO M221.04 – PERFORM BASIC FIRST AID

Total Time:

30 min

PREPARATION

PRE-LESSON INSTRUCTIONS

Resources needed for the delivery of this lesson are listed in the lesson specification located in A-CR-CCP-702/PG-001, Chapter 4. Specific uses for said resources are identified throughout the Instructional Guide within the TP for which they are required.

Review the lesson content and become familiar with the material prior to delivering the lesson.

PRE-LESSON ASSIGNMENT

N/A.

APPROACH

A demonstration was chosen for TP1 and TP2 as it allows the instructor to explain and demonstrate the skills the cadet is expected to acquire.

A performance was chosen for TP3 as it provides an opportunity for the cadets to practice basic first aid under supervision.

INTRODUCTION

REVIEW

N/A.

OBJECTIVES

By the end of this lesson the cadet shall be expected to perform basic first aid for minor wounds and first-degree burns.

IMPORTANCE

It is important for cadets to be able to treat minor wounds and first-degree burns in a field setting. Basic first aid training gives cadets basic knowledge and skills which, if applied correctly, may prevent further injuries and discomfort to the injured.



Knowing what to do during a first aid situation is important. However, cadets shall seek a qualified first-aider whenever an injury occurs.

Teaching Point 1

Identify and Treat Minor Wounds

Time: 5 min

Method: Demonstration

MINOR WOUNDS

Minor wounds are those that do not have severe bleeding. Bleeding wounds can be internal (inside the body) or external (outside the body). Some common external bleeding wounds are:

- abrasions and scrapes; and
- cuts.

Almost any external bleeding wound can be serious. There is always a risk of infection when the skin's top layer is broken. Knowing how to identify and treat minor wounds is essential to reduce the risk of infection or aggravation.

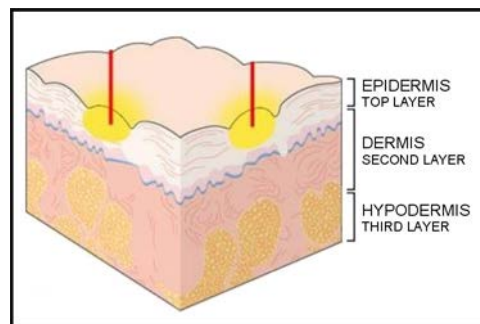


Figure 1 Layers of Skin

Irishhealth.com, Copyright 2007 by Irishhealth.com. Retrieved 17 March 2007, from <http://irishhealth.com/indez.html?level=4&con=467>

Abrasions and Scrapes

Abrasions are located on the top layer of the skin. They occur when the skin is scraped or rubbed away and are often painful. The skin may bleed small amounts of blood.

Cuts

Cuts are breaks in the top or second layer of the skin. There is often some minor bleeding involved.



Figure 2 Leg Scrape

TheFatManWalking.com, Copyright 2006 by The FatManWalking.com. Retrieved 6 March 2007, from <http://www.thefatmanwalking.com/page/65492/?jsessionid=mni5xlvdqm9>

TREATMENT OF MINOR WOUNDS

Emergency care for treating minor wounds has three basic objectives:

- to control bleeding;
- to prevent further injury; and
- to reduce the risk of infection.



A cadet should help with a demonstration on the principles of cleaning and treating a wound.

Follow the principles listed below when cleaning and treating a minor wound, to avoid infection.

1. Wash hands with soap and water and put gloves on, if available.
2. Do not cough or breathe directly over the wound.
3. Fully expose the wound, without touching it.
4. Gently wash loose material from the surface of the wound. Wash and dry the surrounding skin with clean dressings, cleaning the wound with clean gauze wiping from the centre of the wound to the edge of the wound. (An antibiotic cream can be used on surface wounds and abrasions).
5. Cover the wound promptly with a sterile dressing.
6. Tape the dressing in place.
7. Remove and dispose of the gloves and wash your hands and any other skin area that may have been in contact with the casualty's blood.



Figure 3 Washing the Wound

Medline Plus, Medical Encyclopedia, Copyright 2007 by US National Library of Medicine. Retrieved 19 March 2007, from http://www.nlm.nih.gov/medecineplus/ency/presentations/100208_4.htm



Figure 4 Dressing and Taping the Wound

Medline Plus, Medical Encyclopedia, Copyright 2007 by US National Library of Medicine. Retrieved 19 March 2007, from http://www.nlm.nih.gov/medecineplus/ency/presentations/100208_4.htm

CONFIRMATION OF TEACHING POINT 1

QUESTIONS

- Q1. Which layer of skin can be affected by a minor wound?
- Q2. What is the first thing to do before treating a minor wound?
- Q3. When washing the wound, what motion should be used?

ANTICIPATED ANSWERS

- A1. Epidermis or top layer can be affected by a minor wound .
- A2. Wash hands with soap and put on gloves.
- A3. Wipe away from the centre of the wound to the edge of the wound.

Teaching Point 2**Identify Types of Burns and Treat First-degree Burns**

Time: 10 min

Method: Demonstration

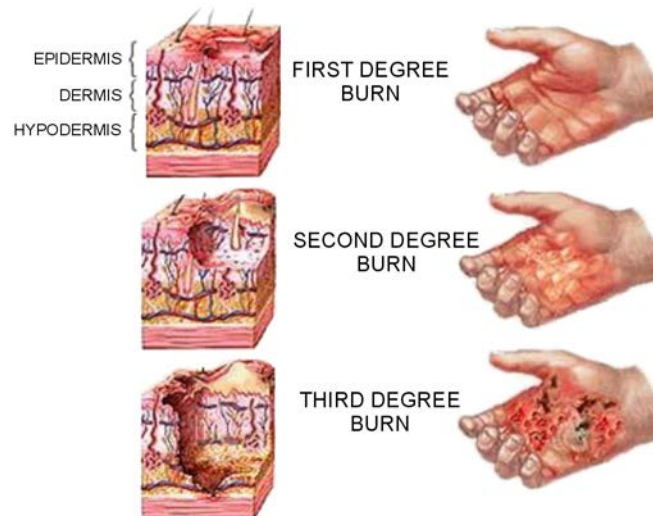
TYPE OF BURNS

Figure 5 Types of Burns

Medline Plus, Medical Encyclopedia, Copyright 2007 by US National Library of Medicine. Retrieved 19 March 2007, from http://www.nlm.nih.gov/medecineplus/ency/presentations/100208_4.htm



Ask cadets for the signs and symptoms of the various types of burns.

First-degree Burns

These are also called superficial burns and only affect the top layer of skin. Hot liquids, heat, and the sun are the main causes.

Signs and symptoms of a first-degree burn include:

- pinkish-reddish skin;
- slight swelling of the area;
- mild to moderate pain in the area; and
- sore, dry skin.



Figure 6 First-degree Burn

Trip Report-World Championship in Japan. Retrieved 17 March 2007, from http://homepages.paradise.net.nz/mischief/cp_japan_trip_report.html



Cadets who have been sunburned have had a first-degree burn.

Second-degree Burns

These affect the second layer of skin. Hot liquids, the sun, chemicals, and fire are the main causes.

Signs and symptoms of a second-degree burn include:

- raw-looking, moist skin;
- skin colouring that may range from white to cherry red;
- blisters containing clear fluid; and
- extreme pain in the area.



Figure 7 Second-degree Burn

Sickkids.ca. Copyright 1999 by The Hospital for Sick Children. Retrieved 6 March 2007, from <http://www.sickkids.ca/plasticsurgery/section.asp?s=Burns&slD=4489&ss=About+Burns&ssID=4496>

Third-degree Burns

These affect the third layer of skin and can extend into the muscle. Contact with extreme heat sources (e.g. hot liquids and solids, direct flame, chemicals) and electricity are the main causes.

Signs and symptoms of a third-degree burn include:

- dry, leathery skin;
- pearly white, tan, grey, or charred black skin;
- blood vessels or bone may be visible,
- little or no pain (nerves are destroyed);
- breathing problems; and
- shock.



Figure 8 Third-degree Burn

Sickkids.ca. Copyright 1999 by The Hospital for Sick Children. Retrieved 6 March 2007, from <http://www.sickkids.ca/plasticsurgery/section.asp?s=Burns&SID=4489&ss=About+Burns&ssID=4496>

TREATMENT OF FIRST-DEGREE BURNS



All burns should be brought immediately to a qualified first-aider.

A cadet should help with a demonstration on the principles of cleaning and treating a burn.

Heat Burns

These are the most common types of burns, and are caused by sources of heat such as flames from stoves, lanterns, and fires. A scald is a heat burn caused by hot liquid or steam.

To treat a heat burn:

1. Immerse the burn in cool water (if this is not possible, flush the burn with cool water and cover it with a clean, wet cloth).
2. Cool the burn until the pain is reduced.
3. Avoid the affected area.

4. When the pain has lessened, cover the burn with a clean, lint-free dressing.
5. Seek medical attention, if necessary.



Figure 9 Cooling the Burn

Medline Plus, Medical Encyclopedia, Copyright 2007 by US National Library of Medicine. Retrieved 19 March 2007, from http://www.nlm.nih.gov/medecineplus/ency/presentations/100213_1.htm



Figure 10 Dressing the Burn

Medline Plus, Medical Encyclopedia, Copyright 2007 by US National Library of Medicine. Retrieved 19 March 2007, from http://www.nlm.nih.gov/medecineplus/ency/presentations/100213_1.htm

Sunburns. These are also called radiation burns. Sunburns are caused by over-exposure to sunlight and can be prevented by wearing sunscreen of a high sun protection factor (SPF), long sleeves, and wide-brimmed hats. Sunburns range from mild to serious.



SPF indicates the time a person using sunscreen can be exposed to sunlight before getting a sunburn. For example, a person who would normally burn after 12 minutes in the sun would expect to burn after 120 minutes if protected by a sunscreen with SPF 10.

The higher the SPF, the more protection a sunscreen offers against ultraviolet radiation (UV).

To treat a minor sunburn:

- seek shade;
- gently sponge the area with cool water;
- cover the area with a cool wet towel;
- repeat as needed to relieve pain;

- pat the skin dry;
- apply medicated sunburn lotion (ointment); and
- seek medical attention, if necessary.



Blisters caused by sunburns should not be broken.

Fevers and vomiting indicate serious sunburn and medical attention should be sought immediately.

CONFIRMATION OF TEACHING POINT 2

QUESTIONS

- Q1. What is the most common first-degree burn a cadet can suffer?
- Q2. Name two signs or symptoms of a third-degree burn.
- Q3. What is the first thing to do in a case of heat burn?

ANTICIPATED ANSWERS

- A1. Sunburn.
- A2. Dry, leathery skin; pearly white, tan, grey, or charred black skin; blood vessels or bone may be visible; little or no pain (nerves are destroyed); breathing problems and shock.
- A3. Immerse the burn in cool water, flush the burn with cool water or apply a wet cloth. The burn should be cooled until the pain is reduced.

Teaching Point 3

Perform Basic First Aid

Time: 10 min

Method: Performance

ACTIVITY

OBJECTIVE

The objective of this activity is to allow cadets to practice performing basic first aid on simulated minor wounds and burns.

RESOURCES

- Gauze;
- Gloves;
- Scissors;
- Sterile dressing; and
- Tape.

ACTIVITY LAYOUT

N/A.

ACTIVITY INSTRUCTIONS

1. Divide cadets into pairs.
2. Have one cadet perform first aid for a minor wound (arm or hand) and after, have the other cadet perform first aid for a burn (arm or hand).
3. Rotate through the pairs and make corrections as required.
4. Upon completion, review procedures for treating a minor wound and a first-degree burn.

SAFETY

N/A.

END OF LESSON CONFIRMATION

The cadets' participation in the in-class activity in TP3 will serve as the confirmation of this lesson.

CONCLUSION

HOMEWORK/READING/PRACTICE

N/A.

METHOD OF EVALUATION

N/A.

CLOSING STATEMENT

On expeditions, injuries can occur quickly and without warning. The ability to react quickly by providing on-site help will reduce the discomfort level of the injured person until medical attention is available.

INSTRUCTOR NOTES/REMARKS

N/A.

REFERENCES

C0-102 (ISBN 1-894070-56-9) St. John Ambulance. (2006). *First Aid Training: First on the Scene Student Reference Guide*. Ottawa, ON: St. John Ambulance.

C0-123 St. John Ambulance Canada. (2004). *Seasonal Safety Tips: September 2004 Be Casual, Not a Casualty*. Retrieved 27 February 2007 from http://www.sja.ca/English/safety_tips/September.asp.



ROYAL CANADIAN ARMY CADETS

RED STAR

INSTRUCTIONAL GUIDE



SECTION 5

EO M221.05 – TIE KNOTS

Total Time:

90 min

PREPARATION

PRE-LESSON INSTRUCTIONS

Resources needed for the delivery of this lesson are listed in the lesson specification located in A-CR-CCP-702/PG-001, Chapter 4. Specific uses for said resources are identified throughout the Instructional Guide within the TP for which they are required.

Review the lesson content and become familiar with the material prior to delivering the lesson.

Make copies of knot-tying instructions, located at Annex A.

PRE-LESSON ASSIGNMENT

N/A.

APPROACH

A practical activity was chosen for TP1 as it is an interactive way to allow cadets to experience tying knots. This activity contributes to the development of knot-tying skills and knowledge in a fun and challenging setting.

Demonstration and performance was chosen for TP2 and TP3 as it allows the instructor to explain and demonstrate knot-tying while providing an opportunity for the cadets to practice knot-tying under supervision.

INTRODUCTION

REVIEW

N/A.

OBJECTIVES

By the end of this lesson the cadet shall be expected to coil a rope and tie the following knots:

- bowline;
- fisherman's knot;
- double fisherman's knot; and
- double overhand running knot.

IMPORTANCE

It is important for cadets to know how to tie knots and work with rope. Knots can be used during field training, for building shelters, securing equipment, and also in everyday life.

Teaching Point 1

Review Green Star Knots

Time: 20 min

Method: Practical Activity



Refer to EO M121.03 (Tie Knots and Lashings) for knot-tying instructions.

ACTIVITY

OBJECTIVE

The objective of this activity is to review knots instructed in Green Star. The cadets must have a good knowledge of these knots before moving on to other knots.

RESOURCES

- Six pieces of rope for tying knots (per group);
- Six railings or dowels for tying hitches;
- Sheet of flipchart paper/blackboard/whiteboard; and
- A marker/chalk.

ACTIVITY LAYOUT

An area must be chosen, large enough to accommodate the entire group.

ACTIVITY INSTRUCTIONS

1. On a sheet of flipchart paper/blackboard/whiteboard write the following knots:
 - thumb (overhand);
 - reef (square);
 - figure of eight;
 - double figure of eight;
 - clove hitch; and
 - half hitch.
2. Divide the cadets into equal groups of no more than ten cadets.
3. Within each group, pair up the cadets. If there is an uneven number, a person will have to be paired up twice, so that everyone has a partner. Pairs must have the same dominant hand (two right-handed cadets or two left-handed cadets).

4. All cadets are to stand in line, in their groups, facing their partner.
5. Once instructed to begin, each pair of cadets will begin to tie the listed knots (in the order that they appear). Each cadet will only be allowed to use their dominant hand to tie the knots. The pair will have to work together, both only with one hand.
6. Knot-tying will begin with the first pair. Once they have the knot tied, they will untie it, and then pass the rope to the next pair in their group. Upon receiving the rope, the next pair may begin to tie the first knot. The first pair will tie the next knot on the list, then untie it, and pass the piece of rope down, and so on. Pairs may begin tying as soon as they have been given the rope.
7. Once all knots have been tied, the pair may sit and begin to cheer on the rest of their group.



If there are an uneven number of cadets, the cadets who will be in two groups should be placed at the front of the line and the other cadets should be placed at the back. Once the first pairs are finished, the cadets can move to the back to complete the activity again.

SAFETY

N/A.

CONFIRMATION OF TEACHING POINT 1

The cadets' participation in the activity will serve as the confirmation of this TP.

Teaching Point 2

Explain the Uses of, Demonstrate, and Allow Time to Practice Tying Knots

Time: 50 min

Method: Demonstration and Performance



Provide an explanation and demonstration of the complete knot and then break the knot down into its steps.

Provide a demonstration of each step and have the cadets complete each step. Ensure the cadets have enough time to complete each step.

Each knot must be instructed individually. Distribute handouts with tying instructions (located at Annex A).

A review of the parts of a rope, from EO M121.03 (Tie Knots and Lashings) may be required before beginning TP2.

BOWLINE

Uses. In climbing, it is used as a safety measure during ascent and is clipped into the carabiner. It is often called the rescue knot because it makes a simple loop that does not slip. It can be used to tie around yourself, to throw to someone who needs a lifeline, or to secure objects (such as canoes to a wharf).

Qualities. It does not slip, come loose, or jam.

Faults. It is difficult to untie when the rope is under strain.

Procedure

1. With the standing part of the rope away from you, take the working end in your right hand and place it on top of the standing part.
2. Put your thumb under the standing part.
3. Twist your right hand 180 degrees away from you, to form a simple over hand loop (looks like a number six), and pull the working end up through.
4. Take the working end round behind the standing part.
5. Bring the working end down through the loop. Tighten the bowline by holding on to the bight formed by the end and pulling hard on the standing part.

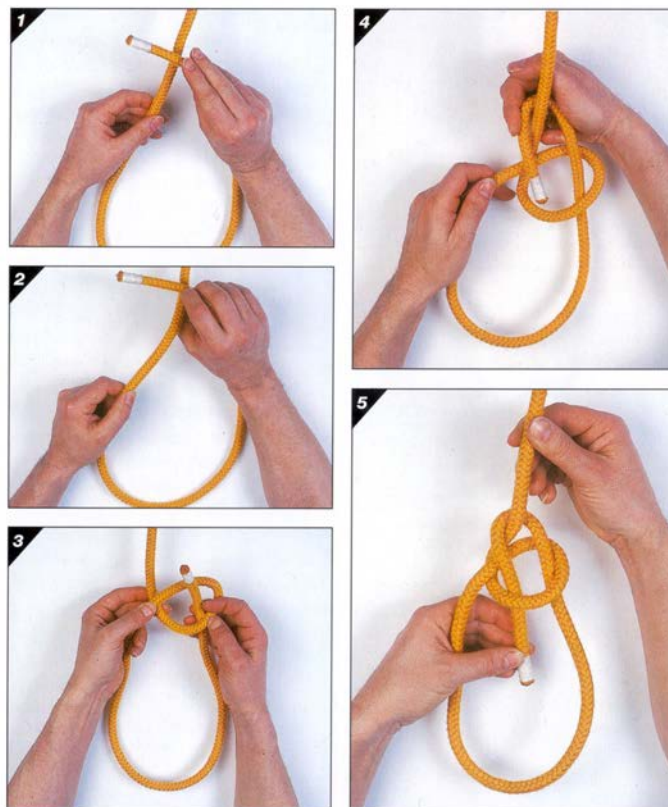


Figure 1 Bowline

Pawson, D., Pocket Guide to Knots & Splices, Chartwell Books, Inc. (p. 164)

FISHERMAN'S KNOT

Uses. To join two pieces of rope together. It is commonly used by anglers and climbers.

Qualities. It does not slip, come loose, or jam.

Faults. It is difficult to untie when fine rope is used.

Procedure

1. Lay the ropes alongside each other, end to end. Take one of the ropes and bring it over the other and under itself.
2. Make an overhand knot around the second rope.
3. Make an overhand knot around the standing part of the first rope.
4. Slide together to complete the knot.
5. Tighten to finish the fisherman's knot.
6. Tape ends if used in climbing to avoid slipping.

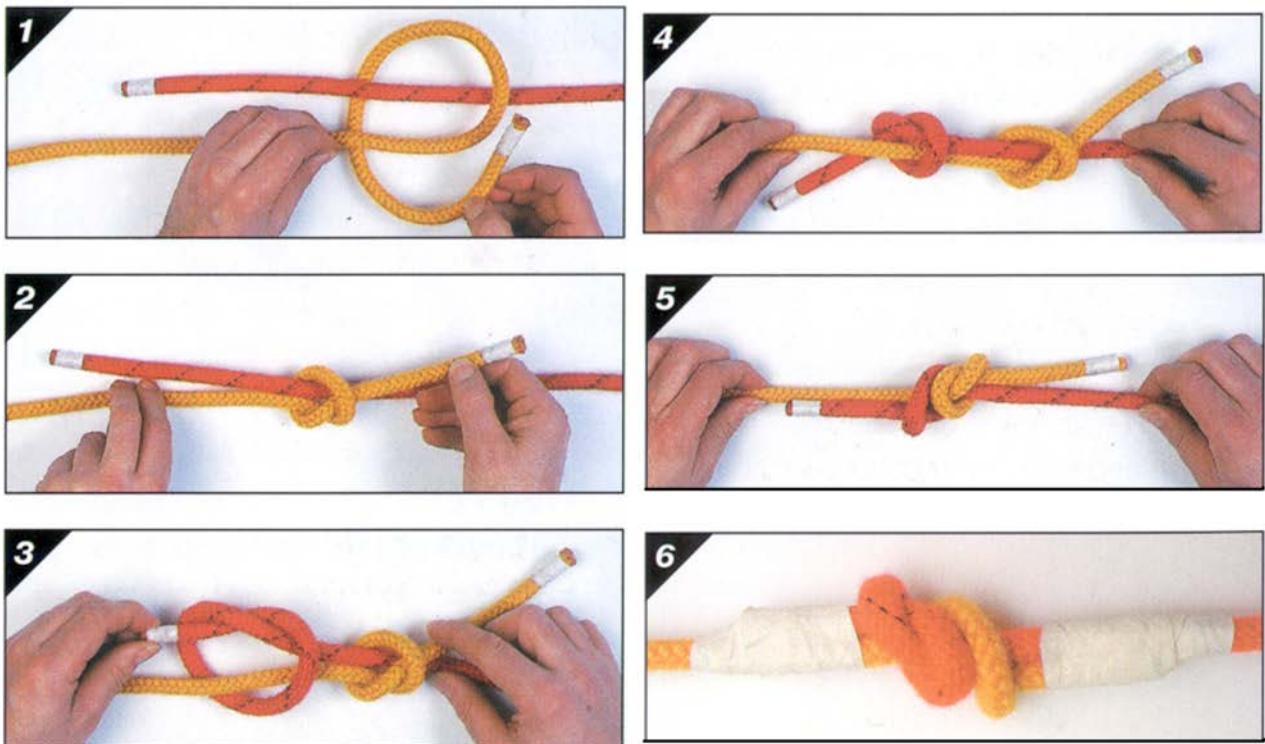


Figure 2 Fisherman's Knot

Pawson, D., Pocket Guide to Knots & Splices, Chartwell Books, Inc. (p. 116)

DOUBLE FISHERMAN'S KNOT

Uses. To join two pieces of rope together. It is commonly used by anglers and climbers. It is ideal for slippery line or rope.

Qualities. It does not slip, come loose, or jam.

Faults. It is difficult to untie when fine rope is used.

Procedure

1. With the first rope, make a double overhand knot around the body of the second rope.
2. Make a double overhand knot around the body of the first rope.
3. Pull tight and slide together. The knots should make “X’s” on the same side.

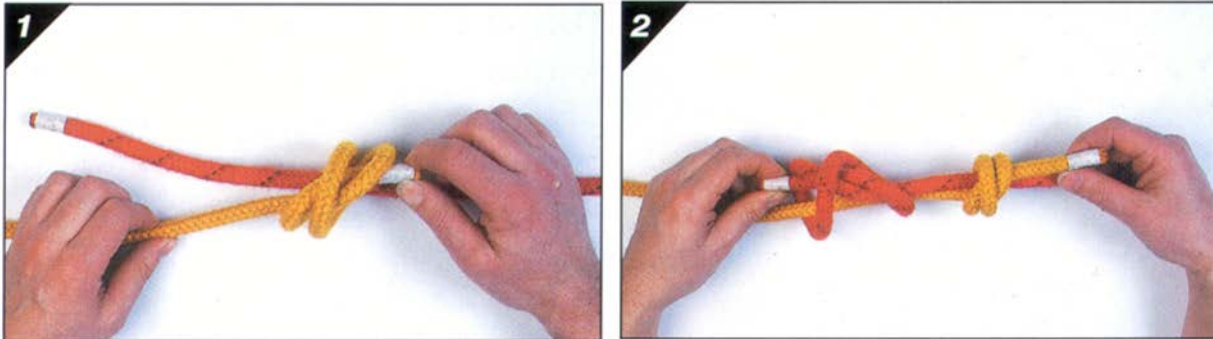


Figure 3 Double Fisherman's Knot Steps 1 and 2

Pawson, D., Pocket Guide to Knots & Splices, Chartwell Books, Inc. (p. 117)



Figure 4 Double Fisherman's Knot Step 3

40th Fife Scout Troop, 2007, Knotting the Thumb Knot. Retrieved 3 May 2007, from <http://www.users.zetnet.co.uk/whitelaw/knots/dfish.jpg>

DOUBLE OVERHAND RUNNING KNOT

Uses. This sliding loop grips tightly around an object. It is ideal for fixing a lanyard fast to the arms of sunglasses or spectacles so they can hang around a person's neck when not in use.

Procedure

1. Make a loop with a fairly long working end on top.
2. With fingers parallel to the standing part, wrap around the standing part three times.
3. Put the working end down through the “tunnel” where the fingers are.
4. Tighten the turns by pulling on the working end, working the turns snugly together.

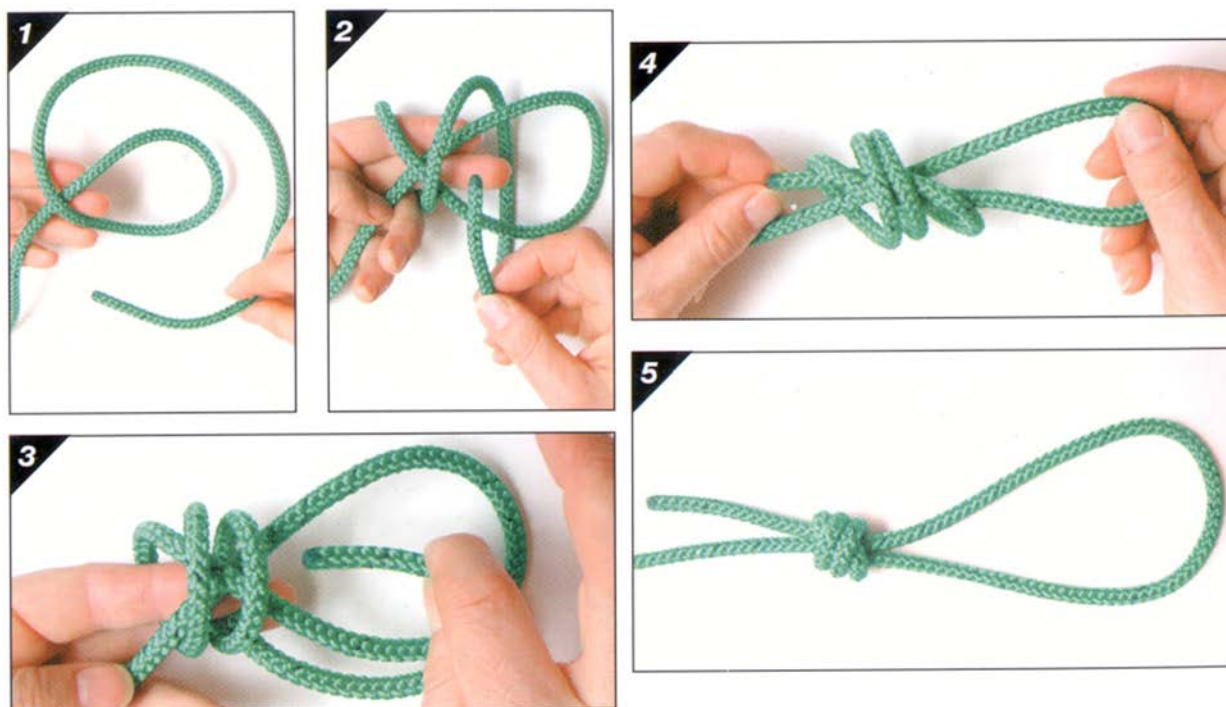


Figure 5 Double Overhand Running Knot

Pawson, D., Pocket Guide to Knots & Splices, Chartwell Books, Inc. (p. 177)



The same knot must be made at the other end of the rope in order to fix it to the arms of sunglasses or spectacles. When two knots are made, the knots can be easily adjusted by pulling on each end to the desired length.

CONFIRMATION OF TEACHING POINT 2

Tie the following knots:

- bowline;
- fisherman's knot;
- double fisherman's knot; and
- double overhand running knot.

Teaching Point 3

Explain the Uses of, Demonstrate, and Allow Time to Practice Coiling a Rope

Time: 10 min

Method: Demonstration and Performance

COILING A ROPE

Ropes should always be coiled because it makes rope storage neat and compact. Otherwise, they will become a mass of knots and tangles. Any rope that is being coiled should be clean and ready to be put away.

Procedure

1. Coiling will be clockwise; however, this may differ for left-handed people. Run your coiling hand (dominant) along the rope until you have about an arm span of rope.
2. Bring your dominant hand towards your holding hand and use your index finger and thumb to twist the line in the direction that the coil is going. Normally, a 180 degree or 360 degree twist will suffice. This will ensure that the rope does not twist or kink when in the coil.
3. Lay the rope into your holding hand. There should be no kinks in the coil.
4. Steps 1–3 will be repeated until there is approximately one metre of rope left.
5. Take the last length of rope and wrap it three or four times around the outside of the coils that were previously made.
6. Make a loop with the remaining rope and thread it through the upper area between the coils and the wraps (not all the way).
7. Open the loop over the top of the coil.
8. Tighten the loop by pulling on its end. The rope is now coiled.



Figure 6 Coiling a Rope

Bigon, M. and Regazzoni, G. The Morrow Guide to Knots, Quill/William Morrow (p. 23)

The dominant hand will be the coiling hand; the non-dominant hand will hold the coiled rope. Prior to beginning, take one end of the rope into the non-dominant hand. Let the end fall about six inches out of your hand, towards you.

CONFIRMATION OF TEACHING POINT 3

The cadets' participation in coiling a rope will serve as the confirmation of this TP.

END OF LESSON CONFIRMATION

The cadets' participation in tying knots and coiling a rope will serve as the confirmation of this lesson.

CONCLUSION

HOMEWORK/READING/PRACTICE

N/A.

METHOD OF EVALUATION

N/A.

CLOSING STATEMENT

Knowing what knots to tie when situations arise is an important aspect of field training and can also be used in everyday life. Being able to construct a quality knot will prove useful in a variety of situations such as climbing, towing, and even making a glasses strap or a strap for sunglasses when other means are not available.

INSTRUCTOR NOTES/REMARKS

N/A.

REFERENCES

C2-007 (ISBN 0-7858-1446-9) Pawson, D. (2001). *Pocket Guide to Knots and Splices*. Edison, NJ: Chartwell Books, Inc.

C2-073 (ISBN 0-688-01226-4) Bigon, M. and Regazzoni, G. (1982). *The Morrow Guide to Knots*. New York, NY: Quill/William Morrow.

THIS PAGE INTENTIONALLY LEFT BLANK

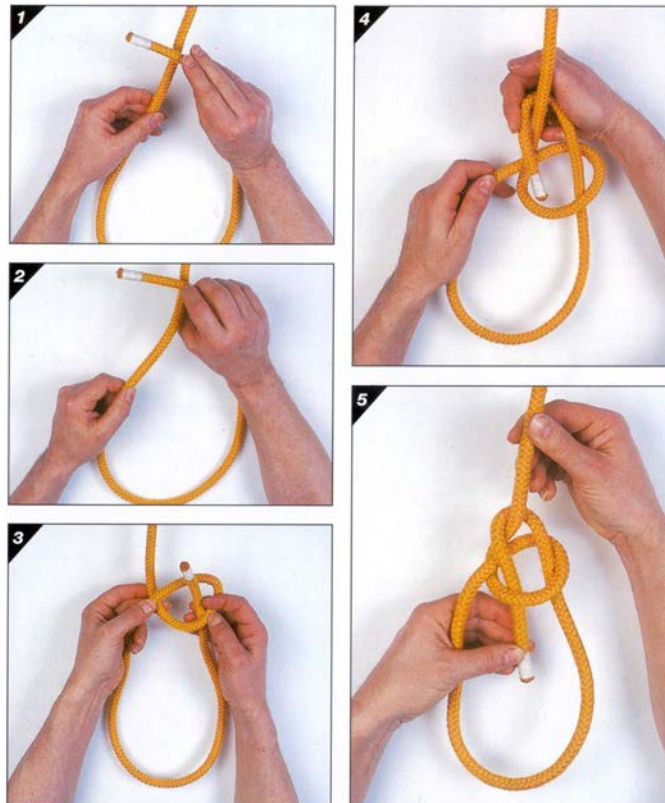
KNOT-TYING INSTRUCTIONS

BOWLINE

Uses. In climbing, it is used as a safety measure during ascent and is clipped into the carabiner. It is often called the rescue knot because it makes a simple loop that does not slip. It can be used to tie around yourself, to throw to someone who needs a lifeline, or to secure objects (such as canoes to a wharf).

Procedure

1. With the standing part of the rope away from you, take the working end in your right hand and place it on top of the standing part.
2. Put your thumb under the standing part.
3. Twist your right hand 180 degrees away from you, to form a simple over hand loop (looks like a number six), and pull the working end up through.
4. Take the working end round behind the standing part.
5. Bring the working end down through the loop. Tighten the bowline by holding on to the bight formed by the end and pulling hard on the standing part.



BOWLINE

Figure A-1 Bowline

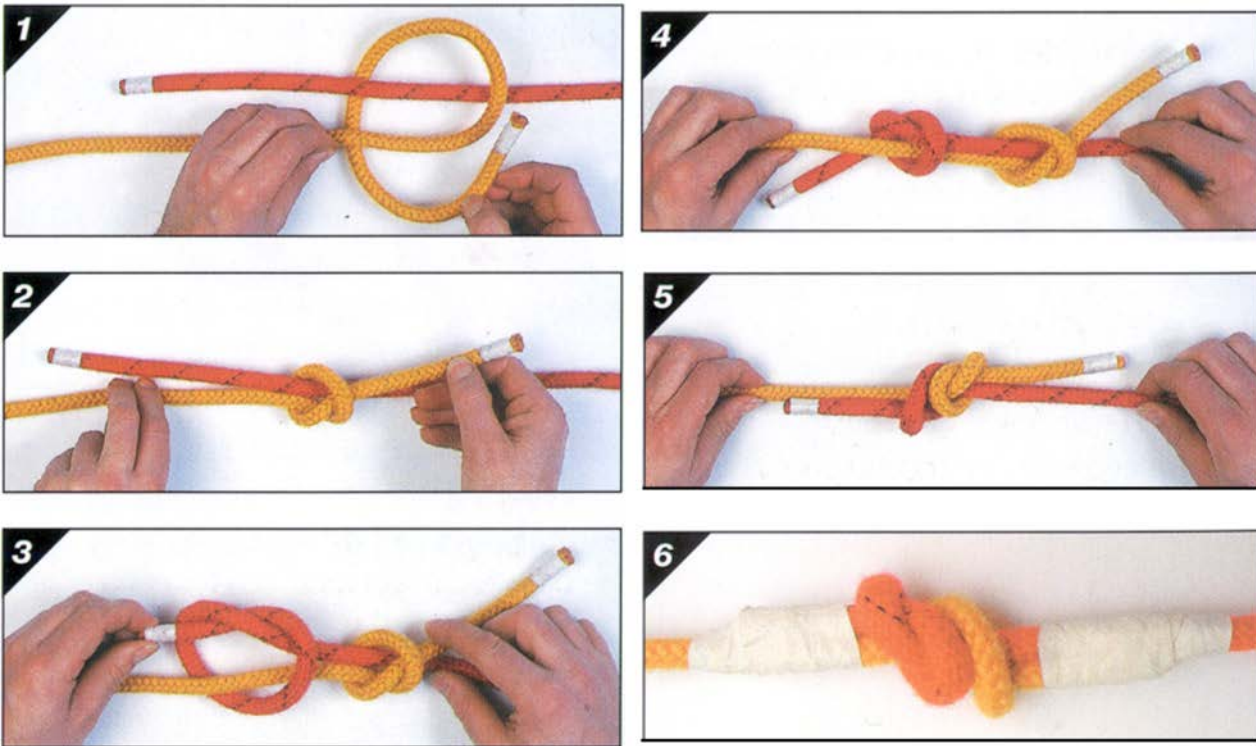
Pawson, D., Pocket Guide to Knots & Splices, Chartwell Books, Inc. (p. 164)

FISHERMAN'S KNOT

Uses. To join two pieces of rope together. It is commonly used by anglers and climbers.

Procedure

1. Lay the ropes alongside each other, end to end. Take one of the ropes and bring it over the other and under itself.
2. Make an overhand knot around the second rope.
3. Make an overhand knot around the standing part of the first rope.
4. Slide together to complete the knot.
5. Tighten to finish the fisherman's knot.
6. Tape ends if used in climbing to avoid slipping.



FISHERMAN'S KNOT

Figure A-2 Fisherman's Knot

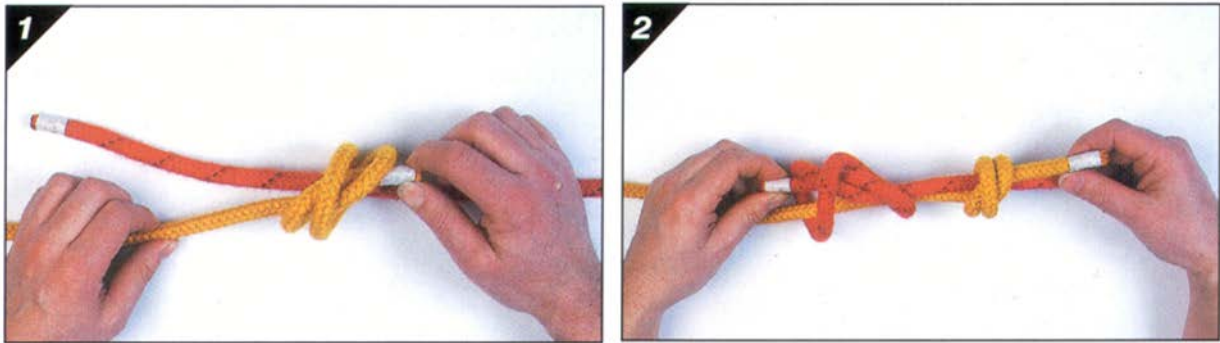
Pawson, D., Pocket Guide to Knots & Splices, Chartwell Books, Inc. (p. 116)

DOUBLE FISHERMAN'S KNOT

Uses. To join two pieces of rope together. It is commonly used by anglers and climbers. It is ideal for slippery line or rope.

Procedure

1. With the first rope, make a double overhand knot around the body of the second rope.
2. Make a double overhand knot around the body of the first rope.
3. Pull tight and slide together. The knots should make "X's" on one side.



STEPS 1 AND 2

Pawson, D., Pocket Guide to Knots & Splices, Chartwell Books, Inc. (p. 117)



STEP 3

40th Fife Scout Troop, 2007, Knotting the Thumb Knot. Retrieved 3 May 2007, from <http://www.users.zetnet.co.uk/whitelaw/knots/dfish.jpg>

Figure A-3 Double Fisherman's Knot

DOUBLE OVERHAND RUNNING KNOT

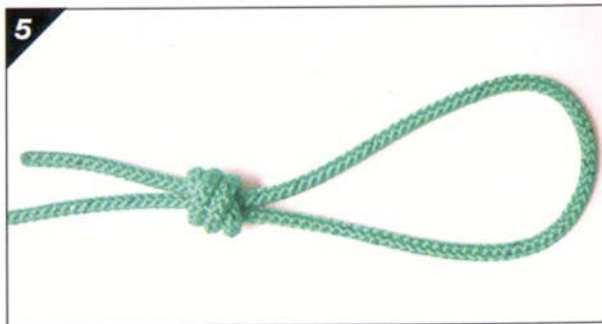
Uses. This sliding loop grips tightly around an object. It is ideal for fixing a lanyard fast to the arms of sunglasses or spectacles so they can hang around a person's neck when not in use.

Procedure

1. Make a loop with a fairly long working end on top.
2. With fingers parallel to the standing part, wrap around the standing part three times.
3. Put the working end down through the "tunnel" where the fingers are.
4. Tighten the turns by pulling on the working end, working the turns snugly together.



The same knot must be made at the other end of the rope in order to fix it to the arms of sunglasses or spectacles. When two knots are made, the knots can be easily adjusted by pulling on each end to the desired length.



DOUBLE OVERHAND RUNNING KNOT

Figure A-4 Double Overhand Running Knot

Pawson, D., Pocket Guide to Knots & Splices, Chartwell Books, Inc. (p. 117)



ROYAL CANADIAN ARMY CADETS

RED STAR

INSTRUCTIONAL GUIDE



SECTION 6

EO M221.06 – CONSTRUCT A HOOCHIE SHELTER

Total Time:

90 min

PREPARATION

PRE-LESSON INSTRUCTIONS

Resources needed for the delivery of this lesson are listed in the lesson specification located in A-CR-CCP-702/PG-001, Chapter 4. Specific uses for said resources are identified throughout the Instructional Guide within the TP for which they are required.

Review the lesson content and become familiar with the material prior to delivering the lesson.

Prior to the lesson, select a site that exemplifies the factors to consider when selecting a site for a hoochie shelter. A hoochie shelter may be constructed prior to beginning this lesson, for illustration purposes.

PRE-LESSON ASSIGNMENT

N/A.

APPROACH

Interactive lecture was chosen for TP1 to present basic or background material on constructing a hoochie shelter.

Demonstration was chosen for TP2 and TP3 to allow the instructor to explain and demonstrate constructing a hoochie shelter.

Performance was chosen for TP4 as it provides an opportunity for the cadets to practice constructing a hoochie shelter under supervision.

INTRODUCTION

REVIEW

N/A.

OBJECTIVES

By the end of this lesson the cadet shall be expected to construct and tear down a hoochie shelter.

IMPORTANCE

It is important for cadets to know how to construct and tear down a hoochie shelter as a method of creating a minimalist shelter during expeditions. In some instances, during expeditions, cadets may prefer to use a lightweight tarp or hoochie shelter for protection from the elements as well as from insects and animals rather than a tent, which would be much heavier.

Teaching Point 1**Explain Factors to Consider When Selecting a Hoochie Site**

Time: 10 min

Method: Interactive Lecture



Have a pre-selected site prepared to construct a hoochie shelter. The area must exemplify factors to consider when selecting a hoochie site.

When selecting a site for a hoochie shelter, the following factors should be considered:

- Two trees approximately two metres (six feet) apart, will provide adequate space for a shelter.
- Cover will provide protection from the elements.
- An elevated area will allow for water drainage.
- Flat ground will provide a comfortable sleeping surface.
- A sheltered area will provide protection from the wind and direct sunlight.
- Checking for dead trees and tree limbs in the immediate area will reduce potential dangers and risks.



Although trees may offer protection, they can be dangerous. Avoid trees with dead branches or on windswept fields, especially trees that lean at pronounced angles. Check above and around the tent site, as trees and branches may fall and hurt or kill someone.

CONFIRMATION OF TEACHING POINT 1**QUESTIONS**

- Q1. When selecting a site for a hoochie shelter, how far apart should the trees be?
- Q2. Why should the site be on an elevated area?
- Q3. When selecting a site, what should one check for to reduce potential dangers and risks?

ANTICIPATED ANSWERS

- A1. The two trees should be approximately six feet apart.
- A2. An elevated area will allow for water drainage.
- A3. Checking for dead trees and tree limbs in the immediate area will reduce potential dangers and risks.

Teaching Point 2**Explain and Demonstrate the Procedure for Constructing and Tearing Down a Hoochie Shelter**

Time: 20 min

Method: Demonstration



This TP should be delivered as the hoochie shelter is constructed. Demonstrate and explain each step.

A previously constructed shelter may be used for illustration.

CONSTRUCTING A HOOCHIE SHELTER**Checking the Groundsheets**

Prior to commencing construction, all materials should be checked for fatigue and wear, especially the two groundsheet, to include:

- Groundsheets should not have holes that would allow rain or other objects into the completed shelter.
- The rubberized interior coating on groundsheet should be checked for deterioration and flaking, which results from age and being stored when still wet.
- Ensure that the two zippers match up and will form a strong bond. Different manufacturers of the groundsheet may use different zippers, which may not fit together properly.
- Grommets on each groundsheet should be in good repair so they can hold pegs/twine effectively.



Figure 1 Grommet

D Cdts 3, 2006, Ottawa, ON: Department of National Defence

Zippering the Groundsheets Together

The two groundsheet are zipped together to form a sufficient bond. Ensure that the two zippers are the same length and are not worn out because the bond may be compromised.



Figure 2 Zipping Groundsheets

D Cdts 3, 2006, Ottawa, ON: Department of National Defence



Figure 3 Joining Groundsheets

D Cdts 3, 2006, Ottawa, ON: Department of National Defence

Tying the Shelter to Trees

Tie each end of the zipped together groundsheets to the two trees by passing the twine through the grommets located at each end of the zipper. A knot that is reliable and will provide stability shall be used such as clove hitch or the overhand knot. The shelter should be tied as high as the waist of the tallest occupant. If tied to the correct grommets the flap of material over the zipper will naturally sit covering the zipper.



Figure 4 Joined Groundsheets

D Cdts 3, 2006, Ottawa, ON: Department of National Defence



Figure 5 Tying the Shelter to a Tree

D Cdts 3, 2006, Ottawa, ON: Department of National Defence

Securing the Groundsheets Between Trees

The shelter, built at waist height, will allow enough head room for someone to sit upright, when completed. The two groundsheets should be pulled as tight as possible between the two trees. This tightness will prevent rain from collecting and will stop the shelter from sagging after extended use. When tying the shelter, ensure that the flap at the peak of the shelter covers the zipper. Make certain there is enough room on one of the ends for an entrance and exit.



Figure 6 Securing Groundsheets

D Cdts 3, 2006, Ottawa, ON: Department of National Defence



Figure 7 Pegging the Grommets

D Cdts 3, 2006, Ottawa, ON: Department of National Defence

Pegging the Grommets

Two grommets are located down the centre of each groundsheet. Twine may be used to tie these grommets to surrounding trees. To create more space in the shelter, tie the grommets to a branch that crosses the apex of the hoochie or use twine and sticks to peg them into the ground.

Pulling the Groundsheets Taut (Tight)

Any objects that will secure each corner of the groundsheets 5 cm above the ground will be sufficient to use as pegs. After the corners are pegged, peg the remaining grommets on each side. When each side of the shelter is pegged, it should result in a flush, taut surface with no wrinkles. This taut surface will allow for efficient run-off of rain.



Figure 8 Groundsheets Pulled Taunt

D Cdts 3, 2006, Ottawa, ON: Department of National Defence

TEARING DOWN A HOOCHIE SHELTER



Tearing down a hoochie shelter will be conducted during the tear down of the bivouac site. The cadets shall, under supervision, tear down their hoochie shelter with their partner.

Tearing down a hoochie takes much less time than constructing one.

To tear down a hoochie:

1. Take all personal equipment out of the hoochie shelter.
2. Cut the twine tying the hoochie shelter to the trees.
3. Pull the pegs from the ground.
4. Pull/cut off any twine used to tie the grommets to the pegs. Make sure there are no sticks left in the grommet holes.
5. Unzip the groundsheets. Shake off any dirt and debris that may have fallen on it.

6. Fold the groundsheets.
7. Return the ground to its original state and clean up garbage.



Groundsheets **must be dry** before they can be folded and stored. They may have to be laid out to dry.

Depending on the quartermaster, groundsheets may be folded or rolled. All must be folded or rolled in the same way and tied so they will not come apart.

CONFIRMATION OF TEACHING POINT 2

QUESTIONS

- Q1. Why do groundsheets need to be checked prior to setting up a hoochie shelter?
- Q2. How high should the shelter be tied?
- Q3. How high off the ground should a hoochie be pegged?

ANTICIPATED ANSWERS

- A1. Groundsheets need to be checked for fatigue and wear.
- A2. Shelters should be at waist height of the tallest occupant.
- A3. A hoochie should be pegged 5 cm off the ground.

Teaching Point 3

Explain and Demonstrate Setting Up Personal Space

Time: 5 min

Method: Demonstration

SETTING UP PERSONAL SPACE

Air Mattress. The air mattress will be placed down the sides of the hoochie shelter.

Sleeping Bag. The sleeping bag will be rolled up and placed at the top of the air mattress. It can be unrolled at bed time.

Rucksack. The rucksack will be placed at the head of the air mattress.

Boots. Boots will be placed at the end of the air mattress, by the entrance.

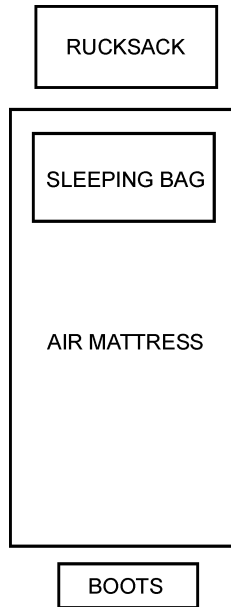


Figure 9 Personal Sleeping Space

D Cds 3, 2007, Ottawa, ON: Department of National Defence

CONFIRMATION OF TEACHING POINT 3

QUESTIONS

- Q1. Will the sleeping bag be rolled or unrolled on the air mattress?
- Q2. Where is the rucksack placed?
- Q3. Where will boots be placed?

ANTICIPATED ANSWERS

- A1. The sleeping bag will be rolled on the air mattress, until you are ready for bed.
- A2. The rucksack is placed at the head of the air mattress.
- A3. Boots will be placed at the end of the air mattress, by the entrance.

Teaching Point 4

Construct a Hoochie Shelter

Time: 45 min

Method: Performance

ACTIVITY

OBJECTIVE

The objective of this activity is for the cadets to construct a hoochie shelter.

RESOURCES

- Groundsheets (one per cadet);
- Sleeping bag (one per cadet);
- Air mattress (one per cadet);
- Twine or bungee cord;
- A knife (one per two cadets); and
- Sticks for pegging.

ACTIVITY LAYOUT

Choose an area in which each pair of cadets can set up a hoochie shelter between two trees that are approximately two metres (six feet) apart.

ACTIVITY INSTRUCTIONS

1. Divide cadets into pairs (same gender).
2. Assign each pair the required resources.
3. Have cadets gather sticks for pegging.
4. Have cadets construct a hoochie.
5. Have cadets organize their personal space.
6. Cadets will check their hoochie shelters to ensure:
 - a. there is room for two people to sleep and sit upright;
 - b. the lines are secure; and
 - c. it is waterproof.

SAFETY

- Cadets will respect boundaries for the activity.
- Cadets will ensure safe tool use at all times.



Inspect the cadets' hoochies to ensure they are well constructed and safe to sleep in.

CONFIRMATION OF TEACHING POINT 4

The cadets' participation in the activity will serve as the confirmation of this TP.

END OF LESSON CONFIRMATION

The cadets' participation in constructing a hoochie shelter and setting up personal space will serve as the confirmation of this lesson.

CONCLUSION

HOMEWORK/READING/PRACTICE

N/A.

METHOD OF EVALUATION

N/A.

CLOSING STATEMENT

Constructing a hoochie is an important skill for Army Cadets. Shelter allows the cadet to stay comfortable and protected while participating in expeditions and weekend bivouac FTXs.

INSTRUCTOR NOTES/REMARKS

Tearing down a hoochie shelter will be confirmed during the tear down of the bivouac site.

REFERENCES

C2-004 (ISBN 1-896713-00-9) Tawrell, P. (1996). *Camping and Wilderness Survival: The Ultimate Outdoors Book*. Green Valley, ON: Paul Tawrell.

C2-008 (ISBN 0-00-265314-7) Wiseman, J. (1999). *The SAS Survival Handbook*. Hammersmith, London: HarperCollins Publishers.



ROYAL CANADIAN ARMY CADETS

RED STAR

INSTRUCTIONAL GUIDE



SECTION 7

EO M221.07 – USE SECTION EQUIPMENT

Total Time: 60 min

Time: 60 min

PREPARATION

PRE-LESSON INSTRUCTIONS

Resources needed for the delivery of this lesson are listed in the lesson specification located in A-CR-CCP-702/PG-001, Chapter 4. Specific uses for said resources are identified throughout the Instructional Guide within the TP for which they are required.

Review the lesson content and become familiar with the material prior to delivering the lesson.

Divide cadets into groups as resources allow.

Coleman stoves and lanterns will be fuelled prior to this lesson.

Obtain logs for cadets to chop and saw.

PRE-LESSON ASSIGNMENT

N/A.

APPROACH

An interactive lecture was chosen for TP1 and TP3 to introduce the safe handling of section equipment when participating in a weekend bivouac FTX.

Demonstration and performance was chosen for TP2, TP4 and TP5 as it allows the instructor to explain and demonstrate the uses of section equipment while providing an opportunity for the cadets to operate this equipment under supervision.

INTRODUCTION

REVIEW

N/A.

OBJECTIVES

By the end of this lesson the cadet shall be expected to use section equipment to include lighting and extinguishing a two-burner stove and a dual-mantle lantern. Cadets are also expected to employ safe tool use.

IMPORTANCE

It is important for cadets to know how to use section equipment to prevent accidents and injuries, and to increase the life of equipment.

Teaching Point 1

Identify the Characteristics of the Two-burner Stove

Time: 5 min

Method: Interactive Lecture



The Coleman two-burner stove Model M425F710C was used in the production of this lesson. However, instructors may substitute another stove when conducting this lesson.

CHARACTERISTICS

The following are characteristics of the Coleman two-burner stove:

- It is capable of operating with a clean, smokeless flame.
- The flame can be quickly extinguished.
- It is easily ignited in cold weather.
- It does not rattle when packed.
- It is easy to refuel.
- It has no noxious odours.
- Fuel in the tank will not spill when being carried in any position.
- It cools off quickly.
- It is easily cleaned and repaired.

Operational Temperature

The Coleman two-burner stove, when shielded from the wind, can be used in temperatures as low as -52°C .

Fuel Type

The stove uses naphtha.

Parts and Accessories



The diagram provided is for part identification, not disassembly purposes.

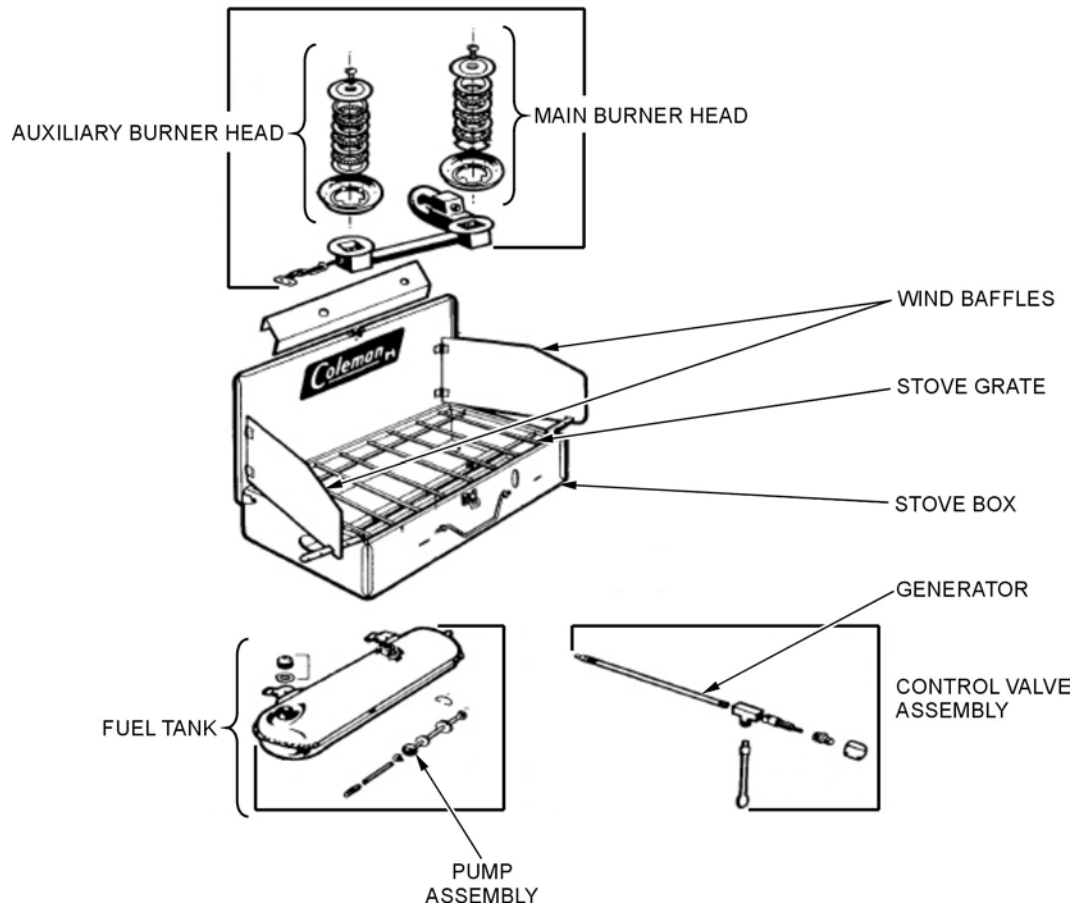


Figure 1 Parts of the Coleman Two-burner Stove

B-GG-302-002/FP-001, Basic Cold Weather Training: Arctic and Sub-arctic Operations (Vol. 2) (p. 2-75)

Stove Box. This is the container in which the burners are stored along with the fuel tank and generator.

Control Valve Assembly. This consists of the valve wheel, nut and body. Its function is to regulate the flow of pressurized fuel from the fuel tank through the generator to the burner head.

Main Burner Head. The main burner head is located on the right of the stove and consists of a burner cap and a small screw with a series of burner rings. The entire assembly sits in a large burner bowl. The main burner control knob is located on the valve and generator assembly.

Auxiliary Burner Head. The auxiliary burner head is located on the left of the stove and consists of a burner cap and small screw along with a series of small burner rings. The entire assembly sits in a small burner bowl. The auxiliary burner control is located on the left side of the stove box.

Pump Assembly. The pump assembly is fitted into the tank and is held in place by a pump cap clip.

Fuel Tank. The fuel tank is red in colour. This tank is only intended to be filled to three quarters full, allowing air in for pressurization. The tank fits on the front of the stove box when in use, and is stored inside the stove box.

Wind Baffles. The wind baffles shelter the burners from wind.

Stove Grate. The stove grate supports pot sets.

Generator. The generator supplies fuel to the burners. Fuel passing through the generator is heated by the main burner.

Precautions

Hazards are few if precautions are taken. Follow these few simple rules:

- Never leave the stove unattended.
- Do not use a stove as a heating device or in enclosed spaces such as buildings, tents or caves.
- Never remove the fuel tank or loosen the filler cap on the fuel tank while the stove is in operation.
- Always fill and light the stove outside in a well ventilated area, away from open flame, heat and combustibles.
- Use only naphtha fuel.
- Store away from open flame or excessive heat.
- Always ensure wind baffles and lid supports are securely positioned before lighting the stove.
- Before transporting or storing, ensure the stove is cool. Loosen the filler cap to release air pressure and retighten. Turn the control knob off.
- If the stove catches light, turn off the fuel supply, close the wind baffles and drop the stove lid.
- When using the stove ensure a fire extinguisher is available.



It is important to stress to cadets that stoves and lanterns must not be used in enclosed spaces such as buildings and tents. The burning of naphtha and other fuels results in the release of carbon monoxide. Carbon monoxide binds with haemoglobin 200 to 250 times better than oxygen, and disrupts almost all physiologic and neurologic systems, even in fairly low concentrations. Because the gas is heavier than air, it pools in the low ground of tents and caves where outdoor enthusiasts sleep, and will not go away – for days even – unless it's forced out by a strong, persistent direct draft of cold air at the height of the pooled gas. Preventing the problem in the first place requires a similarly active draft – at the stove or lantern or below, not at the top of the tent or cave as was once thought. According to one recent research study, asphyxiation in tenting situations kills three times as many people yearly as mountaineering does. Other research has linked even moderate exposure to carbon monoxide to significant long-term effects, including depressed mood, apathy, disorientation, irritability and amnesia – several of which occur in 100 per cent of individuals exposed and can be measure years after the initial exposure. Risks also increase in higher altitudes.

CONFIRMATION OF TEACHING POINT 1

QUESTIONS

- Q1. What is the lowest operational temperature of the Coleman stove?
- Q2. What type of fuel is used in the Coleman stove?
- Q3. What are three precautions to take when operating the Coleman stove?

ANTICIPATED ANSWERS

- A1. When shielded from the wind, it can be used in temperatures as low as -52 °C.
- A2. The Coleman stove uses naphtha.
- A3. Three precautions to take when operating the Coleman stove are:
- Do not use the stove as a heater.
 - Never remove or loosen the filler cap on the fuel tank while the stove is in operation.
 - Never leave the stove unattended.
 - Always fill and light the stove outside, away from open flame, heat and combustibles.
 - Never remove the fuel tank while the stove is in operation.
 - Use only naphtha fuel.
 - Store away from open flame or excessive heat.
 - Always ensure wind baffles and lid supports are securely positioned before lighting the stove.
 - Do not use in dining tents.
 - Before transporting or storing, ensure the stove is cool. Loosen the filler cap to release air pressure and retighten. Turn the control knob off.

Teaching Point 2

Explain, Demonstrate and Have the Cadets Operate a Two-burner Stove

Time: 15 min

Method: Demonstration and Performance



For this skill lesson, it is recommended that instruction take the following format:

1. Explain and demonstrate the complete skill while cadets observe.
2. Explain and demonstrate each step required to complete the skill. Monitor cadets as they imitate each step.
3. Monitor the cadets' performance as they practice the complete skill.

Note: Assistant instructors may be employed to monitor cadet performance.

ASSEMBLY

To assemble the Coleman stove:

1. Unlatch and open the stove (Figure 2).
2. Open and secure the wind baffles (Figure 3).
3. Lift the grate and remove the fuel tank (Figure 4).
4. Install the fuel tank. Ensure the generator passes through the large hole in the front of the stove and is inserted into the opening in the mixing chamber above the burner. Insert hanger brackets on the tank into the slots located on the front of the stove case (Figure 4).

5. Secure the safety chain (Figure 5).
6. Close the grate (Figure 6).
7. Ensure the auxiliary burner valve is in the closed position (Figure 7).



Figure 2 Closed Stove

D Cds 3, 2007, Ottawa, ON: Department of National Defence



Figure 3 Wind Baffles

D Cds 3, 2007, Ottawa, ON: Department of National Defence



Figure 4 Installing the Fuel Tank

D Cdts 3, 2007, Ottawa, ON: Department of National Defence



Figure 5 Securing the Safety Chain

D Cdts 3, 2007, Ottawa, ON: Department of National Defence



Figure 6 Closed Grate

D Cdts 3, 2007, Ottawa, ON: Department of National Defence



Figure 7 Auxiliary Burner Control

D Cmts 3, 2007, Ottawa, ON: Department of National Defence

LIGHTING AND EXTINGUISHING THE COLEMAN STOVE



The Coleman stove fuel tank should have been fuelled previous to this lesson, however, the fuel tank will have to be pressurized through pumping.

Pumping the Fuel Tank

1. Make sure the control knob is in the OFF position.
2. Turn the pump rod two full turns counterclock wise.
3. Place the thumb over the air vent of the pump rod handle.
4. Pump thirty to forty full strokes to pressurize the fuel tank.
5. Turn the pump rod clockwise until it is closed tight.

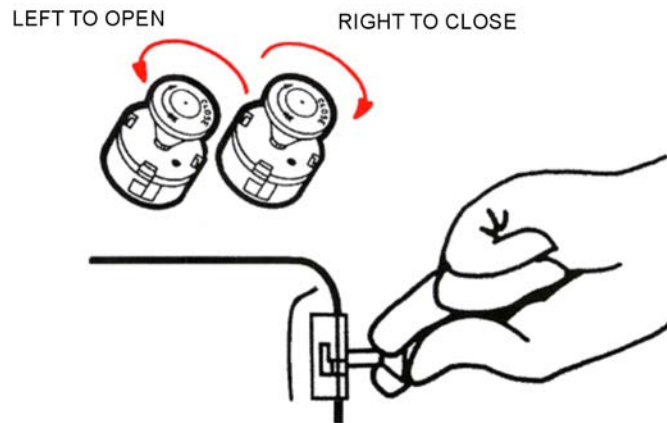


Figure 8 Pumping the Fuel Tank

Coleman Camp Stove Model M425F710C Instructions for use, by The Canadian Coleman Co., Mississauga, ON

Lighting the Main Burner



During colder conditions, it may be necessary to warm the generator prior to lighting. This can be accomplished by applying a small amount of fuel to the main burner directly and lighting it with a match. The burning fuel will heat the generator, heating the fuel inside and facilitating the lighting of the burner. When the generator is not adequately heated it is possible for liquid fuel to pool in the stove which is very dangerous.

1. Ensure the auxiliary valve is in the closed position and the tank is pumped.
2. Do not lean over the stove while lighting.
3. Hold a lit match near the master burner.
4. Turn the instant light lever up to light.
5. Turn the control knob to the LIGHT position or setting.
6. Monitor the flame.
7. When the flame turns blue in colour (approximately one minute), turn the instant light lever down and turn the control knob to the desired heat setting (HI – LO).

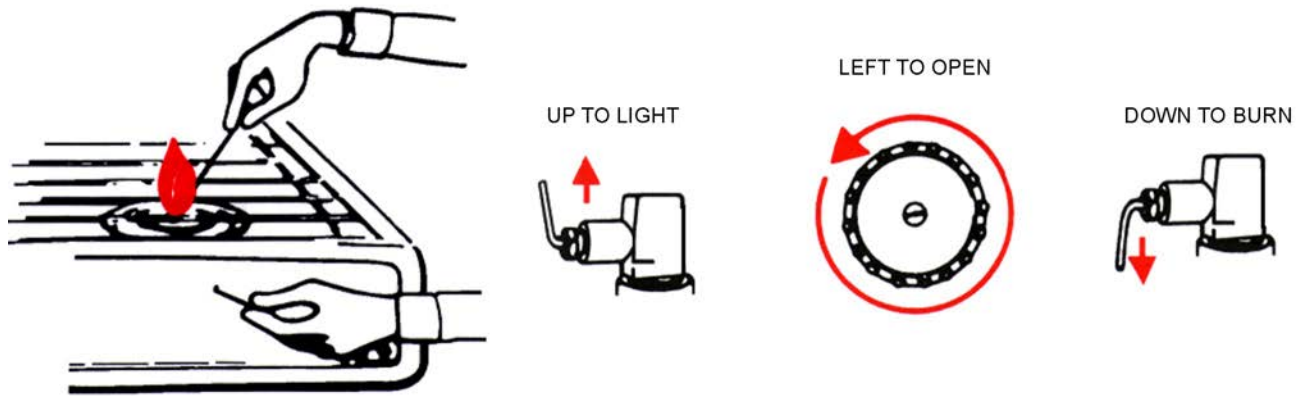



Figure 9 Lighting the Main Burner

Coleman Camp Stove Model M425F710C Instructions for use, by The Canadian Coleman Co., Mississauga, ON


 Should the stove fail to light or the match goes out before ignition, turn the control knob to the OFF position and wait two minutes before attempting to light the stove again.

Lighting the Auxiliary Burner

1. After the main burner has been lit, the auxiliary burner may be lit.
2. Hold a match to the auxiliary burner. Open the auxiliary valve located on the side of the stove box, next to the burner (the main burner may require adjustment after lighting the auxiliary burner).

Extinguishing the Burner

1. Close the auxiliary burner valve.
2. Remove cookware from the stove and turn the instant light lever up to LIGHT position and let burn for one minute. This cleans heavier parts of fuel from the generator.
3. Turn the control knob clockwise to the OFF position and close firmly.

 A small flame on the main burner will continue to burn for a few minutes, until the fuel empties from the generator.

STORING THE COLEMAN STOVE AFTER USE

To store the Coleman stove:

1. Allow the stove to cool before packing.
2. Ensure the stove is clean and any dirt, matches, etc. are emptied from the stove box.
3. Ensure the auxiliary burner valve is in the closed position.
4. Open the grate.
5. Remove the safety chain.

6. Uninstall the fuel tank and remove it from the generator.
7. Place the fuel tank inside the stove box.
8. Close the grate.
9. Close and fold in the wind baffles.
10. Close the cover and latch the box.
11. Store the stove in a cool, dry location.

CONFIRMATION OF TEACHING POINT 2

QUESTIONS

- Q1. How is the Coleman stove assembled?
- Q2. How many pumps pressurize a fuel tank?
- Q3. What is the first step in extinguishing the Coleman stove?

ANTICIPATED ANSWERS

- A1. To assemble the Coleman stove complete the following steps:
 1. Unlatch and open the stove.
 2. Open and secure the wind baffles.
 3. Lift the grate and remove fuel tank.
 4. Install the fuel tank. Ensure that the generator passes through the large hole in the front of the stove and is inserted into the opening in the mixing chamber above the burner. Insert hanger brackets on the tank into the slots located on the front of the stove case.
 5. Secure the safety chain.
 6. Close the grate.
 7. Ensure auxiliary burner valve is in the closed position.
- A2. Pump thirty to forty full strokes to pressurize a fuel tank.
- A3. The first step in extinguishing the Coleman stove is close the auxiliary burner valve.

Teaching Point 3

Identify the Characteristics of the Dual-mantle Lantern

Time: 5 min

Method: Interactive Lecture

CHARACTERISTICS

Coleman lanterns are designed to burn naphtha—a very flammable liquid fuel. This fuel is pressurized in a tank attached to the unit, heated in a generator and then burned as a gas. For best results, keep lanterns clean and in good working condition.

The characteristics of the dual-mantle Coleman lantern include:

- a weight of 2.25 kg (5 lbs); and
- a 1 L fuel tank capacity which allows 7 hours of burn time on HIGH and 14 hours on LOW.

Parts and Accessories

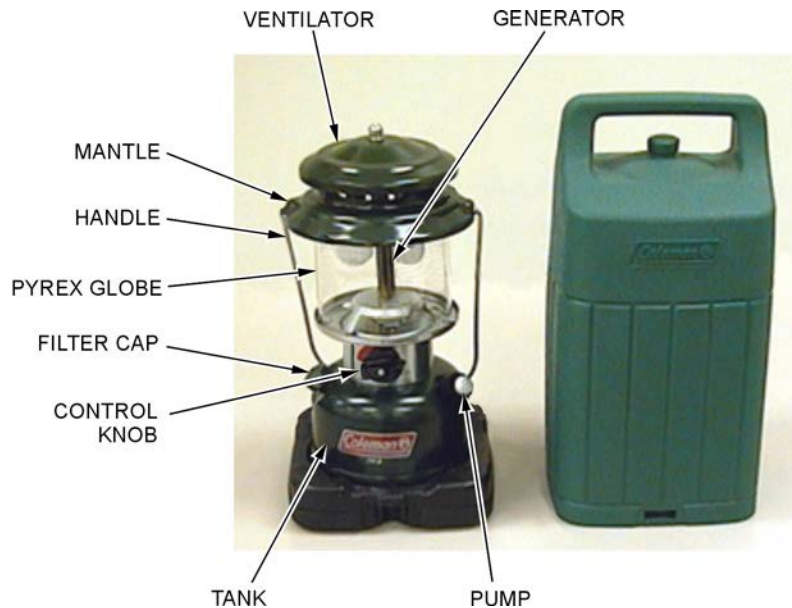


Figure 10 Coleman Dual-mantle Lantern

D Cds 3, 2007, Ottawa, ON: Department of National Defence

Ventilator. Allows for heat and exhaust to evacuate the lantern.

Generator. Provides pressurized fuel to the mantle.

Mantle. Emits a bright light by the burning naphtha fuel.

Handle. Allows the user to carry or hang the lantern.

Pyrex Globe. Protects the mantle from foreign debris. The globe also reduces the amount of oxygen entering the lantern.

Filter Cap. Seals the fuel tank.

Control Knob. Controls the amount of fuel entering the generator, controlling the brightness of the lantern.

Tank. Is a fuel storage reservoir.

Pump. Pumps air into the fuel tank, pressurizing the tank.

Precautions

Hazards are few when precautions are taken. In addition to the precautions taken with stoves caution must be taken to ensure that lantern mantles with holes in them are replaced prior to use.

CONFIRMATION OF TEACHING POINT 3

QUESTIONS

- Q1. What is the fuel capacity of the dual-mantle tank?
- Q2. Where should the lantern be used?
- Q3. What is the purpose of the handle?

ANTICIPATED ANSWERS

- A1. The dual-mantle lantern fuel tank holds 1 L.
- A2. The lantern should be used in ventilated or open areas.
- A3. The handle allows the user to carry or hang the lantern.

Teaching Point 4

Explain, Demonstrate and Have the Cadets Practice Operating the Dual-mantle Lantern

Time: 10 min

Method: Demonstration and Performance



For this skill lesson, it is recommended that instruction take the following format:

1. Explain and demonstrate the complete skill while cadets observe.
2. Explain and demonstrate each step required to complete the skill. Monitor cadets as they emulate each step.
3. Monitor the cadets' performance as they practice the complete skill.

Note: Assistant instructors may be employed to monitor cadet performance.

ASSEMBLY

The lantern does not require assembly or disassembly except replacing the mantles. Before operating the lantern, the cadet should verify that the handle is in place and that the screw on top of the ventilator is tight.

LIGHTING AND EXTINGUISHING THE COLEMAN DUAL-MANTLE LANTERN



The lantern should have been fuelled previous to this lesson; however, the lantern will have to be pressurized through pumping. When a mantle is replaced it should be burned prior to use. By burning the mantle, the mantle shrinks down in size ensuring that combustion of the fuel takes place at the mantle. When the mantle is not burned prior to use fuel can leak out of the mantle prior to combustion.

Pumping the Fuel Tank

1. Make sure the control knob is in the OFF position.
2. Turn the pump rod two full turns counterclockwise.
3. Place the thumb over the air vent of the pump rod handle.

4. Pump thirty to forty full strokes to pressurize the fuel tank.
5. Turn the pump rod to clockwise until it is closed tight.

Lighting the Lantern



Do not position the hands or head above the lantern when lighting. Mantles are very fragile and shall be avoided when using a match to light the lantern.

1. Insert a lit match through the hole in the bottom of the burner frame.
2. Turn the control knob to the LIGHT position.
3. When the mantle burns bright white, turn the control knob to the ON position.
4. Add more air pressure to the tank. Air pressure may be added while the lantern is in operation. Good air pressure is important for maximum light output.

Extinguishing the Lantern

1. Turn the control knob to the OFF position.
2. Allow the remaining fuel to burn off.

STORING THE LANTERN AFTER USE

To store the Coleman lantern:

1. Ensure the lantern is cool.
2. Wipe and clean away any dirt.
3. Drain the fuel into a fuel storage container.
4. Place in a cool, dry location.

CONFIRMATION OF TEACHING POINT 4

QUESTIONS

- Q1. How many pumps pressurize a lantern fuel tank?
- Q2. Where is the match inserted to light the lantern?
- Q3. How is a lantern extinguished?

ANTICIPATED ANSWERS

- A1. Pump thirty to forty full strokes to pressurize a lantern fuel tank.
- A2. Insert a lit match through the hole in the bottom of the burner frame.
- A3. To extinguish, turn the control knob to the OFF position and allow the lantern to burn off the remaining fuel.

Teaching Point 5**Explain, Demonstrate and Have the Cadets Practice Safely Handling of Field Tools**

Time: 15 min

Method: Demonstration and Performance



For this skill lesson, it is recommended that instruction take the following format:

1. Explain and demonstrate the complete skill while cadets observe.
2. Explain and demonstrate each step required to complete the skill. Monitor cadets as they imitate each step.
3. Monitor the cadets' performance as they practice the complete skill.

Note: Assistant instructors may be employed to monitor cadet performance.



When using tools, everyone should:

- Store tools in a secure place. Never leave them lying around or touching the ground.
- Always use the right tool for the job.
- Follow the safety procedures for using the equipment.
- Keep the edges and blades sharp and handles tight.
- Clean and lightly oil steel parts before storage.

AXE

Before using an axe, the tightness of the handle should be checked. If it is loose, the wedge needs to be driven further down or a new wedge should be made using hardwood. The handle must not be cracked or split.

Determining Sharpness

The axe blade should be sharp. If it is not, it can be dangerous, as it will not bite/cut properly and will tend to glance/skip off the wood being cut. Greater force will be required to use it, sacrificing control. A file is best for removing burrs (chips) on the axe blade, and a whetstone for sharpening the edge.

Holding

The axe should be carried by holding it by the handle just below the head, the cutting edge in front and pointing slightly away from the person.

Before storing, the axe should be carefully cleaned and put back in its sheath. When outdoors, the axe can also be driven into the dry stump of a dead tree when not in use.

Chopping Angle

To maximize chopping, cuts should be made at angles of 45 degrees. At angles less than 45 degrees, the axe can deflect off the tree. This can be very dangerous. At angles greater than 45 degrees, the axe will be ineffective as the blade will not chip away pieces of wood but just insert itself into the tree.

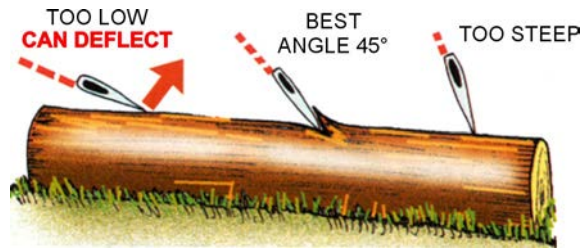


Figure 11 Chopping Angle

Tawrell, P., Camping and Wilderness Survival, Leonard Paul Tawrell (p. 409)

Direction of Fall

When using an axe to cut a tree:

1. Plan an escape route in case the tree falls toward you. Beware of hornets or wasp's nests.
2. Check that the axe is sharp and the head is secure on the handle.
3. Set up a safe distance from other people.
4. Remove any branches and nearby shrubs that can deflect the axe.
5. Secure footing.
6. Swing with short, smooth strokes. This will keep one on target.
7. Cuts are most efficient at 45 degree angles and easily eject wood chips.
8. Check the direction of lean.
9. Carefully cut until the tree is ready to fall. When the tree falls and other people are present, yell **TIMBER!**

The first cut should be made on the side of the tree facing the direction of the desired fall. This is often decided by the lean of the tree. The cut should not be more than halfway through the tree. The back cut commences slightly above and opposite the first cut. Both cuts should be at 45 degree angles.

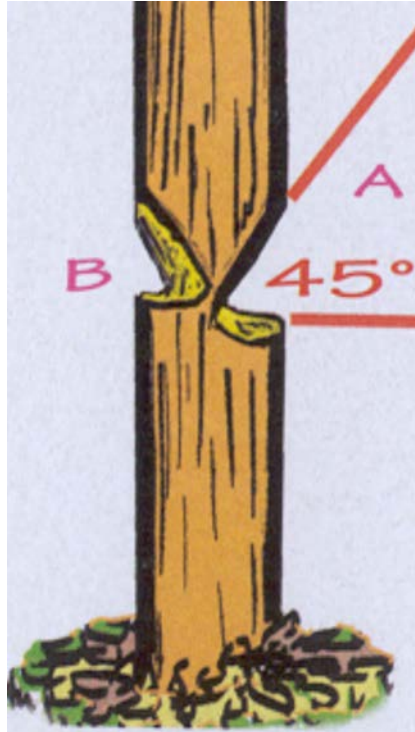


Figure 12 Direction of Fall

Tawrell, P., Camping and Wilderness Survival, Leonard Paul Tawrell (p. 496)

BOW SAW

Holding and Cutting a Log

When using a bow saw to cut wood:

1. Use steady strokes without excessive weight on the blade.
2. Ensure the wood is secured by using a log support. This will help prevent the saw from getting pinched by the log, allowing the weight of the cut end to open the cut (Figure 12).

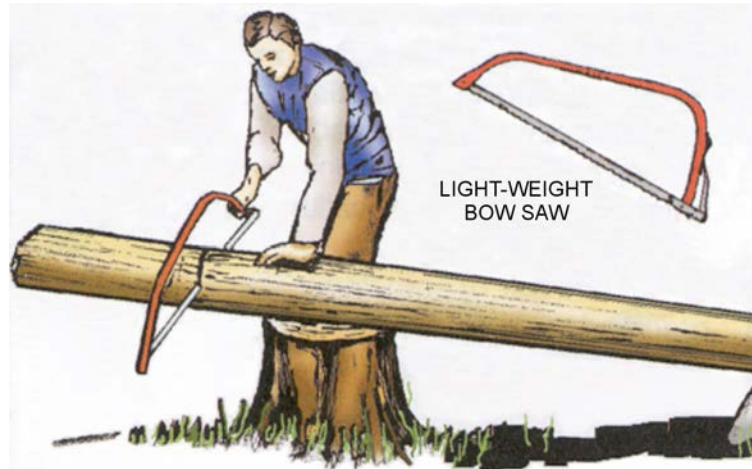


Figure 13 Cutting a Log

Tawrell, P., Camping and Wilderness Survival, Leonard Paul Tawrell (p. 500)

Direction of Fall

When using a bow saw to cut a tree:

1. Chop a notch with an axe in the direction the tree is to fall. This is called a bridge.
2. Saw on the opposite side of the tree from the notch, one or two inches above the lower surface of the notch (see Figure 14). This is very important because if sawn below the notch, the tree can kick back, pinch the blade and may go out of control.
3. Withdraw the saw when the tree starts to fall. The tree will fall with the help of the bridge.

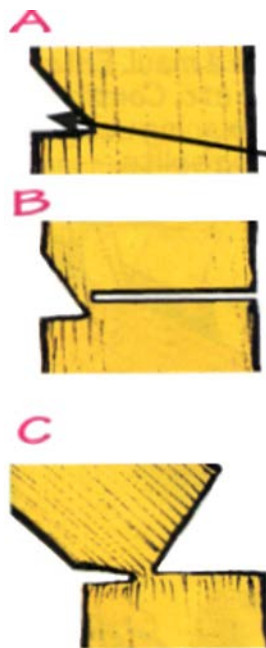


Figure 14 Cutting a Tree With a Saw

Tawrell, P., Camping and Wilderness Survival, Leonard Paul Tawrell (p. 500)

ACTIVITY

Time: 10 min

OBJECTIVE

The objective of this activity is to practice chopping and sawing a log.

RESOURCES

- Logs for cadets to chop and saw;
- 1 axe per group; and
- 1 bow saw per group.

ACTIVITY LAYOUT

N/A.

ACTIVITY INSTRUCTIONS

1. Divide cadets into groups of no more than five.
2. Cadets will cut and saw a log of wood using an axe and a bow saw.
3. Every cadet will be given an opportunity to cut and saw.

SAFETY

Cadets will be directly supervised by an instructor employing safe tool handling at all times.

CONFIRMATION OF TEACHING POINT 5

QUESTIONS

- Q1. What should be checked on an axe before using it?
- Q2. What angle will maximize the chop of an axe?
- Q3. What type of strokes should be used when sawing?

ANTICIPATED ANSWERS

- A1. Before using an axe, the tightness of the handle should be checked. The handle must not be cracked or split and the axe blade should be sharp.
- A2. A 45 degree angle will maximize the chop of an axe.
- A3. Use steady strokes without excessive weight on the blade.

END OF LESSON CONFIRMATION

QUESTIONS

- Q1. What should be oiled on an axe after use?
- Q2. What is the lowest operational temperature of the Coleman Stove?
- Q3. Why do cadets not use Coleman Stoves or Lanterns in an enclosed space?

ANTICIPATED ANSWERS

- A1. The steel head on an axe should be oiled after use.
- A2. When shielded from the wind, the lowest operational temperature of a Coleman stove is -52° C.
- A3. Stoves and Lanterns produce carbon monoxide which binds with haemoglobin resulting in effects such as depressed mood, apathy, disorientation, irritability, amnesia and even death.

CONCLUSION

HOMEWORK/READING/PRACTICE

N/A.

METHOD OF EVALUATION

N/A.

CLOSING STATEMENT

During a weekend bivouac FTX, everyone will use tools to construct portions of the bivouac site. It is key to know how to use the tools and equipment provided, as it will help ensure everyone's safety and will help keep the tools in good condition.

INSTRUCTOR NOTES/REMARKS

Fire extinguishers shall be located within 15 m of operating stoves and lanterns.

REFERENCES

A2-010 B-GG-302-002/FP-001 FMC (1982). *Basic Cold Weather Training: Arctic and Sub-arctic Operations* (Vol. 2). Ottawa, ON: Department of National Defence.

C0-111 (ISBN 978-0-9740820-2-8) Tawrell, P. (2006). *Camping and Wilderness Survival: The Ultimate Outdoors Book* (2nd ed.). Lebanon, NH: Leonard Paul Tawrell.



ROYAL CANADIAN ARMY CADETS

RED STAR

INSTRUCTIONAL GUIDE



SECTION 8

EO M221.08 – PREPARE AN INDIVIDUAL MEAL PACKAGE (IMP)

Total Time:

30 min

PREPARATION

PRE-LESSON INSTRUCTIONS

Resources needed for the delivery of this lesson are listed in the lesson specification located in A-CR-CCP-702/PG-001, Chapter 4. Specific uses for said resources are identified throughout the Instructional Guide within the TP for which they are required.

Review the lesson content and become familiar with the material prior to delivering the lesson.

Immediately prior to this lesson bring water to a boil and have it waiting at a simmer. This water will be used to heat the IMP. Also, have some potable water boiled and ready for any additional food items in the IMP that require hot water.

PRE-LESSON ASSIGNMENT

N/A.

APPROACH

An interactive lecture was chosen for TP1 and TP2 to introduce the cadets to meal preparation in the field and to generate interest.

Demonstration and performance was chosen for TP3 as it allows the instructor to explain and demonstrate how to prepare an IMP while providing an opportunity for the cadets to practice under supervision.

INTRODUCTION

REVIEW

N/A.

OBJECTIVES

By the end of this lesson the cadet shall be expected to prepare an IMP.

IMPORTANCE

It is important for cadets to know how to prepare the different components of an IMP. The IMP will provide energy to fuel the body enabling a cadet to continue tasks and activities in the field. The IMP is most often consumed during expeditions in the absence of kitchen facilities.

Teaching Point 1**Discuss Field Meals**

Time: 5 min

Method: Interactive Lecture



Cadets may have some knowledge of the different types of rations available from Green Star or the General Training Course.

Provide the cadets with as many visual examples as possible. This lesson is conducted in the field, so fresh and IMP meals should be available. If hay boxes are available be sure to use them as an example.

TYPES OF FIELD MEALS

Eating regularly in the field is a very important aspect of maintaining strength and energy. Even though a cadet may be preoccupied, it is important to eat as much healthy food as possible when engaged in physical outdoor activities. Cold weather, strenuous exercise and constant activity require a lot of energy. Only a good, healthy meal can replace energy.

Fresh Rations

Fresh rations are raw food prepared in the field. Fresh rations require preparation and cooking. This type of ration usually does not store/keep well and must be cooked within a day of entering the field (e.g. hot dogs, hamburgers, steak, eggs, etc.).

Hay Boxes

Hay boxes contain fresh rations that have been prepared by a kitchen facility. The food is stored in insulated containers (hay boxes) that continue to keep this food warm without fuel (the warm metal inserts are kept warm because of the food stored within). A hay box is very similar to a thermos – keeping cold food cold or hot food hot.

Box Lunches

These meals are made as a replacement for meals that would normally be consumed at a kitchen. They may be used for planned trips where, either as a result of the timings or the route used, kitchen facilities are not accessible for meals. Box lunches usually contain sandwiches, fruit, veggies, juice, etc.

IMPs

Each IMP includes a main course (meat or vegetarian), vegetables and fruit in sealed foil pouches, and dried foods in paper/tinfoil pouches. All of the food items are safe to eat cold and dry—they may not taste as good as hot food, though. High sugar items like chocolate, hard candies, drink mixes, as well as coffee and tea are also included.

IMPs were developed to meet a typical day's three meal requirement. These meals are identified as breakfast, lunch and supper. They contain between 1400 and 1800 calories—enough calories for an adult performing strenuous tasks for prolonged periods. If inactive or working at lower levels of effort, eating IMPs could cause a person to gain weight.

WATER REQUIREMENTS

Bringing Water to the Field. When warming/heating IMPs, potable water is not required. Pond, lake or spring water that has not been filtered or treated will suffice.

Water Used for Cooking IMPs Is Not Potable. The water used for cooking IMPs may become contaminated with aluminium oxide from the outside of the IMP pouches. This makes the water unsafe to drink and should be treated as grey (washing) water and disposed of appropriately.

Boiling or Treating Water From Unknown Sources. When drawing water from any source that may not be safe, it must be boiled rapidly for 5 minutes before it is consumed.

CONFIRMATION OF TEACHING POINT 1

QUESTIONS

- Q1. What are the four types of rations available?
- Q2. IMPs are identified by what type of meals?
- Q3. Can water from boiled IMPs be consumed?

ANTICIPATED ANSWERS

- A1. Fresh, box lunches, hay boxes and IMPs.
- A2. Breakfast, lunch and supper.
- A3. No. The water becomes contaminated with aluminium oxide from the outside of the IMP pouches.

Teaching Point 2

Discuss the Characteristics and Contents of an IMP

Time: 5 min

Method: Interactive Lecture



During this TP, if available, have two IMPs. One breakfast meal and either a lunch or supper meal is best.

Describe the physical look of the IMP and discuss each item contained within. Give examples of how to use each item.

Show the difference in items between the breakfast and the other meals, note the cereal and hot chocolate items.

CHARACTERISTICS OF AN IMP

The IMP is a small-packaged meal that:

- is no bigger than a large dictionary;
- weighs 850 grams (14 ounces, one pound is equal to 16 ounces);
- contains approximately 1400 to 1800 calories;
- is available in three different meal types—breakfast, lunch and supper. Each type of meal has six different courses; and
- contains some similar contents.

CONTENTS OF AN IMP

	BREAKFAST	LUNCH	SUPPER
COMMON	1. Main meal pouch 2. Dessert pouch 3. Matches 4. Paper towel 5. Spoon 6. Beverage crystals		
MEAL-SPECIFIC	1. Coffee and hot chocolate with condiments 2. Cereal	1. Coffee and tea with condiments 2. Chocolate bar 3. Bread/crackers and jam	1. Coffee and tea with condiments 2. Chocolate bar or cookies 3. Soup 4. Side dish
Note: contents change yearly. This list is intended to identify the key items in an IMP.			

CONFIRMATION OF TEACHING POINT 2**QUESTIONS**

- Q1. How heavy is an IMP?
- Q2. What is the approximate size of an IMP?
- Q3. Name five items that are common to each IMP.

ANTICIPATED ANSWERS

- A1. About 850 grams or 14 ounces.
- A2. No bigger than a large dictionary.
- A3. Main meal pouch, dessert pouch, spoon, paper towel, and matches.

Teaching Point 3

Explain, Demonstrate, and Allow Time for the Cadets, as a Group, to Prepare and Cook IMPs

Time: 15 min

Method: Demonstration and Performance



Issue each cadet an IMP for their next meal. Demonstrate preparing an IMP for cooking and have cadets follow along.

Explain how to use each item in the IMP.

COOKING IMPS

Although IMPs can be consumed cold, they should be heated when possible. Cooking IMPs is simply a matter of:

1. placing the foil pouch, with the entrée sealed inside, in boiling water;
2. heating for 5 minutes and then removing the pouch from the boiling water;
3. placing the pouch back into the cardboard package from which it came (tear a strip off the top of the package to allow easier access to the food); and
4. tearing open the foil pouch and enjoying.



IMPs require only a small amount of water to heat. The heat produced from boiling water and steam is very effective when heating the foil package.

Other food articles will have specific instructions, such as adding water, for their preparation.

Each IMP contains paper, cardboard and foil garbage. One way of reducing the amount of excess garbage that will have to be carried is to “break down” the rations before packing. This entails selecting only the food items that will be consumed and leaving behind the extra packaging. Always carry extra food as a person is often hungrier when performing physical activity than when packing.

ACTIVITY

Time: 10 min

OBJECTIVE

The objective of this activity is to have cadets prepare an IMP for a meal.

RESOURCES

- IMP (one per cadet);
- 2 Pots (large enough to hold IMPs and to boil potable water);
- Fuelled two-burner naphtha stove;
- Pot set;
- Potable water; and
- Matches.

ACTIVITY LAYOUT

Designated cooking area in a field setting.

ACTIVITY INSTRUCTIONS

1. Provide each cadet with an IMP meal appropriate for the time of day.
2. Have cadets follow along, preparing their IMPs for consumption.

3. Explain and demonstrate how to use, heat and consume all items in the IMP.
4. Cadets will consume the IMP they prepared following the tips they have learned.

SAFETY

Ensure caution when operating stoves and handling the IMPs once they are removed from the hot water. Caution, the boiling water produces a very hot steam that can scald the skin, causing a serious burn.

CONFIRMATION OF TEACHING POINT 3

The cadets' participation in the activity in TP3 will serve as a confirmation of this lesson.

END OF LESSON CONFIRMATION

The cadets' participation in the activity in TP3 will serve as a confirmation of this lesson.

CONCLUSION

HOMEWORK/READING/PRACTICE

N/A.

METHOD OF EVALUATION

N/A.

CLOSING STATEMENT

An IMP provides nutrients and energy for the active Army Cadet, especially during vigorous expedition training. Learning to prepare IMPs contents is a skill that will be needed while taking part in expedition training.

INSTRUCTOR NOTES/REMARKS

This lesson is best instructed prior to a meal hour.

REFERENCES

A2-042 A-85-269-001/FP-003 Canadian Forces. (1986). *Food Service Manual: Field Feeding* (Vol. 1). Ottawa, ON: Department of National Defence.



ROYAL CANADIAN ARMY CADETS

RED STAR

INSTRUCTIONAL GUIDE



SECTION 9

EO M221.09 – MAINTAIN SECTION EQUIPMENT FOLLOWING A FIELD TRAINING EXERCISE (FTX)

Total Time: 60 min

PREPARATION

PRE-LESSON INSTRUCTIONS

Resources needed for the delivery of this lesson are listed in the lesson specification located in A-CR-CCP-702/PG-001, Chapter 4. Specific uses for said resources are identified throughout the Instructional Guide within the TP for which they are required.

Review the lesson content and become familiar with the material prior to delivering the lesson.

This lesson is intended to be conducted following a weekend bivouac FTX. The equipment used on the FTX will be used as training aids, to include:

- a Coleman two-burner stove,
- a dual-mantle lantern,
- a pot set,
- a axe,
- a bow saw,
- a groundsheet,
- a bucket/wash basin, and
- rags.

Divide the cadets into groups of no more than four. Provide each group with basin of water and a rag or cloth. During each TP each group should be given a piece of the equipment being discussed. Have cadets follow along with the instruction, maintaining the equipment as it is covered.

PRE-LESSON ASSIGNMENT

N/A.

APPROACH

Demonstration and performance was chosen for this lesson as it allows the instructor to explain and demonstrate the cleaning and storing of section equipment while providing an opportunity for the cadets to practice these skills.

INTRODUCTION

REVIEW

N/A.

OBJECTIVES

By the end of this lesson the cadet shall be expected to maintain section equipment.

IMPORTANCE

It is important for cadets to learn how to maintain section equipment. Cleaning and storing equipment prolongs the life of the equipment. Through regimented cleaning practices, equipment will be slow to corrode and rust ensuring a long life.

Teaching Point 1

**Explain, Demonstrate and Have the Cadets Practice
Cleaning and Storing a Two-burner Stove**

Time: 10 min

Method: Demonstration and Performance



Provide each group with a Coleman two-burner stove. Have cadets follow along with the instruction, cleaning equipment as it is covered.

CLEANING SOLUTION

Cleaning the Coleman two-burner stove requires only a light mixture of dish soap and water and an old rag or cloth. To mix the solution, apply a few drops of dish soap in a wash bucket filled with warm water.

CLEANING

After use, the Coleman two-burner stove may be left with deposits of soot (fuel exhaust) and the remnants of food. Cleaning after use will prolong the life of the stove and delay corrosion of the metal surfaces. Parts of the Coleman two-burner stove shall be wiped clean using the cleaning solution and a rag/cloth.

The Inner and Outer Wind Baffles. The inner baffles usually become dirty and are often dirtier than the outer baffles as a result of the burning of fuel and food splashing over the pots and pans. Thoroughly wipe clean both sides of the baffles.



Figure 1 Wind Baffles

D Cds 3, 2007, Ottawa, ON: Department of National Defence

The Fuel Tank. The fuel tank shall be wiped clean. The fuel tank contains many ledges and crevices that require careful cleaning.



Figure 2 Fuel Tank

D Cds 3, 2007, Ottawa, ON: Department of National Defence

The Grate. The grate becomes dirty through direct contact with cooking utensils. Food is continuously spilled and burned onto the grate. Clean the grate of any food remnants. The grate may be stained by the heat of the flames and cannot be cleaned.

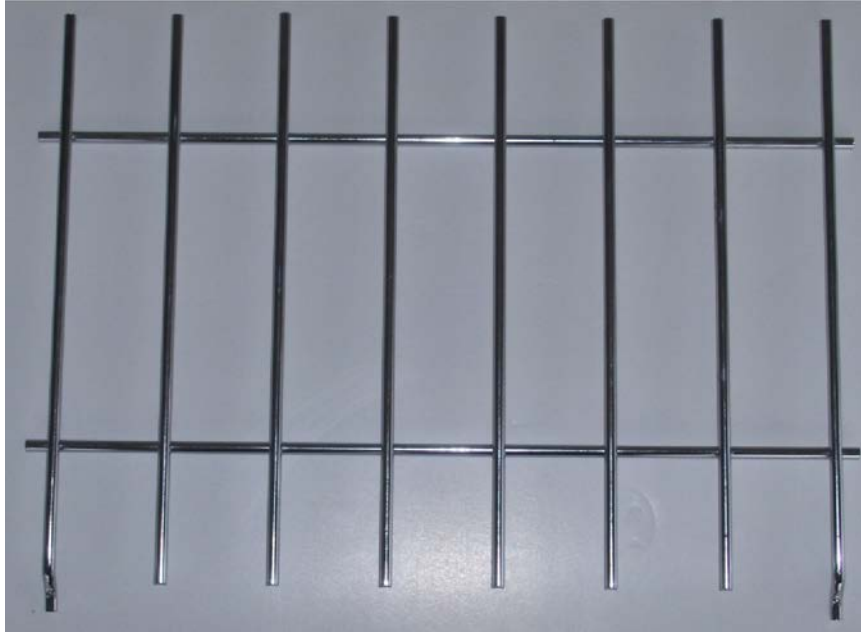


Figure 3 Grate

D Cds 3, 2007, Ottawa, ON: Department of National Defence

The Stove Box. The stove box protects the burner from dirt and debris; however, when in use, the box will collect dirt and debris. The inside of the box is subject to the spillage of food, dirt and dust. The inside and outside of the stove box shall be cleaned thoroughly because the settling of debris and dirt will speed corrosion.



Figure 4 Stove Box

D Cds 3, 2007, Ottawa, ON: Department of National Defence

INSPECTING FOR DAMAGE

After the stove has been cleaned, it must be inspected for damage. Check the following parts and report any damages:

- stove box;
- control valve assembly;
- main burner head;
- auxiliary burner head;
- pump assembly;
- wind baffles;
- stove grate; and
- fuel tank.



Damages should be recorded on a piece of coloured paper, preferably red, and attached to the damaged part. If the equipment is not suitable for use, remove it from usable equipment and report to the designated quartermaster to have the item replaced or repaired.

ENSURING THE FUEL TANK IS EMPTY PRIOR TO STORAGE

Ensure the tank is stored with no remaining pressure. To release the pressure loosen the filler cap until pressure is gone, then retighten the cap.

The fuel tank must be emptied prior to storage. Any remaining fuel should be drained into a fuel container. To drain the fuel tank, use a funnel and pour the remaining contents of the fuel tank into a fuel container. Then allow the remaining fuel to evaporate by placing the open fuel tank outside in a well ventilated area.



Drain the fuel tank outside and use a spill pan in case spillage occurs.

STORING

Store the Coleman stove in a cool, dry location away from moisture.

CONFIRMATION OF TEACHING POINT 1



The cadet's participation in cleaning the Coleman two-burner stove will serve as the confirmation of this TP. Questions have been provided if additional confirmation is required.

QUESTIONS

- Q1. What should be used as a cleaning solution?
- Q2. What areas of the wind baffles usually become dirty?
- Q3. How should damages be recorded?

ANTICIPATED ANSWERS

- A1. A mild solution of dish soap and water.
- A2. The inner baffles usually become dirty as a result of the burning of fuel and food splashing over from the pots and pans.
- A3. Damages should be recorded on a piece of coloured paper, preferably red, and attached to the damaged part.

Teaching Point 2

Explain, Demonstrate and Have the Cadets Practice Cleaning and Storing a Dual-mantle Lantern

Time: 10 min

Method: Demonstration and Performance



Provide each group with a dual-mantle lantern. Have the cadets follow along with the instruction, cleaning equipment as it is covered.

CLEANING SOLUTION

Cleaning the Coleman dual-mantle lantern requires only a light mixture of dish soap and water and an old rag/cloth. To mix the solution, apply a few drops of dish soap in a wash bucket filled with water.

CLEANING

After use, the Coleman dual-mantle lantern is left with deposits of soot (fuel exhaust) and possibly dirt or mud from being placed on the ground. Cleaning after use will prolong the life of the lantern and delay corrosion of the metal surfaces. Some parts of the Coleman dual-mantle lantern shall be wiped clean using the cleaning solution and a rag/cloth.

The Ventilator and Bail Assembly. The ventilator allows heat and exhaust to escape from the lantern. The exhaust builds up a residue on the ventilator, bail (handle) assembly and its metal parts. This residue over time becomes very greasy and dirty in appearance. Remove the ventilator and bail assembly by unscrewing the ventilator screw or uncoupling the handle and lifting clear the ventilator and bail assembly. Wipe clean the complete ventilator and bail assembly using the cleaning solution and a rag/cloth.

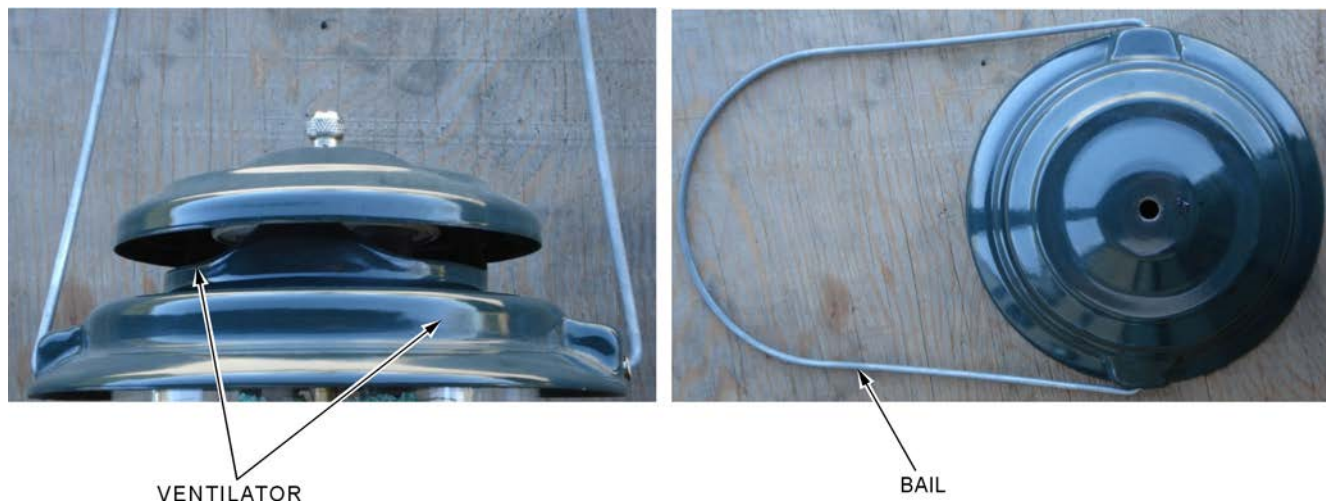


Figure 5 Ventilator and Bail Assembly

D Cdts 3, 2007, Ottawa, ON: Department of National Defence

The Globe. The globe, which protects the mantles, is made of glass. This glass becomes dirty during use. It also becomes dirty from bugs, dirt and dust that constantly come in contact with the glass. The glass becomes smudged reducing the amount of light that is emitted from the lantern. Remove the globe from the lantern, carefully lifting it over the mantles. Clean the globe using the cleaning solution and a rag/cloth.

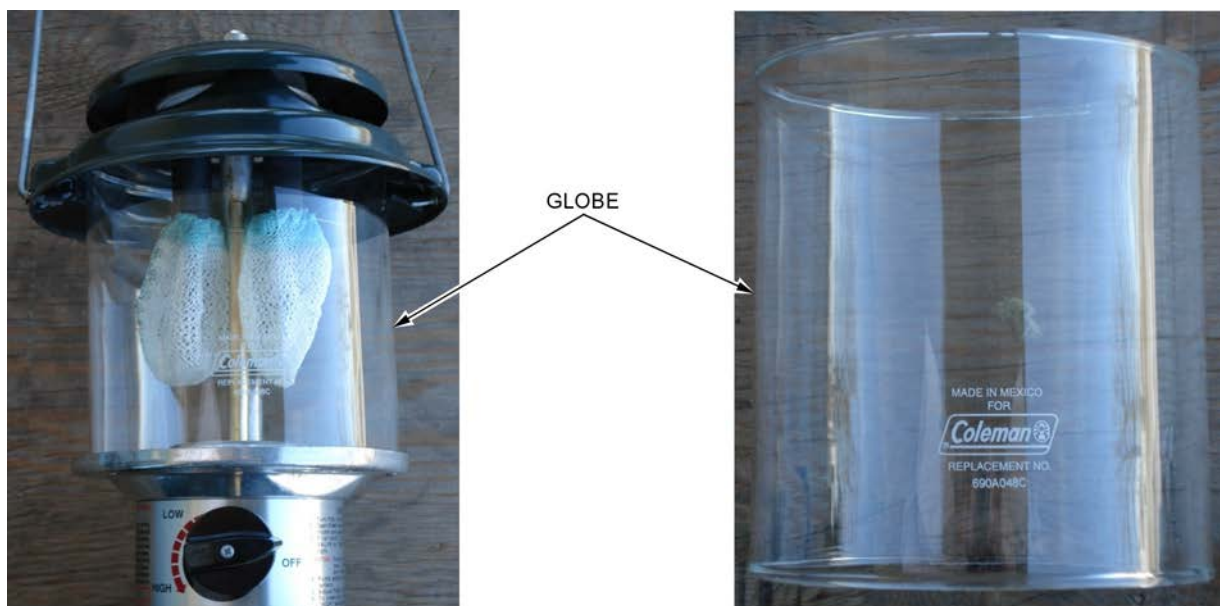


Figure 6 Globe

D Cdts 3, 2007, Ottawa, ON: Department of National Defence

The Fuel Tank. The fuel tank is the reservoir that stores fuel, otherwise known as the font. The fuel tank is used to rest the lantern on flat surfaces, whether it be the ground or a table. This area collects little residue from the exhaust of the lantern; however, it is exposed to moisture and dirt. Cleaning the outside of fuel tank with the cleaning solution is important to slow the corrosion of the metal.




Figure 7 Fuel Tank

D Cdts 3, 2007, Ottawa, ON: Department of National Defence

INSPECTING FOR DAMAGE

After the lantern has been cleaned, it must be inspected for damage. Check the following parts and report any damages:

- ventilator;
- mantle;
- bail;
- globe;
- filler cap;
- control knob;
- fuel tank; and
- pump.



Damages should be recorded on a piece of coloured paper, preferably red, and attached to the damaged part. If the equipment is not suitable for use, remove from usable equipment and report to the designated quartermaster to have the item replaced or repaired.

ENSURING THE FUEL TANK IS EMPTY PRIOR TO STORAGE

Ensure the fuel tank is stored with no remaining pressure. To release the pressure, loosen the filler cap until the pressure is gone, then retighten the cap.

The fuel tank must be emptied prior to storage. Any remaining fuel should be drained into a fuel container. To drain the fuel tank, use a funnel and pour the remaining contents of the fuel tank into a fuel container.



Drain the fuel tank outside and use a spill pan in case spillage occurs.

STORING

Store the Coleman lantern in a cool, dry location away from moisture.

CONFIRMATION OF TEACHING POINT 2



The cadets' participation in cleaning the lantern will serve as the confirmation of this TP. Questions have been provided if additional confirmation is required.

QUESTIONS

- Q1. How does the globe become dirty?
- Q2. What causes the ventilator to become dirty?
- Q3. What parts should be checked for damage?

ANTICIPATED ANSWERS

- A1. The globe becomes dirty from bugs, dirt and dust that constantly come in contact with the glass.
- A2. The ventilator becomes dirty from the exhaust. The exhaust builds up a residue on the ventilator, bail (handle) assembly and its metal parts. This residue over time becomes very greasy and dirty in appearance.
- A3. The following parts should be checked for damage:
 - ventilator;
 - mantle;
 - bail;
 - globe;
 - filler cap;
 - control knob;
 - fuel tank; and
 - pump.

Teaching Point 3**Explain, Demonstrate and Have the Cadets Practice
Cleaning and Storing a Pot Set**

Time: 10 min

Method: Demonstration and Performance



Provide each group with a pot set. Have cadets follow along with the instruction, cleaning equipment as it is covered.

CLEANING SOLUTION

Cleaning a pot requires only a light mixture of dish soap and water and an old rag/cloth. To mix the solution, apply a few drops of dish soap in a wash bucket filled with water.

CLEANING

After use, the pot set may be left with deposits of food, soot from burning flames and possibly dirt or mud from being placed on the ground. Cleaning the inner and outer walls after use will prolong the life of the pot set and keep it sanitary.

DRYING

Once all parts have been washed it is important to dry the set. To dry the set, air dry or use a dry cloth to absorb the remaining moisture. Storing a wet pot set can be dangerous and unsanitary. A pot set that is stored wet may eventually become mouldy. This may result in someone becoming sick.



Figure 8 Pot Set

D Cdts 3, 2007, Ottawa, ON: Department of National Defence

INSPECTING FOR DAMAGE

After the pot set has been cleaned and dried it must be inspected for damage. Check the following parts and report any damages:

- pot walls;
- handle;

- handle hinge;
- cover; and
- additional smaller pots, if included.



Damages should be recorded on a piece of coloured paper, preferably red, and attached to the damaged part. If the unit is not suitable for use, remove from usable equipment and report to the designated quartermaster to have the item replaced or repaired.

STORING

Store the pot set in a cool dry, location away from moisture.

CONFIRMATION OF TEACHING POINT 3



The cadets' participation in cleaning the pot set will serve as the confirmation of this TP. Questions have been provided if additional confirmation is required.

QUESTIONS

- Q1. What parts of the pot must be cleaned?
- Q2. Why should a pot set be dried?
- Q3. What parts of a pot set must be checked for damage?

ANTICIPATED ANSWERS

- A1. The inner and outer walls and the cover must be cleaned.
- A2. A pot set that is not dried and is stored wet may become mouldy and unsanitary to use for cooking.
- A3. The following parts should be checked for damage:
- pot walls;
 - handle;
 - handle hinge;
 - cover; and
 - additional smaller pots, if included.

Teaching Point 4**Explain, Demonstrate and Have the Cadets Practice
Cleaning and Storing the Following Field Tools**

Time: 10 min

Method: Demonstration and Performance



Provide each group with field tools. Have cadets follow along with the instruction, cleaning equipment as it is covered.

AXE**Washing and Drying**

Cleaning an axe with a cleaning solution is only required when the axe is noticeably covered in dirt or clay. If the axe must be washed, ensure to thoroughly dry the surfaces as left over moisture may rust the axe head and degrade the wooden handle.

Applying Storage Oil

To avoid rusting, rub a few drops of oil on the axe head. It will reduce the chances of corrosion to the axe blade. Oil type is not important.

The axe handle should be rubbed with linseed oil. Linseed oil helps wood retain its natural moisture content which retards cracking, chipping, and shrinking. Linseed oil also repels water.



To keep the handle well oiled drill a one quarter inch diameter hole three inches into the butt of the handle. Fill with linseed oil and plug the hole with a wood stopper.

Inspecting for Damage

After the axe has been cleaned and oiled it must be inspected for damage.

Handle. The handle should be inspected for chipping, cracks or splits that may weaken the wood of the handle. Look around the area where the head of the axe and the handle meet. It is common to find splits and cracks here.

Axe Head. The axe head should be checked to ensure it is tight and does not wobble or move. Check the blade for any dents or chips and feel the sharpness of the blade by gently rubbing the thumb across the blade.



Damages should be recorded on a piece of coloured paper, preferably red, and attached to the damaged part. If the unit is not suitable for use, remove from usable equipment and report to the designated quartermaster to have the item replaced or repaired.

Storing

Store the axe in a cool, dry location away from moisture.



Figure 9 Single-bit Axe

D Cds 3, 2007, Ottawa, ON: Department of National Defence

BOW SAW

Washing and Drying

Cleaning a saw with a cleaning solution is only required when the saw is noticeably covered in dirt or clay. If the saw must be washed, ensure to thoroughly dry the surfaces as left over moisture may rust the saw handle and blade.

Applying Storage Oil

To avoid rusting, put a few drops of oil on the blade. It will reduce the chances of corrosion to the saw blade. Oil type is not important. If there is a buildup of tree sap on the blade use kerosene to remove the deposits.

Inspecting for Damage

After the saw has been cleaned and oiled it must be inspected for damage.

Blade. Inspect the blade for dull or missing teeth and if it has lost shape. If any of these damages exist, the blade must be replaced.

Handles or “Cheeks”. Inspect the handles to ensure they are still in good repair. Ensure the metal has not become fatigued (weak in areas) or no major dents are apparent that may weaken the saw.

Frame. Much like the handles, inspect the frame for any metal fatigue or dents that may weaken the saw.



Damages should be recorded on a piece of coloured paper, preferably red, and attached to the damaged part. If the equipment is not suitable for use, remove from usable equipment and have the item replaced or repaired.

Storing

Store the bow saw in a cool, dry location away from moisture.



Figure 10 Bow Saw

D Cdts 3, 2007, Ottawa, ON: Department of National Defence

CONFIRMATION OF TEACHING POINT 4



The cadets' participation in cleaning field tools will serve as the confirmation of this TP. Questions have been provided if additional confirmation is required.

QUESTIONS

- Q1. What should be used to remove a buildup of tree sap on the blade?
- Q2. When inspecting for damage to the blade, what should a person look for?
- Q3. What should be placed on the blade to prevent rusting or corrosion?

ANTICIPATED ANSWERS

- A1. Kerosene is to be used when removing tree sap from the blade.
- A2. Inspect the blade for dull or missing teeth and if it has lost its shape.
- A3. A light coating of any type of oil will prevent rusting or corrosion of the metal blade.

Teaching Point 5**Explain, Demonstrate and Have the Cadets Practice
Cleaning and Storing Groundsheets**

Time: 10 min

Method: Demonstration and Performance



Provide each group with a groundsheet. Have cadets follow along with the instruction, cleaning and folding the groundsheet as it is covered.

WASHING AND DRYING

Cleaning a groundsheet is only required when it is noticeably covered in dirt or clay. If the groundsheet must be washed, use only water. Any type of cleaning solution will remove the waterproofing elements of the groundsheet. Ensure to thoroughly dry the surfaces, as left over moisture may break down and weaken the groundsheet.

FOLDING

To fold the groundsheet complete the following steps:

1. Ensure the groundsheet is completely dry.
2. Lay the groundsheet out, with the inside facing up (Step 1, Figure 11).
3. Fold the ends in to make a rectangle (Step 2, Figure 11).
4. Fold in half by bringing the right side to the left side (Step 3, Figure 11).
5. Fold the ends to the centre – right end to the centre, left end to the centre (Step 4, Figure 11).
6. Fold in half bringing right side to the left side (Step 5, Figure 11).
7. If the storage bin is smaller make more folds following the same pattern to reach the desired size for storage.



STEP 1



STEP 2



STEP 3

Figure 11 (Sheet 1 of 2) Folding a Groundsheet
D Cds 3, 2007, Ottawa, ON: Department of National Defence



STEP 4



STEP 5

Figure 11 (Sheet 2 of 2) Folding a Groundsheet
D Cmts 3, 2007, Ottawa, ON: Department of National Defence

STORING

The groundsheet should be stored in a cool, dry location out of direct sunlight. Storage bins or large plastic containers work well to organize and store groundsheets.

CONFIRMATION OF TEACHING POINT 5



The cadets' participation in folding a groundsheet will serve as the confirmation of this TP. Questions have been provided if additional confirmation is required.

QUESTIONS

- Q1. What should be used to clean a groundsheet?
- Q2. What would a cleaning solution do to a groundsheet?
- Q3. Where should a groundsheet be stored?

ANTICIPATED ANSWERS

- A1. Water should be used to clean a groundsheet.
- A2. A cleaning solution may damage or remove the waterproofing of the groundsheet.
- A3. A groundsheet should be stored in a cool dry location out of direct sunlight.

END OF LESSON CONFIRMATION

The cadets' participation in cleaning and inspecting the equipment will serve as the confirmation of this lesson.

CONCLUSION

HOMEWORK/READING/PRACTICE

N/A.

METHOD OF EVALUATION

N/A.

CLOSING STATEMENT

The ability to maintain section equipment after use in the field will prolong its life. Allowing cadets to clean and maintain section equipment will develop a sense of ownership, ensure the items are well cared for and will ensure they last for others to use.

INSTRUCTOR NOTES/REMARKS

N/A.

REFERENCES

C0-111 ISBN 978-0-9740820-2-8) Tawrell, P. (2006). *Camping and Wilderness Survival: The Ultimate Outdoors Book* (2nd ed.). Lebanon, NH: Leonard Paul Tawrell.

THIS PAGE INTENTIONALLY LEFT BLANK



ROYAL CANADIAN ARMY CADETS

RED STAR

INSTRUCTIONAL GUIDE



SECTION 10

EO C221.01 – PARTICIPATE IN A DISCUSSION ON CANADA'S WILDERNESS CONSERVATION EFFORTS

Total Time:	60 min
-------------	--------

PREPARATION

PRE-LESSON INSTRUCTIONS

Resources needed for the delivery of this lesson are listed in the lesson specification located in A-CR-CCP-702/PG-001, Chapter 4. Specific uses for said resources are identified throughout the Instructional Guide within the TP for which they are required.

Review the lesson content and become familiar with the material prior to delivering the lesson.

PRE-LESSON ASSIGNMENT

N/A.

APPROACH

An interactive lecture was chosen for TP1, TP2, and TP4 to introduce the cadets to wilderness conservation and to generate interest.

An in-class activity was chosen for TP3 as it is an interactive way to provoke thought and stimulate interest among cadets.

INTRODUCTION

REVIEW

N/A.

OBJECTIVES

By the end of this lesson the cadet shall have developed an appreciation for Canada's wilderness conservation efforts.

IMPORTANCE

It is important for cadets to appreciate the wilderness environment as well as understand the impact they have on it. The environment is very fragile and each cadet should have respect for the land we share. As Army Cadets, there is a need to contribute to efforts which help keep the natural environment's integrity.

Teaching Point 1**Define and Explain Environmental Terms**

Time: 10 min

Method: Interactive Lecture



Explain the following terms.

ENVIRONMENTAL TERMS

Conservation. Conservation is defined as using natural resources (e.g. soil, water, minerals, wildlife, and sunlight) in a way that ensures continued availability for future generations. It includes the preservation, maintenance, usage, restoration, and enhancement of the environment.

Land Ethic. Land ethic is respecting, valuing, and having concern for the natural world.

Ecosystem. An ecosystem is the interaction of living organisms and their environment. Ecosystems include:

- **Abiotic Components.** Physical elements such as water and rocks.
- **Biodiversity.** A composition of communities which have different species. For example, species found in a rainforest will differ from species found in the tundra.
- **Ecosystem Processes.** The engines that make ecosystems work, such as fires, floods, and predation (animals preying on other animals).

Ecological Integrity. Ecosystems have integrity when all components (abiotic, biodiversity, and ecosystem processes) are functioning together. People should enjoy parks without damaging these components.

Natural Resources Canada. Natural Resources Canada (NRCan) is responsible for ensuring proper development of Canada's natural resources, including energy, forests, minerals, and metals. They maintain an up-to-date knowledge base of Canadian land masses and resources.

NRCan is responsible for developing policies and programs to enhance the contribution of the natural resource sector to the economy and to improve the quality of life for all Canadians.

Provincial and National Parks. Provincial and national parks are owned by all Canadians. They are protected from most human development and pollution. The aim of these parks is to promote enjoyment by the public while conserving and enhancing the natural beauty, wildlife, and cultural heritage they contain. These parks are protected by government laws.

The mandate of national parks is to protect lands and waters that represent Canada's natural coast to coast diversity, in a way that restores or maintains ecological integrity, and in a way that allows for visitor activities and appreciation.

Crown Land. Any land that is owned by the federal or provincial government is crown land. Control and authority is placed on the Crown. The amount of crown land varies from province to province. National parks, provincial parks, native reserves, federal military bases, and provincial forests are all various forms of crown land.

Protected Areas. To ensure natural features are safe, areas of land are declared protected. Once declared protected, these areas are subject to numerous laws which help safeguard its interests. There are many protected areas across Canada, such as the Nahanni National Park Reserve of Canada, located in the Northwest Territories.

CONFIRMATION OF TEACHING POINT 1

QUESTIONS

- Q1. What is conservation?
- Q2. What are the three components of an ecosystem?
- Q3. What is a protected area?

ANTICIPATED ANSWERS

- A1. Conservation is defined as using natural resources (e.g. soil, water, minerals, wildlife, sunlight) in a way that ensures continued availability for future generations. It includes the preservation, maintenance, usage, restoration, and enhancement of the environment.
- A2. The three components of an ecosystem are abiotic components, biodiversity, and ecosystem processes.
- A3. A protected area is an area of land that has been declared protected.

Teaching Point 2

Discuss Human Impact on Park Environments

Time: 15 min

Method: Interactive Lecture



There are many ways cadets can contribute to minimizing the level of human impact on park environments. Though these points are tailored to Parks Canada and national parks, they should be considered for any bivouac site used by cadets.

ECOSYSTEM MANAGEMENT

By working closely with other land management agencies, Parks Canada demonstrates leadership in their goal to develop a better understanding of the relationship between existing land use practices and their effects on the natural environment.

It involves an understanding and a partnership among all those whose activities influence the ecological integrity of the park. For example, a cadet corps holding a weekend bivouac FTX may put strain on the environment through daily activities such as setting up shelters, constructing and lighting fires, and disposing of wastes. Other agencies and people also have an impact on this park ecology.

The concept of partnerships is also important since universities, conservation organizations, and the private sector have a lot to contribute towards research and environmental monitoring initiatives within national parks.

SUSTAINABLE DEVELOPMENT

Sustainable development involves meeting the needs of the present without compromising the needs of future generations. It is a way of thinking and acting. It is also a way of ensuring that social, economic, and environmental considerations are integrated into our decisions and our actions. Choices made now will affect choices that people can make for years to come.

The Government of Canada submits a sustainable development strategy (SDS) to Parliament every three years. Once this is approved, Parks Canada develops their SDS which outlines how they will integrate the principles into their policies, programs, legislation, and operations.



Sustainable development strategies are developed every three years and can be accessed by searching “sustainable development strategy” in the Parks Canada or Environment Canada Website.

ENVIRONMENT CANADA’S PROTECTED AREAS

The purpose of Environment Canada’s protected areas is to preserve rich and diverse populations. The Canadian Wildlife Service (CWS) is a part of Environment Canada. CWS is responsible for the protection and management of migratory birds and nationally significant habitats and endangered species. They also work on other wildlife issues of national and international importance, as they arise.

CWS works with many groups to ensure that areas are protected. There are approximately 11.8 million hectares of protected wildlife habitat – an area more than twice the size of Nova Scotia.

Components of this network include:

- National Wildlife Areas (NWAs),
- Migratory Bird Sanctuaries (MBSs), and
- Marine Wildlife Areas (MWAs).

Most protected areas permit public access and some offer visitor facilities, activities, and services. There may be exhibits, trails, brochures, and viewing stands to help visitors understand their surroundings. Canadian Wildlife Services has prohibited visitation to some protected areas during critical periods such as nesting and moulting (shedding feathers or hair).



To find out more information about Environment Canada’s protected areas, consult the following Websites:

- <http://www.cws-scf.ec.gc.ca>, or
- <http://www.hww.ca/hww2.asp?cid=4&id=231>.

LOCAL, REGIONAL, AND GLOBAL CONCERNS

Movement of Exotic Species

Exotic species are also commonly known as invasive species and refer to plants, animals, fungi, or other organisms that have been accidentally or purposefully introduced to an area outside of their origin.

Introductions can be accidental or intentional. The results of these introductions can vary from damaging the habitat to having no effect. A species may be introduced because it appears to be beneficial for the environment or through planting impure seeds. Some species may appear after disasters such as forest fires. Humans may carry some of these species when travelling. Species have been found on vehicles and clothing. This is normally accidental.

Though the majority of introduced plant species do not pose ecological or economic problems, some have become quite harmful in their new habitat. For an introduced species to become an invader, it must arrive, survive, and thrive.



An invasive species: The Zebra Mussel

The zebra mussel, which originated in eastern Europe, is a freshwater mollusc that was accidentally introduced to the Great Lakes. It was discharged in water from ship's ballast tanks in 1986, and has flourished ever since. After being in a favourable environment for about five years, it can reach densities of hundreds of thousands per square metre.

The zebra mussel is a nuisance species and brings with it many concerns. It blocks conduits (water intakes, pipelines, tunnels), corrodes ship hulls, covers wrecks, causes loss of habitat, and changes the performance of ecosystems. There have been a few solutions tried, which have not been very effective. The cost of the invasion can cost millions of dollars each year, mainly for cleaning and control measures.

Air and Water Pollution

Air pollution is a huge environmental concern. The quality of air is an important factor in the quality of life. It is generated by many sources, such as the burning of fossil fuels from industries, transportation, and heating.

Water sources such as lakes, rivers, streams, and runoffs become polluted when feces come into contact with the water. As a rule, a person should be at least 60 m from water before defecating. Animal feces will also pollute water sources.

Greenhouse Gas Emissions

(Adapted from *The Climate is Changing our National Parks*, Parks Canada, Government of Canada).

The Earth's climate changes through natural processes, but also as a result of greenhouse gas (GHG) emissions.

There has been an increase in global temperature over the last 100 years. The effects of climate change are evident on a local to a global scale. Sea levels are rising, polar ice is melting and weather is becoming less predictable.

Parks Canada is trying to reduce the GHG impacts of its operations and activities, by:

- reducing the size, fuel use, and GHG emissions of its passenger cars and light trucks;
- improving the energy-efficiency of its buildings and facilities; and
- increasing the use of renewable energy technologies.

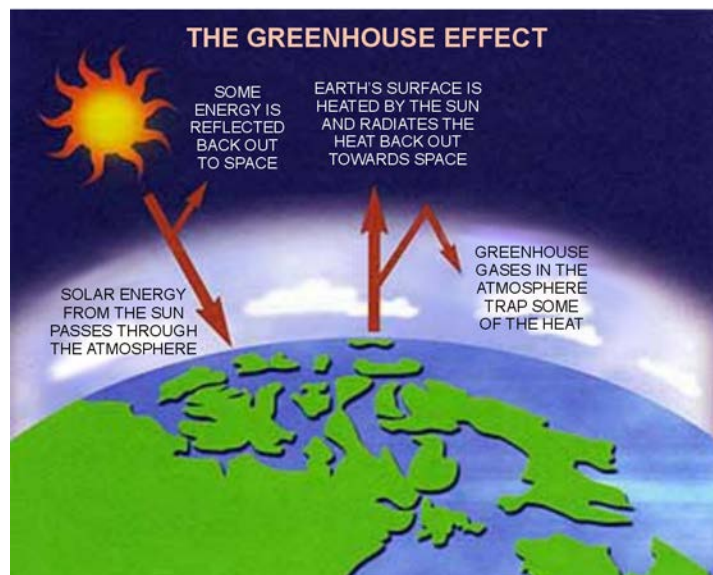


Figure 1 The Greenhouse Effect

Parks Canada, 2007, The Climate is Changing our National Parks. Copyright 2007 by Government of Canada. Retrieved 21 March 2007, from http://www.pc.gc.ca/docs/v-g/ie-ei/cc/climate_e.asp

Solid Waste Management

Everything carried into a site should be carried out. Park communities are no exception. Collectively, park residences and commercial establishments such as restaurants and hotels generate huge volumes of garbage and food waste.

Bears are a huge concern directly related to waste management. Bear-proof management of garbage is essential for the safety of people and the protection of bears and other wildlife.

Efforts to reduce, reuse, and recycle go a long way to cutting down on the amount of garbage generated. This helps reduce the consumption of valuable resources and the need for valuable land to be converted to landfills.

Wastewater Management

There will always be some leftover water, either from cooking or bathing. Never dispose of wastewater close to a stream. If it must be done, carry the water at least 60 m away from streams or lakes. Dishwater should be strained and scattered.

Water Conservation

Drinking contaminated water can be very serious. When camping, conserve whatever water you have and seek a reliable source as soon as possible.

CONFIRMATION OF TEACHING POINT 2

QUESTIONS

- Q1. A sustainable development strategy is planned and implemented how often?
- Q2. Approximately how much area is designated as protected wildlife habitats?
- Q3. What are the local, regional, and global concerns?

ANTICIPATED ANSWERS

- A1. A sustainable development strategy is planned for and implemented for three years.
- A2. Approximately 11.8 million hectares of land is declared as protected wildlife habitat.
- A3. The local, regional, and global concerns are movement of exotic species, air and water pollution, greenhouse gas emissions, solid waste management, wastewater management, and water conservation.

Teaching Point 3**Conduct a Conservation Activity**

Time: 15 min

Method: In-Class Activity

ACTIVITY**OBJECTIVE**

The objective of this activity is to brainstorm environmental efforts in which the cadets can participate to help conserve the environment.

RESOURCES

- One sheet of flipchart paper per group;
- Tape; and
- A marker.

ACTIVITY LAYOUT

N/A.

ACTIVITY INSTRUCTIONS

1. Divide the cadets into groups of a maximum of six.
2. Allow five minutes for the cadets to brainstorm, writing their responses on flipchart paper. Ask the cadets about the environmental efforts they take to help conserve the environment:
 - at home;
 - at school; and
 - in the field.



Following the principles of Leave No Trace camping is a key step in environmental conservation.

3. Tape each group's flipchart paper on a wall or in a place visible to all the cadets.
4. Discuss the points that the cadets brainstormed.



Some points may not be easy to implement; however, there are always small steps that cadets can take to ensure that people enjoy the environment for years to come.

SAFETY

N/A.

CONFIRMATION OF TEACHING POINT 3

The cadets' participation in the in-class activity will serve as the confirmation of this TP.

Teaching Point 4

Discuss the Duties of Park Conservation Officials

Time: 10 min

Method: Interactive Lecture

DUTIES OF PARK CONSERVATION OFFICIALS

Study, Monitor, and Manage Ecosystems

Park conservation officials ideally have an education in natural science or natural resource management. Their knowledge is used to collect scientific information, assess the condition of heritage resources, and monitor ecological integrity. They contribute to the preparation of management plans and play a direct role in implementing ecosystem management plans. This involves research, monitoring wildlife, capturing animals, and relocating them in rare instances when they pose a public safety hazard.

Serve as Public Spokespersons

Park conservation officials are normally well trained and educated. They are great advocates for the public. It is their duty to keep the public informed about park issues, and to deliver public safety programs. Through public education and awareness, visitors understand their role in park conservation and accident prevention.

Conduct Search and Rescue Operations

Park conservation officials are trained in first aid and rescue procedures. They respond when people are lost, injured, or endangered. Park conservation officials are responsible for providing search and rescue missions and evacuations in all kinds of terrain and environmental conditions. They implement avalanche control, fire prevention, wildlife/human safety measures, and safety inspections. Cooperation with police, provincial conservation officers, and other resource management and enforcement agencies is a vital key.

Maintain Public Safety

Park conservation officials assess the risks involved from visitor activities. This includes monitoring environmental hazards and reducing incidents through public education and awareness.

Enforce Park-Specific Laws and Regulations

Each park has a set of rules for the public to abide by. Park conservation officials ensure that these rules are being followed, and impose penalties to those who disobey.



For more information about on the duties of park officials, visit Parks Canada's Website at http://www.pc.gc.ca/agen/empl/itm3-/emp3a2_e.asp.

CONFIRMATION OF TEACHING POINT 4

QUESTIONS

- Q1. Ideally, what type of education do park officials have?
- Q2. How do park officials serve the public?
- Q3. What types of search and rescue procedures do park officials implement?

ANTICIPATED ANSWERS

- A1. Ideally, park officials are educated in natural science or natural resource management.
- A2. Park officials serve the public through public education and awareness, visitors understand the role of park officials in park conservation and accident prevention.
- A3. Park officials implement avalanche control, fire prevention, wildlife/human safety measures, and safety inspections.

END OF LESSON CONFIRMATION

QUESTIONS

- Q1. What are provincial and national parks?
- Q2. What is Parks Canada doing to try to reduce the GHG impacts of its operations and activities?
- Q3. What are the duties of park conservation officials?

ANTICIPATED ANSWERS

- A1. Provincial and national parks are owned by all Canadians. They are protected from most human development and pollution. The aim of these parks is to promote enjoyment by the public while conserving and enhancing the natural beauty, wildlife, and cultural heritage they contain. These parks are protected by government laws.
- A2. Parks Canada is trying to reduce the GHG impacts of its operations and activities by:
- reducing the size, fuel use, and GHG emissions of its passenger cars and light trucks;
 - improving the energy efficiency of its buildings and facilities; and
 - increasing the use of renewable energy technologies.
- A3. Park conservation officials are responsible for studying, monitoring and managing ecosystems, serving as public spokespersons, conducting search and rescue operations, maintaining public safety and enforcing park-specific laws and regulations.

CONCLUSION

HOMEWORK/READING/PRACTICE

N/A.

METHOD OF EVALUATION

N/A.

CLOSING STATEMENT

There are small steps that everyone can take to help conserve the environment. Protecting the environment is everyone's responsibility. When cadets are in the field, conservation should be a key factor when making decisions that could affect the environment.

INSTRUCTOR NOTES/REMARKS

This lesson may be delivered by a guest speaker. The guest speaker should present park-specific duties for which they are responsible, while stressing the importance of conserving the environment.

REFERENCES

C2-052 Parks Canada. (2007). *Parks Canada*. Retrieved 22 February 2007, from http://www.pc.gc.ca/agen/index_E.asp.

C2-053 Canadian Wildlife Service and Canadian Wildlife Federation. (2007). *Hinterland Who's Who – Environment Canada's Protected Areas Network*. Retrieved 22 February 2007, from <http://www.hww.ca/hww2.asp?cid=4&id=231>.

C2-054 Office of the Auditor General of Canada. (2007). *Office of the Auditor General of Canada*. Retrieved 22 February 2007, from <http://www.oag-bvg.gc.ca/domino/oag-bvg.nsf/html/menue.html>.

C2-066 Environment Canada. (2007). *Canada's Clean Air Act*. Retrieved 21 March 2007, from <http://www.ec.gc.ca/cleanair-airpur/default.asp?lang=En&n=6EBBF05D-1>.

C2-067 Natural Resources Canada. (2007). *About Us*. Retrieved 21 March 2007, from http://www.nrcan-nrcan.gc.ca/inter/aboutus_e.html.

C2-070 Environment Canada. (2004). *Canadian Wildlife Service: Focus on the Canadian Wildlife Service*. Retrieved 23 March 2007, from http://www.cws-scf.ec.gc.ca/focus_e.cfm#targ1.

C2-071 Environment Canada. (2002). *The Unfolding Story of the Zebra Mussel in the St. Lawrence River*. Retrieved 23 March 2007, from http://www.qc.ec.gc.ca/csl/pub/pub004_e.html.



ROYAL CANADIAN ARMY CADETS

RED STAR

INSTRUCTIONAL GUIDE



SECTION 11

EO C221.02 – CONSTRUCT FIELD AMENITIES

Total Time:

180 min

PREPARATION

PRE-LESSON INSTRUCTIONS

Resources needed for the delivery of this lesson are listed in the lesson specification located in A-CR-CCP-702/PG-001, Chapter 4. Specific uses for said resources are identified throughout the Instructional Guide within the TP for which they are required.

Review the lesson content and become familiar with the material prior to delivering the lesson.

Make copies of the handouts located at Annexes A and B for each cadet.

PRE-LESSON ASSIGNMENT

Each cadet must gather three sticks or poles approximately one inch in diameter prior to this lesson.

APPROACH

Demonstration and performance was chosen for TP1 as it allows the instructor to explain and demonstrate tying lashings while providing an opportunity for the cadets to practice tying lashings under supervision.

A practical activity was chosen for TP2 as it is an interactive way to allow the cadet to experience building field amenities in a safe, controlled environment. This activity contributes to the development of lashing skills and knowledge in a fun and challenging setting.

INTRODUCTION

REVIEW

A review of the parts of a rope, from EO M121.03 (Tie Knots and Lashings) may be required before beginning this lesson.

OBJECTIVES

By the end of this lesson the cadet shall have constructed two field amenities, using knots and lashings.

IMPORTANCE

It is important for cadets to know how to tie knots and lashings. Constructing field amenities is a fun way to incorporate knot tying to enhance a field training site.

Teaching Point 1**Explain, Demonstrate, and Allow Time for Cadets to Practice Tying Lashings**

Time: 40 min

Method: Demonstration and Performance



Distribute handouts for tying lashings.

For this skill lesson it is recommended that instruction take the following format:

1. Explain and demonstrate that complete skill while cadets observe.
2. Explain and demonstrate each step required to complete the skill. Monitor cadets as they imitate each step.
3. Monitor the cadets' performance as they practice the complete skill.

Note: Assistant instructors may be employed to monitor cadet performance.

SHEER LASHING

Also called a round lashing, it has two distinct uses. First, it creates an A-frame or set of sheer legs. Second, two or three sheer lashings can be used to bind poles together to make a longer spar (horizontal pole).

Procedure

1. Make a clove hitch around both poles.
2. Wrap the standing end around both poles, trapping the working end of the clove hitch underneath.
3. Make eight to ten more wraps around the poles.
4. Bring the rope up between the spars and make two tight turns parallel to the poles.
5. Make a clove hitch around one of the poles.
6. Ensure the lashing is tight and secure.
7. Sheer lashing opened to create a pair of sheer legs or an A-frame.

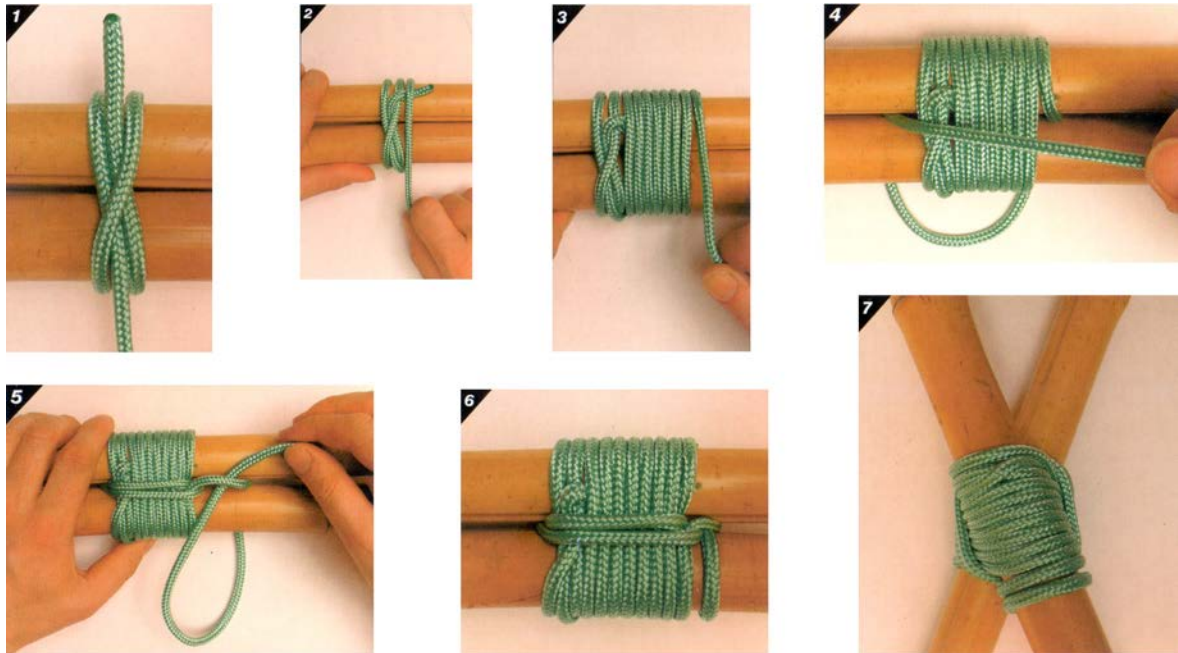


Figure 1 Sheer Lashing

Pawson, D., *Pocket Guide to Knots & Splices*, Chartwell Books, Inc. (pp. 184-185)

SQUARE LASHING

A square lashing secures two poles together at 90 degrees. The rope used to make the lashing should be considerably smaller than the size of the poles. For the lashing to be effective, each turn must be pulled as tight as possible as it is made.

Procedure

1. With the vertical pole on top of the horizontal pole, make a clove hitch. The vertical pole runs up and down, and the horizontal pole left to right.
2. Bring all of the rope around and behind the horizontal pole.
3. Tightly bring the rope over the vertical pole and back behind the horizontal pole, back to the clove hitch.
4. Continue to make three complete turns around the poles, pulling the rope tight after each turn.
5. After passing the clove hitch, tightly bring the rope to the horizontal pole from behind and start wrapping around the two poles. These wraps are called frapping turns.
6. Make two complete sets of frapping turns.
7. Make a clove hitch around the horizontal pole.
8. Ensure lashing is tight and secure.

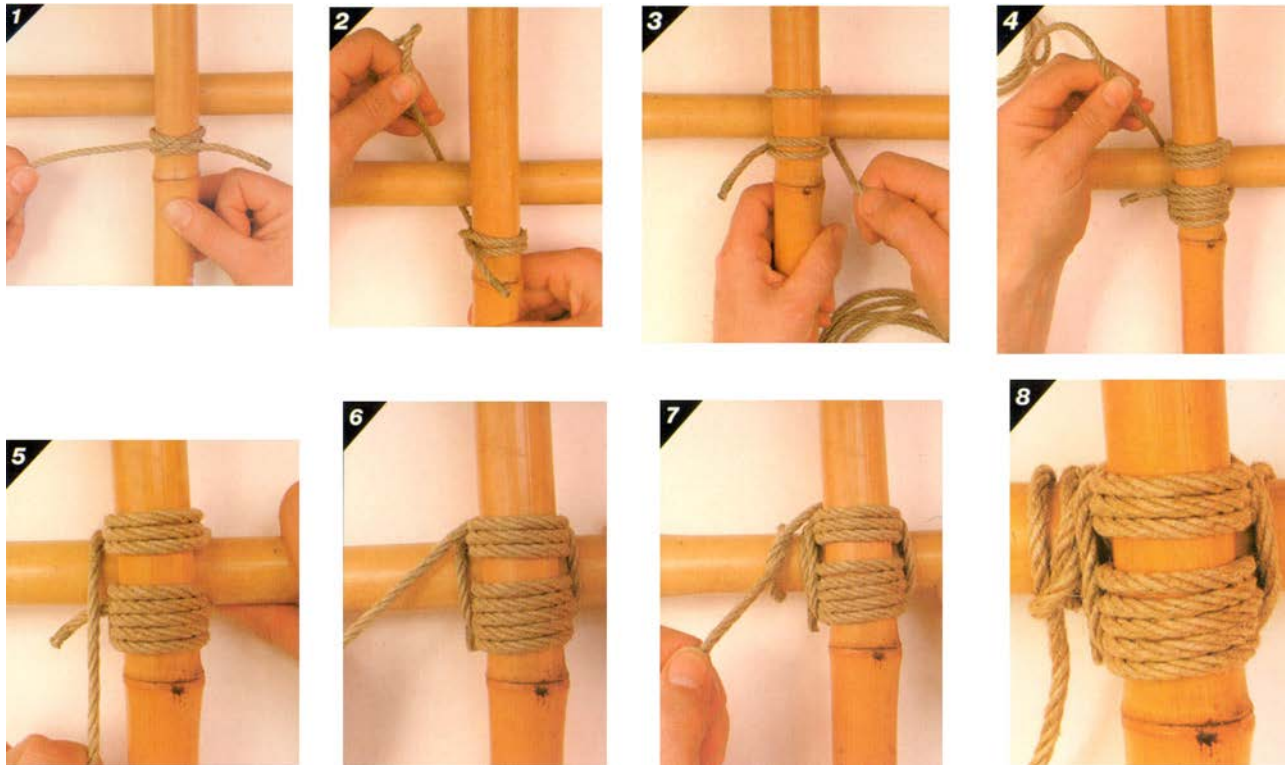


Figure 2 Square Lashing

Pawson, D., Pocket Guide to Knots & Splices, Chartwell Books, Inc. (pp. 180-181)

TIMBER HITCH



The timber hitch is included because it is required for the diagonal lashing. It should not take a great amount of time to complete.

Procedure

1. Take the standing end and wrap it around the object, then around the standing part of the rope.
2. Twist the working part around itself by wrapping it around the working end.
3. Continue making twists until the twisted rope is long enough to go around the object. Pull on the standing part to tighten the hitch.



Figure 3 Timber Hitch

Pawson, D., Pocket Guide to Knots & Splices, Chartwell Books, Inc. (p. 139)

DIAGONAL LASHING

A diagonal lashing is used at a crossing point, to prevent poles from springing apart.

Procedure

1. Make a timber hitch around the two crossed poles.
2. Make a turn around the two crossed poles, pulling the timber hitch tight.
3. Make three more complete turns in the same direction, pulling them tight.
4. Change direction by coming around one of the poles.
5. Make four full turns around the two poles at right angles to the original turns, pulling them tight.
6. Take the working end of the rope around one of the poles, making a frapping turn.
7. Make two complete frapping turns.
8. Make a clove hitch.
9. Ensure lashing is tight and secure.

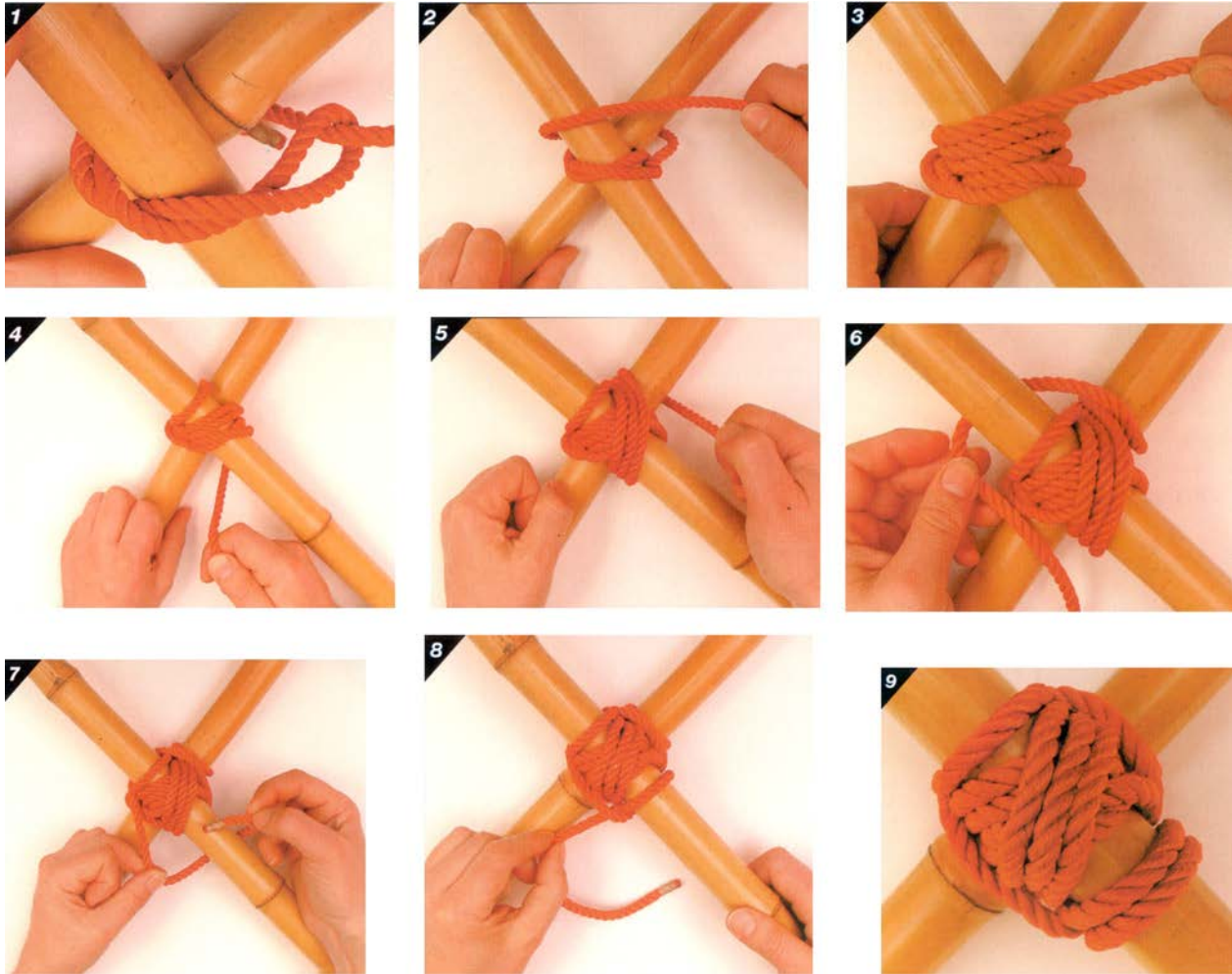



Figure 4 Diagonal Lashing

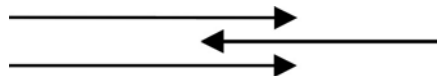
Pawson, D., Pocket Guide to Knots & Splices, Chartwell Books, Inc. (pp. 182-183)

FIGURE-OF-EIGHT LASHING

The figure-of-eight lashing is used to join three poles together, to create a tripod.



When making a figure-of-eight lashing, the poles shall be placed staggered (see diagram below).



Procedure

1. Make a clove hitch around one of the outside poles. Bring the rope under and over the other poles.
2. Go around the pole furthest away from the start and weave the rope back over and under.

3. Continue to weave the rope under and over eight times. Bring the rope up in between any two poles.
4. Pull the rope parallel to the poles and put in two frapping turns.
5. Make three frapping turns in between the remaining poles.
6. Make a clove hitch around the pole that already has a clove hitch (from the beginning) at the opposite end.
7. Open up the poles.

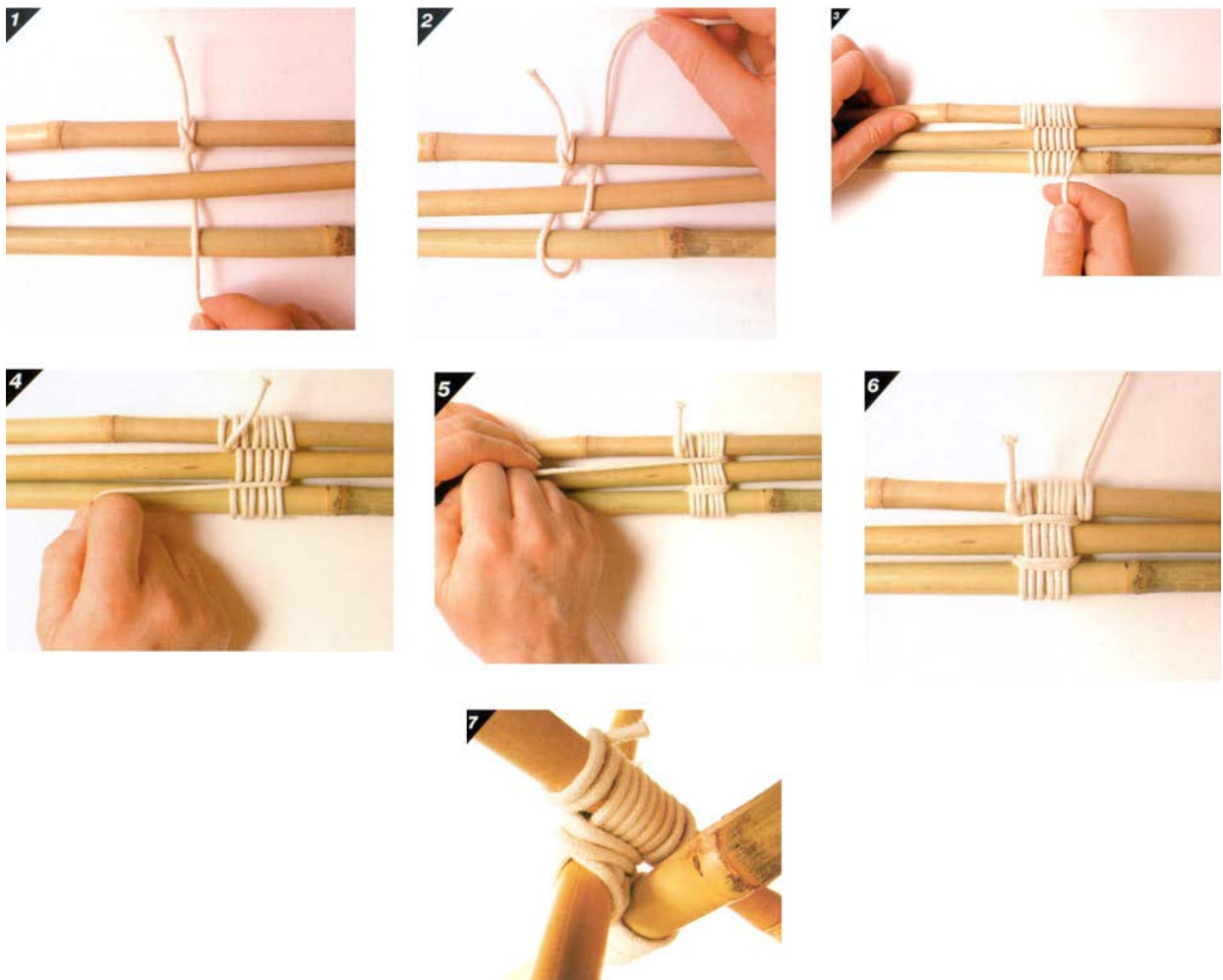


Figure 5 Figure-of-eight Lashing

Pawson, D., Pocket Guide to Knots & Splices, Chartwell Books, Inc. (pp. 187-188)

CONFIRMATION OF TEACHING POINT 1

The cadets' participation in tying the lashings will serve as the confirmation of this TP.

Teaching Point 2**Construct Field Amenities**

Time: 130 min

Method: Practical Activity

FIELD AMENITIES

Field amenities will be chosen from the following:

- a bench with back rest;
- a camp table;
- a bulletin board; and
- a podium.



Pictures and instructions of field amenities are located at Annex B.

ACTIVITY**OBJECTIVE**

The objective of this activity is to construct field amenities for a bivouac site, using the knots and lashings learned.

RESOURCES

- Rope;
- Natural resources, found in the field;
- 4 lb axe (36-inch handle);
- 24-inch bow saw; and
- Diagrams of field amenities (located at Annex B).

ACTIVITY LAYOUT

N/A.

ACTIVITY INSTRUCTIONS

1. Divide cadets into groups with a minimum of four and a maximum of eight.
2. Depending on need and availability of resources, allow cadets to choose the field amenity they will construct.
3. Distribute instructions located at Annex B. Cadets will be required to select and utilize the most effective knots and lashings to make their field amenity.

4. When amenities are completed, allow time for groups to view all constructed amenities.
5. Depending on local regulations, all material used in the construction shall be redistributed to the area once the activity is completed.

SAFETY

- Ensure cadets are employing safe tool use at all times.
- The wood chosen for the field amenities must be strong enough to hold a substantial amount of weight.
- Established boundaries shall be respected at all times.

CONFIRMATION OF TEACHING POINT 2

The cadets' participation in the activity will serve as the confirmation of this TP.

END OF LESSON CONFIRMATION

The cadets' participation in the construction of field amenities in TP2 will serve as the confirmation of this lesson.

CONCLUSION

HOMEWORK/READING/PRACTICE

N/A.

METHOD OF EVALUATION

N/A.

CLOSING STATEMENT

Field amenities will enhance any base camp. They are relatively easy to construct and are a fun way to reinforce usage of knots. They can make cadets comfortable in the field when it is a home away from home.

INSTRUCTOR NOTES/REMARKS

Natural resources found in the field, such as fallen or dead wood, are to be used for construction. Instructors are to confirm with local authorities that natural resources may be used for this activity.

If field amenities are being evaluated, they shall be judged on stability, quality of lashings, and overall appearance.

REFERENCES

C2-007 (ISBN 0-7858-1446-9) Pawson, D. (2001). *Pocket Guide to Knots and Splices*. Edison, NJ: Chartwell Books, Inc.

C2-008 (ISBN 0-00-265314-7) Wiseman, J. (1999). *The SAS Survival Handbook*. Hammersmith, London: HarperCollins Publishers.

C2-046 PioneeringProjects.org (2004). *PioneeringProjects.org*. Retrieved 20 February 2007, from <http://www.pioneeringprojects.org/projects/index.htm>.

THIS PAGE INTENTIONALLY LEFT BLANK

TYING LASHINGS

SHEER LASHING

Procedure

1. Make a clove hitch around both poles.
2. Wrap the standing end around both poles, trapping the working end of the clove hitch underneath.
3. Make eight to ten more wraps around the poles.
4. Bring the rope up between the spars and make two tight turns parallel to the poles.
5. Make a clove hitch around one of the poles.
6. Ensure the lashing is tight and secure.
7. Sheer lashing opened to create a pair of sheer legs or an A-frame.

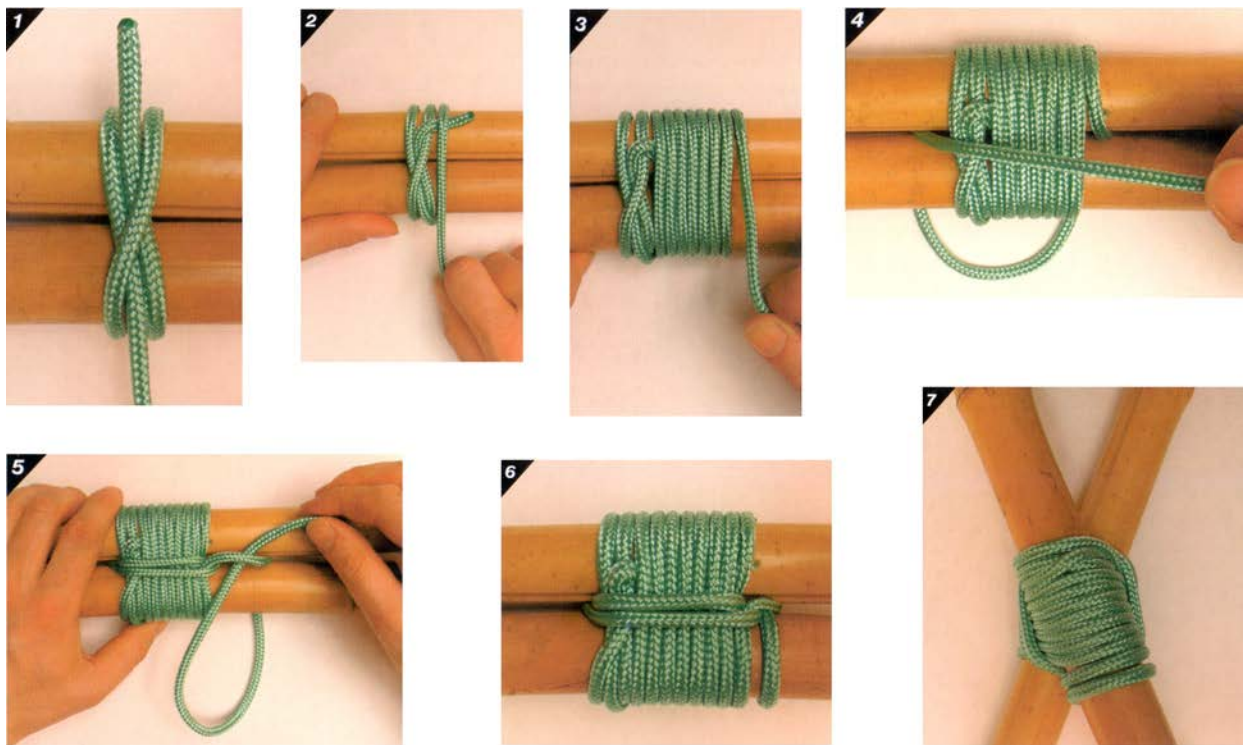


Figure A-1 Sheer Lashing

Pawson, D., Pocket Guide to Knots & Splices, Chartwell Books, Inc. (pp. 184-185)

SQUARE LASHING

Procedure

1. With the vertical pole on top of the horizontal pole, make a clove hitch. The vertical pole runs up and down, and the horizontal pole left to right.
2. Bring all of the rope around and behind the horizontal pole.
3. Tightly bring the rope over the vertical pole and back behind the horizontal pole, back to the clove hitch.
4. Continue to make three complete turns around the poles, pulling the rope tight after each turn.
5. After passing the clove hitch, tightly bring the rope to the horizontal pole from behind and start wrapping around the two poles. These wraps are called frapping turns.
6. Make two complete sets of frapping turns.
7. Make a clove hitch around the horizontal pole.
8. Ensure lashing is tight and secure.

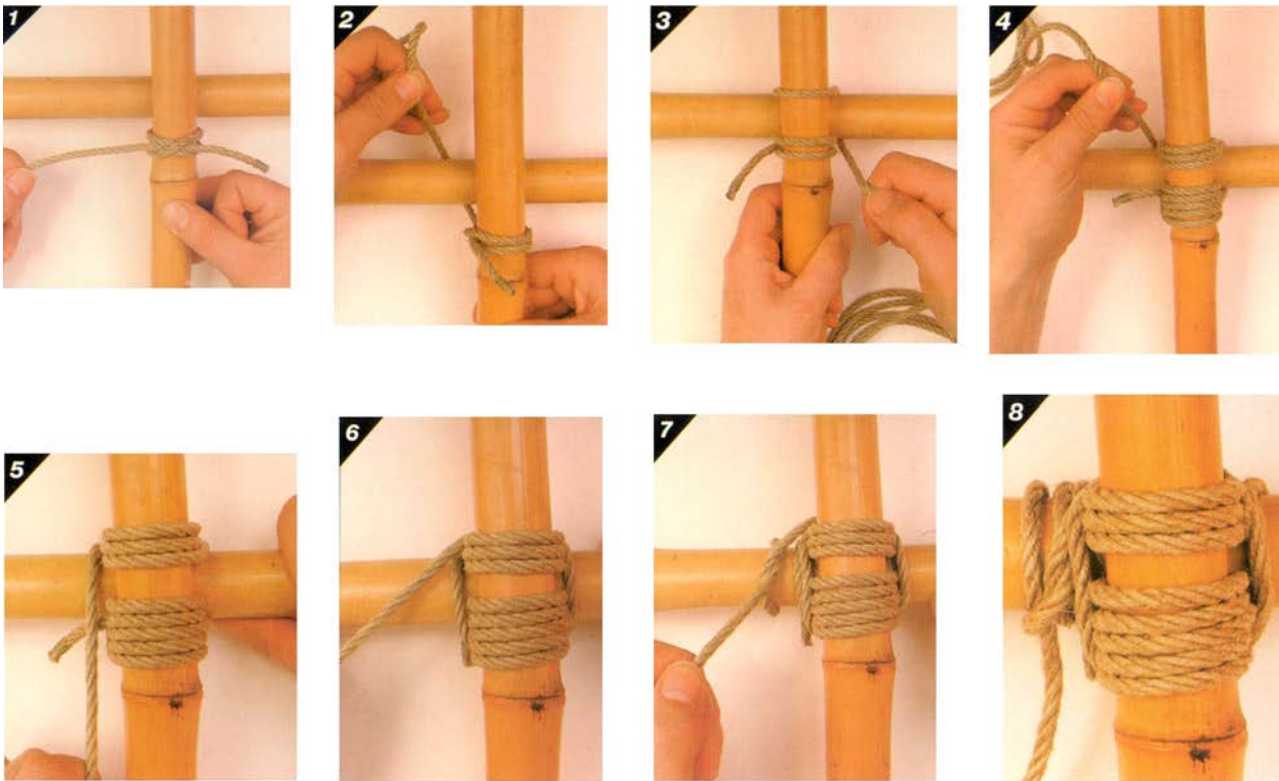


Figure A-2 Square Lashing

Pawson, D., Pocket Guide to Knots & Splices, Chartwell Books, Inc. (pp. 180-181)

DIAGONAL LASHING

Procedure

1. Make a timber hitch around the two crossed poles.
2. Make a turn around the two crossed poles, pulling the timber hitch tight.
3. Make three more complete turns in the same direction, pulling them tight.
4. Change direction by coming around one of the poles.
5. Make four full turns around the two poles at right angles to the original turns, pulling them tight.
6. Take the working end of the rope around one of the poles, making a frapping turn.
7. Make two complete frapping turns.
8. Make a clove hitch.
9. Ensure lashing is tight and secure.

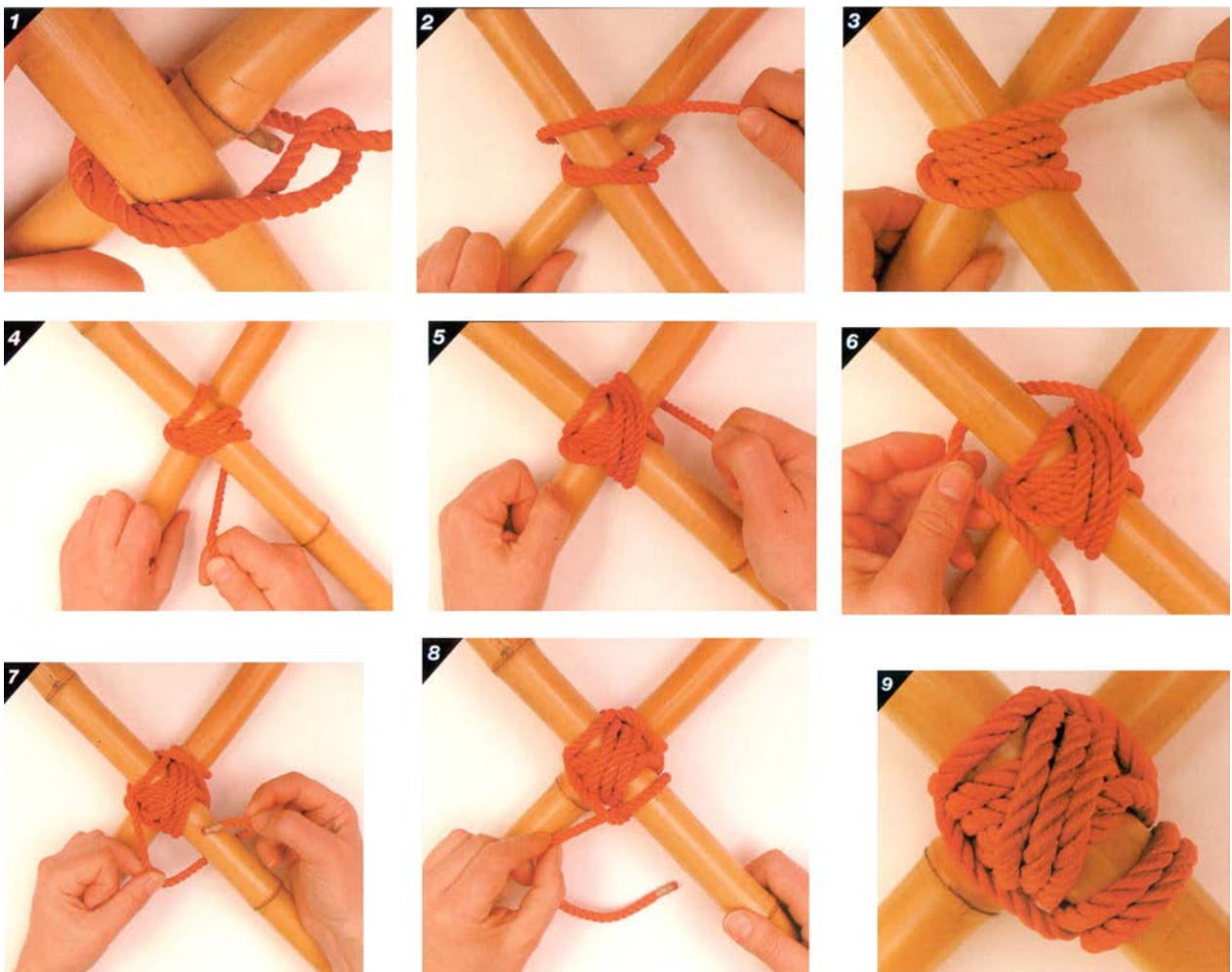


Figure A-3 Diagonal Lashing

Pawson, D., Pocket Guide to Knots & Splices, Chartwell Books, Inc. (pp. 182-183)

FIGURE-OF-EIGHT LASHING

Procedure

1. Make a clove hitch around one of the outside poles. Bring the rope under and over the other poles.
2. Go around the pole furthest away from the start and weave the rope back over and under.
3. Continue to weave the rope under and over eight times. Bring the rope up in between any two poles.
4. Pull the rope parallel to the poles and put in two frapping turns.
5. Make three frapping turns in between the remaining poles.
6. Make a clove hitch around the pole that already has a clove hitch (from the beginning) at the opposite end.
7. Open up the poles.

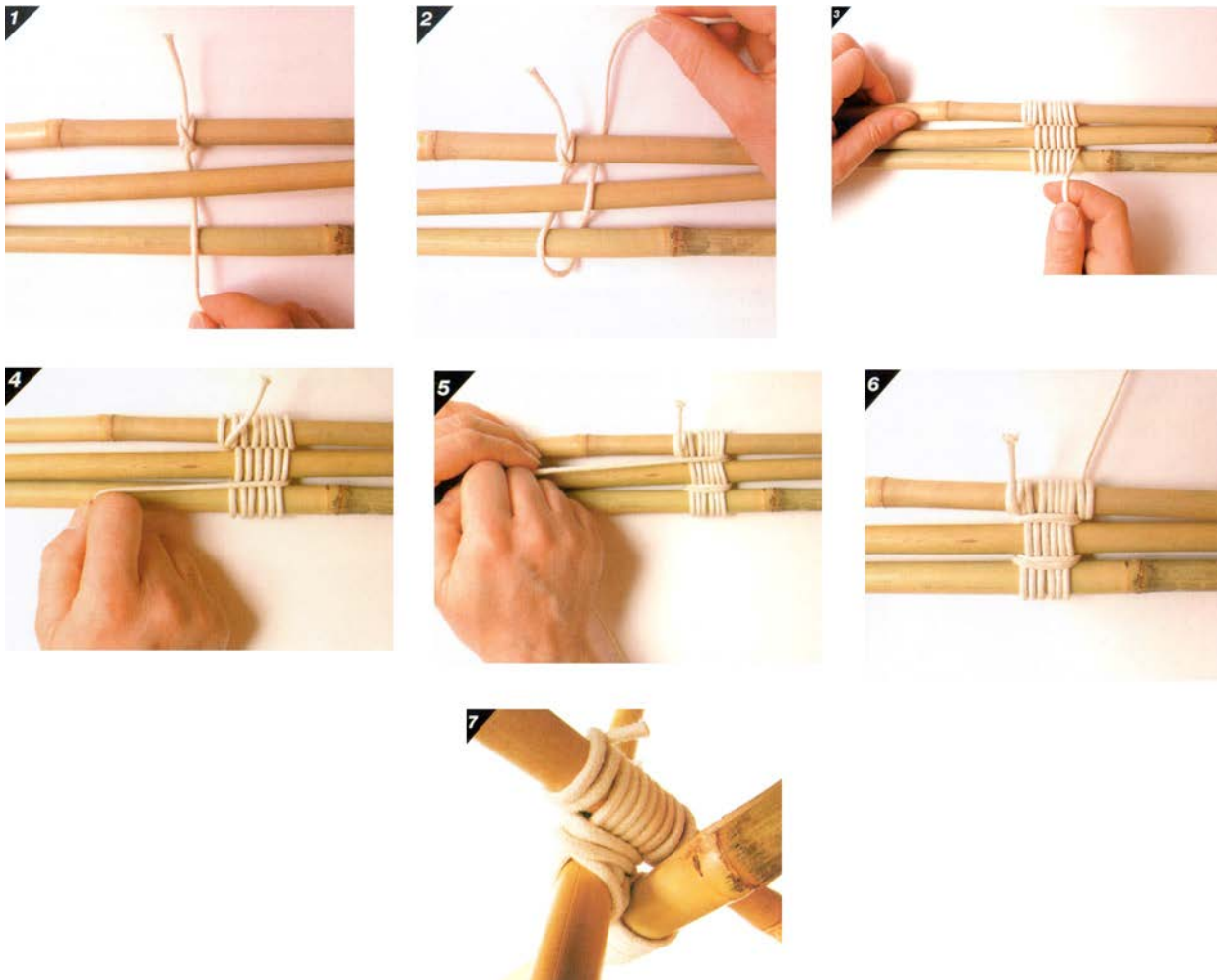


Figure A-4 Figure-of-eight Lashing

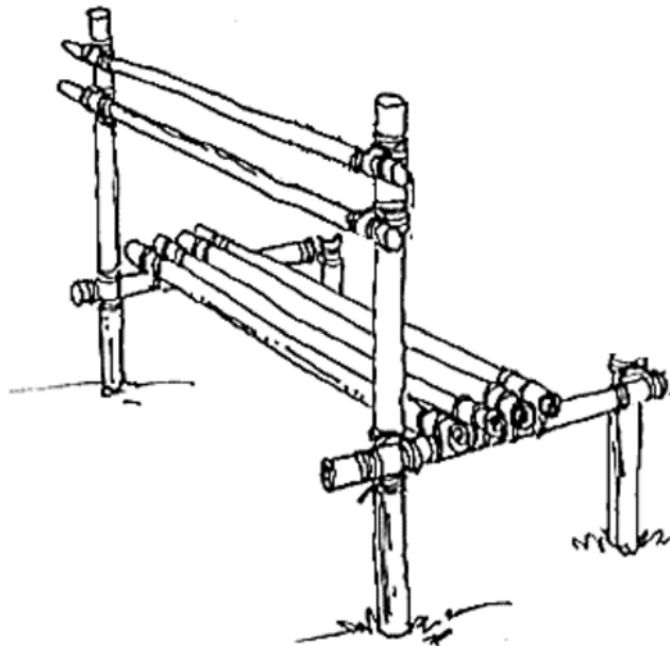
Pawson, D., Pocket Guide to Knots & Splices, Chartwell Books, Inc. (pp. 187-188)

FIELD AMENITIES

BENCH WITH BACK REST

Instructions

1. Find a large area.
2. Obtain the following resources:
 - a large quantity of rope;
 - eight round pieces of wood/logs approximately two metres each;
 - two round pieces of wood/logs approximately one metre each; and
 - two round pieces of wood/logs approximately one half metre each.
3. Begin by constructing the sitting portion of the bench by attaching four long pieces of wood to the one metre pieces, using square lashings.
4. Drive the two long and two short pieces of wood that will be used as the legs of the bench into the ground.
5. Lash the sitting portion onto the legs, using square lashings.
6. Construct the back rest using square lashings and attach it to the long legs in the ground.



BENCH WITH BACK REST

Figure B-1 Bench With Back Rest

*PioneeringProjects.org, by A. Miller, 2004, Projects, Copyright 2001 from PioneeringProjects.org.
Retrieved 20 February 2007, from <http://www.pioneeringprojects.org/projects/index.htm>*

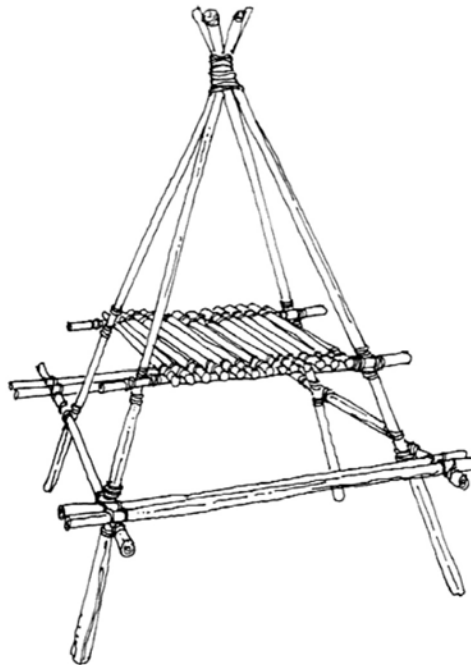
CAMP TABLE

Instructions

1. Find a large area.
2. Obtain the following resources:
 - a large quantity of rope,
 - four round pieces of wood/logs approximately three metres each;
 - six round pieces of wood/logs approximately two metres each;
 - two round pieces of wood/logs approximately one metre and a half each; and
 - fourteen round pieces of wood/logs approximately one half metre each.
3. Construct a figure-of-eight lashing around the four long pieces of wood, to make an A-frame.
4. Construct the table top, using square lashings.
5. Attach the table top portion to the long poles, using square lashings.
6. Make the sitting portion using square lashings and attach it to the long poles using square lashings.



The best lashing to use for the peak of the camp table is the figure-of-eight lashing. It must be tied using the indicated steps; however, there will be four poles used instead of three.



CAMP TABLE

Figure B-2 Camp Table

*PioneeringProjects.org, by A. Miller, 2004, Projects, Copyright 2001 from PioneeringProjects.org.
Retrieved 20 February 2007, from <http://www.pioneeringprojects.org/projects/index.htm>*

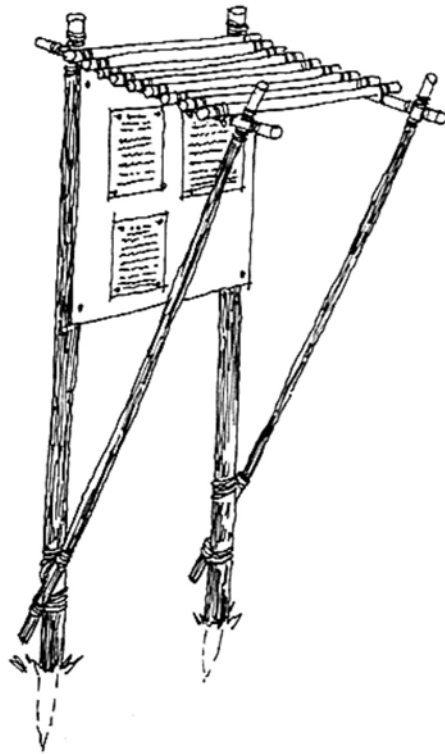
BULLETIN BOARD

Instructions

1. Find a large area.
2. Obtain the following resources:
 - a large quantity of rope;
 - two thick round pieces of wood/logs approximately two metres each;
 - two round pieces of wood/logs approximately two metres each; and
 - twelve round pieces of wood/logs approximately one metre each.
3. Construct the canopy portion of the bulletin board using square lashings.
4. Tie the ends of the thin two metre wood to the thick two metre wood with a sheer lashing.
5. Use diagonal lashings to fasten the thin two metre wood to the canopy.
6. Square lash the end of the canopy to the thick wood.
7. Drive the two thick round pieces of wood into the ground.



A flat piece of wood or a piece of bristol board can be used for the background of the bulletin board.



BULLETIN BOARD

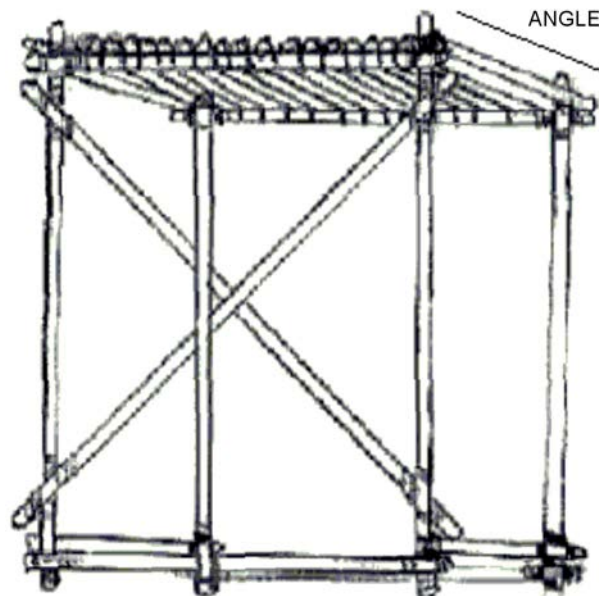
Figure B-3 Bulletin Board

*PioneeringProjects.org, by A. Miller, 2004, Projects, Copyright 2001 from PioneeringProjects.org.
Retrieved 20 February 2007, from <http://www.pioneeringprojects.org/projects/index.htm>*

PODIUM

Instructions

1. Find a large area.
2. Obtain the following resources:
 - a large quantity of rope;
 - twelve to fifteen round pieces of wood/logs approximately one half metre each; and
 - eight round pieces of wood/logs approximately one and a half metres each.
3. Construct the table portion of the podium using square lashings.
4. Construct the base of the podium using square lashings. The X portion will provide needed support and requires diagonal lashings.
5. Square lash the table portion of the podium to the base.



PODIUM

Figure B-4 Podium

*PioneeringProjects.org, by A. Miller, 2004, Projects, Copyright 2001 from PioneeringProjects.org.
Retrieved 20 February 2007, from <http://www.pioneeringprojects.org/projects/index.htm>*

THIS PAGE INTENTIONALLY LEFT BLANK



ROYAL CANADIAN ARMY CADETS

RED STAR

INSTRUCTIONAL GUIDE



SECTION 12

EO C221.03 – IDENTIFY SPECIES OF TREES

Total Time:

60 min

PREPARATION

PRE-LESSON INSTRUCTIONS

Resources needed for the delivery of this lesson are listed in the lesson specification located in A-CR-CCP-702/PG-001, Chapter 4. Specific uses for said resources are identified throughout the Instructional Guide within the TP for which they are required.

Review the lesson content and become familiar with the material prior to delivering the lesson.

Prior to this lesson, it is recommended that instructors consult local resources to identify the most common species of trees within the area.

Prior to this lesson, find an area containing as many types of trees as possible. With brightly coloured tape, mark four trees that cadets can identify. Prepare activity instructions according to the area.

Photocopy Annex A for each cadet for the activity in TP3.

For an indoor activity, photocopy Annex B to post in the classroom. Ensure all references are removed.

PRE-LESSON ASSIGNMENT

N/A.

APPROACH

An interactive lecture was chosen for TP1 and TP2 to introduce species of trees and to generate interest.

A practical activity was chosen for TP3 as it is an interactive way to identify species of trees and to confirm the cadet's comprehension of the material.

INTRODUCTION

REVIEW

N/A.

OBJECTIVES

By the end of this lesson the cadet shall identify species of trees.

IMPORTANCE

It is important for cadets to know about species of trees so they may gain a greater understanding of the ecosystem and develop an appreciation for the outdoors.

Teaching Point 1

Identify Characteristics of Deciduous Trees

Time: 20 min

Method: Interactive Lecture



There are approximately 170 species of trees in Canada.

Deciduous trees are often called broadleaved trees because they shed annually in the fall. They change colour and lose their leaves before winter. Deciduous trees may produce flowers and fruit depending on the season.

The most common deciduous trees in Canada are:

- alder;
- beech;
- birch;
- chestnut;
- elm;
- hickory;
- maple; and
- oak.



Deciduous trees account for the majority of tree species in Canada.

ENVIRONMENT

Deciduous trees are mainly found in the boreal forest. A milder climate is better for deciduous trees.



Figure 1 Map of the Forest Regions of Canada

Natural Resources Canada, 2004, The Atlas of Canada, Retrieved 29 March 2007, from http://atlas.nrca.gc.ca/site/English/learningresources/theme_modules/borealforest/forest_regions.jpg/image_view

SEEDS

Deciduous trees have seeds contained within a fruit or a flower.

LEAF ATTACHMENT

Deciduous trees are usually identified by their leaves. There are three types of leaf attachment: alternate, opposite and whorled leaves.

Alternate Leaves. They are attached to alternating nodes along the branch. There is a single leaf at each node. The alder, beech, birch, cherry, elm and oak trees all have alternate leaves.

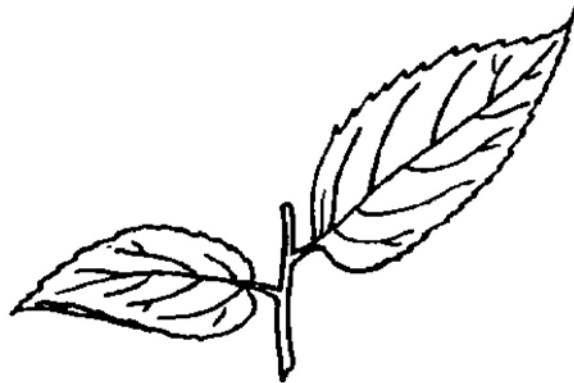


Figure 2 Alternate Leaf Arrangement

University of Kentucky, College of Agriculture - Online Publications - Forestry Publications Youth Education, 2007, Introducing Yourself to Trees, Copyright 2007 by University of Kentucky, College of Agriculture. Retrieved 22 March 2007, from <http://www.ca.uky.edu/agc/pubs/for/for65/1b.gif>

Opposite Leaves. They are attached to the branch directly opposite one another. There are two leaves at each node. The chestnut, hickory and maple trees all have opposite leaves.

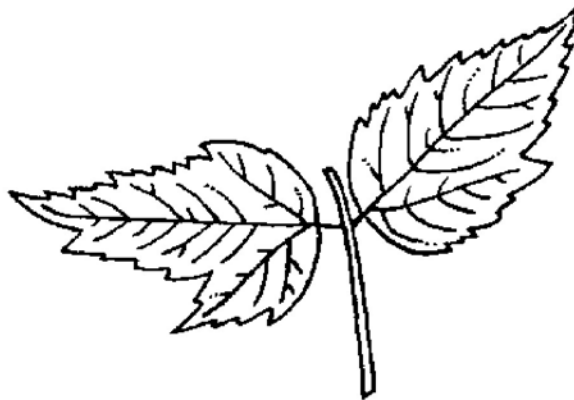


Figure 3 Opposite Leaf Arrangement

University of Kentucky, College of Agriculture - Online Publications - Forestry Publications Youth Education, 2007, Introducing Yourself to Trees, Copyright 2007 by University of Kentucky, College of Agriculture. Retrieved 22 March 2007, from <http://www.ca.uky.edu/agc/pubs/for/for65/1a.gif>

Whorled Leaves. They are attached to the tip of the twig in a circle. There are more than two leaves at each node. Fruit trees like apple and plum trees usually have whorled leaves.



Figure 4 Whorled Leaf Arrangement

University of Kentucky, College of Agriculture - Online Publications - Forestry Publications Youth Education, 2007, Introducing Yourself to Trees, Copyright 2007 by University of Kentucky, College of Agriculture. Retrieved 22 March 2007, from <http://www.ca.uky.edu/agc/pubs/for/for65/1a.gif>



Plants and trees that have whorled leaves often have opposite leaf pairs as well.

LEAF TYPE

Deciduous trees can have two types of leaves – simple and compound leaves.

Simple Leaves. Simple leaves are composed of one leaf. All types of alder, beech, birch, chestnut, elm, maple and oak trees fall under the simple leaf category.



Figure 5 Simple Leaf

Natural Resources Canada, 2002, Round Leaves, Retrieved 22 March 2007, from http://www.cfl.scf.rncan.gc.ca/imfec-idecf/hosttrees/deciduous/leaves_round.html

Compound Leaves. Compound leaves are composed of several leaflets and they make up the entire leaf. All types of hickory trees fall under this category.



Figure 6 Compound Leaf

Natural Resources Canada, 2002, Compound Leaves, Retrieved 22 March 2007, from http://www.cfl.scf.nrcan.gc.ca/imfec-idecf/hosttrees/deciduous/leaves_compound.html

BARK

Bark protects trees from the outside world, against weather elements, diseases and insects. It also keeps moisture in during dry periods.

Deciduous trees have different types of bark depending on the tree and its environment.

Red Alder Bark. The bark is thin, greenish on young trees, turning grey to whitish with age. The colour may also be ashy-gray. It is often draped with moss.



Figure 7 Red Alder Bark

Lichens of North America, 2007, Lichens and Ecosystems, Copyright 2007 for Stephen and Sylvia Sharnoff. Retrieved 30 March 2007, from <http://www.lichen.com/bigpix/aldersbare.html>

Beech Bark. The bark is smooth and has ridges. The colour can range from gray to blue-gray.



Figure 8 American Beech Bark

Ibiblio, the Public's Library and Digital Archive, 2006, Index of/botnet/angiospermbark. Retrieved 30 March 2007, from <http://www.ibiblio.org/botnet/angiospermbark/beechn.jpg>

Birch Bark. The bark is thin, white to reddish-brown, with dark horizontal slits. It peels in papery strips, exposing reddish-orange inner bark, which will gradually turn black with age.



Figure 9 Birch Bark

Richard's Notes, 2004, White Birch Bark, Copyright 2004 by Richard's Note. Retrieved 27 March 2007, from <http://www.richardsnotes.org/archives/2004/03/page/2/>



The bark of all species of birch is excellent for tinder, kindling and torches. It is full of resinous oil which blazes up and will burn in the wind.

Chestnut Bark. The bark colour may range from dark to pale brown with touches of gray. It is broken into broad, flattened scaly ridges.



Figure 10 Chestnut Bark

Bioimages, Copyright 2002 by Bioimages. Retrieved 30 March 2007, from <http://www.cas.vanderbilt.edu/bioimages/species/aehi.htm>

Elm Bark. The bark is dark gray in flat-topped ridges.



Figure 11 Elm Bark

Bioimages, Copyright 2002 by Bioimages. Retrieved 30 March 2007, from <http://www.cas.vanderbilt.edu/image/u/u/lse--brlarge16180.htm>

Hickory Bark. The bark is composed of long and shaggy rectangular pieces.



Figure 12 Hickory Bark

Firewood, Copyright 2007 by Donnan.com. Retrieved 27 March 2007, from <http://www.donnan.com/firewood.htm>

Maple Bark. The bark is scaly and creased.



Figure 13 Sugar Maple Bark

Firewood, Copyright 2007 by Donnan.com. Retrieved 27 March 2007, from <http://www.donnan.com/firewood.htm>

Oak Bark. The bark is usually greyish-black with thick grooves and scales. It is composed of vertical blocks of scaly plates.



Figure 14 Oak Bark

Firewood, Copyright 2007 by Donnan.com. Retrieved 27 March 2007, from <http://www.donnan.com/firewood.htm>

USAGE

Deciduous trees are also called hardwood. Thirty-two species of deciduous trees are used commercially. The following illustrates some of the various products made from hardwood:

- furniture (dining room tables, coffee tables, beds, bookcases, etc.);
- musical instruments (guitars, banjos, violins, drums, drumsticks, etc.);
- pencils;
- tool handles;
- ladders;
- picnic tables; and
- telephone poles.

FIREWOOD

Hardwood is slow burning, producing good steady heat but poor light.



Alder, beech, birch, chestnut, elm, hickory, maple and oak are classified under hardwood.

Maple wood ignites easily and it makes a steady flame.

CONFIRMATION OF TEACHING POINT 1**QUESTIONS**

- Q1. Why are deciduous trees called broadleaves?
- Q2. Name the three types of leaf attachment.
- Q3. Name four of the most common deciduous trees in Canada.

ANTICIPATED ANSWERS

- A1. Deciduous trees are often called broadleaves because they shed annually in the fall.
- A2. Alternate, opposite and whorled.
- A3. Alder, beech, birch, chestnut, elm, hickory, maple and oak.

Teaching Point 2**Identify Characteristics of Coniferous Trees**

Time: 20 min

Method: Interactive Lecture

Coniferous trees are collectively referred to as conifers or evergreens. They all have leaves that look like needles (pines or spruces) or scales (cedars). Coniferous trees generally have persistent foliage (leafage) consisting of needles or scales.



Persistent foliage is a characteristic of evergreen trees. It means they do not shed their leaves in the fall.

Coniferous trees are usually distinguished from one another by their bark, the number of needles in each bundle, the way the needles are arranged on the twigs, and the cone size, shape and colour.

The most common coniferous trees in Canada are:

- cedar;
- fir;
- hemlock;
- larch;
- pine;
- spruce; and
- tamarack.

ENVIRONMENT

Coniferous trees are mainly found in the northern hemisphere, in cool climates. They populate the boreal forest and the mountains.

SEEDS

Coniferous seeds are not contained in a fruit. The seeds are born on scales which are grouped together to form a cone. The cone is the reproductive structure of the coniferous tree. It consists of a central axis covered with scales that are tightly pressed together. At maturity, cones contain seeds. Cones are like flowers.



Figure 15 Cones

The Canadian Encyclopedia, 2007, Conifers, Copyright 2007 by Alberta Forest Service, Retrieved 22 March 2007, from <http://www.thecanadianencyclopedia.com/index.cfm?PgNm=TCE&Params=A1SEC818695>

NEEDLE ARRANGEMENT

There are three types of needle arrangement – single, clustered and overlapping scales.

Single Needle. The needles are not joined in a bundle. There is only one needle. Fir, hemlock and spruce trees all fall under this category.



Figure 16 Single Needle Fir

Blue Ridge Community College, 2007, Arboretum-Interactive Key, Retrieved 27 March 2007, from http://www1.brcc.edu/murray/interactive_key/key/needles/nl.htm

Clustered Needles. Clustered needles are wrapped at the base. Larch, pine and tamarack trees fall under this category.



Figure 17 Clustered Needles

Wildflowers of Prince Edwards County, 2003, White Pine, Retrieved 23 March 2007 from <http://www.pec.on.ca/wildflowers/flowers.php?id=514>

Overlapping Scales. Only trees in the cedar family have this type of needle.



Figure 18 Red Cedar Overlapping Scales

Wikipedia, 2006, Thuja Plicata. Retrieved 30 March 2007, from http://en.wikipedia.org/wiki/thuja_plicata



Canada's aboriginal people would boil six 10 cm cedar branches in a large pot of 4 litres of water to make cedar tea.

BARK

Bark protects the tree from the outside world, against weather elements, diseases and insects. It also keeps moisture in during dry periods.

Coniferous trees have different types of bark depending on the tree and its environment.

Cedar Bark. Cedar bark is grey, stringy and tears off in long strips on mature trees. It is fibrous and irregularly creased.



Figure 19 Cedar Bark

Natural Resources Canada, 2002, Conifers, Retrieved 27 March 2007, from <http://www.cfl.scf.rncan.gc.ca/imfec-idecf/hosttrees/conifers/cedar.html>

Fir Bark. Fir bark is usually covered with resin blisters. The bark generally resembles scaly plates.



Figure 20 Fir Bark

Bioimages, Copyright 2002 by Bioimages. Retrieved 27 March 2007, from <http://www.cas.vanderbilt.edu/bioimages/image/a/abfr--br11426.htm>

Hemlock Bark. Dark brown to reddish-brown, becoming thick and strongly grooved with age.



Figure 21 Hemlock Bark

Ministry of Forest and Range – Government of British Columbia, 2001, Tree Book Western Hemlock, Copyright 2001 for the Province of British Columbia. Retrieved 30 March 2007, from <http://www.for.gov.bc.ca/hfd/librarydocuments/treebook/westernhemlock.htm>

Larch Bark. Mature trees develop a thick, grooved plate-like bark with cinnamon-coloured scales.



Figure 22 Western Larch Bark

Ministry of Forest and Range – Government of British Columbia, 2001, Tree Book Western Larch, Copyright 2001 for the Province of British Columbia. Retrieved 30 March 2007, from <http://www.for.gov.bc.ca/hfd/librarydocuments/treebook/westernlarch.htm>

Pine Bark. Pine bark is usually thin, smooth, and chalky-white on young stems; as the tree gets older, the bark becomes thicker and forms narrow, brown, scaly plates.



Figure 23 Pine Bark

Bioimages, Copyright 2002 by Bioimages. Retrieved 27 March 2007, <http://www.cas.vanderbilt.edu/bioimages/image/p/pivi2-brmedium13509.htm>

Spruce Bark. Spruce bark is usually loose, scaly, and greyish-brown. It may have resin blisters.



Figure 24 Spruce Bark

St. Mary's School, 2003, Mrs. Zvonar's Tree Page, Copyright 2003 for St. Mary's School. Retrieved 27 March 2007, from http://www.stmarysschool.net/whitesprucetree_cb.html

Tamarack Bark. Tamarack bark is usually red-brown, thin, and scaly.



Figure 25 Tamarack Bark

Ministry of Forest and Range – Government of British Columbia, 2001, Tree Book Tamarack, Copyright 2001 for the Province of British Columbia. Retrieved 30 March 2007, from <http://www.for.gov.bc.ca/hfd/librarydocuments/treebook/tamarack.htm>

USAGE

Twenty-three species of coniferous trees are used commercially. Conifers are mainly used for paper production and timber. They can also be used for:

- floors;
- mouldings; and
- bookcases.

FIREWOOD

Softwood makes a hot and fast burning fire; unfortunately, it does not last long.



Spruce is a poor fuel but it makes a good blaze for building up a fire.

CONFIRMATION OF TEACHING POINT 2

QUESTIONS

- Q1. Why are coniferous trees called evergreens?
- Q2. Name the two types of needles on coniferous trees.
- Q3. Name two of the most common coniferous trees in Canada.

ANTICIPATED ANSWERS

- A1. They do not shed their leaves in the winter.
- A2. Simple and clustered.
- A3. Cedar, fir, hemlock, larch, pine, spruce and tamarack.

Teaching Point 3

Conduct an Identification Activity

Time: 10 min

Method: Practical Activity



If an outside area with trees is not available, conduct the second activity in this TP.

ACTIVITY (OUTDOORS)

OBJECTIVE

The objective of this activity is for the cadets to identify at least one deciduous and one coniferous tree.

RESOURCES

- Bright-coloured tape; and
- Answer sheet located at Annex A.

ACTIVITY LAYOUT

Prior to the lesson, identify an area containing as many types of trees as possible. The four trees to identify should be marked with bright-coloured tape.

ACTIVITY INSTRUCTIONS

1. Have the cadets step outside the building and gather at the pre-determined area.
2. Outline safety rules.
3. Distribute the answer sheet located at Annex A.
4. Cadets should walk around the area and identify, on their answer sheet, the marked trees.
5. After five minutes, have the cadets gather around and review their answers.

SAFETY

Brief the cadets on any safety rules or boundaries pertaining to the outside activity.

ACTIVITY (INDOORS)

OBJECTIVE

The objective of this activity is for the cadets to identify at least one deciduous and one coniferous tree.

RESOURCES


- Tape;
- Answer sheet located at Annex A; and
- Pictures of trees located at Annex B.

ACTIVITY LAYOUT

Pictures of five different trees (located at Annex B) should be posted around the classroom.

ACTIVITY INSTRUCTIONS

1. Distribute the answer sheet located at Annex A.
2. Have the cadets walk around the room and identify the trees on the pictures.
3. After five minutes, have the cadets gather around and review their answers.



The five different trees in Annex B are:

- Species A – birch;
- Species B – hickory;
- Species C – oak;
- Species D – cedar;
- Species E – larch; and
- Species F – spruce.

SAFETY

N/A.

CONFIRMATION OF TEACHING POINT 3

The cadet's participation in the activity will serve as the confirmation of this TP.

END OF LESSON CONFIRMATION**QUESTIONS**

- Q1. Name four of the most common deciduous trees in Canada.
- Q2. What type of coniferous tree has overlapping scales?
- Q3. Name four of the most common coniferous trees in Canada.

ANTICIPATED ANSWERS

- A1. Alder, beech, birch, chestnut, elm, hickory, maple and oak.
- A2. Cedar.
- A3. Cedar, fir, hemlock, larch, pine, spruce and tamarack.

CONCLUSION

HOMEWORK/READING/PRACTICE

N/A.

METHOD OF EVALUATION

N/A.

CLOSING STATEMENT

Being familiar with the surrounding environment is essential to expeditions and weekend bivouac FTX. This knowledge will provide a better understanding of the species of trees needed for skills such as fire building or constructing field amenities.

INSTRUCTOR NOTES/REMARKS

N/A.

REFERENCES

- C0-117 (ISBN 1-58238-092-9) Brockman F.C. (2001). *Trees of North America: A Guide to Field Identification*. New York, USA: St. Martin's Press.
- C0-137 Natural Resources Canada. (2002). *Provincial Trees*. Retrieved 22 March 2007, from <http://www.cfl.scf.mcan.gc.ca/imfec-idecf/hosttrees/provincialtrees.html>.
- C2-004 (ISBN 1-896713-00-9) Tawrell, P. (1996). *Camping and Wilderness Survival: The Ultimate Outdoors Book*. Green Valley, ON: Paul Tawrell.
- C2-016 (ISBN 0-517-88783-5) Curtis, R. (1998). *The Backpacker's Field Manual: A Comprehensive Guide to Mastering Backcountry Skills*. New York, NY: Three Rivers Press.
- C2-068 (ISBN 0-425-10572-5) Brown, T., Jr., and Morgan B. (1983). *Tom Brown's Field Guide: Wilderness Survival*. New York, NY: The Berkley Publishing Group.

ANSWER SHEET

TREE IDENTIFICATION

1.
2.
3.
4.
5.

Notes

THIS PAGE INTENTIONALLY LEFT BLANK

PICTURES OF TREES

SPECIES A



Figure B-1 Tree Grove

Degree Confluence Project, 2006, Russia:Smolenskaya, Copyright 2006 for Alex Jarrett. Retrieved 4 April 2007 from <http://www.confluence.org/photo.php?visitid=8546&pic=ALL>



Figure B-2 Tree Bark

Richard's Notes, 2004, White Birch Bark, Copyright 2004 by Richard's Note. Retrieved 27 March 2007, from <http://www.richardsnotes.org/archives/2004/03/page/2/>

SPECIES B



Figure B-3 Tree

Wikipedia, 2006, Hickory. Copyright 2003 by Susan Sweeney. Retrieved 4 April 2007, from <http://en.wikipedia.org/wiki/hickory>



Figure B-4 Tree Bark

Firewood, Copyright 2007 by Donnan.com. Retrieved 27 March 2007, from <http://www.donnan.com/firewood.htm>

SPECIES C



Figure B-5 Tree

Islandnet.com, 2004, Beacon Hill Park History 1842-2004, Copyright 2004 by Janis Ringuette. Retrieved 4 April 2007, from <http://www.islandnet.com/beaconhillpark/contents/chapter1.htm>



Figure B-6 Tree Bark

Firewood, Copyright 2007 by Donnan.com. Retrieved 27 March 2007, from <http://www.donnan.com/firewood.htm>

SPECIES D

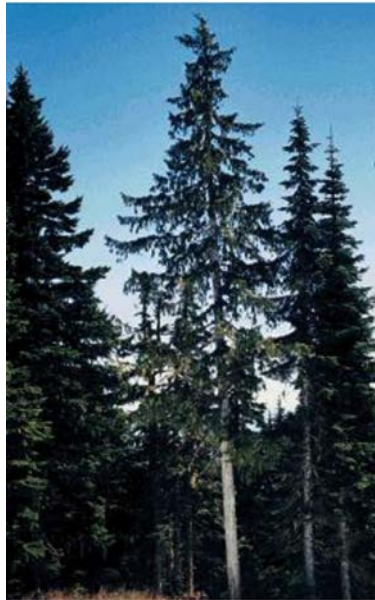


Figure B-7 Tree

Ministry of Forest and Range – Government of British Columbia, 2001, Tree Book-Yellow Cedar, Copyright 2001 by the Province of British Columbia. Retrieved 30 March 2007, from <http://www.for.gov.bc.ca/hfd/librarydocuments/treebook/yellowcedar.htm>



Figure B-8 Tree Bark

Wikipedia, 2006, Thuja Plicata. Retrieved 30 March 2007, from http://en.wikipedia.org/wiki/thuja_plicata

SPECIES E



Figure B-9 Tree

Ministry of Forest and Range – Government of British Columbia, 2001, Tree Book-Western Larch, Copyright 2001 by the Province of British Columbia. Retrieved 30 March 2007, from <http://www.for.gov.bc.ca/hfd/librarydocuments/treebook/westernlarch.htm>



Figure B-10 Tree Bark

Ministry of Forest and Range – Government of British Columbia, 2001, Tree Book Western Larch, Copyright 2001 by the Province of British Columbia. Retrieved 30 March 2007, from <http://www.for.gov.bc.ca/hfd/librarydocuments/treebook/westernlarch.htm>

SPECIES F



Figure B-11 Tree

Ashcroft Farm, 2006, Type of Christmas Trees, Copyright 2006 by Ashcroft Farm. Retrieved 4 April 2007, from <http://www.ashcroftfarm.com/types.html>



Figure B-12 Tree Bark

St. Mary's School, 2003, Mrs. Zvonar's Tree Page, Copyright 2003 by St. Mary's School. Retrieved 27 March 2007, from http://www.stmarysschool.net/whitesprucetree_cb.html



ROYAL CANADIAN ARMY CADETS

RED STAR

INSTRUCTIONAL GUIDE



SECTION 1

EO M222.01 – REVIEW GREEN STAR NAVIGATION

Total Time:

60 min

PREPARATION

PRE-LESSON INSTRUCTIONS

Resources needed for the delivery of this lesson are listed in the lesson specification located in A-CR-CCP-702/PG-001, Chapter 4. Specific uses for said resources are identified throughout the Instructional Guide within the TP for which they are required.

Review the lesson content and become familiar with the material prior to delivering the lesson.

Using a topographical map of the local area, to identify the objects, land features with grid references (GR) to be used during the activity.

Set up stations for the activity in TP2.

Copy the map folding activity sheet located at Annex A for each cadet.

PRE-LESSON ASSIGNMENT

N/A.

APPROACH

An interactive lecture was chosen for TP1 to present background material.

A practical activity was chosen for TP2 as it is an interactive way to allow cadets to experience navigation in a safe, controlled environment. This activity contributes to the development of navigation skills and knowledge in a fun and challenging setting.

INTRODUCTION

REVIEW

N/A.

OBJECTIVES

By the end of this lesson, the cadet shall have reviewed Green Star navigation skills to include:

- maintaining and folding a map;
- identifying marginal information;
- identifying conventional signs;

- identifying types of slopes;
- determining four and six-figure GR; and
- orienting a map by inspection.

IMPORTANCE

It is important for cadets to participate in a review of Green Star navigation training as it provides the building blocks for advanced navigation. This training must be mastered before cadets are taught new navigation skills in Red Star.

Teaching Point 1

Conduct a Review of Green Star Navigation

Time: 10 min

Method: Interactive Lecture



Do not spend too much time on any one point. Briefly review Green Star navigation. The activity will be used to confirm this lesson.

MAINTAINING AND FOLDING OF A MAP

Although there are waterproof maps of some areas, most maps are printed on regular paper. Paper maps are expensive and easily damaged. Therefore, precautions must be taken to protect them from water, dirt and wind damage.

Waterproofing a Map. When exposed to water, maps become soggy causing them to deteriorate and tear. Preparing a map for the elements is a vital step in prolonging the life of the map. The easiest and cheapest way to protect a map is to put it in a plastic sealable bag.

Drying a Map. If a map gets wet, let it dry completely on a clean flat surface.

Opening a Map. When a map is opened fully in a strong wind, not only is it impossible to read, but it could tear, get dirty, or even blow away. The map should only be opened to the area you are using, and refolded along the original fold lines.

Writing on a Map. Writing on a map should be done only when necessary. Always use pencil to mark your maps and when finished, gently erase all markings. Maps that are protected by plastic can be marked with grease pencils or erasable markers.

Storing a Map. Maps are to be stored in a dry place and should be rolled, folded, or laid flat.



Arrange the cadets so they can see the demonstration and hear the explanation of folding a map as listed below, prior to the cadets practicing this procedure.

Folding a Map. To fold a map:

1. lay the map face up;
2. fold the map in half by bringing the top (north) of the map sheet down to the bottom (south);

3. crease where the bend in the map has occurred, this is the centre of the map;
4. fold back the top half of the map sheet;
5. turn the map sheet over and fold the bottom half to match the top half;
6. fold the ends of the map in half from left to right; and
7. fold the ends back in half again so that the map name and index appear on the outside (the map should look like the letter M).

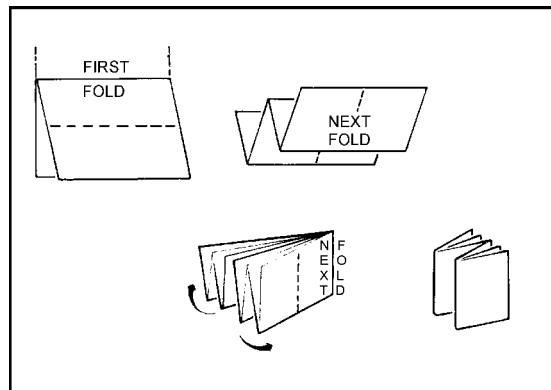


Figure 1 Folding a Map

A-CR-CCP-121/PT-001 (p. 5-5)

IDENTIFYING MARGINAL INFORMATION



Do not spend too much time on any one point. Briefly review Green Star navigation. The activity will be used to confirm this lesson.

A map, like any piece of equipment, has instructions that the user must read. It is important to know how to read these instructions. Marginal information is used to explain and describe the details found in the margins of the map. The common marginal information found on a map includes:

- name of the map sheet;
- number of the map and index of adjoining maps;
- date of map data;
- map scale;
- scale bars or graphic linear scales;
- contour interval;
- military index number (normally found at the top right corner of the map sheet which is used for ordering additional maps);
- declination diagram;

- Universal Transverse Mercator grid system (UTM); and
- legend of conventional signs.

IDENTIFYING CONVENTIONAL SIGNS

A conventional sign is a symbol used to indicate an object or item of detail, such as a building or a road. The meaning of most symbols is obvious. There are tables of conventional signs located in the margins and on the back of most maps. The use of different colours is a way of showing and distinguishing detail of all types of conventional signs.

INTERPRETING CONTOUR LINES

A contour line is a brown line on the map joining points of equal elevation. They are shown at regular vertical intervals. The difference in height between contours lines is called the contour interval. The contour interval is always stated in the margin of the map.

Interpreting contour lines and contour intervals provides a visualization of the shape of the ground. Correct interpretation of the shape of the ground from contour lines on the map will indicate the type of land feature on the ground. Some different types of land features are:

Steep Slope. This slope is identified when the contour lines are spaced closely together.

Gentle Slope. This slope is identified when the contour lines are further apart.

Uniform Slope. This slope is identified when the contours are an equal distance apart. The slope remains constant in its decline, whether steep or gentle.

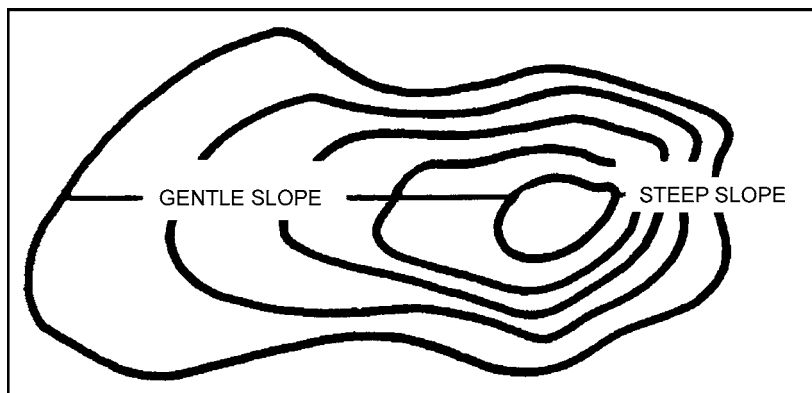


Figure 2 Slopes

D Cdts, Royal Canadian Army Cadets Basic Map Using, Department of National Defence (p. 1-44)

Concave Slope. This slope is identified when the spacing of the contours gets further apart at the bottom. The middle of the slope seems to depress inward – appearing concave.

Convex Slope. This slope is identified when the spacing of contours down a slope gets close together at the bottom. The middle of the slope seems to bulge outward – appearing convex.

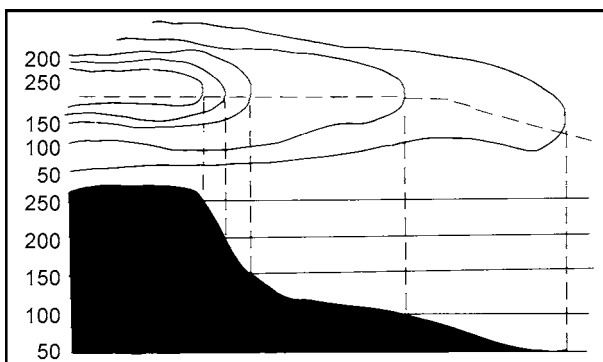


Figure 3 Concave Slope

B-GL-382-005/PT-001, Maps, Field Sketching, Compasses and the Global Positioning System (p. 32)

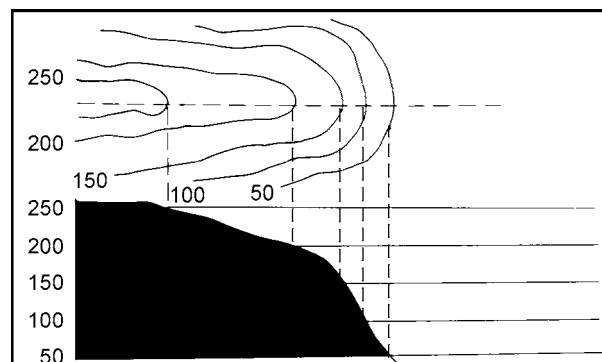


Figure 4 Convex Slope

B-GL-382-005/PT-001 (p. 32)

Spurs. A spur is a contour feature that extends out from a slope.

Re-entrants. A re-entrant is a contour feature that cuts back into a slope.

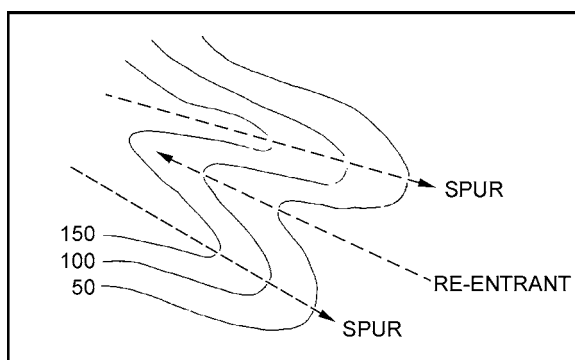


Figure 5 Spur/Re-entrant

B-GL-382-005/PT-001 (p. 32)

DETERMINING A GRID REFERENCE (GR)

Using the grid system, a grid reference (GR) identifies a location on a map. When determining a GR to a square, the reference is always to the southwest (bottom left) corner of the square. GRs are always given with the easting value first, followed by the northing value. A four-figure GR is used to identify a specific 1000 m by 1000 m grid square. A six-figure GR is used to determine a more accurate location within a specific 100 m by 100 m grid square.

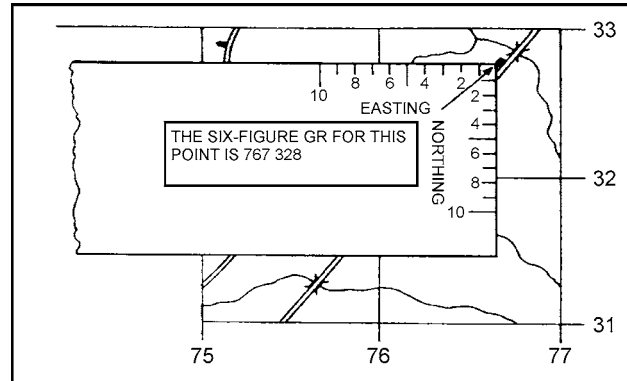


Figure 6 Determine a GR

A-CR-CCP-121/PT-001 (p. 5-20)

ORIENTING A MAP BY INSPECTION

Orienting a map by inspection means to visually pinpoint a location on the ground so that the cardinal directions on the map match directions on the ground. Orienting a map by inspection makes it easier to relate information on the map to features on the ground. To pinpoint a position more accurately, these steps must be followed:

1. Identify one's approximate position on the map.
2. Identify two or three prominent landmarks in different directions on the ground and find them on the map.
3. Rotate the map until all identified objects on the map line up with the direction in which objects are located on the ground. If near a straight stretch of road, orient the map by using the road. Line up the road on the map parallel with the road on the ground.
4. Check all around to verify that the terrain features to the front are in front of the position on the map, and so on. The top of the map now points north.

CONFIRMATION OF TEACHING POINT 1

The cadets' participation in the navigation round robin activity will serve as the confirmation of this TP.

Teaching Point 2

Time: 40 min

Conduct a Navigation Activity

Method: Practical Activity

ACTIVITY

OBJECTIVE

The objective of this activity is to confirm navigation training taught during Green Star.

RESOURCES

- 6 foot table (one per station);
- Romer (one per station);
- Topographical map (one per station);

- Map folding activity sheet located at Annex A;
- Land feature sheet located at Annex B; and
- Assistant instructor (one per group).

ACTIVITY LAYOUT

- This round robin activity will have four different stations spaced apart.
- Set up one 6 foot table per station.
- Place a map and a romer at each station.

ACTIVITY INSTRUCTIONS

In teams of no more than five cadets, the group will move through a series of stations to confirm Green Star Navigation material. This is to be conducted as group work, not individual work, meaning the whole group must agree on the final answer given. Groups will have eight minutes to complete the activity at each station and two minutes for debriefing.

- **Station 1 – Conventional Signs and Marginal Information.** Cadets will be asked to select five conventional signs from the legend and identify them on the map sheet. Then identify five items of marginal information and locate them on the map, which may include:
 - name of the map sheet;
 - number of the map sheet and index;
 - map scale and bar;
 - contour intervals; and
 - declination diagram.
- **Station 2 – Contour Lines and Features.** Cadets will identify two land features from the sheet located at Annex B and locate similar features on the map sheet.
- **Station 3 – Grid References (GR)**
 - Cadets will be given one four-figure GR and one six-figure GR and identify what is located at each GR.
 - Cadets will be given two distinct conventional signs on the map sheet. They must locate the object and give the six-figure GR of that object.
- **Station 4 – Orient a Map by Inspection and Fold a Map.** The cadets will be given a six-figure GR of their location and must orient the map by inspection. If this activity is being conducted indoors, draw symbols for some prominent objects, then place them on the walls for the cadets to use as a reference. Then cadets must complete the map folding activity so that the map index is seen.

SAFETY

N/A.

CONFIRMATION OF TEACHING POINT 2

The cadets' participation in the navigation round robin activity will serve as the confirmation of this TP.

END OF LESSON CONFIRMATION

QUESTIONS

- Q1. Why is it important to maintain and fold a map?
- Q2. What corner of the grid square is used when determining a GR?
- Q3. How many prominent objects should be used when orienting a map by inspection?

ANTICIPATED ANSWERS

- A1. Maintenance is important to prolong the life of the map sheet.
- A2. The GR is always to the southwest (bottom left) corner of the square.
- A3. When orienting a map by inspection, two or three prominent objects in different directions should be used.

CONCLUSION

HOMEWORK/READING/PRACTICE

N/A.

METHOD OF EVALUATION

N/A.

CLOSING STATEMENT

Map reading is a skill, and true proficiency will only be mastered by practice in the outdoors. The skills you have learned during Green Star are the building blocks required before moving on to more complex navigation training. Remember, practice makes perfect!

INSTRUCTOR NOTES/REMARKS

A thorough understanding of Green Star navigation training is required before cadets are taught new navigation skills in Red Star. This EO will provide an opportunity for cadets to practice skills they learned in the corps program.

REFERENCES

A2-041 B-GL-382-005/PT-001 Canadian Forces. (2006). *Maps, Field Sketching, Compasses and the Global Positioning System*. Ottawa, ON: Department of National Defence.

MAP FOLDING ACTIVITY SHEET

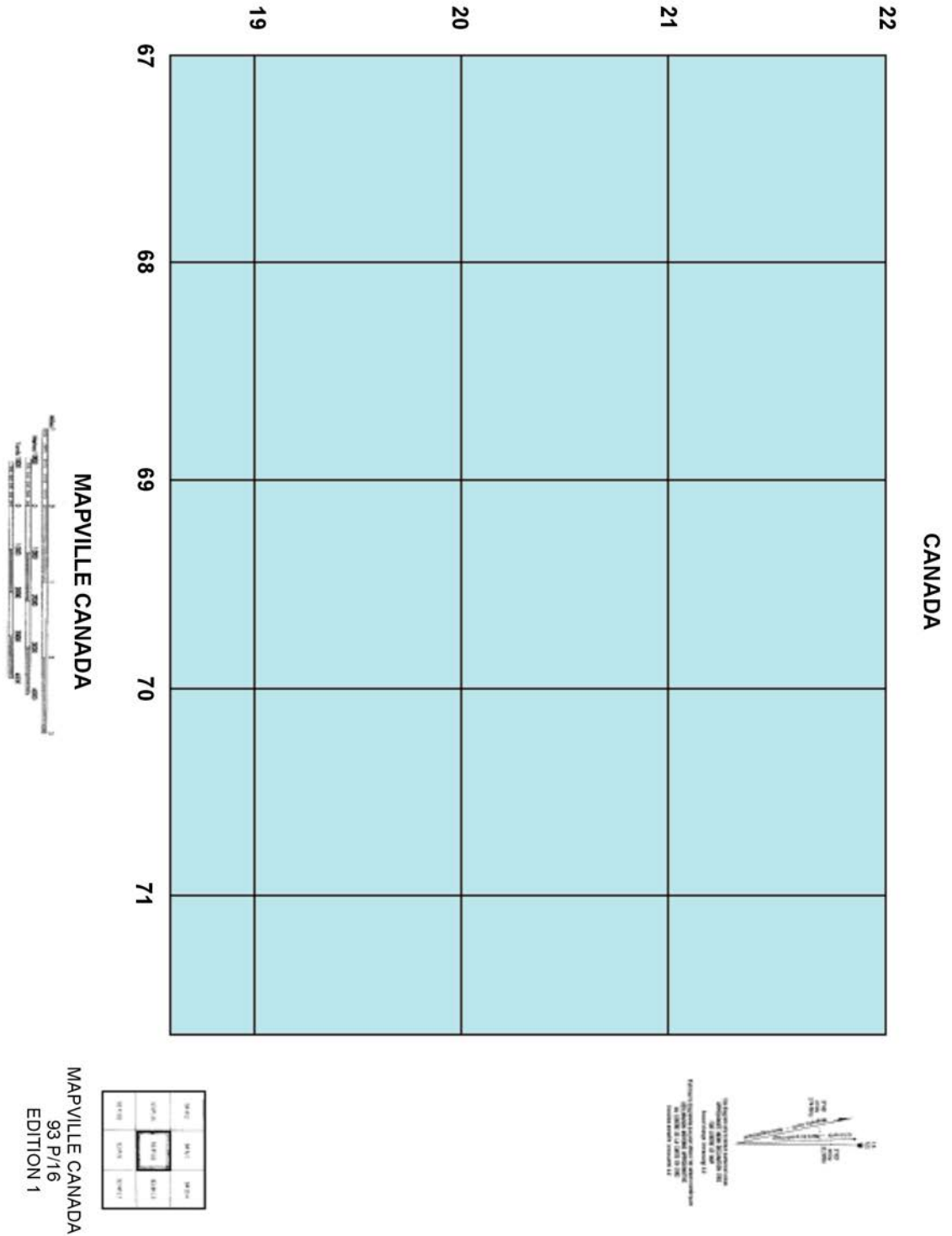


Figure A-1 Map Folding Activity Sheet

D Cds 3, 2007, Ottawa, ON: Department of National Defence

THIS PAGE INTENTIONALLY LEFT BLANK

LAND FEATURES



A



B



C



D



E



F

Figure B-1 Contour Features

D Cdts 3, 2007, Ottawa, ON: Department of National Defence

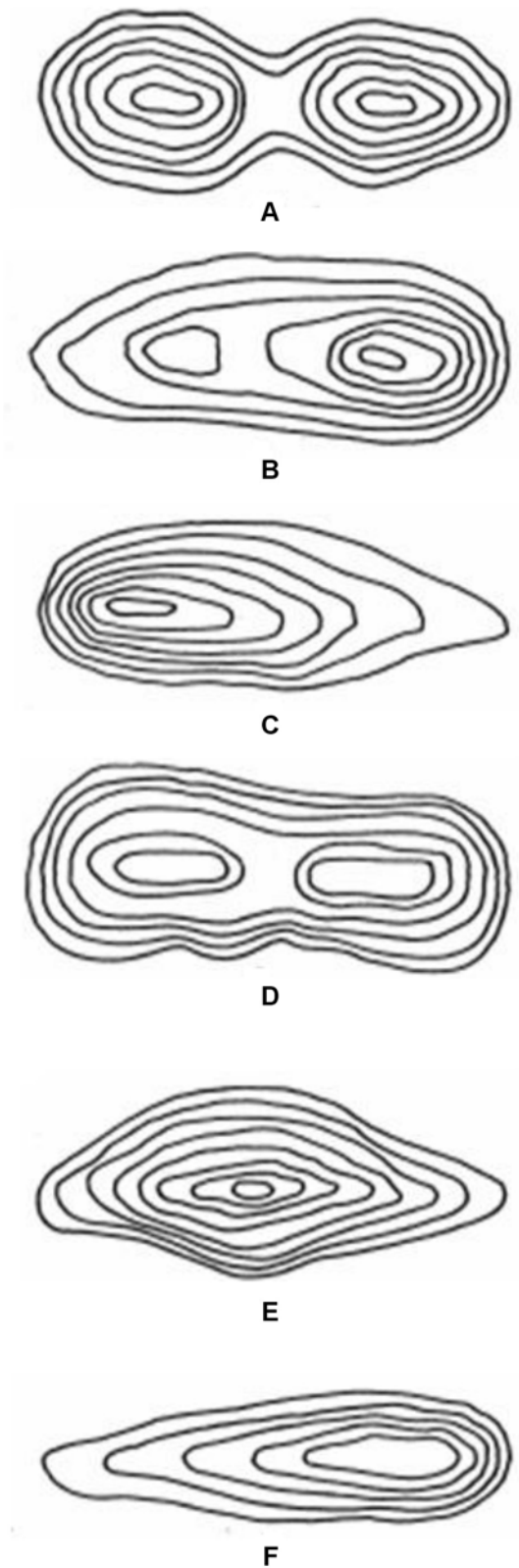


Figure B-2 Contour Features Examples

D Cnts 3, 2007, Ottawa, ON: Department of National Defence



ROYAL CANADIAN ARMY CADETS

RED STAR

INSTRUCTIONAL GUIDE



SECTION 2

EO M222.02 – DESCRIBE BEARINGS

Total Time:

60 min

PREPARATION

PRE-LESSON INSTRUCTIONS

Resources needed for the delivery of this lesson are listed in the lesson specification located in A-CR-CCP-702/PG-001, Chapter 4. Specific uses for said resources are identified throughout the Instructional Guide within the TP for which they are required.

Review the lesson content and become familiar with the material prior to delivering the lesson.

Photocopy the compass rose activity sheet located at Annex A for each pair of cadets.

PRE-LESSON ASSIGNMENT

N/A.

APPROACH

An interactive lecture was chosen for TP1 to TP4 to present basic material, orient the cadets to bearings, and to generate interest.

A practical activity was chosen for TP5 as it is an interactive way to introduce cadets to bearings. This activity contributes to the development of navigation skills and knowledge in a fun and challenging setting.

INTRODUCTION

REVIEW

N/A.

OBJECTIVES

By the end of this lesson the cadet shall be expected to:

- identify the 16 points of a compass;
- define mils and degrees;
- identify true, grid, and magnetic north; and
- describe bearings.

IMPORTANCE

It is important for cadets to describe bearings as this will assist them in finding the direction of identifiable landmarks on a map. Cadets will rely on this skill set throughout navigation and expedition training.

Teaching Point 1

Identify and Explain the 16 Points of a Compass

Time: 10 min

Method: Interactive Lecture



Draw a compass rose (circle) on the board with the four cardinal points. Draw a new line each time you introduce the inter-cardinal and intermediate points.

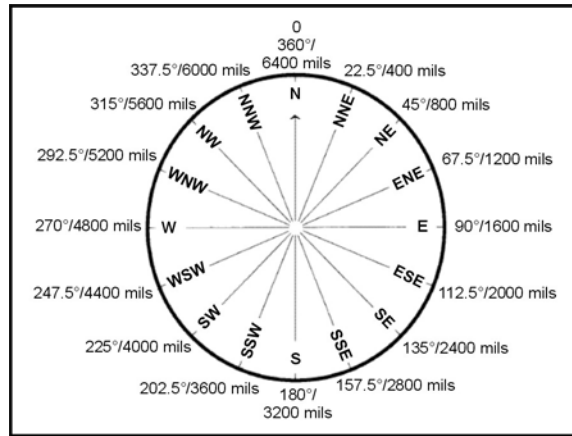


Figure 1 Compass Rose

D Cds 3, 2007, Ottawa, ON: Department of National Defence

FOUR CARDINAL POINTS

The four cardinal points of the compass, measured at right angles clockwise are north (N), east (E), south (S) and west (W). They can be easily remembered by the using mnemonics, such as “Never Eat Shredded Wheat”.

FOUR INTER-CARDINAL POINTS

The four inter-cardinal points are located halfway between each of the cardinal points. Measured clockwise, they are:

1. north-east (NE);
2. south-east (SE);
3. south-west (SW); and
4. north-west (NW).

EIGHT INTERMEDIATE POINTS

The eight intermediate points are located halfway between each cardinal point and inter-cardinal point. Measured clockwise, they are:

1. north-north-east (NNE);
2. east-north-east (ENE);
3. east-south-east (ESE);
4. south-south-east (SSE);
5. south-south-west (SSW);
6. west-south-west (WSW);
7. west-north-west (WNW); and
8. north-north-west (NNW).

CONFIRMATION OF TEACHING POINT 1

QUESTIONS

- Q1. What is a mnemonic used to remember the four cardinal points?
- Q2. What are the four inter-cardinal points?
- Q3. How many intermediate points are there?

ANTICIPATED ANSWERS

- A1. “Never Eat Shredded Wheat”.
- A2. North-east (NE), south-east (SE), south-west (SW) and north-west (NW).
- A3. There are eight intermediate points.

Teaching Point 2

Explain the Scales on a Compass

Time: 5 min

Method: Interactive Lecture



Using the compass rose from TP1, add the degree and mils values on the outside of the circle for the cardinal points (N, E, S and W).

To express direction in an accurate and precise method, the full circle of the compass rose is divided into equal measures of angle. This measurement starts and ends at north (top) and always moves in a clockwise rotation. There are two main scales used to measure a circle – they are degrees and mils.

Degrees. The most common method of dividing a circle is by degrees. There are 360 equal angles in a complete circle and they are represented by the degree symbol (e.g. 360°). On the compass rose, north is located at 0 and 360 degrees, east is located at 90 degrees, south is located at 180 degrees and west is located at 270 degrees.

Mils. When a more accurate division of the same circle is required, the metric milli-radian (mils) method is used. The mils method has a military background and is based on the metric system with 6400 equal angles in a complete circle. On the compass rose, north is located at 0 and 6400 mils, east is located at 1600 mils, south is located at 3200 mils and west is located at 4800 mils.



There are 22.5 degrees or 400 mils between each point on a compass rose.

CONFIRMATION OF TEACHING POINT 2

QUESTIONS

- Q1. How many degrees make a complete circle?
- Q2. How many mils make a complete circle?
- Q3. Which are more accurate, degrees or mils?

ANTICIPATED ANSWERS

- A1. 360 degrees.
- A2. 6400 mils.
- A3. Mils.

Teaching Point 3

Identify and Explain the Three Norths

Time: 10 min

Method: Interactive Lecture

In navigation there are three different norths that are used – true north, grid north and magnetic north. Each north varies a small amount from each other and must be known for use in navigation. A diagram representing the three norths can be found in the margin of the map being used.



Draw Figure 2 on the board and draw the symbol for each north as it is explained to the cadets.

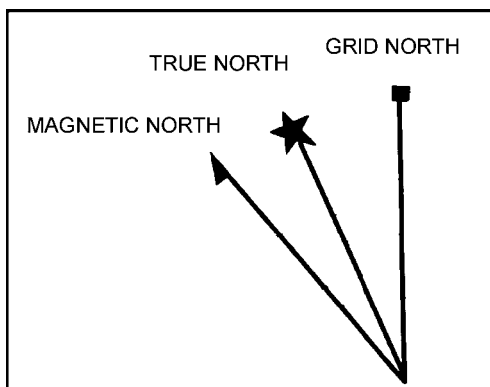


Figure 2 Three Norths

B-GL-382-005/PT-001 (p. 51)

True North. True north is located at the top of the earth where the geographic North Pole is found, and is where all lines of longitude meet. In the diagram on the map, true north is represented by a star (Polaris).

Grid North. Grid north is the north indicated by the grid lines (eastings) on a topographical map. The easting lines run parallel to each other and will never meet at the North Pole; because of this, grid north points off slightly from true north. In the diagram on the map, grid north is represented by a square (map grid).

Magnetic North. Magnetic north is the direction in which the compass needle points. This direction is to the magnetic pole which is located in the Canadian arctic and is slightly different from true north (North Pole). In the diagram on the map, magnetic north is represented by a needle (compass).

CONFIRMATION OF TEACHING POINT 3

QUESTIONS

- Q1. What symbol is used to represent true north?
- Q2. What symbol is used to represent grid north?
- Q3. What symbol is used to represent magnetic north?

ANTICIPATED ANSWERS

- A1. A star, as in Polaris.
- A2. A square, as in a grid square.
- A3. A needle, as in a compass.

Teaching Point 4

Explain Bearings

Time: 10 min

Method: Interactive Lecture



Poll the cadets to define an angle as they have learned in school. To represent the cardinal points; stand at the front of the class (N) and have one cadet stand six paces in front of you (S), another three paces in front and three paces to the left (E) and another three paces in front and three paces to the right (W). Using the centre point, ask the cadets what are the angles between you and each cadet.

DEFINITION OF A BEARING

Bearing. A bearing is an angle that is measured clockwise, from a fixed zero line; north is always this zero line. Simply, a bearing is just another name for an angle.

TYPES OF BEARINGS

Grid Bearings. A grid bearing is a bearing that is measure between two points on a map. The ability to measure a bearing from a map allows a map user to plan routes or activities before going into the field, and allows an easy method of communicating information about movement or location.

Magnetic Bearings. A magnetic bearing is a bearing that is measured between two points using a compass. A magnetic bearing is a quick and efficient method of describing a route to take. The bearing alone is usually not enough information to navigate with and must also have distance or a target object.

Back Bearing. A back bearing is a bearing that is in the exact opposite direction of the bearing that has been measured. A back bearing can be useful for different reasons; to return to the start location after a hike, or to calculate the bearing from an object to one's current location. Depending on the compass being used, the steps to calculate a back bearing are:

- If the bearing is less than 3200 mils or 180 degrees, add 3200 mils or 180 degrees.
- If the bearing is greater than 3200 mils or 180 degrees, subtract 3200 mils or 180 degrees.



In the 1920's, it became accepted world wide to indicate direction by a number representing an angle, measured clockwise from True North; called a "bearing".

CONFIRMATION OF TEACHING POINT 4

QUESTIONS

- Q1. What is another name for an angle?
- Q2. What is a grid bearing?
- Q3. What is a magnetic bearing?

ANTICIPATED ANSWERS

- A1. A bearing.
- A2. A bearing measured on a map.
- A3. A bearing measured with a compass.

Teaching Point 5**Complete a Compass Rose Activity**

Time: 15 min

Method: Practical Activity

ACTIVITY**OBJECTIVE**

The objective of this activity is to have cadets label a compass rose with the inter-cardinal points and the degrees and mils value for each.

RESOURCES

Compass rose activity sheet located at Annex A of this Instructional Guide.

ACTIVITY LAYOUT

N/A.

ACTIVITY INSTRUCTIONS

1. Divide the cadets into pairs.
2. Issue each cadet with a copy of the compass rose activity sheet.
3. Allow cadets five to seven minutes to complete the activity sheet as a team.
4. Review answers starting at north to include compass point name, degrees and mils.
5. Allow cadets to keep activity sheets for future reference.

SAFETY

N/A.

CONFIRMATION OF TEACHING POINT 5

The cadets' participation in the compass rose activity will serve as the confirmation of this TP.

END OF LESSON CONFIRMATION**QUESTIONS**

- Q1. What is another name for a bearing?
- Q2. How many degrees and how many mils make a complete circle?
- Q3. What symbols are used to represent the three norths?

ANTICIPATED ANSWERS

- A1. An angle.
- A2. 360 degrees and 6400 mils.
- A3. True north is a star (Polaris), grid north is a square (map grid) and magnetic north is a needle (compass).

CONCLUSION

HOMEWORK/READING/PRACTICE

N/A.

METHOD OF EVALUATION

N/A.

CLOSING STATEMENT

Being able to describe bearings is an important aspect of navigation training, as it allows cadets to identify direction when travelling from one point to another.

INSTRUCTOR NOTES/REMARKS

N/A.

REFERENCES

A2-041 B-GL-382-005/PT-001 Canadian Forces. (2006). *Maps, Field Sketching, Compasses and the Global Positioning System*. Ottawa, ON: Department of National Defence.

COMPASS ROSE ACTIVITY SHEET

Fill in the missing detail for each point of the compass rose

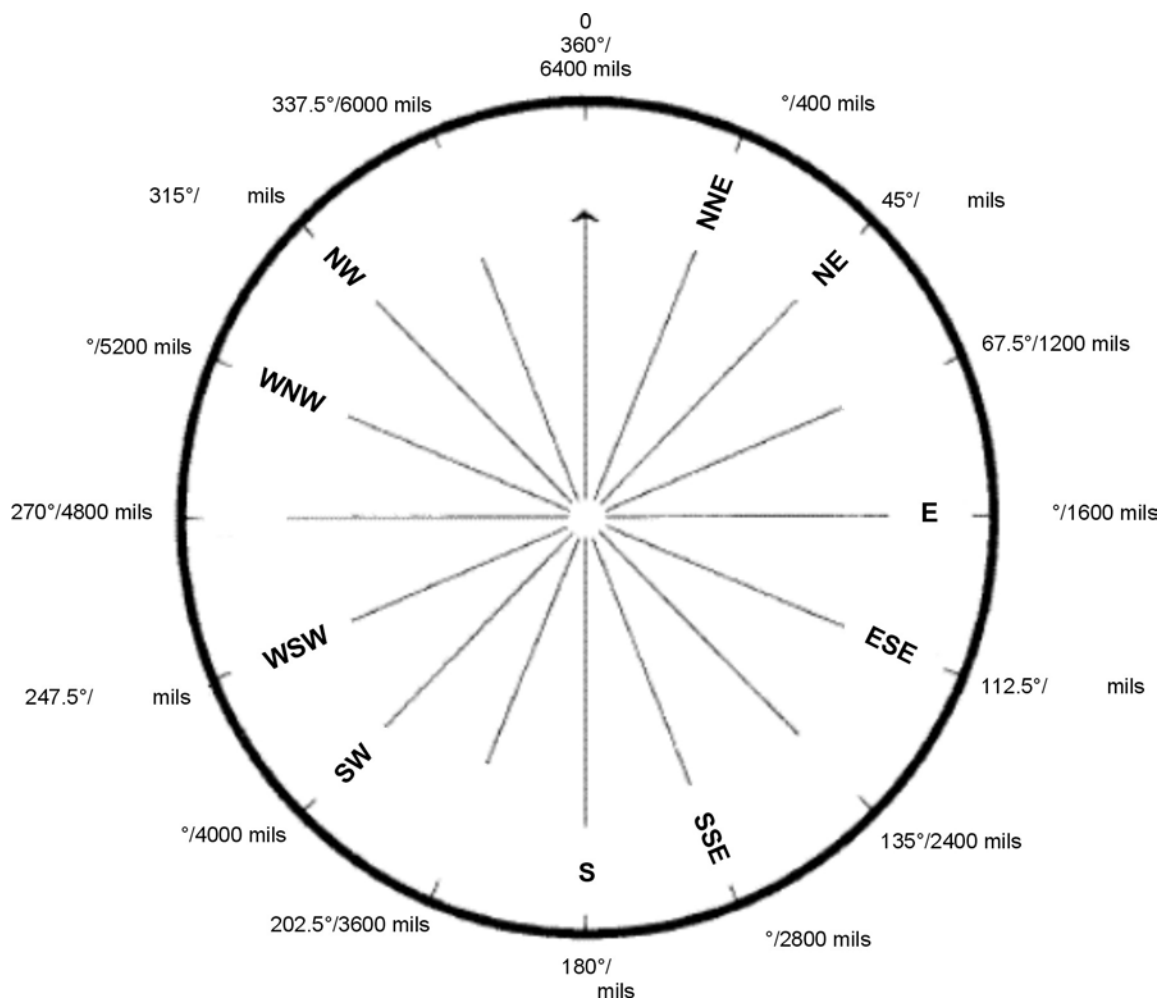


Figure A-1 Compass Rose Activity

D Cds 3, 2007, Ottawa, ON: Department of National Defence

THIS PAGE INTENTIONALLY LEFT BLANK



ROYAL CANADIAN ARMY CADETS

RED STAR

INSTRUCTIONAL GUIDE



SECTION 3

EO M222.03 – IDENTIFY COMPASS PARTS

Total Time:

30 min

PREPARATION

PRE-LESSON INSTRUCTIONS

Resources needed for the delivery of this lesson are listed in the lesson specification located in A-CR-CCP-702/PG-001, Chapter 4. Specific uses for said resources are identified throughout the Instructional Guide within the TP for which they are required.

Review the lesson content and become familiar with the material prior to delivering the lesson.

Calculate the magnetic declination for the map being used.

PRE-LESSON ASSIGNMENT

N/A.

APPROACH

An interactive lecture was chosen for TP1 to present basic material, orient the cadets to the compass, and generate interest.

Demonstration and performance was chosen for TP2 as it allows the instructor to explain and demonstrate the navigation skills the cadets are expected to acquire, while providing an opportunity for the cadets to practice navigation under supervision.

INTRODUCTION

REVIEW

The review for this lesson is from EO M222.02 (Describe Bearings).

QUESTIONS

- Q1. What are the four inter-cardinal points of a compass rose?
- Q2. How many degrees and how many mils make a complete circle?
- Q3. What symbols are used to represent the three norths?

ANTICIPATED ANSWERS

- A1. North-east, south-east, south-west and north-west.
- A2. 360 degrees and 6400 mils.
- A3. True north is a star (Polaris), grid north is a square (map grid) and magnetic north is a needle (compass).

OBJECTIVES

By the end of this lesson the cadet shall have identified the parts of the compass.

IMPORTANCE

It is important for cadets to be able to use a compass while navigating during expedition training. Each part of the compass has a specific name used to identify the part and its function. Cadets will rely on this information throughout navigation and expedition training.

Teaching Point 1

Identify and Describe the Parts of the Compass

Time: 5 min

Method: Interactive Lecture

INTRODUCTION

The compass is an important tool used in wilderness navigation. It is not a replacement for good map techniques, but it is a trustworthy tool to compliment and complete navigation skills. A compass user must take care to be precise in their measurements with the compass. A small error in calculation or measurement can equal a significant error in the field.

A magnetic compass is still viable as a navigation aid, even with the advent of Global Positioning System devices, because it requires no batteries, and remains reliable year after year.



The Chinese discovered the orientating effect of magnetite, or lodestone as early as the 4th century BC. In 101 BC, Chinese ships reached the east coast of India for the first time, possibly with help from a magnetic compass. By the 10th century, they had developed a floating compass for use at sea. Western Europeans had developed one by 1187, Arabs by 1220, and Scandinavians by 1300. Columbus used a magnetic compass on his first trans-Atlantic trip in 1492 (see Figure 1).



CHINESE FLOATING COMPASS

Figure 1 Chinese Floating Compass

A-CR-CCP-121/PT-001 (p. 5-33)

HOW A COMPASS WORKS

Regardless of their intended purpose or the complexity of their construction, most compasses operate on the same basic principle. A small, elongated, permanently magnetized needle is placed on a pivot so that it may rotate freely in the horizontal plane. The Earth's magnetic field which is shaped approximately like the field around a simple bar magnet exerts forces on the compass needle, causing it to rotate until it comes to rest in the same horizontal direction as the magnetic field. Over much of the Earth, this direction is roughly true north, which accounts for the compass's importance for navigation. The Earth has a north and a south magnetic pole. These magnetic poles correspond roughly with the actual geographical poles. The north magnetic pole is located at approximately 78.9°N latitude and 103.8°W, about 1000 km from the geological north pole.

The horizontal force of the magnetic field, responsible for the direction in which a compass needle is oriented, decreases in strength as one approaches the north magnetic pole – the compass starts to behave erratically, and eventually, as the horizontal force decreases even more, the compass becomes unusable.

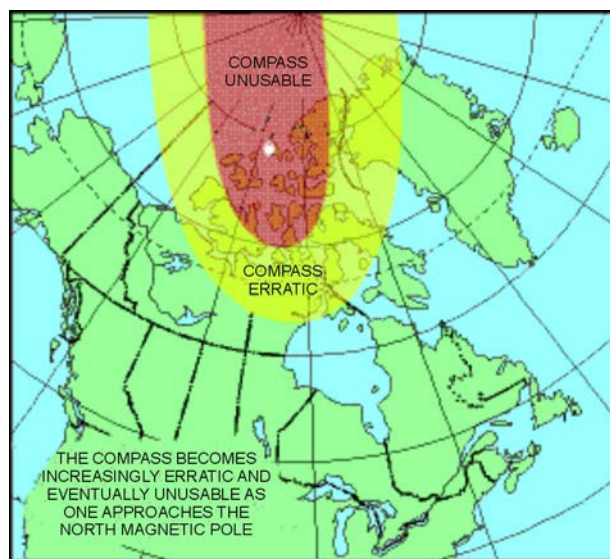


Figure 2 Earth's Magnetic Field

A-CR-CCP-121/PT-001 (p. 5-33)

The nature of the magnetic field allows the magnetic north pole to shift geographic position about 5-10 cm per year. Other natural phenomena, like earthquakes, can change the magnetic field locally.

Teaching Point 2

Identify and Describe the Parts of the Compass

Time: 10 min

Method: Interactive Lecture



Divide cadets into equal groups according to the number of compasses available. Starting with the compass opened, use the diagram in Figure 3 to identify the parts of the compass from the top (sight) to the bottom (screwdriver).

PARTS OF THE COMPASS

A – Sight. Located at the top of the compass cover, the sight is used to align an objective or bearing.

B – Compass Cover. The compass cover protects the compass dial and houses the sighting mirror.

C – Sighting Mirror. The sighting mirror is used to see the compass dial while setting a bearing.

D – Sighting Line. The sighting line is used when aligning the objective or bearing.

E – Luminous Index Point. The luminous index point at the top of the compass dial is where a bearing is set and read from.

F – Compass Dial. The compass dial houses the magnetic needle, the orienting arrow and the declination scale on the inside and the dial graduations on the outside.

G – Dial Graduations. The compass dial is graduated in 50 mil divisions from 0 to 6400 mils, or 2 degree divisions from 0 to 360 degrees. The dial is rotated by hand.

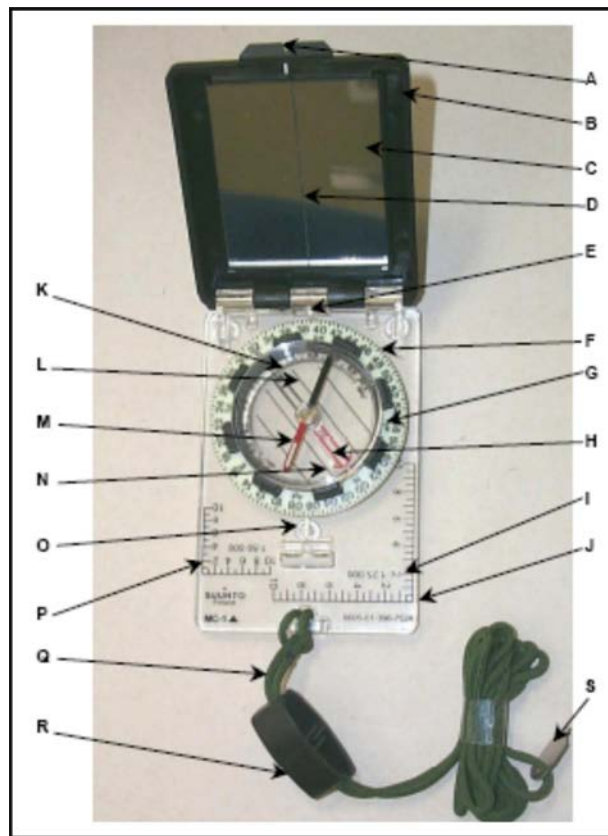


Figure 3 Compass

A-CR-CCP-121/PT-001 (p. 5-33)



This Instructional Guide is good for use with compasses that have dial graduations in either mils or degrees.

H – Orienting Arrow. The red orienting arrow is located inside the compass dial and is used to line up the magnetic needle. The orienting arrow is always set at 00 mils/degrees.

I – Romer 1:25 000. This romer is used to measure GR on maps with a 1:25 000 scale.

J – Compass Base Plate. The compass base plate is a clear piece of flat plastic, to which the cover, dial and lanyard are attached.

K – Declination Scale. The declination scale is used to compensate for the variation of magnetic declination between the compass and the map being used.

L – Compass Meridian Lines. Compass meridian lines are black or red lines inside the compass dial and are used to line up the compass dial with the grid lines on a map.

M – Magnetic Needle. The magnetic needle spins freely and points to magnetic north. The south end of the compass needle is black and the north end, with a luminous patch, is red.



When the magnetic needle is lined up with the red orienting arrows, the mnemonic “Red in the Bed” is used to remember which end of the needle belongs between the arrows.

N – Luminous Orienting Points. There are two luminous orienting points located on either side of the orienting arrow.

O – Luminous Index Point. The luminous orienting point at the bottom of the compass dial is where a back bearing is read from.

P – Romer 1:50 000. This romer is used to measure GR on maps with a 1:50 000 scale.

Q – Safety Cord or Lanyard. The safety cord is used to fasten the compass to the body.

R – Adjustable Wrist Lock. The adjustable wrist lock is used to attach the compass to the wrist.

S – Screwdriver. The tiny screwdriver at the end of the safety cord is used to turn the screw to adjust the declination scale.

T – Declination Adjustment Screw. The declination adjustment screw is located on the back side of the compass dial and is used to adjust the declination scale (not shown).



When exposed to direct light, all luminous parts of the compass will glow in the dark making operating the compass at night possible.

CONFIRMATION OF TEACHING POINT 2

QUESTIONS

- Q1. What is the maximum number of mils or degrees on the dial graduations?
- Q2. What mnemonic is use for putting the magnetic needle between the orienting arrows?
- Q3. What direction does the red part of the magnetic needle point?

ANTICIPATED ANSWERS


- A1. 6400 mils or 360 degrees.
- A2. "Red in the Bed".
- A3. Magnetic north.

Teaching Point 3

Explain, Demonstrate and Have Cadets Practice Setting Declination

Time: 10 min

Method: Demonstration and Performance



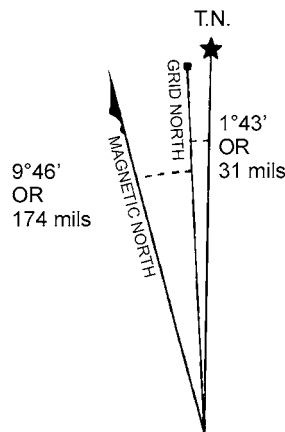
Explain and demonstrate setting declination as listed below, prior to cadets practicing this procedure. Cadets will only learn how to set declination on the compass with a value provided by the instructor. Calculating declination will be taught in Silver Star.

As mentioned in EO M222.02 (Describe Bearings), there is a difference in angle between true and magnetic north.

DECLINATION

Also called magnetic declination, it is the difference in angle measured in degrees and minutes between true north (map) and magnetic north (compass). Declination will change depending on geographic position and it also changes annually due to the shifting magnetic pole.

Declination is further described by stating whether the declination is east or west of true north. The declination for the map being used is calculated using the information in the declination diagram found in the margin of the map.



USE DIAGRAM ONLY TO OBTAIN NUMERICAL VALUES
 APPROXIMATE MEAN DECLINATION 1982
 FOR CENTRE OF MAP
 ANNUAL CHANGE (INCREASING) 4.4'

Figure 4 Declination Diagram

A-CR-CCP-121/PT-001 (p. 5-39)

SETTING DECLINATION ON A COMPASS

The compass's declination scale must be set to compensate for the difference between true north and magnetic north. To do this we must first have the amount of declination in degrees east or west. Then, turn the compass over and look at the back of the dial.

From the zero point, using the screwdriver on the end of the safety cord, turn the declination screw to the right for west and to the left for east declination. Each small black line is two degrees.



When setting declination on a compass, it is easier to hold the screwdriver and turn the compass, especially in cold weather. The declination shall never be turned past 90° on the declination scale.



Figure 5 Declination Screw

D Cds 3, 2007, Ottawa, ON: Department of National Defence



If you were to follow a compass bearing for 1 km without adjusting for declination, for every 1 degree not accounted for, you would be 178 metres to the left or right of the plotted bearing. This is how important declination is.

CONFIRMATION OF TEACHING POINT 3



Divide cadets into equal groups according to the number of compasses available. Giving a different declination setting each time, have cadets take turns setting the declination on a compass. Verify each setting before continuing to the next setting.

The cadets' participation in setting declination will serve as the confirmation of this TP.

END OF LESSON CONFIRMATION

QUESTIONS

- Q1. What is the screwdriver on the compass used for?
- Q2. What two directions are used to describe declination?
- Q3. What direction is the declination adjusting screw turned to set an east declination?

ANTICIPATED ANSWERS

- A1. To turn the declination adjusting screw.
- A2. East and west.
- A3. Left.

CONCLUSION

HOMEWORK/READING/PRACTICE

N/A.

METHOD OF EVALUATION

N/A.

CLOSING STATEMENT

Compasses are used during navigation and trekking training exercises. Identification of the parts and the proper use of the compass is essential to ensuring accurate navigation.

INSTRUCTOR NOTES/REMARKS

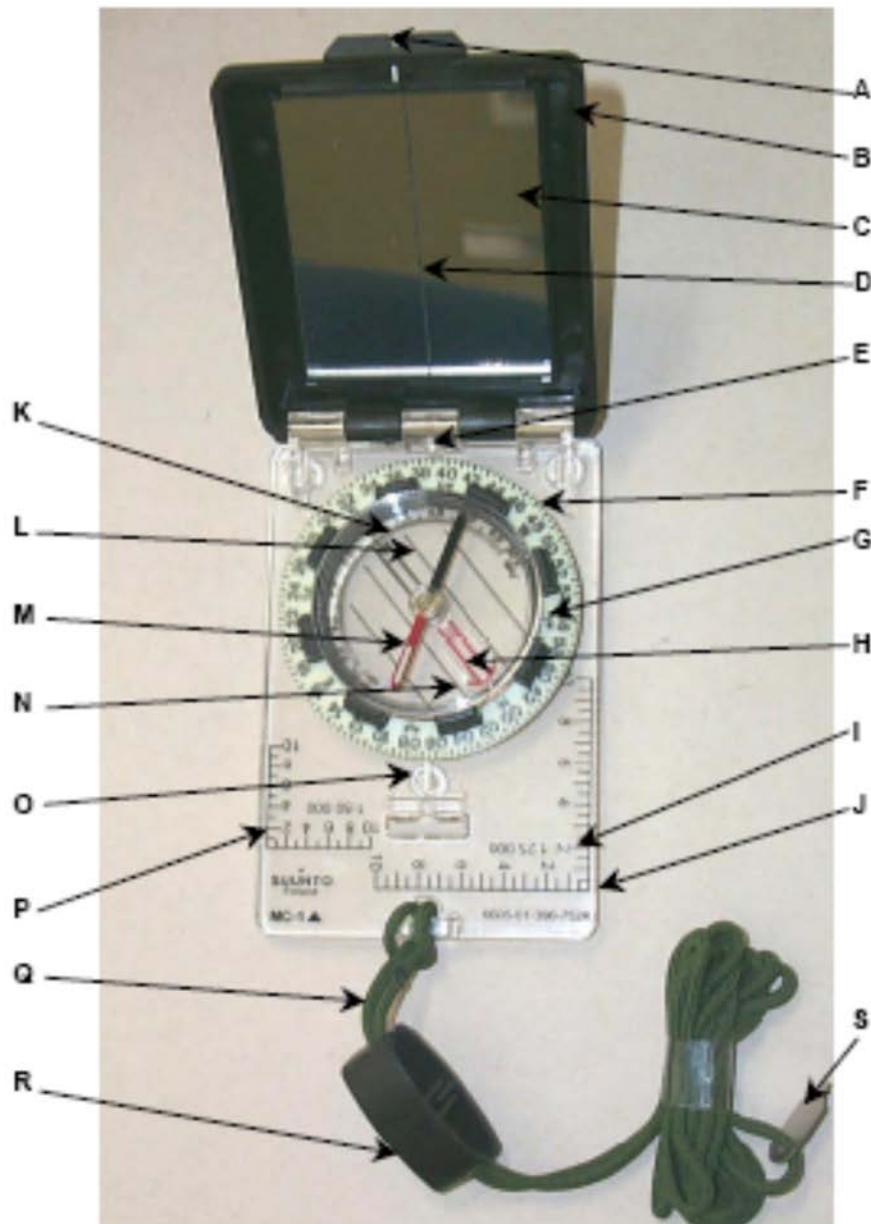
N/A.

REFERENCES

A2-036 A-CR-CCP-121/PT-001 D Cdts (2003). *Royal Canadian Army Cadet Reference Book*. Ottawa, ON: Department of National Defence.

A2-041 B-GL-382-005/PT-001 Canadian Forces. (2006). *Maps, Field Sketching, Compasses and the Global Positioning System*. Ottawa, ON: Department of National Defence.

COMPASS PARTS



LEGEND

A - Sight	B - Compass Cover	C - Sighting Mirror	D - Sighting Line
E - Luminous Index Point	F - Compass Dial	G - Dial Graduations	H - Orienting Arrows
I - Romer 1:25,000	J - Compass Base Plate	K - Declination Scale	L - Compass Meridian lines
M - Magnetic Needle	N - Luminous Orienting Points	O - Luminous Index Point	P - Romer 1:50,000
Q - Safety Cord or Lanyard	R - Adjustable Wrist Lock	S - Screwdriver	T - Declination Adjusting Screw (not shown)

THIS PAGE INTENTIONALLY LEFT BLANK



ROYAL CANADIAN ARMY CADETS

RED STAR

INSTRUCTIONAL GUIDE



SECTION 4

EO M222.04 – DETERMINE DISTANCE ALONG A ROUTE

Total Time:	90 min
-------------	--------

PREPARATION

PRE-LESSON INSTRUCTIONS

Resources needed for the delivery of this lesson are listed in the lesson specification located in A-CR-CCP-702/PG-001, Chapter 4. Specific uses for said resources are identified throughout the Instructional Guide within the TP for which they are required.

Review the lesson content and become familiar with the material prior to delivering the lesson.

Using a topographical map of the local area, identify at least three different sets of points (A to B) to be measured during the activity in TP1.

Measure and identify 100 m to be used for establishing individual pace during TP2.

PRE-LESSON ASSIGNMENT

N/A.

APPROACH

Demonstration and performance was chosen for TP1 and TP2 as it allows the instructor to explain and demonstrate determining distance along a route while providing an opportunity for the cadets to practice these skills under supervision.

An interactive lecture was chosen for TP3 to clarify and emphasize the limitations of individual pacing.

INTRODUCTION

REVIEW

N/A.

OBJECTIVES

By the end of this lesson, the cadet shall be expected to determine distance along a route.

IMPORTANCE

It is important for cadets to be able to determine the distance along a route and pace a route as it allows them to calculate the distance between two points and to estimate the amount of time required to reach an objective or destination.

Teaching Point 1**Explain, Demonstrate and Have Cadets Practice Determining Distance on a Map**

Time: 25 min

Method: Demonstration and Performance



For this skill lesson, it is recommended that instruction take the following format:

1. Explain and demonstrate the complete skill while cadets observe.
2. Explain and demonstrate each step required to complete the skill. Monitor cadets as they imitate each step.
3. Monitor the cadets' performance as they practice the complete skill.

Note: Assistant instructors may be used to monitor cadet performance.

DETERMINING DISTANCE ON A MAP

Cadets can use their maps to measure the distance between two points (A and B) on the ground. All maps are drawn to scale; therefore, a specified distance on a map equals a specified distance on the ground. The scale of a map is printed at the top and bottom of each map (e.g. Scale 1:50 000). This means that one cm on the map equals 50 000 cm (500 m) on the ground.

There are two ways to determine distance on a topographical map – point to point and along a route.

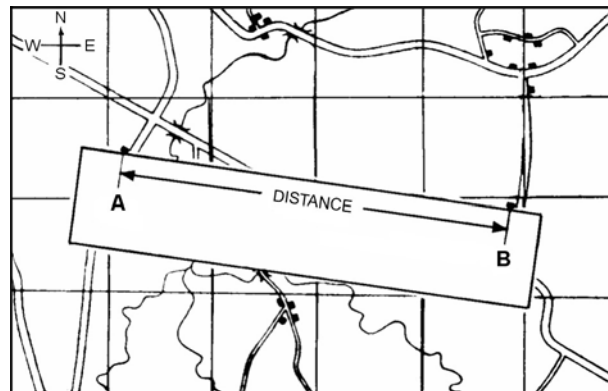
Measuring Point to Point

Figure 1 Measure Distance Point to Point

A-CR-CCP-121/PT-001 (p. 5-24)

To measure a distance point to point:

1. lay the straight edge of a piece of paper against the two points;
2. with a sharp pencil, mark the paper at the A (start) and B (finish) points;
3. lay the paper just under the scale bar (metres) and move the B mark backwards to each thousands mark until the A mark falls within the sub-divided thousands (hundreds) to the left of the zero; and
4. to calculate the total distance, add the number of thousands where the B mark is, plus the number of sub-divided thousands where the A mark is to the left of the zero.

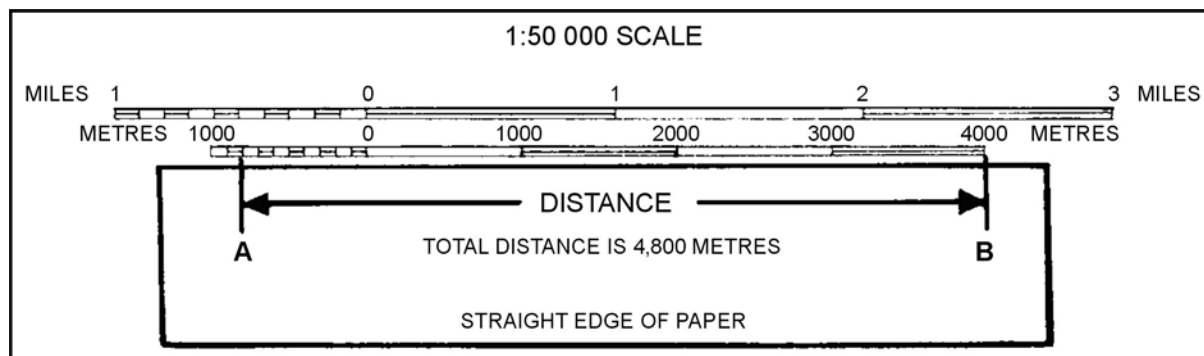


Figure 2 Calculate Distance

A-CR-CCP-121/PT-001 (p. 5-25)



For a distance that is longer than 5000 m, measure the first 5000 m and mark the paper with a new line and label it '5000 m'. Place the new mark at the zero or thousands mark until the A mark fits within the sub-divided thousands bar. Add the total of that distance to the 5000 m and that will be the total distance.

Measuring Along a Route

Sometimes cadets need to find the distance between A and B around curves in a road or along a planned route.

To measure a distance along a route between two points:

1. lay the straight edge of a piece of paper against point A;
2. with a sharp pencil, mark point A on the paper and the map;
3. line up the paper with the edge of the road until you come to a curve and make another mark on the paper and on the map;
4. pivot the paper so that it continues to follow the road edge. Repeat until you reach point B;
5. mark your paper and the map at point B;
6. lay the paper just under the scale bar (metres) and move the B mark backwards to each thousands mark until the A mark falls within the sub-divided thousands to the left of the zero; and
7. add the number of thousands where the B mark is, plus the number of sub-divided thousands where the A mark is to the left of the zero, will determine the total distance.

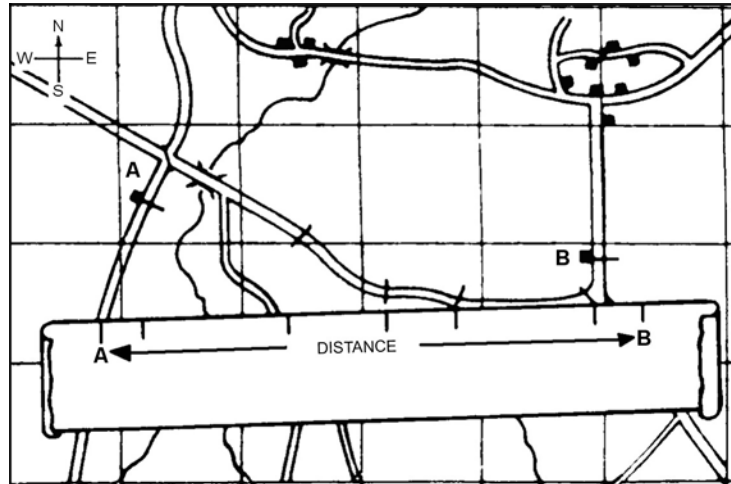


Figure 3 Measure Distance Along a Route

A-CR-CCP-121/PT-001 (p. 5-25)

CONFIRMATION OF TEACHING POINT 1

QUESTIONS

- Q1. What are the two methods of measuring distance on a map?
- Q2. What is the distance on the ground, for every cm measured on a 1:50 000 scale map?
- Q3. What scale bar must be used when calculating the distance measured?

ANTICIPATED ANSWERS

- A1. The two methods are point to point and along a route.
- A2. One cm on the map equals 50 000 cm (500 m) on the ground.
- A3. The metres scale bar is used when calculating distance.

Teaching Point 2

Explain, Demonstrate and Have Cadets Practice Determining Distance Using Individual Pacing

Time: 40 min

Method: Demonstration and Performance



On a pre-measured 100 m course, arrange the cadets so they can see a demonstration and hear the explanation of individual pacing.

PACE COUNTING METHOD

The pace counting method (pacing) is used for measuring a given distance by counting every other step. Two steps equal one pace. Pacing is a very important skill in navigation, as each person has a different pace and needs to establish their pace before it can become a useful measurement tool. Pacing varies between individuals as it uses a natural stride – an average adult will pace about 60 to 70 paces in 100 m.

To determine an individual pace, practice taking uniform, comfortable steps over a measured distance (100 m) counting every second step of the dominant foot. Do this three to five times to get an average. This will be the individual's pace number and should be remembered.

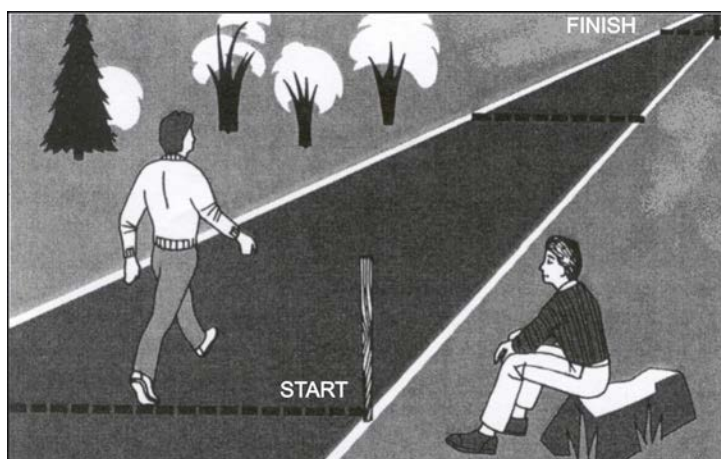


Figure 4 Determining Distance Using Pacing

Kjellstrom, B., Be Expert With Map & Compass, Hungry Minds, Inc. (p. 53)



Remember, pacing is an approximation. A margin of error of 1–2 percent is considered reasonable (e.g. 10-20 m for every one km walked).

ACTIVITY

Time: 30 min

OBJECTIVE

The objective of this activity is to have cadets determine an individual pace.

RESOURCES

- Pre-measured 100 m, and
- Pen and paper.

ACTIVITY LAYOUT

Have defined start and finish lines clearly marked.

ACTIVITY INSTRUCTIONS

- Have the cadets start at one end of the course and pace to the other end.
- Have the cadets record their paces after each length of the course.
- After three to five lengths (approx. 25 min), have the cadets calculate the average of their pace (total paces divided by the number of times they paced).

SAFETY

N/A.

CONFIRMATION OF TEACHING POINT 2

QUESTIONS

- Q1. What is pacing used to measure?
- Q2. How many steps equal one pace?
- Q3. What foot should be used to count paces?

ANTICIPATED ANSWERS

- A1. It is used to measure distance.
- A2. Two steps equal one pace.
- A3. The dominant foot should be used to count paces.

Teaching Point 3

Discuss Factors That Affect Pacing

Time: 15 min

Method: Interactive Lecture



Have cadets draw on personal experience to identify the factors that affect pacing.

FACTORS AFFECTING PACING

Pacing can be affected by different factors and numbers may vary. Some of the factors and the affect on individual pacing are:

- **Topography.** This is the most common factor. Walking through mud, thick bush and tall vegetation can shorten the paces.
- **Slopes.** Walking uphill will shorten the paces, while walking downhill can lengthen the paces.
- **Fatigue.** Pacing may change from natural in the morning, when cadets are rested, and shorter in the afternoon as they start to get tired.
- **Equipment.** Equipment could affect pacing, such as the wrong type of footwear. Too much or too little clothing and the amount of equipment being carried can shorten the paces.
- **Weather.** Heavy rain, wind velocity, temperature and snow can shorten the paces.



Pacing beads can be used to keep track of the distance walked. One bead is moved for every 100 m walked. If pacing beads are not available, stones can be used by moving them from one pocket to another to count every 100 m.

CONFIRMATION OF TEACHING POINT 3**QUESTIONS**

- Q1. What is the most common factor affecting pacing?
- Q2. What effect does walking downhill have on pacing?
- Q3. How can fatigue affect pacing from morning to afternoon?

ANTICIPATED ANSWERS

- A1. The most common factor affecting pacing is topography.
- A2. Walking downhill will make the paces longer.
- A3. Pacing will be natural in the morning and shorter in the afternoon.

END OF LESSON CONFIRMATION

The cadets' participation in the pacing activity will serve as the confirmation of this lesson.

CONCLUSION

HOMEWORK/READING/PRACTICE

N/A.

METHOD OF EVALUATION

N/A.

CLOSING STATEMENT

Being able to determine distance along a route is an important aspect of navigation training as it allows cadets to have an idea of distance travelled, distance to be travelled and a general sense of their location at all times while navigating.

INSTRUCTOR NOTES/REMARKS

N/A.

REFERENCES

A2-041 B-GL-382-005/PT-001 Canadian Forces. (2006). *Maps, Field Sketching, Compasses and the Global Positioning System*. Ottawa, ON: Department of National Defence.

C0-011 Canadian Orienteering Federation. (1985). *Orienteering Level Two Coaching Certification*. Ottawa, ON: Canadian Orienteering Federation.

C2-041 (ISBN 0-07-136110-3) Seidman, D. and Cleveland, P. (1995). *The Essential Wilderness Navigator*. Camden, ME: Ragged Mountain Press.

C2-045 (ISBN 1-4018-0961-8) Ford, H.L. (2003). *Landscape Surveying*. Florence, KY: Thomas Delmar Learning.

THIS PAGE INTENTIONALLY LEFT BLANK



ROYAL CANADIAN ARMY CADETS

RED STAR

INSTRUCTIONAL GUIDE



SECTION 5

EO M222.05 – ORIENT A MAP USING A COMPASS

Total Time:

30 min

PREPARATION

PRE-LESSON INSTRUCTIONS

Resources needed for the delivery of this lesson are listed in the lesson specification located in A-CR-CCP-702/PG-001, Chapter 4. Specific uses for said resources are identified throughout the Instructional Guide within the TP for which they are required.

Review the lesson content and become familiar with the material prior to delivering the lesson.

Calculate the declination for the map being used prior to delivering this lesson.

PRE-LESSON ASSIGNMENT

N/A.

APPROACH

Demonstration and performance was chosen for this lesson as it allows the instructor to explain and demonstrate orienting a map using a compass while providing an opportunity for the cadets to practice this skill under the supervision of an instructor.

INTRODUCTION

REVIEW

The review for this lesson is from EO M222.04 (Determine Distance Along a Route).

QUESTIONS

- Q1. What are the two methods of measuring distance on a map?
- Q2. How many steps equal one pace?
- Q3. What is the most common factor affecting pacing?

ANTICIPATED ANSWERS

- A1. Point to point and along a route.
- A2. Two steps equal one pace.
- A3. Topography.

OBJECTIVES

By the end of this lesson the cadet shall be expected to orient a map using a compass.

IMPORTANCE

It is important for cadets to know how to orient a map using a compass so they can accurately align features found on the map with true north when navigating a long distance.

Teaching Point 1

Explain, Demonstrate and Have Cadets Practice Orienting a Map Using a Compass

Time: 25 min

Method: Demonstration and Performance



Arrange the cadets so they can see the demonstration and hear the explanation of orienting a map using a compass as listed below.

As previously taught during Green Star navigation, orienting a map by inspection means turning the map so that, visually, the map directions and map detail correspond with details on the ground. When you are unable to identify details on the map with those on the ground (e.g. you are in a hilly area), or you need to orient the map more accurately when navigating a long distance, a compass must be used.



Figure 1 Set Declination

*D Cdts 3, 2007, Ottawa, ON:
Department of National Defence*



Figure 2 Set Compass to 00

*D Cdts 3, 2007, Ottawa, ON:
Department of National Defence*



Figure 3 Red in the Bed

*D Cdts 3, 2007, Ottawa, ON:
Department of National Defence*



For this skill lesson, it is recommended that instruction take the following format:

1. Explain and demonstrate the complete skill while cadets observe.
2. Explain and demonstrate each step required to complete the skill. Monitor cadets as they imitate each step.
3. Monitor the cadets' performance as they practice the complete skill.

Note: Assistant instructors may be employed to monitor cadet performance.

To orient a map using a compass:

1. set the current declination on the compass;
2. set the compass dial to read 00 (zero) mils or 0 degrees (north);
3. lay the compass flat on the map with the cover open;
4. point the mirror to North (top of the map);
5. align one side of the base plate with an easting line; and
6. turn the map and compass together until the red end of the magnetic needle is over the orienting arrow.



The mnemonic used to remember putting the magnetic needle over the orienting arrow is "Red in the Bed".

CONFIRMATION OF TEACHING POINT 1

QUESTIONS

- Q1. When would you orient a map by compass instead of by inspection?
- Q2. What number is the compass dial set to read?
- Q3. What is the mnemonic for putting the magnetic needle over the orienting arrow?

ANTICIPATED ANSWERS

- A1. When unable to identify details on the map or a more precise oriented map is required.
- A2. The compass dial is set to 00 mils or 0 degrees.
- A3. Put red in the bed.

END OF LESSON CONFIRMATION

QUESTIONS

- Q1. What is the first step to orienting a map using a compass?
- Q2. What direction is the compass mirror to be pointed on the map?
- Q3. How is the map aligned with the compass?

ANTICIPATED ANSWERS

- A1. Set the declination on the compass.
- A2. It is to be pointed to the top of the map or north.
- A3. Line up one side of the compass base plate with an easting line.

CONCLUSION

HOMEWORK/READING/PRACTICE

N/A.

METHOD OF EVALUATION

N/A.

CLOSING STATEMENT

Knowing how to orient a map using a compass is important as it enables you to accurately align the map with true north. It also aids cadets in having a general idea of their location during expedition training.

INSTRUCTOR NOTES/REMARKS

This lesson will be conducted with PO M223 (Participate in a Two Day Hike with Some Class 2 Terrain and Obstacles).

REFERENCES

A2-041 B-GL-382-005/PT-001 Canadian Forces. (2006). *Maps, Field Sketching, Compasses and the Global Positioning System*. Ottawa, ON: Department of National Defence.



ROYAL CANADIAN ARMY CADETS

RED STAR

INSTRUCTIONAL GUIDE



SECTION 6

EO M222.06 – FOLLOW A MAGNETIC BEARING POINT TO POINT

Total Time:

60 min

PREPARATION

PRE-LESSON INSTRUCTIONS

Resources needed for the delivery of this lesson are listed in the lesson specification located in A-CR-CCP-702/PG-001, Chapter 4. Specific uses for said resources are identified throughout the Instructional Guide within the TP for which they are required.

Review the lesson content and become familiar with the material prior to delivering the lesson.

Prior to this lesson, using a topographical map, prepare a navigation route, consisting of a minimum of six legs no greater than 100 m apart.

PRE-LESSON ASSIGNMENT

N/A.

APPROACH

Demonstration and performance was chosen for TP1 and TP2 as it allows the instructor to explain and demonstrate following a magnetic bearing point to point while providing an opportunity for the cadets to practice following a bearing point to point under supervision.

A practical activity was chosen for TP3 as it is an interactive way to allow cadets to experience following a magnetic bearing point to point in a safe, controlled environment. This activity contributes to the development of navigation skills and knowledge in a fun and challenging setting.

INTRODUCTION

REVIEW

The review for this lesson is from EO M222.05 (Orient a Map Using a Compass).

QUESTIONS

- Q1. What is the first step to orienting a map using a compass?
- Q2. What direction is the compass mirror to be pointed on the map?
- Q3. How are the map and compass aligned together?

ANTICIPATED ANSWERS

- A1. Set the declination on the compass.
- A2. The top of the map or north.
- A3. Line up one side of the compass base plate with an easting line.

OBJECTIVES

By the end of this lesson the cadet shall be expected to follow a magnetic bearing point to point.

IMPORTANCE

It is important for cadets to know how to determine the magnetic bearing of a prominent object, take a magnetic bearing on a map and follow a magnetic bearing so they will be able to navigate a route during orienteering and expedition training.

Teaching Point 1

Practice Determining the Magnetic Bearing of a Prominent Object

Time: 10 min

Method: Demonstration and Performance



Divide cadets into equal groups according to the number of compasses available. Arrange the cadets so they can see the demonstration and hear the explanation of determining the magnetic bearing of a prominent object as listed below.

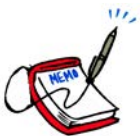
A compass can be used to identify the cardinal points such as north and south, the direction of travel and the bearing from one's current location to a prominent object. However, the ability to take a magnetic bearing of a prominent object and to use that information to help identify one's general location can save hours when trekking. A magnetic bearing is a quick method for describing the direction of travel.



To build navigation skills, it is useful to have cadets approximate their bearings prior to taking a bearing with the compass.



A prominent object is something that is large and easily seen (e.g. church or hilltop).



For this skill lesson, it is recommended that instruction take the following format:

1. Explain and demonstrate the complete skill while cadets observe.
2. Explain and demonstrate each step required to complete the skill. Monitor cadets as they imitate each step.
3. Monitor the cadets' performance as they practice the complete skill.

Note: Assistant instructors may be employed to monitor cadet performance.



Figure 1 Determining a Magnetic Bearing

A-CR-CCP-121/PT-001 (p. 5-42)

To determine the magnetic bearing of a prominent object:

1. Check and set the pre-determined declination on the compass.
2. Hold the compass at eye level, at arms length, and face the prominent object.
3. Aim at the object using the compass sight, ensuring the sighting line is in line with the index pointer.
4. Adjust the compass cover so the compass dial is seen in the sighting mirror.
5. Look in the mirror and turn the compass dial until the magnetic needle is over the orienting arrow (red in the bed).
6. Read the number on the compass dial at the luminous index pointer. The magnetic bearing of the prominent object is read at the luminous index pointer.

CONFIRMATION OF TEACHING POINT 1

QUESTIONS

- Q1. What is a magnetic bearing?
- Q2. Where must the magnetic needle be when looking in the mirror and turning the compass dial?
- Q3. From where is the magnetic bearing of the prominent object read?

ANTICIPATED ANSWERS

- A1. A magnetic bearing is a bearing that is measured between two points using a compass.
- A2. The magnetic needle must be over the orienting arrow (red in the bed).
- A3. The magnetic bearing is read from the luminous index pointer.

Teaching Point 2**Explain, Demonstrate and Have the Cadets Practice Taking a Magnetic Bearing on a Map**

Time: 15 min

Method: Demonstration and Performance

The ability to measure a bearing from a map allows cadets to plan routes or activities before going into the field, and allows an easy method of communicating information about movement or location. When a compass is adjusted to compensate for declination, it will provide the equivalent of a magnetic bearing. Magnetic bearings may be set on the compass without further conversions.



For this skill lesson, it is recommended that instruction take the following format:

1. Explain and demonstrate the complete skill while cadets observe.
2. Explain and demonstrate each step required to complete the skill. Monitor cadets as they imitate each step.
3. Monitor the cadets' performance as they practice the complete skill.

Note: Assistant instructors may be employed to monitor cadet performance.



Figure 2 Measuring a Magnetic Bearing on a Map
D Cds 3, 2007, Ottawa, ON: Department of National Defence

To measure a magnetic bearing on a map:



Prior to measuring a magnetic bearing on a map it is good practice to first estimate the bearing by drawing a quick compass rose and looking at where the bearing would be on the compass rose. This serves as a good check to ensure the cadet has not accidentally measured the back bearing.

1. Set the pre-determined declination on the compass.
2. Identify and mark the start (point A) and finish (point B) points on a map.
3. Draw a plotting ray from point A to point B.
4. Lay the fully opened compass with the edge of the compass base plate along the plotting ray, in the direction of travel (point A to point B).
5. Hold the compass in place, rotate the compass dial so that the compass meridian lines align with the easting lines on the map, ensuring north on the dial indicates north on the map.
6. Read the number on the compass dial at the luminous index pointer.

The magnetic bearing is read at the luminous index pointer.



If the bearing is taken from point B to point A, the compass will be pointing 180 degrees or 3200 mils in the exact opposite direction of travel wanted. This is also called a back bearing.

CONFIRMATION OF TEACHING POINT 2

QUESTIONS

- Q1. What is the first step to measuring a magnetic bearing on a map?
- Q2. What direction along the plotting ray must the compass be laid?
- Q3. With what lines on the map must the compass meridian lines align?

ANTICIPATED ANSWERS

- A1. Setting the pre-determined declination on the compass.
- A2. In the direction of travel – point A to point B.
- A3. The compass meridian lines must align with the map easting lines.

Teaching Point 3**Follow a Magnetic Bearing Point to Point**

Time: 25 min

Method: Practical Activity

ACTIVITY**OBJECTIVE**

The objective of this activity is to have cadets follow a magnetic bearing point to point.

RESOURCES

- Topographical map (one per group), and
- Compass (one per group).

ACTIVITY LAYOUT

Navigation route consisting of a minimum of six legs, no greater than 100 m apart in distance.

ACTIVITY INSTRUCTIONS

1. Divide cadets in groups of four to six.
2. Issue each group with a map and compass.
3. Have a different cadet in each group take a magnetic bearing on a map during daylight.
4. Have each cadet take a turn leading the group, while following a magnetic bearing point to point.

SAFETY

N/A.

CONFIRMATION OF TEACHING POINT 3

The cadets' participation in following a magnetic bearing point to point will serve as the confirmation of this TP.

END OF LESSON CONFIRMATION**QUESTIONS**

- Q1. What is the definition of a prominent object?
- Q2. What is the definition of a magnetic bearing?
- Q3. What numbers indicate the magnetic bearing?

ANTICIPATED ANSWERS

- A1. A prominent object is something that is large and easily seen (e.g. church or hilltop).
- A2. A magnetic bearing is a bearing that is measured between two points using a magnetic compass.
- A3. The numbers shown at the luminous index pointer indicate the magnetic bearing.

CONCLUSION

HOMEWORK/READING/PRACTICE

N/A.

METHOD OF EVALUATION

N/A.

CLOSING STATEMENT

Being able to determine the magnetic bearing of a prominent object, take a magnetic bearing on a map and follow a magnetic bearing will assist the cadets in navigating a route during orienteering and expedition training.

INSTRUCTOR NOTES/REMARKS

N/A.

REFERENCES

A2-041 B-GL-382-005/PT-001 Canadian Forces. (2006). *Maps, Field Sketching, Compasses and the Global Positioning System*. Ottawa, ON: Department of National Defence.

THIS PAGE INTENTIONALLY LEFT BLANK



ROYAL CANADIAN ARMY CADETS

RED STAR

INSTRUCTIONAL GUIDE



SECTION 7

EO C222.01 – PRACTICE NAVIGATION USING A MAP AND COMPASS

Total Time:

90 min

PREPARATION

PRE-LESSON INSTRUCTIONS

Resources needed for the delivery of this lesson are listed in the lesson specification located in A-CR-CCP-702/PG-001, Chapter 4. Specific uses for said resources are identified throughout the Instructional Guide within the TP for which they are required.

Review the lesson content and become familiar with the material prior to delivering the lesson.

Review the activities in TP2 to confirm local resources required and prepare the route to be used to include GRs and bearings.

If assistant instructors are not available, determine a safety bearing to a known location.

Prepare brain teaser clues/puzzle navigation pieces (word, picture or phrase) for each checkpoint.

PRE-LESSON ASSIGNMENT

N/A.

APPROACH

An interactive lecture was chosen for TP1 to give direction on procedures and to illustrate the application of rules for the navigation exercise.

A practical activity was chosen for TP2 as it is an interactive way to allow cadets to experience navigation in a safe, controlled environment. This activity contributes to physical fitness and to the development of navigation skills and knowledge in a fun and challenging setting.

A group discussion was chosen for TP3 as it allows the cadets to interact with their peers and share their knowledge, experiences, opinions, and feelings about navigation training.

INTRODUCTION

REVIEW

N/A.

OBJECTIVES

By the end of this lesson the cadet shall have practiced navigation using a map and compass.

IMPORTANCE

It is important for cadets to practice navigation using a map and compass as it is a skill set that must be practiced in order to build confidence and accuracy. Participation in these activities contributes to the development of navigation skills and knowledge in a fun and challenging setting. Cadets will rely on this skill set throughout navigation and expedition training.

Teaching Point 1

Conduct a Safety Briefing

Time: 10 min

Method: Interactive Lecture



Arrange the cadets so they can see any demonstrations and hear the safety briefing prior to participating in the activity.



This briefing is being conducted to pass on vital information and to answer any questions regarding the safe conduct of a navigation activity, to include:

- actions that can be taken if they become lost, may include:
 - returning to the previous checkpoint;
 - using a radio if available; or
 - following a safety bearing to a known location;
- a time limit for the activity of 55 minutes;
- boundaries set for the conduct of the activity;
- rules and safety procedures for the activity; and
- a narrative of the specific activity being conducted.

CONFIRMATION OF TEACHING POINT 1

QUESTIONS

- Q1. What actions shall be taken if a group becomes lost?
- Q2. What is the time limit for this activity?
- Q3. What are the boundaries for this activity?

ANTICIPATED ANSWERS

- A1. If a group becomes lost, they should return to the previous checkpoint or follow a safety bearing to a known location.
- A2. This activity will last no more than 55 minutes.
- A3. The answers to this question will vary based on the local area being used.

Teaching Point 2**Participate in a Navigation Activity**

Time: 55 min

Method: Practical Activity



Select one of the following activities to be conducted in the time allocated. If time permits, try more than one activity. Prepare for each activity in advance using resources available.

NAVIGATION BRAIN TEASER

Using a map and compass, cadets will navigate to a predetermined point on the map. The course will consist of a minimum of six legs, approximately 100 to 200 m in length. At each point the cadets will be given simple clues (magnetic bearing, GR, or distance) directing them to the next checkpoint. The team that locates the most checkpoints and has the fastest time is the winning team.

COMPASS WORK AND PACING

Using a map and compass, cadets will follow a predetermined bearing on the map. The course will consist of a minimum of six legs, approximately 100 to 200 m in length. Following the bearing provided, each team will determine the number of paces and distance between each checkpoint. The team with the most accurate measurements of distance between each checkpoint and the fastest time is the winning team.

PUZZLE NAVIGATION

Using a map and compass, cadets will navigate along a predetermined route. At each checkpoint on the route, cadets will collect a puzzle piece. The puzzle could be a picture, word or phrase. The first team to collect all puzzle pieces, cross the finish line and solve the puzzle is the winning team.



This sample word puzzle when unscrambled will spell "CADET":

- at checkpoint 1 the group collects a "D";
- at checkpoint 2 the group collects a "T";
- at checkpoint 3 the group collects a "A";
- at checkpoint 4 the group collects a "C";
- at checkpoint 5 the group collects a "E";



An example of a picture puzzle can be found at Annex A, to be completed as follows:

1. photocopy one picture for each team;
2. cut the picture into pieces equal to the number of checkpoints;
3. label each piece of the puzzle with the same team number;
4. at each checkpoint the group will collect the same numbered puzzle piece; and
5. at the end of the navigation the group will assemble the puzzle.

ACTIVITY 1

OBJECTIVE

The objective of the Navigation Brain Teaser activity is to have the cadets, as members of a team, participate in point to point navigation.

RESOURCES

- Topographical map (one per team);
- Compass (one per team); and
- A predetermined navigation route.

ACTIVITY LAYOUT

- Have defined start and finish lines clearly marked.
- Position a clue at each point directing groups to the next point.

ACTIVITY INSTRUCTIONS

1. Divide the cadets into groups of four to six.
2. Issue each group a map and compass.
3. Give the clue for the first checkpoint to the cadet leading the group.
4. Start groups at two-minute intervals and record start times.
5. On a sheet of paper, have cadets record each clue in the order they complete each checkpoint.
6. Collect sheets and record the finish time for each group.



If available, use an assistant instructor at each checkpoint to give cadets the next clue, answer questions and to prevent groups from following each other or sharing answers.

SAFETY

N/A.

ACTIVITY 2

OBJECTIVE

The objective of the Compass Work and Pacing activity is to have cadets, as members of a team, participate in pacing and determining distance during navigation.

RESOURCES

- Topographical map (one per team);
- Compass (one per team); and
- A predetermined pacing/navigation route.

ACTIVITY LAYOUT

Have defined start and finish lines clearly marked.

ACTIVITY INSTRUCTIONS

1. Divide the cadets into groups of four to six.
2. Issue each group a map and compass.
3. Have cadets transfer the course to be followed onto the maps.
4. Start groups at two-minute intervals and record start times.
5. On a sheet of paper, have cadets record paces and distance for each leg they complete.
6. Collect sheets and record the finish time for each group.



If available, use an assistant instructor at each checkpoint to answer questions and to prevent groups from following each other or sharing answers.

SAFETY

N/A.

ACTIVITY 3
OBJECTIVE

The objective of the Puzzle Navigation activity is to have the cadets, as members of a team, participate in point to point navigation.

RESOURCES

- Topographical map (one per team);
- Compass (one per team);
- Puzzle pieces (one per team, per checkpoint); and
- A predetermined navigation route.

ACTIVITY LAYOUT

- Have defined start and finish lines clearly marked.
- Position identical puzzle pieces at each checkpoint.

ACTIVITY INSTRUCTIONS

1. Divide the cadets into groups of four to six.
2. Issue each group a map and compass.
3. Start groups at two-minute intervals and record start times.
4. Have the cadets collect one piece of the puzzle from each checkpoint.
5. Once across the finish line, cadets will solve the puzzle and give the answer to the instructor.



If available, use an assistant instructor at each checkpoint to give cadets the puzzle piece, to answer questions and to prevent groups from following each other or sharing answers.

SAFETY

N/A.

CONFIRMATION OF TEACHING POINT 2

The cadets' participation in the navigation activities will serve as the confirmation of this TP.

Teaching Point 3**Conduct a Debriefing**

Time: 15 min

Method: Group Discussion

GROUP DISCUSSION**TIPS FOR ANSWERING/FACILITATING DISCUSSION**

- Establish ground rules for discussion, e.g. everyone should listen respectfully; don't interrupt; only one person speaks at a time; no one's ideas should be made fun of; you can disagree with ideas but not with the person; try to understand others as much as you hope they understand you; etc.
- Sit the group in a circle, making sure all cadets can be seen by everyone else.
- Ask questions that will provoke thought; in other words avoid questions with yes or no answers.
- Manage time by ensuring the cadets stay on topic.
- Listen and respond in a way that indicates you have heard and understood the cadet. This can be done by paraphrasing their ideas.
- Give the cadets time to respond to your questions.
- Ensure every cadet has an opportunity to participate. One option is to go around the group and have each cadet answer the question with a short answer. Cadets must also have the option to pass if they wish.
- Additional questions should be prepared ahead of time.

SUGGESTED QUESTIONS

- Q1. What navigation skills were required to complete the activity?
- Q2. What was the hardest part of the activity to complete?
- Q3. What was the most exciting part of this activity?
- Q4. How will the activity help you with navigation in the future?



Other questions and answers will develop throughout the group discussion. The group discussion should not be limited to only those suggested.



Reinforce those answers given and comments made during the group discussion, ensuring the teaching point has been covered.

CONFIRMATION OF TEACHING POINT 3

The cadets' participation in the group discussion will serve as the confirmation of this TP.

END OF LESSON CONFIRMATION

The cadets' participation in the navigation activities as well as the group discussion will serve as the confirmation of this lesson.

CONCLUSION

HOMEWORK/READING/PRACTICE

N/A.

METHOD OF EVALUATION

N/A.

CLOSING STATEMENT

Navigation using a map and compass is a skill that can also be used in situations outside the Cadet Program. True proficiency in the skill used during these activities can only be achieved by practicing. These activities allow the cadets the opportunity to develop their navigation skills and knowledge in a fun and challenging setting.

INSTRUCTOR NOTES/REMARKS

The intent of this activity is to give the cadet experience navigating with a map and compass, determining distance and following a bearing from point to point.

This activity may be conducted using any available map (topographical, orienteering or locally produced).

REFERENCES

A2-041 B-GL-382-005/PT-001 Canadian Forces. (2006). *Maps, Field Sketching, Compasses and the Global Positioning System*. Ottawa, ON: Department of National Defence.

PUZZLE NAVIGATION



Figure A-1 Puzzle Navigation

D Cdts, 2007, Ottawa, ON: Department of National Defence

THIS PAGE INTENTIONALLY LEFT BLANK



ROYAL CANADIAN ARMY CADETS

RED STAR

INSTRUCTIONAL GUIDE



SECTION 1

EO M223.01 – PREPARE FOR TREKKING

Total Time:

60 min

PREPARATION

PRE-LESSON INSTRUCTIONS

Resources needed for the delivery of this lesson are listed in the lesson specification located in A-CR-CCP-702/PG-001, Chapter 4. Specific uses for said resources are identified throughout the Instructional Guide within the TP for which they are required.

Review the lesson content and become familiar with the material prior to delivering the lesson.

Review EO M123.01 (Select Trekking Gear) to prepare for the activity in TP1.

Review the activity for TP1 and set up the classroom as per the activity instructions.

Photocopy the handouts at Annexes A, B and D for each cadet. Prepare the cards at Annex A for the activity in TP1.

PRE-LESSON ASSIGNMENT

N/A.

APPROACH

An in-class activity was chosen for TP1 and TP2 as it is an interactive way to present a personal kit list.

An interactive lecture was chosen for TP3 and TP4 to introduce preparing for a trek.

INTRODUCTION

REVIEW

N/A.

OBJECTIVES

By the end of this lesson the cadet shall be expected to prepare a personal kit list and physically prepare before a trek.

IMPORTANCE

It is important for cadets to know how to organize and prepare for a trek – selecting trekking gear, creating an important item lists and identifying the physical demands of a trek. Trekking is one component of expeditions. By being prepared for such an activity, cadets will be better equipped to meet the mental and physical challenges of an expedition.

Teaching Point 1**Conduct an Activity on Trekking Gear**

Time: 15 min

Method: In-Class Activity

ACTIVITY**OBJECTIVE**

The objective of this activity is to review the characteristics of trekking gear.

RESOURCES

For this activity, it is recommended to have two cadets help monitor the game.

- Pre-cut trekking gear cards located at Annex A (one set per team);
- Flip chart paper (one sheet per team); and
- Tape.

ACTIVITY LAYOUT

Set up two flipchart sheets side by side labelled Team A and Team B.

ACTIVITY INSTRUCTIONS

1. Divide the cadets into two teams.
2. Have each team line up in front of their flipchart sheet.
3. The first cadet on each team will draw a trekking gear card.
4. Have the cadet read the characteristics on the card to their team. The team must guess what item the card is describing.
5. When the team guesses the item correctly, the cadet will go and post the card on the team's flipchart sheet.
6. The rest of the team (one after the other) will draw a card and repeat steps 4 and 5.
7. The first team that has all their cards posted, wins and can go on a trek.

SAFETY

N/A.

CONFIRMATION OF TEACHING POINT 1

The cadet's participation in the activity will serve as the confirmation of this TP.

Teaching Point 2**Conduct an Activity to Identify Permanent Items and a Personal Kit List**

Time: 15 min

Method: In-Class Activity

Before going on a trek, it is essential that no extra equipment is carried. Avoid over packing to reduce the weight of the backpack. A checklist is a good way of keeping track of what is needed. After each trek, the list should be amended to reflect what was used and in what quantity in order to be prepared for the next time.

Before going on a trek, the following considerations will help when making a checklist:

- the distance (long distance treks determine the equipment one should bring);
- the type of terrain;
- the weather forecast; and
- the cadet's interests (photography, rock climbing, etc.).



Raingear and a first aid kit should always be part of your kit list.

PERMANENT ITEMS LIST

Personal Items. A personal items list will not change much from trek to trek. The following should be part of the list:

- personal hygiene kit (toothbrush and paste, biodegradable soap, razor, comb or brush, towel, toilet paper and women's sanitary supplies);
- personal medication;
- insect repellent;
- lip balm;
- cookware and utensils;
- pen and paper (notebook); and
- money.

Six Essential Items. The following items can be used to avoid difficult situations and prepare for the unexpected:

- a pocket knife or multi-tool;
- a water container;
- extra food (energy bars, dried fruit or nuts, hard candies, etc.);
- extra clothing (warm clothing and raingear);
- sunscreen and sunglasses; and

- a survival kit, to include:
 - a water filter;
 - a flashlight;
 - waterproof matches;
 - a signalling device (e.g. whistle and mirror); and
 - a first aid kit.



It is a good idea to layout all equipment before packing it. It allows the person to see what is there and if something is missing.

It is also a good way to see which items need to be put in plastic bags to keep them dry.

Last Minute Checklist. A checklist of things to do before a trek should always be kept up to date. The following should be considered:

- Fill water containers.
- Check equipment (cooking devices, boots, review the six essential items).
- Check for an updated weather forecast.
- Check trail conditions with local management or park office.



It is always a good idea to:

- make copies of the itinerary and leave one with local land management or the park office; and
- tell a reliable friend of the itinerary and what to do and who to contact if one does not return as scheduled.

ACTIVITY

Time: 10 min

OBJECTIVE

The objective of this activity is to identify items to include in a personal items list based on a weather forecast.

RESOURCES

- Pen; and
- Answer sheet and scenarios located at Annex B.

ACTIVITY LAYOUT

N/A.

ACTIVITY INSTRUCTIONS

1. Divide the cadets into groups of four.
2. Distribute one scenario (located at Annex B) to each group. It is acceptable for more than one group to have the same scenario.
3. Have cadets select the equipment from the list that they would take on a trek depending on the weather forecast on their sheet.
4. Give them five minutes to identify their items. Review the answers as a group. If there is a mistake, explain why it is not the best choice. The answer key is located at Annex C.

SAFETY

N/A.

CONFIRMATION OF TEACHING POINT 2**QUESTIONS**

- Q1. What are some considerations that help a cadet make a checklist?
- Q2. Name three items that fall under a permanent list.
- Q3. Name three items that fall under the six essential list.

ANTICIPATED ANSWERS

- A1. Some considerations are the distance, the type of terrain, the weather forecast and the cadet's interest.
- A2. Personal hygiene kit, personal medication, insect repellent, lip balm, cookware and utensils, pen, paper or notebook and money are items that fall under the permanent list.
- A3. Pocket knife or multi-tool, water container, water filter, flashlight, extra food, extra clothing, waterproof matches, sunscreen, sunglasses, signalling device and first aid kit are items that fall under the six essential list.

Teaching Point 3**Discuss the Physical Demands of a Trek**

Time: 5 min

Method: Interactive Lecture

In order to facilitate the trek, one should have the physical strength to trek successfully. By working toward improving cardiovascular endurance, strength and balance, one should have fewer difficulties completing an all day trek.

Cardiovascular Endurance. Improving cardiovascular endurance means to strengthen the heart, lungs and leg muscles. It will enhance the body's ability to deliver larger amounts of oxygen to working muscles. By doing so, the muscles will develop a greater capacity to use oxygen and it will be easier to recover from the stress of exercise. It will also increase energy level and allow the cadet to hike longer on uneven terrain.

Strength. Improving strength means developing muscle tone. By doing so, endurance will increase. It will make a difference on the distance of the trek and when crossing obstacles with a backpack. Greater strength means the trekker will hike longer and, with little difficulty, across uneven terrain.

Balance. Improving balance means improving physical skills and increasing body control and awareness. It improves stability and helps avoid injuries. Good balance improves walking techniques on uneven terrain and helps when crossing obstacles.

CONFIRMATION OF TEACHING POINT 3

QUESTIONS

- Q1. What parts of the body are strengthened by cardiovascular activities?
- Q2. What does improving strength mean?
- Q3. What can you avoid if you improve your balance?

ANTICIPATED ANSWERS

- A1. Cardiovascular activities will strengthen the heart, lungs and leg muscles.
 - A2. Improving strength means developing muscle tone.
 - A3. You can avoid injuries.
-

Teaching Point 4

Discuss How to Physically Prepare for a Trek

Time: 15 min

Method: Interactive Lecture

EXERCISES TO BUILD BODY STRENGTH

Aerobic Exercises

It is recommended to improve cardiovascular endurance by practicing activities that one enjoys. Consistency is the key to success. Exercises should focus on increasing distance and duration as personal fitness improves. Exercises should be regular and well-balanced.



When increasing your cardiovascular and strength training activities, it is important to remember that pain is not an indicator of improvement.

To improve cardiovascular endurance, practice some of the following activities twice a week for at least 20 minutes:

- cycling (road or mountain biking);
- walking (on flat ground, briskly walk for a minimum of 40 minutes);
- going to the gym (stationary bike, cross trainer, rowing machine, etc.);
- running (progress from brisk walking to jog-walking to running);
- participating in classes (aerobics, step-aerobics, aqua-aerobics);
- swimming (lane swimming);
- playing any racquet sports;

- playing soccer; and
- any activities that use arms and legs causing the pulse to work at a minimum of 65% of one's maximum heart rate.

In order to keep interest, a person should vary their aerobic activities.



Remember, being active is easy to achieve without spending money or a great deal of time organizing an activity.

Strength Building Exercises



For this part, demonstrations may be performed by the instructor or an assistant instructor.

Distribute the handout, located at Annex D, to the cadets.

Explain to the cadets that if at any point these exercises hurt the body or become difficult, they should stop immediately.



For all weight exercises, weights should be conducive to fitness level. It should start with one pound and progress with the fitness level. Cadets do not have to buy a set of hand weights. They can use any objects with a handle (milk jug, soft drink or water bottle filled with sand or water).

Any "homemade" weights need to be weighed to ensure the pair are the same.



With any weight training, cadets should remember to:

- Control their movements in order to avoid swinging the weights.
- Avoid using the momentum to lift the weights.
- Stop any exercises that hurt or do not feel right.

LEGS

Abductor Raise. Lie on the floor on the left side with the left leg slightly bent. Use the left hand to support the head and place the right hand in front for support. Keeping the right leg straight and in line with the body, raise it with a slow, controlled movement. Hold for one second, lower and then repeat. This exercise should be repeated a minimum of 10 times on both sides.



Figure 1 Abductor Raise

Yahoo Health, 2007, Basic Muscle-conditioning Exercises, Copyright 2002 by Nucleus Communications Inc. Retrieved 29 March 2007, from <http://health.yahoo.com/topic/weightloss/overview/article/healthwise/popup/zm2427>

Lunge. Keep hands on sides with feet shoulder-width apart. Step forward with one leg, bending both knees until the thigh is parallel with the knee. Push back to the starting position. Alternate legs. Do not let the knee touch the ground. This exercise should be repeated a minimum of 10 times on both sides.



Figure 2 Lunges With Weights

Department of Public Health County of Los Angeles California, 2006, LAPublicHealth.org/Strength Training, Copyright 2006 by LADPH. Retrieved 27 March 2007, from <http://www.lapublichealth.org/physact/physactstrength.htm>

Glutes Raise. Support body weight on the elbows and knees with hands together in front. The back should stay straight. Keeping the right leg bent, raise it into the air. Press up into the heel. Count two seconds up and two seconds down. This exercise should be repeated a minimum of 10 times on both sides.



Figure 3 Glutes Raise

Bodybuilding.com, 2007, Exercise Guides-Glute Kickback, Copyright 2007 by Bodybuilding.com. Retrieved 29 March 2007, from <http://bodybuilding.com/fun/exercises.php?mainmuscle=glute>

ARMS

Pushups. Place hands directly under the shoulders, keeping fingers pointed forward and legs in line with the body. Lower the body toward the floor without touching it and then push off the floor to the start position. Do as many as you can.

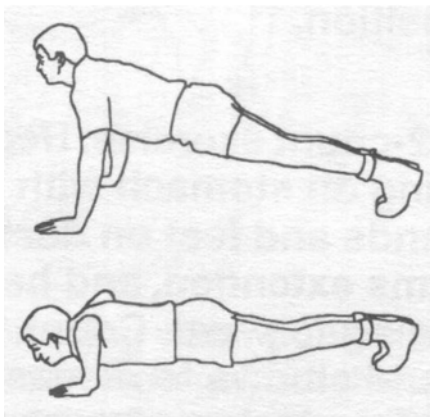


Figure 4 Push Up

The Fitness Motivator.com, 2006, Add these Basic Exercises to your fitness plan. Retrieved on 29 March 2007, from <http://www.the-fitness-motivator.com/basicexercises.html>

BACK AND SHOULDERS

Lateral Raise With Weights. Hold weights at the sides, palms facing in. Slowly raise arms to shoulder level and lower. Keep arms and wrists straight. This exercise should be repeated a minimum of 10 times on both sides.

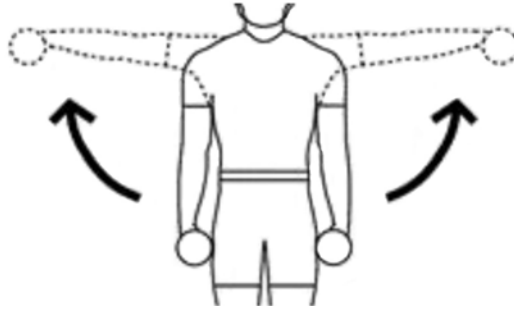


Figure 5 Lateral Raise With Weights

Weight Lifting Workout Routines, 2006, Shoulder Exercises, Copyright, 2006 by Weight Lifting Workout Routines. Retrieved 29 March 2007, from <http://www.weight-lifting-workout-routines.com/shoulder-exercises.html>

STOMACH

Crunches. Lie on the back bringing the legs up over the hips and cross the ankles. Place the arms either on the thighs, across the chest or beside the head (hardest). Pull stomach muscles in tight and then slowly curl up using abs to lift shoulders from the ground at the same time. Do not swing legs. This exercise should be repeated a minimum of 10 times for the left and right side. The number of repetitions can increase with comfort level.

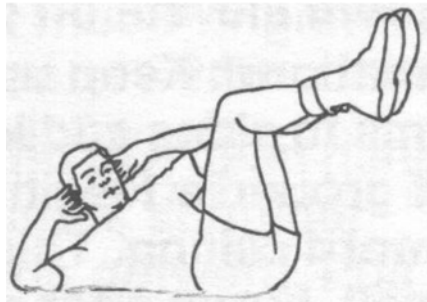



Figure 6 Crunches Position

The Fitness Motivator.com, 2006, Add these Basic Exercises to Your Fitness Plan. Retrieved on 3 April 2007, from <http://www.the-fitness-motivator.com/basicexercises.html>

STRETCHING EXERCISES BEFORE AND DURING THE TREK

The following exercises should be conducted before and after a trek. They will reduce stiffness of muscles and prevent any stress or possible injuries.



It is a good idea, during the trek, to use a few minutes of your rest breaks to stretch.

Warming up before a trek allows the muscles to loosen. Stretches should be executed slowly and smoothly. Bouncing exercises or forced stretches are not recommended.

Neck. Slowly roll the head across the chest from shoulder to shoulder. Do not roll head backwards. This exercise should be repeated 10 times.

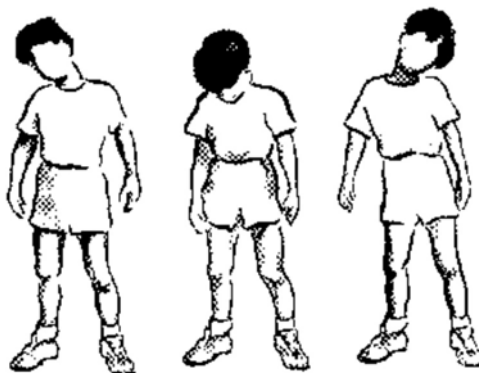


Figure 7 Neck Stretch

Moving on the Spot: A Collection of 5-Minute Stretch and Movement Sessions, by B. Hanson, 1999, Toronto, ON: Toronto Public Health. Retrieved 26 October 2006, from <http://www.lin.ca/resource/html/dn3.htm#1>

Shoulders. Stand and raise the top of the shoulders toward the ears until a slight tension in the neck and shoulders is felt. Hold for five seconds. Then relax shoulders downward. This exercise should be repeated a minimum of 10 times.



Figure 8 Shoulders Stretch

University of Michigan Occupational Safety and Environmental Health, 2007, Basic Office Stretches, Copyright 2007 by The Regents of the University of Michigan. Retrieved 28 March 2007, from http://www.oseh.unmich.edu/ergonomics_intro.html

Triceps and Top of Shoulders. Stand up and bring the right arm over the head, bent at the elbow. Use the left hand to gently pull the arm down. Hold this position for a minimum of 10 seconds. This exercise should be repeated a minimum of 10 times on both sides.



Figure 9 Triceps Stretch

Smart Start: A Flexible Way to Get Fit. Retrieved 26 October 2006, from <http://www.in-motion.ca/walkingworkout/plan/flexibility/>

Shoulders, Arms and Chest. Interlace fingers behind the back. If this feels fairly easy, then lift the arms up behind the back until a stretch is felt in the arms, shoulders, or chest. Hold for 10 to 15 seconds. Keep chest and chin out.



Figure 10 Shoulders, Arms and Chest Stretch

University of Michigan Occupational Safety and Environmental Health, 2007, Basic Office Stretches, Copyright 2007 by The Regents of the University of Michigan. Retrieved 28 March 2007, from http://www.oseh.unmich.edu/ergonomics_intro.html

Hamstrings, Back Knees and Legs. Stand with the feet shoulder-width apart and pointed straight ahead. Slowly bend forward from the hips. Keep the knees slightly bent. Go to the point where a slight stretch is felt in the back of your legs. Hold for 10 to 15 seconds.



Figure 11 Hamstring, Back Knees and Leg Stretch

PC Coach, 2005, Stretching for Runners, Copyright 2005 by Biometrics Inc. Retrieved on 29 March 2007, from <http://www.pccoach.com/newsletters/may05/stretching.htm>

Front Hip and Lower Back Area. Start with one leg in front of the other, with the ankle of the front leg directly below the front knee. The other knee is resting on the ground. Place the hands on top of each other on the thigh, just above the knee. Hold for 10 to 15 seconds and repeat for the other side.



Figure 12 Stretch for Hip and Lower Back Area

ARC Committed to Curing Arthritis, 2007, Back Pain, Copyright 2007 for Arthritis Research Campaign. Retrieved 27 March 2007, from http://www.arc.org.uk/about_arth/booklets/6002/6002

Quads and Knees. Hold the top of the right foot with the left hand and gently pull the heel toward the buttocks. The knee bends at a natural angle when holding the foot with the opposite hand. Hold for 10 to 15 seconds and repeat for the other leg.



Figure 13 Quads and Knees Stretch

Women's Heart Foundation, 2005, Stretching Exercises for Women, Copyright 2005 for Women's Heart Foundation. Retrieved 28 March 2007, from http://www.womensheart.org/content/exercises/stretching_exercises.asp

Squat. Squat down with feet flat and toes pointed out at 15 degrees. Heels should be apart depending on how flexible one is. Keep knees to the outside of the shoulders, directly above the big toes. Hold for 15 to 30 seconds. Using a fence or pole for balance is acceptable.



Figure 14 Squat Position

The Back Rack, 1999, Cycling Stretches After Riding, Copyright 1999 by Stretching Inc. Retrieved 29 March 2007, from <http://thebikerack.com/page.cfm?pageId=247>

Ankles. Lift the left foot off the ground and rotate the foot and ankle 10 to 15 times clockwise and then counterclockwise. Repeat for the right foot and ankle.



Figure 15 Ankle Rotation

Women's Heart Foundation, 2005, Stretching Exercises for Women, Copyright 2005 by Women's Heart Foundation. Retrieved 28 March 2007, from http://www.womensheart.org/content/exercises/stretching_exercises.asp

CONFIRMATION OF TEACHING POINT 4

QUESTIONS

- Q1. Name two aerobic activities that improve strength.
- Q2. Why is it important to stretch before, during and after a trek?
- Q3. If experiencing pain during a stretch, what should you do?

ANTICIPATED ANSWERS

- A1. Cycling, walking, running, aerobic classes, swimming, squash, soccer and any other activities that use arms and legs are all aerobics activities.
- A2. Stretching allows the muscles to warm up and loosen and will reduce stiffness in the muscles for the trekker. It will prevent any stress or possible injuries.
- A3. Stop the stretch and ask for help.

END OF LESSON CONFIRMATION

QUESTIONS

- Q1. What can you do to improve your cardiovascular endurance?
- Q2. Name the exercise that can improve your back/shoulders strength.
- Q3. Why should you stretch before, during and after the trek?

ANTICIPATED ANSWERS

- A1. Practice favourite activities such as cycling, walking, gym, running, classes, swimming, squash, soccer or any other activities that use arms and legs.
- A2. It is the lateral raise with weights.
- A3. Stretching allows the muscles to warm up and loosen while reducing stiffness in the muscles for the trekker and preventing any stress or possible injuries.

CONCLUSION

HOMEWORK/READING/PRACTICE

N/A.

METHOD OF EVALUATION

N/A.

CLOSING STATEMENT

Knowing how to prepare for a trek may save time and prevent difficult experiences. It is imperative for cadets to be prepared before leaving for a trek as it may make the trip easier and more enjoyable for everyone.

INSTRUCTOR NOTES/REMARKS

For the activity in TP1, trekking equipment may be borrowed. Some sponsors may be able to provide a deposit so that some outdoor stores will loan outdoor equipment. This activity may also be conducted in an outdoor store.

A hand out on the exercises and stretches is located at Annex D.

REFERENCES

C0-089 (ISBN 0-936070-22-6) Anderson, B. (2000). *Stretching 20th Anniversary* (Rev. ed.). Bolinas, CA: Shelter Publications Inc.

C2-016 (ISBN 0-517-88783-5) Curtis, R. (1998). *The Backpacker's Field Manual: A Comprehensive Guide to Mastering Backcountry Skills*. New York, NY: Three Rivers Press.

C2-017 (ISBN 0-7627-0476-4) Roberts, H. (1999). *Basic Essentials, Backpacking*. Guilford, CT: The Globe Pequot Press.

C2-042 (ISBN 0-7566-0946-1) Berger, K. (2005). *Backpacking & Hiking*. New York, NY: DK Publishing, Inc.

C2-051 (ISBN 978-0-7153-2254-3) Bagshaw, C. (Ed.). (2006). *The Ultimate Hiking Skills Manual*. Cincinnati, OH: David & Charles.

TREKKING GEAR CARDS

Fanny Packs



Figure A-1 Fanny Pack

ABC-of-Hiking, 2007, Shop Backpacks, Copyright 2007 by Max Lifestyle.net "Go Hiking like Max". Retrieved 19 April 2007, from <http://www.abc-of-hiking/shopitems/backpacks/prowler5-backpacks.asp>

Characteristics

- Small and unobtrusive;
- Thin belt with pouch sewn on;
- Lightweight; and
- Maximum capacity should be 10 pounds.

Daypacks



Figure A-2 Daypacks

ABC-of-Hiking, 2007, Shop Backpacks, Copyright 2007 by Max Lifestyle.net "Go Hiking like Max". Retrieved 17 April 2007, from <http://www.abc-of-hiking/shopitems/backpacks/team-backpacks.asp>

Characteristics

- Available in various models and sizes;
- May have extra features (loops, pockets, hydration system);
- Firm padding should be found on shoulder straps, waist belt and back padding; and
- Capacity from 15 to 35 L.

Boots



Figure A-3 Hiking Boot

Internet Outdoors Unlimited, 2003, Alpina Trekking Boots, Copyright 2003 by Internet Outdoors Unlimited. Retrieved 17 April 2007, from <http://www.shopoutdoors.com/Alpinahikingboots.html>

Characteristics

- Sturdy;
- Lightweight;
- Offers protection and support;
- Comfortable; and
- Correct size.

Water Carriers



Figure A-4 Hydration System

ABC-of-Hiking, 2007, Shop Water Bottles, Copyright 2007 by Max Lifestyle.net "Go Mountain Biking like Max". Retrieved 17 April 2007, from <http://www.abc-of-mountainbiking/shopitems/water-bottles/unbottle7002-water-bottles.asp>

Characteristics

- Available in various models and capacities;
- Lightweight and durable;
- Many forms, colours and materials; and
- Helps one to stay hydrated.

Socks



Figure A-5 Sock

ABC-of-Hiking, 2007, Shop Hiking Socks, Copyright 2007 by Maxi Lifestyle.net "Go hiking like Max". Retrieved 17 April 2007, from <http://abc-of-hiking.com/shopitems/socks/trailsock-socks.asp>

Characteristics

- Made from various materials;
- Absorbs moisture;
- Provides insulation; and
- Works better in pairs.

Rain Gear



Figure A-6 Rain Jacket

ABC-of-Biking, 2007, Shop Outdoor Jackets, Copyright 2007, by Maxi Lifestyle.net "Go biking like Max". Retrieved 17 April 2007, from <http://www.abc-of-mountainbiking.com/shopitems/jackets/stanza-jackets.asp>

Characteristics

- Available in various models, colours, sizes and shapes;
- Breathable fabric;
- Lightweight;
- Folds away;
- Should have a hood; and
- Waterproof.

Hats



Figure A-7 Hat

ABC-of-Fishing, 2007, Shop Fishing Hats, Copyright 2007 by Maxi Lifestyle.net "Go Fishing like Max". Retrieved 17 April 2007, from <http://www.abc-of-fishing.net/shopitems/hats/voodoo-hats.asp>

Characteristics

- Absorbs sweat;
- Available in various models, colours, sizes and shapes;
- Protects head and neck from the sun and rain; and
- Should have a wide brim.

Extra Insulation



Figure A-8 Fleece

ABC-of-Hiking, 2007, Shop Men's Sweatshirts, Copyright 2007 by Maxi Lifestyle.net "Go Hiking like Max". Retrieved 17 April 2007 from <http://www.abc-of-hiking.com/shopitems/sweatshirts/covertcardigan-mens-sweatshirts.asp>

Characteristics

- Available in various models, colours, sizes and shapes;
- Lightweight;
- Fast drying; and
- To be worn under a jacket.

Sunscreen and Insect Repellent



Figure A-9 Sunscreen and Insect Repellent

Forest Home Outfitters, 2007, Oops I forgot. Retrieved 17 April 2007, from <http://foresthometoutfitters.org/index.php?cPath=37>

Characteristics

- Protects against exposure from the sun; and
- Wards off insects.

Camera and Film



Figure A-10 Digital Camera

WP ClipArt, 2007, Camera Section. Retrieved 18 April 2007 from <http://www.wpclipart.com/camera/index.html>

Characteristics

- Various sizes, models and colours;
- Records memorable moments; and
- Uses batteries.

Bathing Suit and Towel



Figure A-11 One-piece Bathing Suit

Simply Swim, 2007, Arrow One Piece, Copyright 2007 by Hostshopping.co.uk. Retrieved 17 April 2007, from <http://cylinder-bag.hotshopping.co.uk/swimsuits.html>



Figure A-12 Bathing Suit

Morth Marine Austria, 2007, Cliff Swim Trunk, Copyright 2007 by Vorbehaltich Tippfehler Zulezt. Retrieved 17 April 2007, from <http://www.marine-moerth.com/Hellyhansen1.hmt>

Characteristics

- Comfortable;
- As to fit the person; and
- Allows a person to go for a swim or wash.

Binoculars



Figure A-13 Binoculars

ABC-of-Hiking, Shop Binoculars, Copyright 2007 by Maxi Lifestyle.net "Go Hiking like Max". Retrieved 17 April 2007, from <http://www.abc-of-hiking.com/shopitems/binoculars/echocompact-binoculars.asp>

Characteristics

- Various sizes and models; and
- Views objects, routes and wildlife from a far distance.

WEATHER FORECAST SCENARIOS

Scenario A: Sunny Day

The last weekend in June, your cadet corps is going on a trek. The weather forecast for your region says it will be sunny throughout the weekend. What should you bring?

Clothing	Personal Items
<ul style="list-style-type: none"> • balaclava; • extra pair of pants, shirt and socks; • face mask; • gloves; • insulated pants; • jacket; • mittens; • neck gaiter; • pants; • parka; • parka hood; • fleece jacket; • raingear (jacket and pants); • scarf; • shirt; • shorts; • sweater; • tilley cap; • toque/cap; • turtleneck; • undershirt; • vest; and • windbreaker. 	<ul style="list-style-type: none"> • cookware and utensils; • extra food (energy bars, dried fruit or nuts, hard candies, etc.); • extra clothing (warm clothing and raingear); • first aid kit; • flashlight; • insect repellent; • lip balm; • money; • pen and paper (notebook); • personal hygiene kit; • personal medication; • pocket knife or multi-tool; • sunscreen and sunglasses; • a signalling device; • water container; • water filter; and • waterproof matches.

Scenario B: Rainy Day

During your fall navigation/trekking FTX, the Red Star cadets are going on a trek. For the weekend, the weather forecast says it might be windy and rainy. What should you bring?	
Clothing	Personal Items
<ul style="list-style-type: none"> • balaclava; • extra pair of pants, shirt and socks; • face mask; • gloves; • insulated pants; • jacket; • mittens; • neck gaiter; • pants; • parka; • parka hood; • fleece jacket; • raingear (jacket and pants); • scarf; • shirt; • shorts; • sweater; • tilley cap; • toque/cap; • turtleneck; • undershirt; • vest; and • windbreaker. 	<ul style="list-style-type: none"> • cookware and utensils; • extra food (energy bars, dried fruit or nuts, hard candies, etc.); • extra clothing (warm clothing and raingear); • first aid kit; • flashlight; • insect repellent; • lip balm; • money; • pen and paper (notebook); • personal hygiene kit; • personal medication; • pocket knife or multi-tool; • sunscreen and sunglasses; • a signalling device; • water container; • water filter; and • waterproof matches.

Scenario C: Cold and Snowy Day

During your winter adventure training activities FTX, the Red Star cadets are going on a trek. For the weekend, the weather forecast says it will snow and the temperature will be -25 degrees. What should you bring?

Clothing	Personal Items
<ul style="list-style-type: none"> • balaclava; • extra pair of pants, shirt and socks; • face mask; • gloves; • insulated pants; • jacket; • mittens; • neck gaiter; • pants; • parka; • parka hood; • fleece jacket; • raingear (jacket and pants); • scarf; • shirt; • shorts; • sweater; • tilley cap; • toque/cap; • turtleneck; • undershirt; • vest; and • windbreaker. 	<ul style="list-style-type: none"> • cookware and utensils; • extra food (energy bars, dried fruit or nuts, hard candies, etc.); • extra clothing (warm clothing and raingear); • first aid kit; • flashlight; • insect repellent; • lip balm; • money; • pen and paper (notebook); • personal hygiene kit; • personal medication; • pocket knife or multi-tool; • sunscreen and sunglasses; • a signalling device; • water container; • water filter; and • waterproof matches.

WEATHER FORECAST SCENARIOS – ANSWER KEY

Sunny Day Scenario	Rainy Day Scenario
<ul style="list-style-type: none"> • extra pair of pants, shirt and socks; • jacket; • pants; • fleece jacket; • raingear (jacket and pants); • shirt; • shorts; • sweater; • sweater; and • windbreaker. 	<ul style="list-style-type: none"> • extra pair of pants, shirt and socks; • <u>gloves</u>; • jacket; • pants; • fleece jacket; • raingear (jacket and pants); • <u>scarf</u>; • shirt; • sweater; • tilley cap; • <u>toque/cap</u>; • <u>turtleneck</u>; • undershirt; • <u>vest</u>; and • windbreaker.
<ul style="list-style-type: none"> • cookware and utensils; • extra food (energy bars, dried fruit or nuts, hard candies, etc.); • extra clothing (warm and including the raingear); • first aid kit; • flashlight; • insect repellent; • lip balm; • money; • pen and paper (notebook); • personal hygiene kit; • personal medication; • pocket knife or multi-tool; • sunscreen and sunglasses; • a signalling device; • water container; • water filter; and • waterproof matches. 	<ul style="list-style-type: none"> • cookware and utensils; • extra food (energy bars, dried fruit or nuts, hard candies, etc.); • extra clothing (warm and including the raingear); • first aid kit; • flashlight; • insect repellent; • lip balm; • money; • pen and paper (notebook); • personal hygiene kit; • personal medication; • pocket knife or multi-tool; • sunscreen and sunglasses; • a signalling device; • water container; • water filter; and • waterproof matches.
<p>* The items underlined are not mandatory but are acceptable.</p>	

Cold and Snowy Day Scenario

- | | |
|--|--|
| <ul style="list-style-type: none">• balaclava;• extra pair of pants, shirt and socks;• <u>face mask</u>;• gloves or mittens;• insulated pants;• jacket;• neck gaiter or scarf;• pants;• parka;• parka hood;• fleece jacket;• shirt;• sweater;• toque/cap;• turtleneck;• undershirt;• vest; and• <u>windbreaker</u>. | <ul style="list-style-type: none">• cookware and utensils;• extra food (energy bars, dried fruit or nuts, hard candies, etc.);• extra clothing (warm and including the raingear);• first aid kit;• flashlight;• insect repellent;• lip balm;• money;• pen and paper (notebook);• personal hygiene kit;• personal medication;• pocket knife or multi-tool;• sunscreen and sunglasses;• a signalling device;• water container;• water filter; and• waterproof matches. |
|--|--|

* The items underlined are not mandatory but are acceptable.

STRETCHES AND EXERCISES

EXERCISES TO BUILD BODY STRENGTH

Legs

Abductor Raise. Lie on the floor on the left side with the left leg slightly bent. Place the right hand in front for support. Keeping the right leg straight and in line with the body, raise it with a slow, controlled movement. Hold for one second, lower and then repeat. Repeat the exercises a minimum of 10 times on both sides.



Figure D-1 Abductor Raise

*Yahoo Health, 2007, Basic Muscle-conditioning Exercises, Copyright 2002 by Nucleus Communications Inc.
Retrieved 29 March 2007, from <http://health.yahoo.com/topic/weightloss/overview/article/healthwise/popup/zm2427>*

Lunge. Keep hands on sides with shoulder-width apart. Step forward with one leg, bending both knees until the thigh is parallel with the knee. Push back to starting position. Alternate legs. Do not let back knee touch the ground. Repeat this exercise a minimum of 10 times on both sides.



Figure D-2 Lunges With Weights

Department of Public Health County of Los Angeles California, 2006, LAPublicHealth.org/Strength Training, Copyright 2006 by LADPH. Retrieved 27 March 2007, from <http://www.lapublichealth.org/physact/physactstrength.htm>

Glutes Raise. Hands in front shoulder-width apart. The back should stay straight. Keeping the right leg bent, raise it into the air. Press up into the heel. Count two seconds up and two seconds down. Repeat a minimum of 10 times on both sides.



Figure D-3 Glutes Raise

Bodybuilding.com, 2007, Exercise Guides-Glute Kickback, Copyright 2007 by Bodybuilding.com. Retrieved 29 March 2007, from <http://bodybuilding.com/fun/exercises.php?mainmuscle=glute>

Arms

Pushups. Place hands directly under the shoulders, keeping fingers pointed forward and legs in line with the body. Lower the body toward the floor without touching it and then push off the floor to the start position. Do as many as you can.

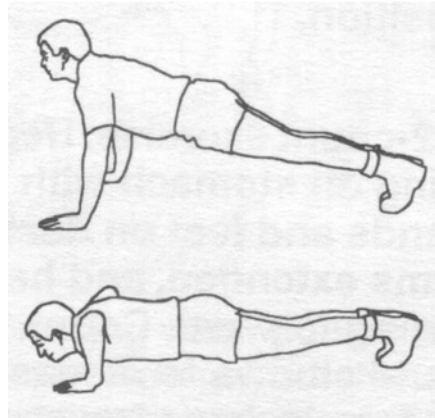


Figure D-4 Push Up

The Fitness Motivator.com, 2006, Add these Basic Exercises to your fitness plan. Retrieved on 29 March 2007, from <http://www.the-fitness-motivator.com/basicexercises.html>

Back and Shoulders

Lateral Raise With Weights. Hold weights at the sides, palms facing in. Slowly raise arms to shoulder level and lower. Keep arms and wrists straight. This exercise should be repeated a minimum of 10 times on both sides.

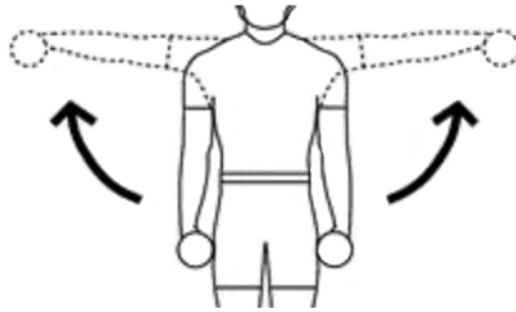


Figure D-5 Lateral Raises With Weights

Weight Lifting Workout Routines, 2006, Shoulder Exercises, Copyright, 2006 by Weight Lifting Workout Routines. Retrieved 29 March 2007, from <http://www.weight-lifting-workout-routines.com/shoulder-exercises.html>

Stomach

Crunches. Lie on the back bringing the legs up over the hips and cross the ankles. Place the arms either on the thighs, across the chest or beside the head (hardest). Slowly curl up using abs to lift shoulders from ground at the same time. Do not swing legs. Repeat a minimum of 10 times on both sides. The number of repetitions can increase with comfort level.

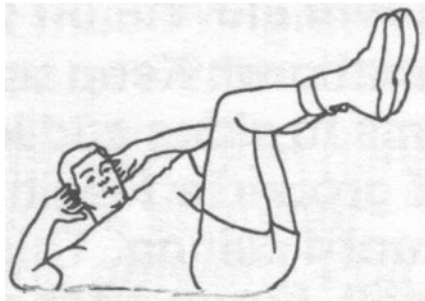


Figure D-6 Crunches Position

The Fitness Motivator.com, 2006, Add these Basic Exercises to Your Fitness Plan. Retrieved on 3 April 2007, from <http://www.the-fitness-motivator.com/basicexercises.html>

STRETCHING EXERCISES BEFORE AND DURING THE TREK

Neck. Slowly roll the head across the chest from shoulder to shoulder. Do not roll head backwards.

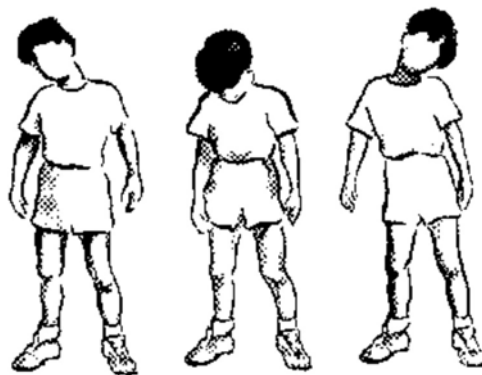


Figure D-7 Neck Stretch

Moving on the Spot: A Collection of 5-Minute Stretch and Movement Sessions, by B. Hanson, 1999, Toronto, ON: Toronto Public Health. Retrieved 26 October 2006, from <http://www.lin.ca/resource/html/dn3.htm#1>

Shoulders. Stand and raise the top of the shoulders toward the ears until a slight tension is felt in neck and shoulders. Hold for five seconds. Then relax shoulders downward. This exercise can be repeated several times.

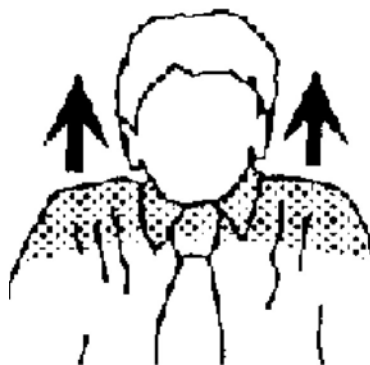


Figure D-8 Shoulders Stretch

University of Michigan Occupational Safety & Environmental Health, 2007, Basic Office Stretches, Copyright 2007 by The Regents of the University of Michigan. Retrieved 28 March 2007, from http://www.oseh.unmich.edu/ergonomics_intro.html

Triceps and Top of Shoulders. Stand up and bring the right arm over the head, bent at the elbow. Use the left hand to gently pull the arm down. Hold this position for a minimum of 10 seconds. This exercise should be repeated a minimum of 10 times on both sides.



Figure D-9 Triceps Stretch

Smart Start: A Flexible Way to Get Fit. Retrieved 26 October 2006, from <http://www.in-motion.ca/walkingworkout/plan/flexibility/>

Shoulders, Arms and Chest. Interlace fingers behind the back. If this feels fairly easy, then lift the arms up behind the back until a stretch is felt in the arms, shoulders, or chest. Hold for 10 to 15 seconds. Keep chest and chin out.



Figure D-10 Shoulders, Arms and Chest Stretch

University of Michigan Occupational Safety & Environmental Health, 2007, Basic Office Stretches, Copyright 2007 by The Regents of the University of Michigan. Retrieved 28 March 2007, from http://www.oseh.unmich.edu/ergonomics_intro.html

Hamstrings, Back Knees and Legs. Stand with feet shoulder-width apart and pointed straight ahead. Slowly bend forward from the hips. Keep your knees slightly bent. Go to the point where a slight stretch is felt in the back of the legs. Hold for 10 to 15 seconds.



Figure D-11 Hamstring, Back Knees and Leg Stretch

PC Coach, 2005, Stretching for Runners, Copyright 2005 by Biometrics Inc. Retrieved on 29 March 2007, from <http://www.pccoach.com/newsletters/may05/stretching.htm>

Front Hip and Lower Back Area. Start with one leg in front of the other, with the ankle of the front leg directly below the front knee. The other knee is resting on the ground. Place hands on top of each other on the thigh, just above the knee. Hold for 10 to 15 seconds and repeat for the other side.

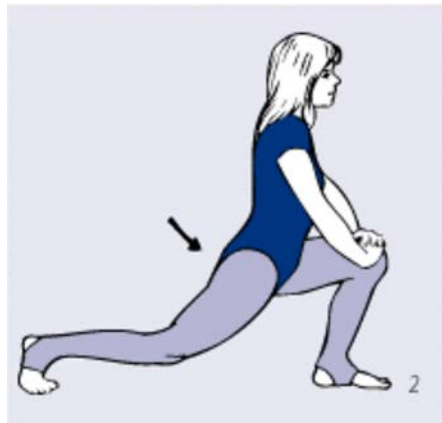


Figure D-12 Stretch for Hip and Lower Back Area

ARC Committed to Curing Arthritis, 2007, Back Pain, Copyright 2007 for Arthritis Research Campaign. Retrieved 27 March 2007, from http://www.arc.org.uk/about_arth/booklets/6002/6002

Quads and Knees. Hold the top of the right foot with the left hand and gently pull the heel toward the buttocks. Hold for 10 to 15 seconds and repeat for the other leg.



Figure D-13 Quads and Knees Stretch

*Women's Heart Foundation, 2005, Stretching Exercises for Women, Copyright 2005 for Women's Heart Foundation.
Retrieved 28 March 2007, from http://www.womensheart.org/content/exercises/stretching_exercises.asp*

Squat. Squat down with feet flat and toes pointed out at 15 degrees. Heels should be apart depending on how flexible one is. Keep the knees to the outside of the shoulders, directly above the big toes. Hold for 15 to 30 seconds. Using a fence or pole for balance is acceptable.



Figure D-14 Squat Position

*The Back Rack, 1999, Cycling Stretches After Riding, Copyright 1999 by Stretching
Inc. Retrieved 29 March 2007, from <http://thebikerack.com/page.cfm?pageId=247>*

Ankles. Lift the left foot off the ground and rotate the foot and ankle 10 to 15 times clockwise and then counterclockwise. Repeat for the right foot and ankle.



Figure D-15 Ankle Rotation

*Women's Heart Foundation, 2005, Stretching Exercises for Women, Copyright 2005 by Women's Heart Foundation.
Retrieved 28 March 2007, from http://www.womensheart.org/content/exercises/stretching_exercises.asp*



ROYAL CANADIAN ARMY CADETS

RED STAR

INSTRUCTIONAL GUIDE



SECTION 2

EO M223.02 – IDENTIFY HIKING/TREKKING ASSOCIATIONS

Total Time: 30 min

PREPARATION

PRE-LESSON INSTRUCTIONS

Resources needed for the delivery of this lesson are listed in the lesson specification located in A-CR-CCP-702/PG-001, Chapter 4. Specific uses for said resources are identified throughout the Instructional Guide within the TP for which they are required.

Review the lesson content and become familiar with the material prior to delivering the lesson.

To facilitate the delivery of TP1, seek out hiking/trekking associations in your community and use them in the provincial associations portion of the TP.

PRE-LESSON ASSIGNMENT

N/A.

APPROACH

An interactive lecture was chosen for this lesson to give an overview of civilian hiking/trekking organizations, their mandate and the government resources available.

INTRODUCTION

REVIEW

N/A.

OBJECTIVES

By the end of this lesson the cadet shall have participated in a discussion on hiking/trekking associations.

IMPORTANCE

It is important for cadets to know the civilian resources available in the world of hiking and trekking, as it may help them develop an interest in those activities.

Teaching Point 1**Identify Civilian Hiking/Trekking Organizations and Their Mandate**

Time: 20 min

Method: Interactive Lecture

NATIONAL ASSOCIATIONS**The Alpine Club of Canada**

The Alpine Club of Canada is a national mountaineering organization. It was created in 1906 with the support of Pacific Railway. It is now based in Canmore, Alberta. The Alpine Club of Canada has 19 regional clubs: Vancouver Island, Vancouver, Whistler, Okanagan, Prince George, Rocky Mountain, Jasper, Calgary, Central Alberta, Edmonton, Saskatchewan, Manitoba, St. Boniface, Thunder Bay, Toronto, Outaouais, Ottawa, Montreal, and Montréal (français).

The Alpine Club of Canada offers the following to its members:

- mountain adventures opportunities (rock climbing, mountaineering courses, trips or activities);
- rental opportunities for huts and cabins;
- climbing competitions;
- social events; and
- publications related to the mountain culture.

The Alpine Club of Canada is also involved in the community. It offers grants to mountaineering projects and has a protection and environmental conservation program.



To contact the Alpine Club of Canada: <http://www.alpineclubofcanada.ca/>.

Trails Canada

Launched in June 2000, Go Green was created to support and promote Canadian trails and the Canadian trails system. It also provided Internet resources on the trail system. Go Green was a partnership between Trails Canada, COMPAQ Canada and Government of Canada Millennium Partnership Grant. Four years later, the name of the Website was changed to Trails Canada. Trails Canada's mission is to create a trail network dedicated to helping people find trails in any province or territory.

Trails Canada provides the following:

- on-line tools and support services for trail users and community trail groups;
- inventories of Canadian trails by region;
- descriptive information on trail terrain, scenery, nature notes, accessibility, etc.;
- trail construction and advocacy tools for communities;
- on-line trail registry allowing community trail groups to promote their trails worldwide;

- news and information through an on-line newsletter (The Pathfinder); and
- a calendar of events allowing community groups to promote trail activities to a worldwide audience.

The trail inventory now contains more than 3900 trails, with entries in every province and territory in Canada.



To contact Trails Canada: <http://www.trailscanada.com/index.htm>.

The Trans Canada Trail

The Trans Canada Trail is a community-based project. It is owned, operated and maintained by local organizations, municipalities, provincial authorities and national agencies across Canada. The Trans Canada Trail is a recreational trail that crosses the country.

This 18 000 km recreational corridor winds its way through every province and territory, linking over 800 communities along its route. When completed, this will be the longest trail of its kind in the world, connecting regions and the three oceans.

The Trans Canada Trail provides the following:

- maps of the majority of the trail's section;
- guidebooks; and
- a Website trail locator.



To contact the Trans Canada Trail: <http://www.tctrail.ca/home.php>.

PROVINCIAL ASSOCIATIONS



Focus on the associations from your province only. If time allows, associations from neighbouring provinces may be presented.

Kootenay Mountaineering Club (BC)

The Kootenay Mountaineering Club (KMC) started in April 1964 as a section of the Alpine Club of Canada. In 1968, the section was dissolved and in 1969, the same group was resurrected as the Kootenay Mountaineering Club. The KMC is a non-profit society based in the Kootenay region of southeastern British Columbia. The KMC promotes an interest in, and the development of, mountaineering skills, fellowship, and conservation of the natural values in the mountains.

The KMC organizes outdoor activities year round including: hiking, climbing, skiing, and mountain biking trips; hiking and climbing camps; and training classes to teach basic mountaineering skills. KMC also organizes a number of social gatherings during the year. It is involved in building and maintaining huts and trails throughout the Kootenay region.

The KMC publishes a monthly newsletter, which includes a list of upcoming activities, descriptions of recent trips, comments on issues in which the Club is involved, and other articles of general interest. The KMC also publishes an annual journal and maintains a library of mountaineering books and magazines.

The KMC also takes an active role in conserving and defending the natural values of the mountains.



To contact the Kootenay Mountaineering Club: <http://www.kootenaymountaineering.bc.ca/>.

West Coast Trail (BC)

The West Coast Trail is located on the southern west coast of Vancouver Island and stretches 75 km from Port Renfrew on the south end to Bamfield on the north end.

The West Coast Trail is one of three components of the Pacific Rim National Park Reserve of Canada.

The trail started with a shipwreck back on January 22, 1906. The 77 m vessel SS Valencia ran aground just north of Klanawa River on Vancouver Island's west coast. The wild and rugged shoreline, bordering a temperate rain forest, offered no relief whatsoever and the lives of all 126 passengers were lost. This tragic event spurred the government at that time to construct a trail between Port Renfrew and Bamfield in case of future shipwrecks (as this section of the Pacific had been the site of more than 60 shipwrecks since 1854). The present West Coast trail generally follows the route of the historic life- saving trail.

Through the Pacific Rim National Park Reserve of Canada, Parks Canada manages the reservations for any activities on the trail.

Edmonton Outdoor Club (AB)

Founded March 1, 2006, the Edmonton Outdoor Club (EOC) is a volunteer-run organization for adults, featuring adventure sports (mostly non-competitive), social events and travel excursions in and around the Edmonton area. The EOC's mission is to provide its members with fun experiences, the opportunity to network, and the ability to learn about and participate in local adventure sports.

The EOC hosts a wide variety of events every year, including:

- adventure sports – hiking, camping, backpacking, mountain biking, paddling, skiing, skating, snow shoeing, etc.;
- social events – socials, spectator sporting events, etc.; and
- travel – adventure trips and expeditions to various parts of Canada and the U.S., and possibly beyond.

Membership is open to any interested adult, regardless of their experience level. Members pay only for those events they attend and membership is free, although member support, in the form of both time and monetary donations, is solicited to keep the club running. There is no paid staff.



To contact the Edmonton Outdoor Club: <http://www.edmontonoutdoorclub.com/>.

Manitoba Recreational Trails Association Inc. (MB)

The Manitoba Recreational Trails Association (MRTA) is the official body overseeing the coordination of the building of the Trans Canada Trail in Manitoba. It is composed of volunteers and is located in Winnipeg. The MRTA helps with:

- providing funding to recognized trail associations for trail development;
- providing trail-building resources to trail associations;
- promoting the Trans Canada Trail in Manitoba; and
- promoting other trails and trail use in Manitoba.



To contact the Manitoba Recreational Trails Association Inc: <http://www.mrta.mb.ca/>.

Hike Ontario (ON)

Hike Ontario was founded in 1974 and is a non-profit organization dedicated to serving the needs of all hikers and walkers in the province of Ontario. Hike Ontario does not make or maintain trails, nor does it offer organized hiking/walking events, except through its member associations.

Hike Ontario's mission is to encourage walking, hiking and trail development in Ontario. It also provides a list of clubs one can join and a list of various hiking, trekking and mountaineering courses one can take.



To contact Hike Ontario: <http://www.hikeontario.com/>.

Ontario Trails Council (ON)

The Ontario Trails Council (OTC) was established in 1988. It started as a coalition of trail user groups, such as hikers, cyclists, snowmobilers, equestrians, etc. with a shared interest in trails and the conservation of abandoned rail lines for use as trails. It is a volunteer led, charitable organization, promoting the creation, preservation, management and use of recreational trails in Ontario.

Memberships have broadened to include other similar trail organizations and others with similar interests and values.

The following are the OTC's goals:

- Encourage the establishment of the Trillium Trail Network.
- Increase the number, length, variety and accessibility of trails throughout the province.
- Provide government and other public bodies with an informed, credible voice in support of trail interest groups.
- Promote the safe and responsible use of trails.
- Act as a provincial resource centre for trail information.



To contact The Ontario Trails Council: <http://www.ontariotrails.on.ca/>.

Toronto Outdoor Club (ON)

Founded May 1, 2005, the Toronto Outdoor Club (TOC) is a volunteer-run organization for adults, featuring adventure sports (mostly non-competitive), social events and travel excursions in and around the Toronto area. The TOC's mission is to provide its members with fun experiences, the opportunity to network, and the ability to learn about and participate in local adventure sports.

The TOC hosts a wide variety of events every year, including:

- adventure sports – hiking, camping, backpacking, mountain biking, paddling, skiing, skating, snow shoeing, etc.;
- social events – socials, spectator sporting events etc.; and
- travel – adventure trips and expeditions to various parts of Canada and the U.S., and possibly beyond.

Membership is open to any interested adult, regardless of their experience level. Members pay only for those events they attend and membership is free, although member support, in the form of both time and monetary donations, is solicited to keep the club running. There is no paid staff.



To contact the Toronto Outdoor Club: <http://www.torontooutdoorclub.com/>.

The Bruce Trail Association

The Bruce Trail is the oldest and longest continuous footpath in Canada. It runs along the Niagara Escarpment from Niagara to Tobermory, spanning more than 850 km of main trail and 250 km of side trails. It started in 1960 with the idea of a public footpath spanning the entire Niagara Escarpment. Regional clubs were established in 1963 and they were responsible for organization, landowner approvals, construction and maintenance.

The Bruce Trail Association is a charitable organization committed to establishing a conservation corridor containing a public footpath along the Niagara Escarpment, in order to protect its natural ecosystems and to promote environmentally responsible public access to this UNESCO World Biosphere Reserve.



To contact the Bruce Trail Association: <http://www.brucetrail.org/>.

Fédération québécoise de la marche (QC)

The Fédération québécoise de la marche was created to promote any type of walk. Four times a year, the Federation publishes a magazine called "Marche Randonnée". It contains calendars, information on upcoming activities, suggestions on hiking and trails to use, information on health, lifestyle, environmental issues and information and advice on new equipment, etc. Everything is related to hiking and trekking.

The federation is involved in the Trans Canada Trail project and promotes good trail etiquette.

The federation also publishes a book on trails and locations one can use in the province of Quebec.



To contact the Fédération québécoise de la marche: <http://www.fqmarche.qc.ca/>

Le club de montagne Le Canadien (QC)

Le club de montagne Le Canadien was created in 1949 and is one of the oldest francophone clubs in North America. It is a volunteer-based organization that focuses on outdoor activities. The club organizes yearly activities like:

- hiking and trekking;
- camping; and
- cross-country skiing and snowshoeing.

For all of its activities, the club offers carpooling opportunities to reduce the impact on the environment. It also organizes volunteer groups to maintain and clean trails in regions of Quebec.

The club publishes a monthly bulletin on its activities.



To contact Le club de montagne Le Canadien: <http://www.clubmontagnecanadien.qc.ca/>.

The International Appalachian Trail (QC)

The International Appalachian Trail started in 1996. The layout was coordinated by the corporation International Appalachian Trail-Quebec (IAT-QC). Many volunteers and organizations in each region crossed by the trail were involved in the project.

The trail is 644 km long and extends from Cap-Gaspé, located in Forillon National Park (QC), to Matapédia (QC).

The International Appalachian Trail symbolizes the will of the people of Quebec, New Brunswick and Maine to collaborate in the protection and promotion of the environment that joins them. The association was given the objective to arrange a path approximately 1034 km in length, including approximately 600 km in Quebec, 274 km in New Brunswick and 160 km in Maine. The Appalachian Trail, which was built over 60 years ago and which attracts approximately 37 million hikers annually to its 3455 km trail, connects the Quebec path to Mount Katahdin, in Maine.

Consequently, the International Appalachian Trail is 4489 km in length, which makes it the longest path in North America. For comparison, the Great Wall of China is only 3000 km.

The association can provide:

- a trip planner;
- maps;
- information on campgrounds and shelters; and
- information on flora and fauna.



To contact The International Appalachian Trail (QC): <http://www.sia-iat.com>.

To use the International Appalachian Trail, a permit is needed.



The International Appalachian Trail has a chapter in Newfoundland and Labrador. To contact the Newfoundland and Labrador chapter: www.internationalat.org/pages/index.

New Brunswick Trail Council Inc. (NB)

The New Brunswick Trails Council Inc. (NBTCI) is a non-profit, membership/volunteer organization dedicated to the advancement of the trails movement in New Brunswick. Its mandate is to work for the improvement of trails throughout New Brunswick and to help local trail sponsors build, maintain, and promote their local trails.

The NBCTI provides a safe trail network with rules for use of trails and enforcement. It also offers the following:

- trail related expertise, consulting, and information;
- trail guides;
- newsletters;
- updated Website;
- Adopt a Trail program; and
- trail patrol service.



To contact the New Brunswick Trail Council Inc: <http://www.sentiernbtrail.com/>.

The Nova Scotia Trails Federation (NS)

The Nova Scotia Trails Federation (NSTF) was created in 1988 and is a non-profit organization. The primary goal of the NSTF is to promote the development and responsible use of recreational trails for the benefit and enjoyment of all visitors. It also represents the interest of trail users and community-based recreational trail groups across Nova Scotia. NSTF supports local groups in their efforts to plan, build, maintain and manage their segments of trail.

The NSTF has adopted the motto “Take Trails to H.E.A.R.T”. The letters in H.E.A.R.T stand for health, environment, arts (culture and heritage), recreation and transportation.

On the NSTF web site, one can find the following:

- a trail finder;
- trail etiquette and safety; and
- a newsletter “Trail Talk”.

The NSTF also provides a trail patrol service.



To contact the Nova Scotia Trails Federation: <http://novascotiatrials.com/>.

Island Trails (PE)

Island Trails is a non-profit organization dedicated to the development, maintenance, and promotion of Prince Edward Island's network of trails.

The organization provides help in planning expeditions and a virtual trail finder. Trails are accessible for the following activities:

- hiking;
- trekking;
- cycling; and
- snowmobiling.



To contact Island Trails: <http://www.islandtrails.ca/>.

East Coast Trail (NL)

The East Coast Trail association is a member driven, volunteer based, non-registered charity formed in 1994 in Newfoundland and Labrador. Its mission is to develop, maintain and operate the East Coast Trail and deliver a high quality wilderness hiking experience, while respecting the integrity of the environment and the needs of communities.

There is no fee to use the trail and no fees to participate in the public hiking program.

The association provides access to abandoned settlements, lighthouses, ecological reserves, seabird colonies, whales, icebergs, the world's southern-most caribou herd, historic sites, a 50-metre suspension bridge and two active archaeological dig sites.



To contact East Coast Trail: <http://www.eastcoasttrail.com/>.

CONFIRMATION OF TEACHING POINT 1

QUESTIONS

- Q1. Name three national hiking/trekking associations.
- Q2. What is the mission of Trails Canada?
- Q3. Name any three provincial associations.

ANTICIPATED ANSWERS

- A1. The Alpine Club of Canada, Trails Canada and the Trans Canada Trail are three national hiking/trekking associations.
- A2. Trails Canada's mission is to create a trail network dedicated to helping people find trails in any province or territory.
- A3. Kootenay Mountaineering Club (BC), West Coast Trail (BC), Edmonton Outdoor Club (AB), Manitoba Recreational Trails Association Inc. (MB), Hike Ontario (ON), Ontario Trails Council (ON), Toronto Outdoor Club (ON), The Bruce Trail Association (ON), Fédération québécoise de la marche (QC), Le club de montagne Le Canadien (QC), The International Appalachian Trail (QC), New Brunswick Trail Council (NB), The Nova Scotia Trails Federation (NS), Island Trails (PE) and East Coast Trail (NL) are all the provincial associations.

Teaching Point 2

Identify Government Hiking/Trekking Resources

Time: 5 min

Method: Interactive Lecture



Park wardens patrol all national and provincial parks. Parks have offices with which users may have to register or get a permit before entering. It is always a good idea to check in with park offices before starting an expedition. Parks wardens should be aware of travel intentions and the return date. Users should also check out with park offices on leaving the park after their expedition.

PARKS CANADA

Parks Canada is a federal government department that has been working to protect and present Canada's natural and cultural heritage for over a century. Park Canada's mandate is also to foster public understanding, appreciation and enjoyment in ways that ensure ecological integrity of their parks.

Parks Canada works with other government departments and non-governmental agencies to provide trip planning and safety information for visitors. It is also responsible for search and rescue within any national parks.

Parks Canada oversees four main departments:

- National Parks;
- National Marine Conservation areas of Canada;
- Cultural Heritage; and
- Natural Heritage.

Parks Canada has established policies for park users. Since national parks are protected areas, the policies concern the respect of other users, the environment and wildlife.

Parks Canada also provides the following services:

- a list of all National parks and their location;
- a list of campgrounds available, their cost and a reservation service;
- a list and maps of their trails;

- youth and group programs; and
- a help desk service to help users plan their trips.

Any national park will have a visitor information service.



To contact Parks Canada: <http://www.pc.gc.ca/>.

PROVINCIAL PARKS

Provincial Parks are overseen by their provincial government. The majority of provincial parks work in collaboration with Parks Canada to keep a similar code of ethics, policies for park users and activities.

Provincial parks usually offer the following:

- accommodations, campgrounds and reservation service; and
- guides and maps of trails and activities offered.

Activities within provincial parks may change from province to province. Here is a brief list of typical activities one may find in a provincial park:

- cross country skiing;
- cultural/natural exhibits;
- cycling;
- fishing (locations);
- guided hikes;
- hiking and trekking;
- kayaking and canoeing;
- rock climbing areas;
- snowshoeing; and
- swimming.



- British Columbia: <http://www.env.gov.bc.ca/bcparks/>.
- Alberta: http://www.cd.gov.ab.ca/enjoying_alberta/parks/planning/gateway/index.aspx.
- Saskatchewan: <http://www.se.gov.sk.ca/saskparks/>.
- Manitoba: <http://www.gov.mb.ca/conservation/parks/>.
- Ontario: <http://www.ontarioparks.com/english/index.html>.
- Quebec: <http://www.sepaq.com/index-en.html>.
- New Brunswick: <http://www.tourismnewbrunswick.ca/enCA/HNNationalAndProvincialParks/>.
- Nova Scotia: <http://parks.gov.ns.ca/>.
- Newfoundland and Labrador: <http://www.env.gov.nl.ca/parks/>.
- Yukon, North West Territories and Nunavut only have national parks. The information is available on Parks Canada Website.

CONFIRMATION OF TEACHING POINT 2

QUESTIONS

- Q1. Name the four departments that Parks Canada oversees.
- Q2. Name two services that can be provided by Parks Canada.
- Q3. Name four typical activities one may find in a provincial park.

ANTICIPATED ANSWERS

- A1. Parks Canada oversees national parks, the national marine conservation areas of Canada, cultural heritage and natural heritage.
- A2. Parks Canada can provide a list of all national parks and their location, a list of campgrounds available, their cost and a reservation service, a list and maps of their trails, youth or group programs and a help desk service to help users plan their trips.
- A3. Cross country skiing, cultural/natural exhibits, cycling, fishing (locations), guided hikes, hiking and trekking, kayaking and canoeing, rock climbing areas, snowshoeing, and swimming are the typical activities one can find in a provincial park.

END OF LESSON CONFIRMATION

QUESTIONS

- Q1. Name three national hiking/trekking associations.
- Q2. What is the mandate of Parks Canada?
- Q3. What are the two things a provincial park usually provides?

ANTICIPATED ANSWERS

- A1. The Alpine Club of Canada, Trails Canada and the Trans Canada Trail are three national hiking/trekking associations.
- A2. Parks Canada's mandate is to work to protect and present Canada's natural and cultural heritage and to foster public understanding, appreciation and enjoyment in ways that ensure ecological integrity of their parks.
- A3. Provincial parks provide accommodations and campgrounds to rent, a reservation service and guides, maps of trails and activities.

CONCLUSION

HOMEWORK/READING/PRACTICE

N/A.

METHOD OF EVALUATION

N/A.

CLOSING STATEMENT

Knowing about the civilian hiking/trekking associations in your province may be very practical when planning an expedition. Government departments and civilian associations can provide useful information and educate novice trekkers.

INSTRUCTOR NOTES/REMARKS

N/A.

REFERENCES

- C0-078 Mountain Equipment Co-op. (2007). *Connect*. Retrieved 28 February 2007, from <http://www.mec.ca>.
- C2-052 Parks Canada. (2007). *National Parks of Canada*. Retrieved 28 February 2007, from <http://www.pc.gc.ca>.
- C2-055 The Alpine Club of Canada. (2007). *The Alpine Club of Canada: Canada's National Mountaineering Organization*. Retrieved 28 February 2007, from <http://www.alpineclubofcanada.ca/index.html>.
- C2-056 Trails Canada. (2007). *Trails Canada*. Retrieved 28 February 2007, from <http://www.trailscanada.com>.
- C2-057 The Trans Canada Trail. (2007). *Welcome to Trans Canada Trail*. Retrieved 28 February 2007, from <http://www.tctrail.ca>.
- C2-058 Hike Ontario. (2007). *Hike Ontario*. Retrieved 28 February 2007, from <http://www.hikeontario>.

THIS PAGE INTENTIONALLY LEFT BLANK



ROYAL CANADIAN ARMY CADETS

RED STAR

INSTRUCTIONAL GUIDE



SECTION 3

EO M223.03 – PARTICIPATE IN A DISCUSSION ON CROSSING OBSTACLES WHILE TREKKING

Total Time: 60 min

PREPARATION

PRE-LESSON INSTRUCTIONS

Resources needed for the delivery of this lesson are listed in the lesson specification located in Chapter 4 of the QSP. Specific uses for said resources are identified throughout the Instructional Guide within the TP for which they are required.

Review the lesson content and become familiar with the material prior to delivering the lesson.

PRE-LESSON ASSIGNMENT

N/A.

APPROACH

An interactive lecture was chosen for this lesson to introduce safe techniques to cross natural obstacles, to give direction on procedures and to illustrate the application of the concepts.

INTRODUCTION

REVIEW

N/A.

OBJECTIVES

By the end of this lesson the cadet shall be expected to know how to cross obstacles while trekking.

IMPORTANCE

It is important for cadets to know how to cross obstacles while trekking as Red Star training introduces Class 2 hiking terrain and longer treks. It will help the cadets be prepared and meet the physical challenges of an expedition.

Teaching Point 1

Discuss Trekking Poles and Walking Sticks

Time: 15 min

Method: Interactive Lecture

TYPES OF POLES AND STICKS

There are three types of trekking poles – ski poles, wooden walking sticks and telescoping trekking poles. Depending on the activity, the choice of pole will be different.

Trekking poles provide better balance and reduce the amount of stress on the knees, shoulders and back. They absorb some of the impact the body would otherwise absorb. The poles, rather than the body, absorb shock, reduce arm and leg fatigue and improve endurance.

Ski poles and walking sticks may be used for long walks and easy treks on fairly level surfaces. The walking stick may be an acceptable choice for moderate treks. Telescoping trekking poles are the most versatile choice. They work well for hiking and trekking on rough terrain.



Figure 1 Ski Pole

*Black Diamond, 2005, Gear, Copyright 2006 by Black Diamond Equipment Ltd.
Retrieved 12 April 2007, from http://www.bdel.com/gear/fixed_length_ski.php*



Figure 2 Telescoping Trekking Pole

*Wintergoodies.com, 2007, Hiking, Trekking & Walking Pole Adjustable, Copyright 2007 by Wintergoodies.com.
Retrieved 12 April 2007, from http://www.winterbrookgoodies.com/pd_swissgear_hiking_trekking_walking_pole.cfm*



Figure 3 Wooden Walking Stick

The Walking Stick, 2005, Hiking Poles & Walking Sticks & Staffs, Copyright 2005 by The Walking Stick. Retrieved 12 April 2007, from <http://www.backpacking.net/walkstik.html>



Some people like to have one hand free and only use one pole. For a greater level of support, two is better.

A solid wooden walking stick can be picked up in nature at any time during an expedition.

CRITERIA FOR CHOOSING POLES

To find the right trekking poles or walking stick, one should think about the type of activities for which they will be used, the type of terrain and the weight one will carry.



Aluminum telescoping poles are the best option. They are affordable and will last longer.

Telescopic Adjustment. Poles with telescopic adjustment may be adjusted to be longer or shorter depending on the type of terrain. Multiple people can use the same set of poles by adjusting the length. The poles are easy to store when not in use.



Figure 4 Telescoping Pole

Alibaba.com, 2007, Trekking Poles, Copyright 2007 by Alibaba.com Corporation and Licensors. Retrieved 17 April 2007, from http://aoqida.en.alibaba.com/product/50252655/51316862/Trekking_Poles/Trekking_Pole.html

Grips. Grips that have been shaped to fit the hand are more comfortable to grasp and easier to use over a long period of time. Grips that are hard can get wet with sweat and be uncomfortable to hold. One should try multiple models to find the one that fits the hand the best. An adjustable strap should be attached to the grip to prevent dropping the pole.



Figure 5 Grip With Strap

Moontrail, Backcountry Equipment Ltd, 2006, MSR Denali II, Telescoping Trekking poles, Copyright 2006 by Backcountry Equipment, Ltd. Retrieved 17 April 2007, from <http://moontrail.com/msr-denali2.php>

Anti-shock System (shock absorption). The anti-shock system is built into the pole. Some systems are very complex and offer a range of settings depending on the user's preferences and the conditions of the trek. The anti-shock system helps absorb the impact of the pole striking the ground as one walks, easing the strain on the shoulders and arms. A lock system is a must as it allows the user to ensure the settings are locked and will not change during the hike.

Baskets. Baskets are the round rings at the bottom of trekking poles. The basket stops the poles from sinking into the surface (snow, mud or waterlogged ground). There are a variety of baskets. Baskets that are cut out like snowflakes are best used in the snow. Large, solid baskets are best used on soft muddy ground as they prevent sinking. If one is planning to buy trekking poles with baskets, ensure the baskets can easily be changed.



Figure 6 Snowflake Baskets

Backcountry Edge, 2004, LEKI Snowflake Baskets, Copyright 2004 by Backcountry Edge, Inc. Retrieved 17 April 2007, from http://www.backcountryedge.com/products/leki/snowflake_baskets.aspx



Figure 7 Solid Baskets

Backcountrygear.com, 2007, Black Diamond Trekking Pole Spare Baskets. Retrieved 17 April 2007, from <http://www.backcountrygear.com/catalog/accessdetail.cfm/BD320>

Tips. There are three types of tips – single point, chiselled and rubber tipped. Each of these tips will work well in a certain environment. The best overall tip is the chiselled. It looks like notches have been cut out of the very tip of the pole, leaving several points sticking out. This type of tip offers traction in almost any condition and is durable.



Figure 8 Replaceable Tips

GoSki-Real Resort Info, 2005, Poles and Trekking Poles, Copyright 2005 by RSN. Retrieved 17 April 2007, from http://www.goski.com/gear/product/LifeLink_Replaceable_Flex_Tip_Pair.html

USING TREKKING POLES

Using trekking poles may help prevent aches and pains. Poles are useful to help stabilize heavy loads and to negotiate trails. Besides providing better balance, trekking poles reduce the amount of stress on the back, legs and especially the knees. The poles absorb some of the impact the body would have to endure.



As an explanation is given, demonstrate the different techniques for holding trekking poles.

Trekking Uphill. For walking on even terrain, arms should be parallel to the ground when holding the grip. When trekking uphill, shorten the trekking poles for comfort and stability. It allows one to gain more power.



Figure 9 Trekking Uphill

*TrekkingPoles.com, 2006, How to Use Trekking Poles, Copyright 2006 by NicheRetail, LLC Company.
Retrieved 26 April 2007, from http://www.trekkingpoles.com/custserv/custserv.jsp?pageName=How_To_Use*

Trekking Downhill. Trekking poles will help reduce the shock of each footfall on the joints when going downhill.



Figure 10 Trekking Downhill

*TrekkingPoles.com, 2006, How to Use Trekking Poles, Copyright 2006 by NicheRetail, LLC Company.
Retrieved 26 April 2007, from http://www.trekkingpoles.com/custserv/custserv.jsp?pageName=How_To_Use*

The following may help while descending on rocky terrain:

- Walk slowly and test each rock before placing body weight on it.
- On even ground, lean forward to place bodyweight on the trekking poles.
- Grip the trekking pole securely.
- Keep the arms bent at 90 degrees.
- When possible, move one pole forward and step through with the opposite leg.

When trekking downhill, lengthen the trekking poles for comfort and stability.



Trekking poles can also be used to:

- probe the depth of puddles or the strength of snow bridges;
- ward off aggressive animals; and
- provide support for a camera.

CONFIRMATION OF TEACHING POINT 1

QUESTIONS

- Q1. Name three types of trekking poles.
- Q2. Name three criteria to consider when selecting trekking poles.
- Q3. What are the advantages of using trekking poles?

ANTICIPATED ANSWERS

- A1. Three types of trekking poles are ski poles, wooden walking sticks and telescoping trekking poles.
- A2. The criteria to consider when selecting trekking poles are telescopic adjustment, grips, anti-shock system, baskets and tips.
- A3. Trekking poles may help prevent aches and pains. Poles are useful to help stabilize heavy loads and to negotiate trails. Besides providing better balance, poles reduce the amount of stress on the back, legs and especially the knees. The poles absorb some of the impact the body would have to endure.

Teaching Point 2

Explain Scrambling

Time: 5 min

Method: Interactive Lecture

Scrambling is a term used to describe making one's way over rough, uneven terrain and rocks by climbing or crawling. Scrambling usually requires the use of both hands and feet.

The following should be considered when using the scrambling technique:

- Test handholds and footholds before committing bodyweight.
- Keep the lower body close to the rocks.
- Use the hands to help maintain balance.
- Use large muscles in the legs to support body weight.
- Always maintain three points of contact with the rocks.



Figure 11 Scrambling Technique

*Talisman Newsletter, 2006, Merry Christmas, Copyright 2007 by Talisman Mountaineering Activities Scotland.
Retrieved 17 April 2007, from <http://www.talisman-activities.co.uk/downloads/newsletters/newsletter4/newsletter4.htm>*



When scrambling and facing difficulty, take a moment to catch your breath. Study your route options and always identify a way to turn back.

CONFIRMATION OF TEACHING POINT 2

QUESTIONS

- Q1. What is scrambling?
- Q2. Which muscles should be used to support body weight?
- Q3. How many points of contact should be kept with the rocks when scrambling?

ANTICIPATED ANSWERS

- A1. Scrambling is a term use to describe making one's way over rough, uneven terrain and rocks by climbing or crawling. Scrambling usually requires the use of both hands and feet.
- A2. The leg muscles should support body weight.
- A3. Three points of contact should be kept with the rocks when scrambling.

Teaching Point 3

Explain Boulder Hopping

Time: 5 min

Method: Interactive Lecture

Boulder hopping is when one uses speed and momentum to lightly hop from boulder to boulder using arms or trekking poles to stay balanced.

The following should be considered when boulder hopping:

- Plan your route. Larger boulders are more stable.
- Use your hands for stability.
- Keep your knees bent and relaxed.
- Control speed. Lightly hop.
- If one begins to lose balance, move forward, stepping lightly from foot to foot until balance is regained.



Figure 12 Boulder Hopping With Trekking Poles

Great Outdoor, 2006, Hiking the Forgotten End of the AT, Copyright 2006 by Greatoutdoor.com. Retrieved 12 April 2007, from <http://www.greatoutdoors.com/go/photos.jsp?title=hikingtheforgottenendoftheat&imag=1>



If one wants to practice the boulder hopping technique, medium sized rocks are the best. Practice without a backpack. If one needs to carry a backpack, it should be as small as possible.

CONFIRMATION OF TEACHING POINT 3**QUESTIONS**

- Q1. What are the two elements used when boulder hopping?
- Q2. Describe boulder hopping.
- Q3. What should you do when you lose your balance?

ANTICIPATED ANSWERS

- A1. When boulder hopping one uses speed and momentum.
- A2. Boulder hopping is when one lightly hops from boulder to boulder using arms or trekking poles to stay balanced.
- A3. If one begins to lose balance, move forward, stepping lightly from foot to foot until one regains balance.

Teaching Point 4**Explain Methods for Crossing a Scree**

Time: 15 min

Method: Interactive Lecture

A scree is a mass of fine, small rocks that are often found above the tree line on mountain slopes. When dealing with a scree, caution is the first rule.



Figure 13 Scree

East Riding of Yorkshire Council, E Riding media library-England North, Copyright 2007 by School Improvement Service, East Riding of Yorkshire Council. Retrieved 17 April 2007, from http://www.eriding.net/media/england_north.shtml



Moving on a scree should be avoided, if possible.

TRAVERSING A SCREE

Traversing means walking obliquely or crossing in a sideways movement.

Walking on a scree may be very slippery. When traversing a scree, a planned zig-zag path is the best option. The planned route should be broken down in small sections. One should keep the pace controlled and remember that speed can only mean greater risk.

Walking Sideways. Walking sideways will provide more contact between the long side of the foot and the slope to give better stability.

CLIMBING ON A SCREE

One should avoid climbing up a scree, if possible as it can be very exhausting. If there is no other option, the following tips should be considered:

- Keep to the sides of the scree. The movement of the scree is slower and larger boulders can be found there.
- Aim to keep your feet horizontal. If the scree is small enough, kick the toes into the slope (like in snow).
- Climbing with the feet spread-eagled will help put weight on the instep of each boot.
- Take small steps to reduce the strain on the legs. This also reduces the chances of slipping.
- Legs should be bent at the knee to support the body.

DESCENDING ON A SCREE

When descending a scree, one should keep the weight on the heels and take short steps. One's back should be straight and the knees should be slightly bent to absorb stress and improve balance.

The following should be considered when descending a scree:

- Dig the heels into the slope.
- Use the hands to stay steady.
- Relax the knees and keep moving.

CONFIRMATION OF TEACHING POINT 4

QUESTIONS

- Q1. What is a scree?
- Q2. What does climbing with the feet spread-eagled help with?
- Q3. What actions can help make a scree descent safer?

ANTICIPATED ANSWERS

- A1. A scree is a mass of fine, small rocks that are often found above the tree line on mountain slopes.
- A2. Climbing with the feet spread-eagled will help put weight on the instep of each boot.
- A3. The following actions can make the descent safer: dig the heels into the slope, use the hands to stay steady and relax the knees and keep moving.

Teaching Point 5**Explain Crossing Water Obstacles**

Time: 10 min

Method: Interactive Lecture

CROSSING RIVERS

Crossing rivers can be very challenging depending on the time of the year (e.g. spring when snow melts into streams and rivers). A plan should be established before crossing a river.

Choose a Place to Cross. The safest place to cross is where the water is calm and no deeper than the height of one's hips. Such conditions can be found around rivers bends, where the stream widens and slows to make the turn. The darker (and greener) the water, the deeper it is.

The following should be avoided:

- turbulence that causes white water;
- dark water; and
- a powerful current.

Best Time to Cross. Early in the morning is the best time to cross. Rivers run slower in the morning because the water is colder at night. If conditions appear dangerous, walk upstream in search of a safer option. Always cross with caution.

Wading Across a River. Wading across a river is the safest option. When crossing, always face upstream, diagonal to the current.

If crossing in a group, the strongest people should be at the end and link arms. The group should move slowly in a line, diagonal to the current.

Trekking poles can be used to wade across a river. They will help with maintaining balance.



When crossing a river, to keep boots dry, take them off and wear sport sandals. If one does not have sport sandals, remove socks and boot liners, put boots back on and cross the river.

Hopping. Hopping is a technique used with rocks and will help one cross a river and stay dry. The following should be considered when hopping:

1. Plan the route. Evaluate the steps to take.
2. Decide which rocks are stable.
3. Test steps before committing.
4. If a step is unstable, move quickly to the next one.

Stepping in the water is an option. It is better to step into the water and get wet feet than to fall into it.

Crossing Rivers Using a Wooden Bridge or Ropes. Wooden bridges range from constructed bridges to logs placed across a stream. Always test a bridge first to see if it is fixed and to assess its stability. Crossing a log should be done one person at a time since a little weight can dislodge the log. If a bridge or a log is too narrow, unstable or high, shuffle across in a sitting position.



Unless trained in river rescue, hand-held rope should not be used. If a rope is fixed in place, it can be used to hold on to. Avoid getting tangled in the rope. Carabiners shall not be used to attach a person to the rope.

WATERLOGGED GROUND

Avoid crossing waterlogged ground if possible. It can be a very unpleasant experience.

If there is no other way around, one should plan a route through it. Footsteps of previous trekkers can tell how deep and hard the soil is.

Natural Hard Spots. When planning a route, aiming for hard spots in the ground can save some time. Trees and shrubs might indicate a solid piece of ground. Large rocks and clumps of hard grass are also good indicators. Trails. Sometimes, trails may go across waterlogged ground. Frequently used trails will often have small wooden pathways (looking like short bridges) built to help facilitate the crossing. Bridges made of fallen logs may also be used.

Trails. Sometimes, trails may go across waterlogged ground. Frequently used trails will often have small wooden pathways (looking like short bridges) built to help facilitate the crossing. Bridges made of fallen logs may also be used.



When crossing waterlogged grounds, boots should be tightly laced. Suction of mud may pull at the boots.

CROSSING ICE AND SNOW

Reading the Snow for a Safe Route. When planning a route, it is best to avoid rocky places. Rocks absorb heat causing the snow near them to melt faster. The soft snow around may not be firm enough to hold someone's weight. Before using a path, test the snow with trekking poles to prevent injuries. It is best to cross a large snowfield early in the morning when the snow is harder. As the sun goes up and becomes more powerful, snow melts unevenly and creates soft spots.

Ascending on Snow. When walking on snow, the conditions will govern the route. A new route may be created to ascend safely. Zig-zags may also be an option. If it is easier to go straight up, one should kick the snow several times to make solid steps to stand on. Before standing on these steps, one should always test body weight.



Trekking uphill through snow can be very exhausting. It is recommended to plan twice as much time to complete this kind of trek. Take breaks as required.

Crossing Frozen Water. Crossing frozen water requires caution. When crossing ice, one should use trekking poles to probe for holes or test the snow. On frozen water, do not necessarily rely on old footsteps. The route may not be safe if they are a few days old. Always test before advancing.



Ice is thinner in early winter and spring. During these seasons, one should try to go around any frozen water.

CONFIRMATION OF TEACHING POINT 5**QUESTIONS**

- Q1. When crossing water, what type of water should be avoided?
- Q2. How can someone cross a bridge or a log when it is too narrow, unstable or high?
- Q3. When planning a route covered in snow, why is it safer to avoid rocky places?

ANTICIPATED ANSWERS

- A1. When crossing water, turbulence that causes white water, dark water, and a powerful current should be avoided.
- A2. A person can cross a bridge using a sitting position and shuffling across.
- A3. Rocks absorb heat causing the snow near them to melt faster. The soft snow around them may not be firm enough to hold one's weight.

END OF LESSON CONFIRMATION**QUESTIONS**

- Q1. Name three criteria to consider when selecting trekking poles.
- Q2. What is scrambling?
- Q3. When is the best time to cross a river?

ANTICIPATED ANSWERS

- A1. The criteria to consider when selecting trekking poles are telescopic adjustment, grips, anti-shock system, baskets and tips.
- A2. Scrambling is a term used to describe making one's way over rough, uneven terrain and rocks by climbing or crawling. Scrambling usually requires the use of both hands and feet.
- A3. The best time to cross a river is early in the morning. Rivers run slower in the morning because the water is colder at night.

CONCLUSION

HOMEWORK/READING/PRACTICE

N/A.

METHOD OF EVALUATION

N/A.

CLOSING STATEMENT

Knowing how to cross obstacles is a brief introduction to the world of trekking. It is also a good opportunity for the cadets to be challenged and to develop trekking skills. Crossing obstacles is the first step toward fun and challenging expeditions.

INSTRUCTOR NOTES/REMARKS

The cadets shall participate in a confirmation activity for this EO during the Navigation/Trekking FTX.

REFERENCES

C0-078 Mountain Equipment Co-op. (2007). *Lear: Packs and Poles*. Retrieved 28 February 2007, from <http://www.mec.ca>.

C0-111 (ISBN 978-0-9740820-2-8) Tawrell, P. (2006). *Camping and Wilderness Survival: The Ultimate Outdoors Book* (2nd ed.). Lebanon, NH: Leonard Paul Tawrell.

C0-145 OutdoorPlaces.com. (2004). Buying Guides, Trekking Poles. Retrieved 17 April 2007, from http://www.outdoorplaces.com/gear/buying_guide.htm.

C2-042 (ISBN 0-7566-0946-1) Berger, K. (2005). *Backpacking & Hiking*. New York, NY: DK Publishing, Inc.

C2-051 (ISBN 978-0-7153-2254-3) Bagshaw, C. (Ed.). (2006). *The Ultimate Hiking Skills Manual*. Cincinnati, OH: David & Charles.



ROYAL CANADIAN ARMY CADETS

RED STAR

INSTRUCTIONAL GUIDE



SECTION 1

EO M224.01 – DESCRIBE IMMEDIATE ACTIONS TO TAKE WHEN LOST

Total Time:

60 min

PREPARATION

PRE-LESSON INSTRUCTIONS

Resources needed for the delivery of this lesson are listed in the lesson specification located in A-CR-CCP-702/PG-001, Chapter 4. Specific uses for said resources are identified throughout the Instructional Guide within the TP for which they are required.

Review the lesson content and become familiar with the material prior to delivering the lesson.

PRE-LESSON ASSIGNMENT

N/A.

APPROACH

An interactive lecture was chosen for TP1 to TP3 to present basic or background material.

An in-class activity was chosen for TP4 as it is an interactive way to reinforce the actions to take when lost, to provoke thought and to stimulate interest among cadets.

INTRODUCTION

REVIEW

N/A.

OBJECTIVES

By the end of this lesson the cadet shall be expected to describe the immediate actions to take when lost.

IMPORTANCE

It is important for cadets to have the ability to take action when lost as to increase their chances of survival.

Teaching Point 1**Identify S.T.O.P. Principles**

Time: 10 min

Method: Interactive Lecture



Read to the cadets the *Cadence* article located at Annex A as the introduction to this TP. This article is intended to grab the cadets' attention and emphasize the importance of the actions to take when lost, highlighting the possibility that any cadet can get lost in the field.

It is important to note the cadet was found because of her training.



Once the article in Annex A has been read to the cadets, open the first part of the lesson by questioning the cadets on the following:

Q1. How did cadet Stephanie Leger become lost?

Q2. What action did she take upon accepting the fact that she was lost?

Answers the cadets provide will not be corrected, however they will be used as a means to get the cadets thinking about what they should do in such a situation. At the end of this TP the previous questions will be asked again to recognize any differences in answers.

Emphasize the importance of the S.T.O.P acronym as the first action to take upon recognition of becoming lost. Follow up this short story with a more detailed explanation of the S.T.O.P acronym with the information provided.

Getting lost can be as simple as leaving a hoochie to go to the latrine and becoming disoriented as experienced by cadet Stephanie Leger, or by following an incorrect compass course on a trek. Once it is determined that one is lost the best thing to do is to stay in one place, keep calm and try to gather information to determine one's location. The first 30 minutes of being lost is when people panic and tend to make the biggest mistakes. Following the acronym S.T.O.P. – Sit, Think, Observe, and Plan will help a lost cadet to think through the situation and make good decisions.

S.T.O.P.

Sit. Sit where you are! Do not panic. Many lost people waste valuable energy and risk injury by panicking – running aimlessly, continuing to travel after dark, or walking in circles. If a lost person decides to wander in an attempt to find their location, in most cases they will become more lost, increasing the distance between the known points of their course. This wandering will only increase the size of the search area, increasing the time it will take for a rescue team to locate an individual. As long as there is no immediate danger, stay in one place.

Think. Think about immediate and future dangers and the factors involved in the situation. Consider the time of day, personal physical condition, and the last time water or food was consumed. Try to list the options that are available to you.

Observe. Observe and listen for the signals of rescuers. Study the immediate environment, determining weather, terrain and resources available. Look around in the immediate area for a shelter location, fresh drinking water, and for clues of the current location.

Plan. Plan the best course of action – maybe it is close to dark and consideration should be given to setting up shelter, finding water or starting a fire. Include how to signal rescuers in the plan.



Once the S.T.O.P. acronym is understood, ask the following questions again in reference to the *Cadence* article in Annex A.

Q1. How did cadet Stephanie Leger become lost?

Q2. What action did she take upon accepting the fact that she was lost?

The cadets should now have a better understanding of what cadet Leger went through and the actions she took. The anticipated answers are listed below.

A1. She had wandered from her site and as a result of the approaching nightfall she was unable to find her campsite.

A2. When she realized she was lost, she followed the acronym S.T.O.P—Sit, Think, Observe, Plan.

Use their new answers and form a correlation between their previous answers. Emphasize again the importance of the S.T.O.P acronym as the first action to take when lost.

CONFIRMATION OF TEACHING POINT 1

QUESTIONS

Q1. When a person is lost, when do the biggest mistakes generally occur?

Q2. What does the acronym S.T.O.P. mean?

Q3. What should one observe?

ANTICIPATED ANSWERS

A1. The biggest mistakes occur in the first 30 minutes of being lost.

A2. Sit, Think, Observe and Plan.

A3. When lost, a cadet should observe the immediate environment, weather, terrain and resources available. Look for a shelter location, fresh drinking water, and for clues of the current location.

Teaching Point 2

Discuss How to Control Fear and Panic When Lost

Time: 10 min

Method: Interactive Lecture



Many cadets will have fears of various things. Take the opportunity in this TP to bring to light some of the cadets' fears.

1. Open this TP by conveying to the cadets a personal fear (e.g. heights). This should open the door, encouraging the cadets to answer the following questions.
2. Question the cadets on what some of their fears are (fears can be of any type) and record them on flipchart paper/chalk board/whiteboard.
3. Categorize their fears in similar groups.

To feel fear is normal and necessary. It is nature's way of giving a person an extra shot of energy or adrenaline. Fear is a very normal reaction for people faced with an emergency which threatens their life.



Providing the information below discuss how the effects of fear and panic may affect a person.

EFFECTS OF FEAR AND PANIC

How individuals react to fear depends more on one's state of mind than on the situation. In any stressful, unplanned, or threatening situation, fear may overpower rational thinking and can ruin the chances of survival. Fear may also improve chances of survival. Since something can usually be done to improve any situation, accepting fear as a natural reaction to a stressful situation could lead to constructive behaviour and could increase one's chance of survival.



Providing the information below discuss how the sense of hopelessness contributes to fear.

FACTORS THAT CONTRIBUTE TO FEAR

The feeling of helplessness and the sense of hopelessness are factors that contribute to the sense of fear. Fear must be recognized, accepted, and if possible, used to one's advantage by channelling the adrenaline towards the tasks at hand. The effects of fear can be battled by identifying each factor, understanding and coping with it.



Providing the information below discuss each category of fear and ask the cadets what are some ways they may personally see themselves dealing with and overcoming each fear.

DEALING WITH FEAR

There are many common fears that arise when lost in the field. Addressing and understanding these fears may help one to survive for a prolonged period when lost. The list below explains how to deal with each fear.

Fear of the Unknown. What is out there? What is going to happen to me? Where is it safe? By accepting this fear as normal, one can remain calm and begin to answer each question. Do not criticize yourself for having critical or negative thoughts, just concentrate on and resolve each question or problem calmly and confidently.

Fear of Personal Weakness. This leads to a negative attitude and promotes behaviour to give up. Everyone can do something, no matter how bad the situation. Have confidence in the equipment that may be carried and one's skill to use it. Compare the current situation to similar situations learned about in the past to get through.

Fear of Discomfort. This causes people to continue into a bad storm in order to try to return to the security of a base camp where food and warmth are plenty, instead of stopping and making a safe, although uncomfortable, emergency shelter for the night before they are soaked, exhausted, hungry and hypothermic.

Fear of Being Alone. Even the independent can feel the effects of loneliness unless steps are taken to adapt to, and deal with the isolation. A strong imagination and sense of humour will help.

Fear of the Dark or Animals. People with phobias can easily imagine their worst nightmares coming true, especially in the stressful survival situation. Again, approach each fear with an action plan and an understanding of this fear in context with the whole situation.

Fear of Suffering or Death. This may be the strongest ally in survival. Keep the thought that one must act to survive. By accepting this possibility, and not dwelling on it, one can determine if their plans will provide them with security in their current situation. Have confidence in the rescuers abilities to locate a person.

CONFIRMATION OF TEACHING POINT 2

QUESTIONS

- Q1. How does fear affect a cadet when lost?
- Q2. What factors contribute to fear?
- Q3. How does the fear of discomfort affect cadets?

ANTICIPATED ANSWERS

- A1. Fear can overpower rational thinking and could ruin the chances of survival. It may also improve them.
- A2. Helplessness and the sense of hopelessness contribute to fear.
- A3. This causes people to continue into a bad storm in order to try to return to the security of a base camp, instead of stopping and making a safe shelter to rest in.

Teaching Point 3

Identify the Five Elements of Survival

Time: 10 min

Method: Interactive Lecture



The instructor shall introduce this TP as the five elements of survival and relate the information to what the cadets will be trained on in further lessons (e.g. identify emergency shelters, lighting fires and cooking food).

FIVE ELEMENTS OF SURVIVAL

After successfully completing the S.T.O.P. action and recognizing a survival situation, the lost individual shall take inventory of all the food and equipment on hand and proceed to implement the five elements of survival. These are listed in order of priority.

1. **Attitude.** Maintaining a positive attitude is essential. One can survive by staying calm, using all available resources, and prioritizing personal needs.
2. **Shelter.** A shelter is designed to provide protection from the weather and, depending on the conditions, protect a person from either hot or cold temperatures. Hypothermia and hyperthermia are two of the greatest dangers in a survival situation. A proper shelter can help prevent these from occurring. In a desert scenario, for example, the goal is to stay under a shelter, shaded from the effects of the sun. In cold weather situations, the shelter will provide insulation.
3. **Water.** Water is the most essential nutrient for the human body. Even when thirst is not extreme it can dull your mind. Lack of water will slowly degrade the ability to survive. With adequate shelter and water you can survive for weeks.
4. **Fire.** In a survival situation, fire provides heat and light, and signals to rescuers. Cold weather not only lowers the ability to think, but it also lowers one's will to do anything. Even a few degrees drop in body temperature can affect the ability to make reasonable decisions.

5. **Food.** Individuals in good physical condition can go for many days or even weeks without food. Your goal in a wilderness survival situation is to be located in the shortest time possible, so in most cases you will be located long before food becomes a survival issue. However it is always important to prepare for the worst and find ways to supply the body with substance, through berries, fish, animals, birds, etc.

CONFIRMATION OF TEACHING POINT 3

QUESTIONS

- Q1. What are the five elements of survival?
- Q2. What is the one essential nutrient the body requires to function?
- Q3. What does a shelter provide?

ANTICIPATED ANSWERS

- A1. Attitude, shelter, water, fire and food.
- A2. Water.
- A3. Shelter provides protection from the weather and, depending on the conditions, protects you from either hot or cold temperatures.

Teaching Point 4

Develop a Plan

Time: 20 min

Method: In-Class Activity

ACTIVITY

OBJECTIVE

The objective of this activity is to have the cadets apply the actions to take when lost to a given scenario.

RESOURCES

- Pen and/or pencils (one per cadet);
- Flip chart marker (one per group); and
- Flip chart paper (one sheet per group).

ACTIVITY LAYOUT

Groups shall be placed apart discouraging distraction between groups.

ACTIVITY INSTRUCTIONS

1. Divide the cadets into groups of no more than four.
2. Give each group a marker and a piece of flipchart paper.
3. Present a scenario or assign a different one to each group and allow the cadets 10 minutes to employ the S.T.O.P. acronym to a scenario provided.

4. Allow each group two minutes to present their plan to the other groups.
5. After the groups have finished presenting the instructor will provide feedback on the scenario. Feedback should summarize that attempting each path could cause a cadet to get more lost. Applying the S.T.O.P. actions will increase the chances that the cadet is found in a timely manner.

Lost Cadet (Scenario A)

Your cadet unit is participating in a weekend bivouac FTX where trekking a distance is involved. During the final leg of the trek, your shoelaces become undone and you stop to tie them as the group proceeds around a bend in the path. You are taking much longer than usual. Assuming the group continued on the same path, you take your time enjoying being by yourself on the path. As you round the corner the path opens into a small clearing that splits into four different routes. Concerned you will get into trouble by leaving the group you decide to try one of the routes and speed to catch up.

While travelling down the path you begin to realize this is probably not the correct route. The trek began during the late afternoon and you can see the sun is now getting low in the sky. You have travelled quickly on this path for a short period of time, when you realize you have taken the wrong path. You reassess your location and figure you must have made a mistake at the clearing. You head back on the path to the clearing hoping someone returned for you. Upon reaching the clearing no one is waiting for you. It is close to dark and there are three paths, one of which leads to the bivouac site.

You are lost, what should you do?

Lost Cadet (Scenario B)

Your cadet unit's Silver and Gold Star cadets have just finished an extensive three-day trek. The trek covered over 30 km and now everyone is resting at the rendezvous point for the arrival of the bus to transport all cadets back to the home unit. It is mid-afternoon and many cadets are relaxing, resting their sore, exhausted bodies. The cadet WO is tasked to maintain a watch on all cadets and set boundaries inside which the cadets must remain.

When the bus arrives many of the cadets are eager to load the equipment and board the bus in anticipation of going home. After the bus is loaded, the cadet WO makes a quick count confirming all cadets are on the bus.

When the cadets were told they could go and rest while awaiting the arrival of the bus, you decided to go for a quick nap. Proceeding to the edge of a clearing, you found some shrubs that you rested your pack against. Using it as a back rest, you quickly dozed off. As time passed you awoke from your nap and proceeded to the waiting area. Moving from the shrubs back to the clearing, you are shocked to find no one there.

The shock of being left alone is a scary thought. Your initial instinct was to walk out; however, you have no idea where you are and you are not familiar with the route the bus took. You were dropped off 30 km away and trekked here totalling three days travel.

What should you do?

Lost Cadet (Scenario C)

It is early September and your cadet unit has begun training for the orienteering competition that takes place in late October. You are new to orienteering, however after participating in a few orienteering events during summer training and a few previous practices with your cadet unit, you feel comfortable with your map-reading skills.

The orienteering coach recognizes your developing skill and decides to advance you to the intermediate training level for this practice. As you set out on the course, you realize that this will be more difficult than your previous orienteering practices. Travelling routes you have chosen, you find that the markers are placed in more difficult locations and the terrain the route crosses is more difficult to judge.

Enroute to your fourth control point you exit from a path and are faced with crossing a small river, the path looks to continue on the other side. The river appears to be rather deep. You decide to travel down the edge to find a shallow place to cross. After crossing you try to locate the path you saw to continue on course. You pace the side of the river for some time before finding the path you believed to be the correct route.

Continuing on course, you get the feeling you have travelled too far, however, you continue to move farther ahead. After a period of time you realize this is not the area you should be in at all—you must have taken the wrong path back by the river. The vegetation has changed and does not match what you see on the map. Stopping and inspecting the surrounding area you realize you have no idea where you are or where you have travelled. You are lost.

What should you do?

SAFETY

N/A.

END OF LESSON CONFIRMATION

The cadets' participation in the activity in TP4 will serve as the confirmation of this lesson.

CONCLUSION

HOMEWORK/READING/PRACTICE

N/A.

METHOD OF EVALUATION

N/A.

CLOSING STATEMENT

Having an understanding of the immediate actions to take when lost and implementing them will help cadets increase their survival chances.

INSTRUCTOR NOTES/REMARKS

N/A.

REFERENCES

C2-004 (ISBN 1-896713-00-9) Tawrell, P. (1996). *Camping and Wilderness Survival: The Ultimate Outdoors Book*. Green Valley, ON: Paul Tawrell.

C2-016 (ISBN 0-517-88783-5) Curtis, R. (1998). *The Backpacker's Field Manual: A Comprehensive Guide to Mastering Backcountry Skills*. New York, NY: Three Rivers Press.

CADENCE ARTICLE

Cadence • Issue 4 • Winter • 2001

Forum

New ideas, best practices
and lessons learned



Sgt Stephanie Leger learned more than she bargained for on her survival instructor's course.

SHE HAD
SEEN THE
HELICOPTERS;
HOWEVER,
SHE FELT
THEY COULD
NOT SEE HER
BECAUSE SHE
WAS DRESSED
IN COMBAT
CLOTHING.

LOST AND FOUND

By Capt Jon MacDonald

Sgt Stephanie Leger learned a lot more than she expected on her six-week survival instructor's course at the air cadet summer training centre in Greenwood, NS, this past summer. So did the cadet movement.

The fourth-year air cadet from 101 Royal Canadian Air Cadet Squadron in Moncton, NB was lost for 23 hours on her solo exercise in Cloud Lake, NS. But her story had a happy ending. And lessons were learned.

On the day of her solo exercise, Cadet Leger had not returned to her campsite by the end of the day. After searching for a few hours, staff notified the authorities and later, her parents. It was a call that any parent would dread. The Leger's 16-year-old daughter had been missing for 14 hours.

Cadet Leger's mother, Bernice, immediately flew to Greenwood. The training centre had organized a van and driver, accommodations, and a padre. Mrs. Leger was briefed on the situation and, at her request, was brought to Cloud Lake where the search was in progress. She was impressed to see some 200 people involved with the search efforts including personnel from the training centre, the RCMP, 14 Wing Greenwood, the Emergency Measures Organization and ground search and rescue teams from across the province. There were helicopters from 14 Wing and the Department of Natural Resources, as well as several tracking dogs.

It was late afternoon when Cadet Leger was found in good spirits and physical condition. She told the searchers that she had strayed from her site and was unable to relocate it, partly because it was getting dark. When she realized she was lost, she stayed where she was until she was found. Following a happy and tearful reunion with her mother, waiting paramedics checked her medical status, verified later at the local hospital.

The incident resulted in some valuable lessons. Cadet Leger said afterwards that she had seen the helicopters; however, she felt they could not see her because she was dressed in combat clothing. Little consideration had been given to the fact that combat clothing is designed to keep someone hidden in the bush. Given that



Cadet Leger embraces her mother after her ordeal.

combat clothing is practical for the course, Sgt Leger suggested that cadets carry something reflective or brightly coloured for potential emergency situations.

Searchers found Cadet Leger because she used the safety whistle she was given. However, whistles with a much greater range are available and are now being considered.

As well, the communication procedures and equipment at Cloud Lake were not adequate to handle the extensive search requirements. This is also being reviewed.

Some of the best lessons come from Sgt Leger herself. She has experienced what few people will, and we can learn from what she tells us. She says, "When you realize you are lost the first thing is to stop and sit, observe your surroundings and plan anything you will need such as shelter, fire, food and so on. This is exactly what I did. The hardest part of the ordeal was not to let fear conquer my mind, especially at night. A trick to staying calm at night is to sleep. You have to keep saying to yourself that someone will eventually find you, maybe not today or tomorrow but eventually."

She believes that when you're lost in the bush and alone with your mind, you have to use it to your advantage. "Your mind is a very powerful thing. If you think of all the horrible things that could happen, you'll get nothing accomplished. If you're hungry, convince yourself that you're not hungry! Make yourself laugh!

Talk to rocks, trees...anything. I was lucky enough to have a 'pet' squirrel! I told him that he could be my buddy for now but in a few days, if I wasn't found, he'd be my lunch. While doing this, you almost forget you are lost. Even if it is for only a second, it really helps a lot."

The incident was also proof that our training works. Maj Ken Mayo, the chief training officer for Cloud Lake says, "Cadet Leger acted calmly and used her training towards staying safe for that night. She stayed calm throughout and kept to the general area where she was when she realized she was lost. The training that we give our cadets is effective and useful in real world situations."

Sgt Leger agrees. "The outcome could have been worse, but it wasn't — thanks to the training I received prior to this exercise. I'd highly recommend this course to any cadet."

Sgt Leger and her parents are thankful to those who helped in the search. They believe that "an exemplary team effort was the key to the happy ending." The cadet adds, "No-one knows how seeing them felt when they found me!"

Cadet Leger stayed to finish her course. Her parents agreed with her choice. Two days later, they sent her younger brother to the three-week physical education and recreation training course. As Mrs. Leger put it, "everyone got back on the horse." 🐾

**"THE HARDEST
PART OF THE
ORDEAL WAS
NOT TO LET
FEAR CONQUER
MY MIND,
ESPECIALLY
AT NIGHT."**

– Capt MacDonald is the regional public affairs officer, Atlantic

**"IF YOU'RE
HUNGRY,
CONVINCE
YOURSELF
THAT YOU'RE
NOT HUNGRY!
MAKE YOUR-
SELF LAUGH!
TALK
TO ROCKS,
TREES...
ANYTHING."**



ROYAL CANADIAN ARMY CADETS

RED STAR

INSTRUCTIONAL GUIDE



SECTION 2

EO M224.02 – IDENTIFY THE SEVEN ENEMIES OF SURVIVAL

Total Time:

30 min

PREPARATION

PRE-LESSON INSTRUCTIONS

Resources needed for the delivery of this lesson are listed in the lesson specification located in A-CR-CCP-702/PG-001, Chapter 4. Specific uses for said resources are identified throughout the Instructional Guide within the TP for which they are required.

Review the lesson content and become familiar with the material prior to delivering the lesson.

Copy the handout located at Annex A for each cadet.

PRE-LESSON ASSIGNMENT

N/A.

APPROACH

An interactive lecture was chosen for this lesson to orient the cadets to the seven enemies of survival and to present background material.

INTRODUCTION

REVIEW

N/A.

OBJECTIVES

By the end of this lesson the cadet shall have identified the seven enemies of survival.

IMPORTANCE

It is important for cadets to understand the seven enemies of survival so they have the knowledge to combat them and increase their chances of survival.

Teaching Point 1

Explain the Psychology of Wilderness Survival

Time: 5 min

Method: Interactive Lecture

THE PSYCHOLOGY OF WILDERNESS SURVIVAL

Research has shown that there are a number of factors that influence survival. Stress can have a negative effect on anyone who finds themselves in a survival situation. Sometimes the stress of becoming involved in a

survival situation can result in people making decisions that defy common sense. The inability to make rational decisions has caused injuries and death among rational, sensible people.

It is only natural for people who have been fed, clothed, and have lived in a world of modern convenience to be fearful of trying to provide for their own basic needs. But humans have the will and intelligence to adapt to almost any natural environment on earth. People are much stronger and more capable than they realize.

Survival is more about quality of spirit and character than it is about physical strength. Sometimes, the physically strongest person is the first to give up, while the weakest may show the most determination.

The most important psychological requirement to wilderness survival is to admit the reality of the situation and to react appropriately.

Remember that it is not feasible to have everything one wants, but one can have everything one needs!



Researchers have shown that children often adapt more easily to survival situations as they have not been conditioned to so much comfort. They are not afraid to get dirty, wet, and make the most fun out of what they do.

CONFIRMATION OF TEACHING POINT 1

QUESTIONS

- Q1. When stressed about being in a survival situation, what do some people forget to use?
- Q2. What is the most important psychological requirement of wilderness survival?
- Q3. Which is more important in a survival situation, spirit and character or physical strength?

ANTICIPATED ANSWERS

- A1. When stressed about being in a survival situation, some people forget to use their common sense.
- A2. The most important psychological requirement of wilderness survival is to admit the reality of the situation and to react appropriately.
- A3. Spirit and character are more important than physical strength in a survival situation.

Teaching Point 2

Identify and Explain How to Combat the Seven Enemies of Survival

Time: 20 min

Method: Interactive Lecture



Challenge cadets to think about what the seven enemies of survival may be. As cadets guess the seven enemies review the points on that enemy as listed below.

GENERAL

Everyone has experienced the seven enemies of survival—pain, cold, thirst, hunger, fatigue, boredom and loneliness, but not many have experienced them to the point of threatening their survival. In a survival situation, these feelings become more severe and dangerous. The more information known about the seven enemies of survival, the better prepared a cadet will be able to combat them, increasing their chances of survival.

Pain. Pain is nature's way of letting the mind know that something is wrong. The mind can postpone the feeling of pain, if the mind and body are distracted doing something else. Once the mind recognizes pain, it can weaken the drive to survive. It can become overwhelming, even if it is not serious or prolonged. Keep spirits up to postpone the feeling of pain.

Cold. Cold is a more of a threat than most people think. Cold lowers the ability to think and distracts people from doing much more than thinking about getting warm. Because cold slows the body down, it is easy to feel the need to sleep. Cold numbs the mind, the body and the will. Stay moving to try to get warm.

Thirst. Thirst is the hidden enemy of survival. Even when someone has a mild thirst, the mind can feel dull. Like pain and cold, if attention is drawn to it, it can lower the drive to survive. Remember to drink water if it is available and safe. The feeling of thirst can fog the mind. One can become dehydrated even when water is available because they forget to drink or do not force themselves to drink. Lack of water leads to dehydration as well as headaches and nausea.

Hunger. The feeling of hunger can affect a person's rational thought. Thirst and hunger can increase the chances of weakening to the effects of cold, pain and fear. This is especially true after three days, when the stomach shrinks and reduces its desire for food.

Fatigue. Even a small amount of fatigue (tiredness) can reduce mental ability. It is easy to become lazy and adopt a careless attitude. Fatigue is one of the biggest dangers to wilderness survival and may be responsible for some deaths. Although there is a real danger of over-exertion, fatigue may be caused by a feeling of hopelessness or frustration. Sleep allows someone to escape from a situation they feel may be too difficult to handle.

Boredom and Loneliness. Boredom and loneliness are two of the toughest enemies of survival because they are unexpected. When there is nothing to do, feelings of boredom and loneliness may creep up. Try to find some way to keep occupied. Working on a plan allows one to be constructive while staying busy. Building amenities for the site or something as simple as singing and talking can keep the cadet's mind occupied.

ACTIVITY

Time: 10 min

OBJECTIVE

The objective of this activity is to become familiar with the seven enemies of survival.

RESOURCES

- Copies of the puzzle located at Annex A (one per cadet); and
- Pens or pencils (one per cadet).

ACTIVITY LAYOUT

N/A.

ACTIVITY INSTRUCTIONS

1. Distribute a copy of the puzzle to each cadet.
2. Ensure all cadets understand how to complete a crossword puzzle (e.g. explain the difference between across and down answers).

3. Allow five to seven minutes for the cadets to complete the puzzle.
4. Correct the puzzle using the answer sheet located at Annex B.

SAFETY

N/A.

CONFIRMATION OF TEACHING POINT 2

The cadets' participation in the activity will serve as the confirmation of this TP.

END OF LESSON CONFIRMATION

QUESTIONS

- Q1. When stressed about being in a survival situation, what do some people forget to use?
- Q2. What are the seven enemies of survival?
- Q3. Why are boredom and loneliness two of the toughest enemies of survival?

ANTICIPATED ANSWERS

- A1. When stressed about being in a survival situation, some people forget to use their common sense.
 - A2. The seven enemies of survival are pain, cold, thirst, hunger, fatigue, and boredom and loneliness.
 - A3. Boredom and loneliness are often unexpected and can creep up on you.
-

CONCLUSION

HOMEWORK/READING/PRACTICE

N/A.

METHOD OF EVALUATION

N/A.

CLOSING STATEMENT

Being in the right frame of mind can make a great difference in how well one adapts in a survival situation. Knowing the seven enemies of survival can greatly increase your chances of combating them, if you become lost.

INSTRUCTOR NOTES/REMARKS

N/A.

REFERENCES

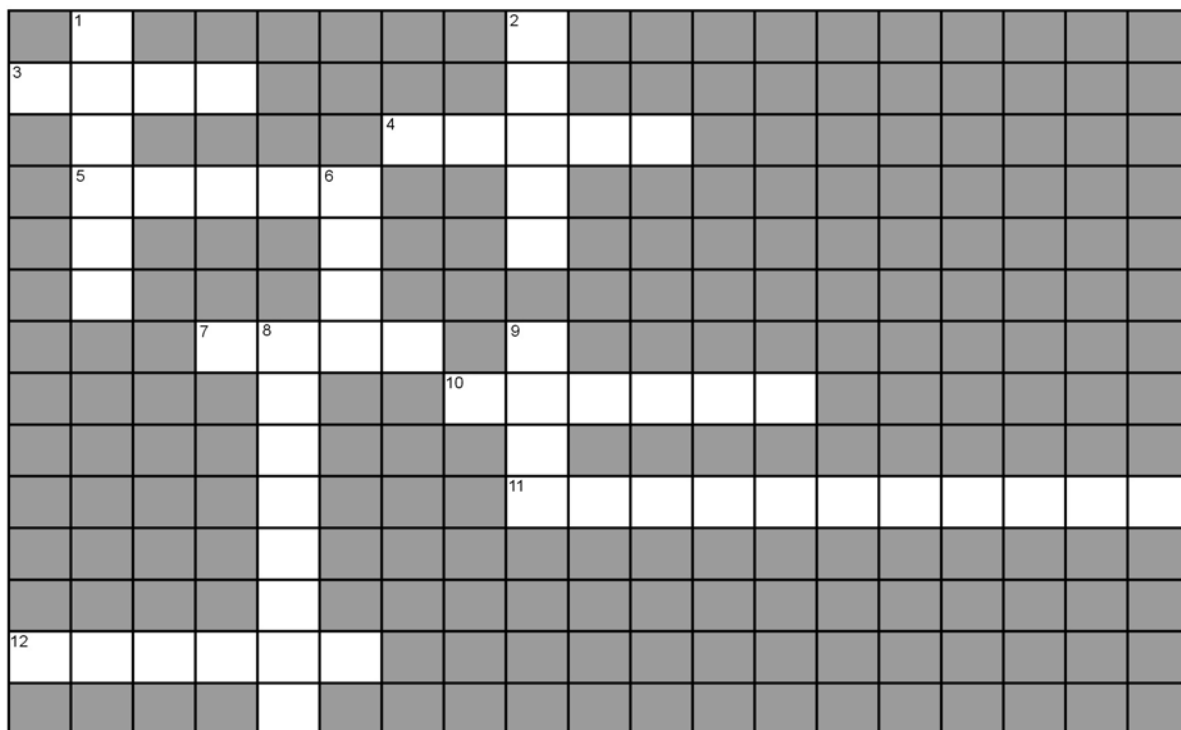
A2-046 B-GA-217-001/PT-001 *Down But Not Out*. (ND). Ottawa, ON: Department of National Defence.

C2-068 (ISBN 0-425-10572-5) Brown, T & Morgan, B. (1983). *Tom Brown's Field Guide to Wilderness Survival*. New York, NY: The Berkley Publishing Group.

C2-069 (ISBN 0-9694132-0-3) Ferri, G. (2000). *The Psychology of Wilderness Survival*. Hanover, ON: Skyway Printing.

THIS PAGE INTENTIONALLY LEFT BLANK

ENEMIES OF SURVIVAL PUZZLE



ACROSS

3. Nature's way of letting the body know that something's wrong.
4. After about ____ days, the stomach will shrink.
5. ____ allows someone to escape from a difficult situation.
7. Singing and talking are great ways to keep the ____ occupied.
10. When cold, keep the body ____.
11. A way to postpone pain.
12. ____ is the hidden enemy of survival.

DOWN

1. Lack of water can lead to dehydration, headaches and ____.
2. When ____, try to find something to stay occupied.
6. Working on a ____ allows one to be constructive while staying busy.
8. Thirst and hunger can ____ the chances of weakening to the effects of cold, pain and fear.
9. The body slows down it is ____.

THIS PAGE INTENTIONALLY LEFT BLANK

ENEMIES OF SURVIVAL PUZZLE – ANSWER KEY

	¹ N								² B										
³ P	A	I	N						O										
	U						⁴ T	H	R	E	E								
	⁵ S	L	E	E	⁶ P				E										
	E				L				D										
	A				A														
			⁷ M	⁸ I	N	D			⁹ C										
				N				¹⁰ M	O	V	I	N	G						
				C					L										
				R					¹¹ D	I	S	T	R	A	C	T	I	O	N
				E															
				A															
¹² T	H	I	R	S	T														
				E															

ACROSS

- Nature's way of letting the body know that something's wrong.
- After about ____ days, the stomach will shrink.
- ____ allows someone to escape from a difficult situation.
- Singing and talking are great ways to keep the ____ occupied.
- When cold, keep the body ____.
- A way to postpone pain.
- ____ is the hidden enemy of survival.

DOWN

- Lack of water can lead to dehydration, headaches and ____.
- When ____, try to find something to stay occupied.
- Working on a ____ allows one to be constructive while staying busy.
- Thirst and hunger can ____ the chances of weakening to the effects of cold, pain and fear.
- The body slows down it is ____.

THIS PAGE INTENTIONALLY LEFT BLANK



ROYAL CANADIAN ARMY CADETS

RED STAR

INSTRUCTIONAL GUIDE



SECTION 3

EO M224.03 – PREDICT WEATHER USING CLOUD FORMATIONS

Total Time:	30 min
-------------	--------

PREPARATION

PRE-LESSON INSTRUCTIONS

Resources needed for the delivery of this lesson are listed in the lesson specification located in A-CR-CCP-702/PG-001, Chapter 4. Specific uses for said resources are identified throughout the Instructional Guide within the TP for which they are required.

Review the lesson content and become familiar with the material prior to delivering the lesson.

PRE-LESSON ASSIGNMENT

N/A.

APPROACH

An interactive lecture was chosen for this lesson to introduce predicting weather using cloud formations as a new subject and to present basic or background material.

INTRODUCTION

REVIEW

N/A.

OBJECTIVES

By the end of this lesson the cadet shall be expected to predict the weather using cloud formations.

IMPORTANCE

It is important for cadets to learn to predict weather using cloud formations so they can factor the weather into their survival plan, if they become lost. The weather will play an important role when selecting the best action to take while waiting for assistance from rescuers and when deciding the type of shelter to seek or construct.

Teaching Point 1**Identify Types of Clouds**

Time: 15 min

Method: Interactive Lecture

TYPES OF CLOUD FORMATIONS

The terms cumulus and stratus are used in most cloud names. In most cases, the height of a cloud will be the prefix (beginning element of a word) and the type will be the suffix (the end element of a word). Discuss the types of cloud formations.



Cloud names come from Latin. Some common words are:

- cirro = high;
- alto = middle;
- nimbus = rain;
- cirrus = curl;
- stratus (as a prefix) = low;
- stratus (as a suffix) = layer; and
- cumulus = pile.

Clouds are classified into two categories based on how they are formed – cumulus and stratus.

Cumulus. The typical clumpy, “puffy” cloud is formed in rising air currents. Cumulus clouds are evidence of unstable air conditions. Cumulus clouds are formed when small areas of rising air cool to the saturation point.

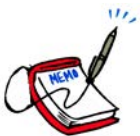
Stratus. These appear “spread out” and in sheets or horizontal layers. Stratus clouds are formed when a layer of moist air is cooled below its saturation point.



Precipitation falls from nimbus clouds.



Cool air can hold less water than warm air. As a given amount of air cools, humidity increases. When the humidity reaches 100 percent, clouds form. This is the saturation point.

FAMILIES OF CLOUDS

This section includes descriptions of clouds found in each family and weather predictions for each.

Cadets should be able to describe the look of each cloud. Weather will be discussed further in TP2.

Clouds are classified into four families – high clouds, middle clouds, low clouds and clouds of vertical development.

High Clouds

These clouds are very high in the sky and are composed of ice crystals. High clouds have the prefix “cirro”. There are three types – cirrus, cirrocumulus, and cirrostratus.

Cirrus. These clouds are wispy and look like cotton candy being pulled. They appear to be whitish wisps of cloud and are usually an indicator of fair weather.



Figure 1 Cirrus Clouds

Brotak, E., Wild About Weather, A Division of Sterling Publishing Co., Inc. (p. 87)

Cirrostratus. These clouds are whitish sheets that completely cover the sky. Cirrostratus clouds are normally see-through. When these clouds are in the sky, one can expect precipitation in a day or two.



Figure 2 Cirrostratus Clouds

Brotak, E., Wild About Weather, A Division of Sterling Publishing Co., Inc. (p. 87)

Cirrocumulus. These clouds are little, white and puffy. They form a huge sheet, covering the sky. When cirrocumulus clouds are in the sky, one can predict fair weather.



Figure 3 Cirrocumulus

Brotak, E., Wild About Weather, A Division of Sterling Publishing Co., Inc. (p. 87)

Middle Clouds

These clouds are in the middle of the sky and are composed of ice crystals or water droplets. Middle clouds have the prefix “alto”. There are two main types – altocumulus and altostratus.

Altocumulus. These clouds are very big and can be white or grey. They appear as a layer or a series of patches of rounded masses. Altocumulus clouds can be seen before fair or bad weather and have little value as an indicator of future weather developments.



Figure 4 Altocumulus

Brotak, E., Wild About Weather, A Division of Sterling Publishing Co., Inc. (p. 87)

Altostratus. These clouds appear as a greyish or whitish sheet that completely covers the sky. The sun can vaguely be seen through it. Altostratus clouds indicate increasing moisture and usually precede precipitation by 24 hours or less.



Figure 5 Altostratus

Brotak, E., Wild About Weather, A Division of Sterling Publishing Co., Inc. (p. 87)

Low Clouds

These clouds are low in the sky and are composed of water droplets. Low clouds are associated with “stratus”. There are three types – stratus, stratocumulus, and nimbostratus.

Stratus. These clouds appear as low, dull, greyish sheets that completely cover the sky (resembling fog). During the day, the sun cannot be seen. They can produce drizzle or very light rain or snow. When deep clouds are above, the rain or snow can be heavier.



Figure 6 Stratus

Brotak, E., Wild About Weather, A Division of Sterling Publishing Co., Inc. (p. 87)

Stratocumulus. These appear as sheets of big puffy white or grey clouds. Stratocumulus clouds often appear in dark patches or rolls and are often thin with blue sky showing through the breaks. Snow or showers of rain are possible and can be heavy.



Figure 7 Stratocumulus

Brotak, E., Wild About Weather, A Division of Sterling Publishing Co., Inc. (p. 87)

Nimbostratus. These appear as dark grey layers of large, puffy clouds. When they produce precipitation, it is in the form of continuous rain or snow. The bottom of this cloud is often hidden by falling rain or snow, which may be heavy.



Figure 8 Nimbostratus

Brotak, E., Wild About Weather, A Division of Sterling Publishing Co., Inc. (p. 88)

Clouds of Vertical Development

These clouds may be very low in the sky. When the temperature is above freezing (higher than zero degrees), they are composed of water droplets. When the temperature is below freezing (lower than zero degrees), they are composed of ice crystals and water droplets. Clouds of vertical development are associated with “cumulus”. There are three types – cumulus, towering cumulus, and cumulonimbus.

Cumulus. These clouds are large, individual puffy clouds. They resemble cauliflower or cotton balls. The bottoms often appear dark and flat. They can often be seen on a warm day. When these clouds are in the sky one can expect fair weather, unless they begin to extend upwards.



Figure 9 Cumulus

Brotak, E., Wild About Weather, A Division of Sterling Publishing Co., Inc. (p. 88)

Towering Cumulus. These clouds build up into high towering masses. They have puffy, white tops but very dark bottoms. Towering cumulus clouds can produce showers and may develop into heavy ice or thunderstorms.



Figure 10 Towering Cumulus

Brotak, E., Wild About Weather, A Division of Sterling Publishing Co., Inc. (p. 88)

Cumulonimbus. These clouds are very dark at the bottom. They extend way up into the atmosphere and have flattened tops. When cumulonimbus clouds are in the sky, one can predict thunderstorms and windy, rainy conditions.



Figure 11 Cumulonimbus

Brotak, E., Wild About Weather, A Division of Sterling Publishing Co., Inc. (p. 89)



The long, narrow white clouds left behind jet airplanes are called contrails. They are formed by the moisture coming out of the engine and condensing in the very cold air.

CONFIRMATION OF TEACHING POINT 1

QUESTIONS

- Q1. What are the three clouds found in the high cloud family?
- Q2. What does an altocumulus cloud look like?
- Q3. What does a nimbostratus clouds look like?

ANTICIPATED ANSWERS

- A1. Cirrus, cirrostratus and cirrocumulus.
- A2. These clouds are very big and can be white or grey. They appear as a layer or a series of patches of rounded masses.
- A3. These appear as dark grey layers of large, puffy clouds.

Teaching Point 2

Discuss How to Predict Approaching Weather Using Clouds

Time: 10 min

Method: Interactive Lecture



Being able to forecast weather using clouds is a great tool in the field. Discuss the signs that clouds give when the weather is going to change.

BAD WEATHER

When the weather is going to **change for the worse**, one will notice several general cloud activities. Signs of change for the worse are:

- Clouds (regardless of their formation) are thickening (darkening), increasing in number or joining together, forming layers, and/or lowering in elevation.
- Clouds are forming banks in the west with winds from the south.
- Clouds are moving in all directions, or contrary to the ground wind.
- Altostratus clouds are darkening and lowering.
- Altocumulus clouds are moving quickly across the sky or forming towers in the morning.
- Cumulus clouds are forming in the morning and stacking in the afternoon or moving from the south or south-west.



A halo around the moon indicates that the weather is going to change for the worse.

GOOD WEATHER

When the weather is going to **change for the better**, one will notice several general cloud activities. Signs of a change for the better are:

- Cloud cover is lifting, becoming lighter and small patches of blue sky are developing.
- Cumulus clouds are forming in the afternoon or floating alone without stacking.
- Stratocumulus clouds are drifting with the prevailing wind and remaining scattered.
- The condensation trail ('contrail') left by high altitude aircraft is dispersing quickly.
- Morning fog is burning off before noon.

THUNDERSTORMS/LIGHTNING

Thunderstorms. Thunderstorms are most common in the summertime. They are formed by cumulus clouds, feeding off warm and moist air. These clouds grow quickly during the day, driven by the heat from the sun. When dark cumulonimbus clouds begin to approach, one can expect a thunderstorm. The big feature of a thunderstorm is lightning.

Lightning. Lightning is an electrical discharge in the atmosphere. When cumulus clouds grow tall, they develop an electrical field. The top of the cloud, where there are lots of ice crystals, is normally positive. The bottom part of the cloud, filled with rain droplets, is normally negative. The ground has a positive charge. An electrical charge builds up and the atmosphere produces lightning.

Thunder. Thunder is the sound made when a lightning bolt heats the air and expands quickly. Since sound moves much slower than light, one can judge how far away a lightning bolt is by counting the seconds between seeing the flash and hearing the thunder. Each three second interval equals about one kilometre.



The fear of lightning is called *astraphobia*. The fear of thunder is called *brontophobia*.



As mentioned in TP1, weather can also be predicted simply from knowing the type of cloud in the sky. Discuss the expected weather for each type of cloud.

HIGH CLOUDS	
Cirrus	Normally an indicator of fair weather.
Cirrocumulus	Expect precipitation in a day or two.
Cirrostratus	Predict fair weather.
MIDDLE CLOUDS	
Altostratus	Normally seen before fair or bad weather. Have little value as an indicator of future weather developments.
Altostratus	Expect precipitation in 24 hours or less.
LOW CLOUDS	
Stratus	Expect drizzle, light rain or snow.
Stratocumulus	Snow or showers are possible and can be heavy.
Nimbostratus	Expect rain or snow.
CLOUDS OF VERTICAL DEVELOPMENT	
Cumulus	Expect fair weather, unless they begin to extend upwards.
Towering Cumulus	Expect showers. May develop into heavy ice or thunderstorms.
Cumulonimbus	Expect thunderstorms and showery conditions.

CONFIRMATION OF TEACHING POINT 2

QUESTIONS

- Q1. What are the common signs of a change in the weather for the worse?
- Q2. What are the two middle clouds and what weather can be predicted when they are seen in the sky?
- Q3. What is lightning?

ANTICIPATED ANSWERS

A1. Signs of change for the worse are:

- Clouds (regardless of their formation) are thickening (darkening), increasing in number or joining together, forming layers, and/or lowering in elevation.
- Clouds are forming banks in the west with winds from the south.
- Clouds are moving in all directions, or contrary to the ground wind.
- Altostratus clouds are darkening and lowering.
- Altocumulus clouds are moving quickly across the sky or forming turrets in the morning.
- Cumulus clouds are forming in the morning and stacking in the afternoon or moving from the south or south-west.

A2.

MIDDLE CLOUDS	
Altocumulus	Normally seen before fair or bad weather. Have little value as an indicator of future weather developments.
Altostratus	Expect precipitation in 24 hours or less.

A3. Lightning is an electrical discharge in the atmosphere. When cumulus clouds grow tall, they develop an electrical field. The top of the cloud, where there are lots of ice crystals, is normally positive. The bottom part of the cloud, filled with rain droplets, is normally negative. The ground has a relatively positive charge. An electrical charge builds up and the atmosphere produces lightning.

END OF LESSON CONFIRMATION**QUESTIONS**

- Q1. What are the three high clouds, including their description and weather prediction?
- Q2. What are the three types of low clouds, including their description and weather prediction?
- Q3. What are the common signs of a change in the weather for the better?

ANTICIPATED ANSWERS

A1. The high clouds include:

- **Cirrus.** These clouds are wispy and look like cotton candy being pulled. They have whitish wisps of cloud and are usually an indicator of fair weather.
- **Cirrostratus.** These clouds are whitish sheets that completely cover the sky. They are normally see-through. When these clouds are in the sky, one can expect precipitation in a day or two.
- **Cirrocumulus.** These clouds are little, white and puffy. They form a huge sheet, covering the sky. When these clouds are in the sky, one can predict fair weather.

A2. The low clouds include:

- **Stratus.** These clouds are low, dull, greyish sheets that completely cover the sky (resembling fog). During the day, the sun cannot be seen. They can produce drizzle or very light rain or snow. When deep clouds are above, the rain or snow can be heavier.
- **Stratocumulus.** These are sheets of big puffy white or grey clouds. They are often in dark patches or rolls and are often thin with blue sky showing through the breaks. Snow or showers of rain are possible and can be heavy.
- **Nimbostratus.** These are dark grey layers of large, puffy clouds. When they produce precipitation, it is in the form of continuous rain or snow. The bottom of this cloud is often hidden by falling rain or snow, which may be heavy.

A3. Signs of change for the better are:

- Cloud cover is lifting, becoming lighter and small patches of blue sky are developing.
- Cumulus clouds are forming in the afternoon or floating alone without stacking.
- Stratocumulus clouds are drifting with the prevailing wind and remaining scattered.
- The condensation trail ('contrail') left by high altitude aircraft is dispersing quickly.
- Morning fog is burning off before noon.

CONCLUSION

HOMEWORK/READING/PRACTICE

N/A.

METHOD OF EVALUATION

N/A.

CLOSING STATEMENT

Being able to use the clouds to predict weather is a great tool when in a survival situation and when in the field. Weather is an important aspect of planning in any survival situation with respect to the type of shelter selected and the best course of action to take.

INSTRUCTOR NOTES/REMARKS

N/A.

REFERENCES

A0-036 A-CR-CCP-121/PT-001 D Cdts 3 (2000). *Royal Canadian Army Cadet Reference Book*. Ottawa, ON: Department of National Defence.

A2-045 A-CR-CCP-263/PT-001/(ISBN 0-9680390-5-7) MacDonald, A.F. & Peppler, I.L. (2000). *From the Ground Up*. Millennium edition. Ottawa, ON: Aviation Publishers Co. Limited.

C2-016 (ISBN 0-517-88783-5) Curtis, R. (1998). *The Backpackers Field Manual: A Comprehensive Guide to Mastering Backcountry Skills*. New York, NY: Three Rivers Press.

C2-072 (ISBN 1-57990-468-8) Brotak, E. (2004). *Wild About Weather*. New York, NY: Lark Books, A Division of Sterling Publishing Co., Inc.

THIS PAGE INTENTIONALLY LEFT BLANK



ROYAL CANADIAN ARMY CADETS

RED STAR

INSTRUCTIONAL GUIDE



SECTION 4

EO M224.04 – IDENTIFY EMERGENCY SHELTERS

Total Time:

60 min

PREPARATION

PRE-LESSON INSTRUCTIONS

Resources needed for the delivery of this lesson are listed in the lesson specification located in A-CR-CCP-702/PG-001, Chapter 4. Specific uses for said resources are identified throughout the Instructional Guide within the TP for which they are required.

Review the lesson content and become familiar with the material prior to delivering the lesson.

Seek out or construct shelters for TP2 and TP3. It is imperative that cadets have a visual example of each shelter. However, it is understood that terrain differences may limit the ability to locate all shelters mentioned.



The definition of leeward is on or towards the side sheltered from the wind (e.g. if the wind is blowing against the front of a car the leeward side would be the rear of the car.)

PRE-LESSON ASSIGNMENT

N/A.

APPROACH

An interactive lecture was chosen for TP1 to TP3 to introduce factors to consider when identifying emergency shelters as a new subject and to present basic or background material.

A practical activity was chosen for TP4 as it is an interactive way to allow cadets to seek out emergency shelters in a natural setting.

INTRODUCTION

REVIEW

The review for this lesson is from the previous lesson M224.01 (Describe Immediate Actions To Take When Lost).

QUESTIONS

- Q1. What does the acronym S.T.O.P stand for?
- Q2. What are the five elements of survival?
- Q3. What is the second element of survival when you find you are lost?

ANTICIPATED ANSWERS

- A1. Sit, Think, Observe, Plan.
- A2. Attitude, shelter, water, fire and food.
- A3. Shelter.

OBJECTIVES

By the end of this lesson the cadet shall be expected to identify emergency shelters that are natural or improvised and ensure their site chosen will provide them with comfort throughout their stay.

IMPORTANCE

It is important for cadets to be able to identify a shelter or construct an emergency shelter because shelter is identified as one of the elements of survival. Construction of a shelter is the second survival element that should be completed once the cadets know they are lost.

Teaching Point 1

Explain Factors to Consider When Selecting a Site for an Emergency Shelter

Time: 15 min

Method: Interactive Lecture



The instruction area for this lesson will meet the factors of site selection as detailed in TP1.

Cadets will be expected to identify a type of shelter by the end of this lesson. Introduce this TP by presenting the cadets with a scenario where they have become lost in the field and they have only a few hours of daylight left.

Shelter is their first concern. The location chosen to demonstrate the selection of a site should meet most if not all considerations when choosing a location. Question the cadets enquiring what they currently think of the location. These questions should get their thoughts thinking about what considerations they would take into account when choosing a site.

Continue this lesson by identifying the rest of the factors and considerations described in TP1.

During the summer months the need for shelter is not always a great concern however it should be. Even in winter a survivor may be tempted to set up a fire the first night rather than tackle the job of building or finding a shelter. When discussing the five elements of survival, shelter is the second survival element, before fire. A shelter provides protection from the elements, particularly wind and precipitation. Shelters improve morale and survival chances by providing comfort, security and a sense of accomplishment.

TERRAIN CONSIDERATIONS

There are Several Factors that Must be Considered When Selecting a Site. Locations to construct a shelter should meet certain criteria, to avoid being awoken during the night due to an over-looked problem.

Select an Area that is Large Enough for the Planned Shelter. Possible sites that are perfect in their natural form may be too small to accommodate the size of one person. Ensure that the site chosen can comfortably, considering the situation, fit oneself for the duration of the survival situation.

Select an Area that is Elevated and Provides Drainage. A site should provide dry footing and drainage of future rains. Keep back from rivers or lakes which may flood after a rain fall.

Identify Sheltered Areas that Protect From Wind, Rain and Sun. Shelter from the wind, rain and sun can be sought from boulders, hillsides, trees or whatever source may be available. In the summer a little breeze will reduce the number of insects and can keep one cool during hot summer days. During winter a shelter will separate the body from the elements and provide warmth. If the entrance of the shelter faces leeward (away from the wind), rain or snow will swirl over and drop inside. If the entrance faces windward, smoke and ashes from the fire will blow into the shelter. Place the back of the shelter into the wind (see Figure 6).

LOCATION CONSIDERATIONS

Proximity to a Water Source that Provides Potable Water and Food from Fishing. The availability of a nearby water source will reduce the amount of energy expended while collecting water. A source of water may also provide fishing grounds that may supply food.

Proximity to a Fuel Source for Fire During Cold Weather. Situating a shelter near a fuel source will reduce the amount of energy required to gather enough fuel for the fire.

Proximity to Building Materials. Although the shelter is an emergency shelter there is always the need to make what is natural more liveable. Situating the shelter near building supplies will reduce the amount of energy required to build and secure the shelter.

Proximity to Animal Trails or Holes. In the wild, the food chain is active. Beware of locating your shelter near the natural paths animals create. Where there are animals, there may be danger.

Select Areas that are Close to or can be Seen by Aircraft From Above. When lost in a wilderness area it is important to remember you have to establish contact with or attract the attention of searchers and rescuers. Staying in a site that is easily seen from above will increase your chances of being rescued.

Estimate the Time Required to Build a Shelter Before Night Fall. Depending on the amount of time available, one may choose to construct a simple emergency shelter for the night. Estimate the amount of daylight left when constructing a shelter by looking at the horizon. If the sun is near the horizon, there is not much daylight left.

The Entrance Should be Sheltered From the Wind and Preferably in the Direction of the Sun. Situating the shelter so the prevailing wind is blowing against the rear will help ensure the occupant will be able to maintain some heat inside. Face the entrance, if possible, into the sun allowing the sunshine into the shelter. This provides heat to the occupant.

CONFIRMATION OF TEACHING POINT 1

QUESTIONS

- Q1. What are three terrain considerations one should take into account when selecting a shelter site?
- Q2. What are three considerations of a site location that one should take into account?
- Q3. Which way should the entrance of a shelter face?

ANTICIPATED ANSWERS

- A1. Select an area that is large enough for the planned shelter, elevated and provides drainage, and helps protect from the wind, rain and sun.
- A2. The location should be in close proximity to a water source that provides potable water and food from fishing. It should also be close to building materials but far from animal trails or holes.
- A3. The entrance should face the leeward side (away from the wind).

Teaching Point 2

Identify Types of Natural Shelters

Time: 5 min

Method: Interactive Lecture



Conduct a tour of actual shelters. Examples help illustrate what each shelter looks like and provide cadets with insight into each shelter's purpose.

Have cadets inspect each shelter type.

TREE HOLLOW

A tree hollow is a good natural shelter that can be used in a hurry when there is little time to construct something more permanent. It is often found under a tree, especially a large conifer. Lower branches hanging over the hollow may form a kind of roof to block out the wind and rain.



Figure 1 Tree Hollow

Berger, K., Backpacking and Hiking, DK Publishing, Inc. (p. 203)

CAVE

A cave is an ideal shelter as it offers a roof, constant temperature and is secure.

Caves are found along cliffs or along coast lines especially if the water levels have receded; however, these caves most likely were formed by wave action. Be cautious of high tide.

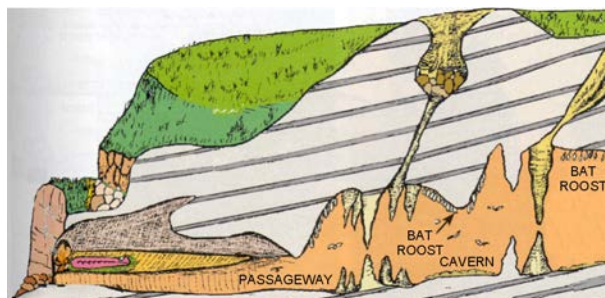


Figure 2 Cave

Tawrell, P., Camping and Wilderness Survival, Leonard Paul Tawrell (p. 409)

ROOT SHELTER

A root shelter will provide good separation from the wind with little preparation. Be cautious as water tends to pool at the base of the roots during a rain fall. The roots are used as the frame for the shelter and are located at the base of a fallen tree. Add additional branches or boughs as a windbreak and dig into the ground to improve the shelter.



Figure 3 Root Shelter

Tawrell, P., Camping and Wilderness Survival, Leonard Paul Tawrell (p. 397)

CONFIRMATION OF TEACHING POINT 2

The cadets' inspection of natural shelters will serve as the confirmation of this TP.

Teaching Point 3

Identify Types of Improvised Shelters

Time: 10 min

Method: Interactive Lecture



Conduct a tour of actual shelters. Examples help illustrate what each shelter looks like and provide cadets with insight into each shelter's purpose.

Have cadets inspect each shelter type.

An improvised shelter is constructed from whatever is available, with little preparation. The type of shelter built will depend on local weather conditions, the materials available and how long the shelter is needed.

BOUGH SHELTER

A bough shelter, also known as a lopped tree shelter, makes use of a naturally fallen tree. With some preparation this shelter provides good cover from the elements. The fallen tree branches are cut from the centre of the tree, creating a hollow for shelter. The excess branches are woven through the remaining tree branches, making the shelter weatherproof.



Figure 4 Bough Shelter

Wiseman, J., The SAS Survival Handbook, HarperCollins Publishers (p. 245)

FALLEN TRUNK

A log or fallen tree trunk makes a useful wind break on its own if it is against the wind. This shelter can be a quickly prepared temporary shelter when time for construction is limited; however, it can be developed into a more permanent shelter with some additional preparation.

If the trunk is small scoop out a hollow in the ground to increase the size of the shelter. The hollow should be opposite the wind (leeward side). A log also makes an excellent support for a lean-to roof of boughs.



Figure 5 Fallen Trunk

Wiseman, J., The SAS Survival Handbook, HarperCollins Publishers (p. 245)

LEAN-TO

The lean-to is one of the most practical and multipurpose shelters. It is easy to assemble and can be built using a support structure of two trees and some poles.

This shelter is constructed by erecting a horizontal crosspiece between trees. On the side facing towards the wind, lean sticks or branches at a 45 degree angle making a roof, and cover the roof with boughs to provide windproofing and waterproofing. If required, add cross ribbing to the roof to provide support for the objects that cover the roof. When using boughs, ensure they are laid upside down to allow rain to run off. Side walls can be added if necessary.



Figure 6 Lean-To

Tawrell, P., Camping and Wilderness Survival, Leonard Paul Tawrell (p. 457)

SNOW CAVE

A snow cave is made from snow drifts and typically provides shelter for a night or two.

To construct a snow cave, dig into a firm large snowdrift, make an entry hole at the low side of the drift and dig up from the entrance to carve out a sleeping shelf.

Block the entry hole with snow and poke ventilation holes in the ceiling to provide plenty of fresh air.



Figure 7 Snow Cave

Berger, K., Backpacking and Hiking, DK Publishing, Inc. (p. 203)

TEPEE

The tepee was developed by nomadic people, it can act as a more permanent shelter.

The tepee is a series of poles sloped in to lean against each other. The sloped poles can be covered with materials to provide a wind break or completely made up of poles. Depending on the materials at hand, they can be constructed quickly.



Figure 8 Tepee

Tawrell, P., Camping and Wilderness Survival, Leonard Paul Tawrell (p. 105)

CONFIRMATION OF TEACHING POINT 3

The cadets' inspection of improvised shelters will serve as the confirmation of this TP.

Teaching Point 4**Locate Natural or Improvised Shelter Sites**

Time: 20 min

Method: Practical Activity

ACTIVITY**OBJECTIVE**

The objective of this activity is to allow the cadets to seek out natural shelters or improvised shelter locations.

RESOURCES

N/A.

ACTIVITY LAYOUT

Provide boundaries for cadets to explore.

ACTIVITY INSTRUCTIONS

- Divide cadets into groups of three or four.
- Have cadets seek out natural shelters and shelter locations.
- Cadets will have 15 minutes to identify a natural shelter or an improvised shelter location.
- Confirm each group has identified an appropriate shelter or shelter location.

SAFETY

The area chosen to conduct this activity will be given boundaries so the cadets will not wander off searching for natural shelters and setting up improvised shelters. A larger area may be used if additional supervision is provided.

END OF LESSON CONFIRMATION

The cadets' participation in the activity in TP4 will serve as the confirmation of this lesson.

CONCLUSION

HOMEWORK/READING/PRACTICE

N/A.

METHOD OF EVALUATION

N/A.

CLOSING STATEMENT

Any cadet who is lost can find a natural shelter or construct a shelter quickly. Remember finding shelter is the second element to survival.

A cadet in a survival situation will now have the knowledge to find a shelter and prolong life while awaiting rescue.

INSTRUCTOR NOTES/REMARKS

N/A.

REFERENCES

C2-004 (ISBN 1-896713-00-9) Tawrell, P. (1996). *Camping and Wilderness Survival: The Ultimate Outdoors Book*. Green Valley, ON: Paul Tawrell.

C2-008 (ISBN 0-00-653140-7) Wiseman, J. (1999). *SAS Survival Handbook*. London: HarperCollins Publishers.

C2-042 (ISBN 0-7566-0946-1) Berger, K. (2005). *Backpacking & Hiking*. New York, NY: DK Publishing, Inc.

THIS PAGE INTENTIONALLY LEFT BLANK



ROYAL CANADIAN ARMY CADETS
RED STAR
INSTRUCTIONAL GUIDE



SECTION 5

EO M224.05 – PREPARE, LIGHT, MAINTAIN, AND EXTINGUISH A FIRE

Total Time:

90 min

PREPARATION

PRE-LESSON INSTRUCTIONS

Resources needed for the delivery of this lesson are listed in the lesson specification located in A-CR-CCP-702/PG-001, Chapter 4. Specific uses for said resources are identified throughout the Instructional Guide within the TP for which they are required.

Review the lesson content and become familiar with the material prior to delivering the lesson.

Prior to this lesson select a site to construct a fire and construct the following fires:

- tepee;
- crossbed; and
- crisscross/pyramid.

Have examples of fuel types as training aids.

PRE-LESSON ASSIGNMENT

N/A.

APPROACH

An interactive lecture was chosen for TP1 and TP2 to introduce fire safety for preparing, lighting, maintaining, and extinguishing a fire.

Demonstration was chosen for TP3 as it allows the instructor to explain and demonstrate preparing, lighting, maintaining and extinguishing a fire.

A practical activity was chosen for TP4 as it is an interactive way to introduce cadets to preparing, lighting, maintaining, and extinguishing a fire, while allowing the cadets to experience this activity in a safe and controlled environment.

INTRODUCTION

REVIEW

N/A.

OBJECTIVES

By the end of this lesson the cadet shall be expected to prepare, light, maintain, and extinguish a fire.

IMPORTANCE

It is important for cadets to prepare, light, maintain and extinguish fires because, as one of the elements of survival, fire provides heat, a means to cook food and can be a signal for rescuers if the cadet becomes lost.

Teaching Point 1

Discuss Fire Safety and the Steps to Follow When Lighting a Fire

Time: 10 min

Method: Interactive Lecture



Discuss how the Fire Weather Index and the Canadian Forest Fire Danger Rating System (CFFDRS) measures the possibility of forest fires.

Some cadets may have already experienced lighting a fire with other organizations.

Pay particular attention to any individuals who may exhibit bad habits when dealing with fire and work to correct their bad habits.

Safety is paramount when lighting a fire. Be sure fire safety equipment is available when lighting fires.

Fire has a strong, positive, psychological impact upon an individual in a survival situation. Fire is the most important survival tool after personal wilderness knowledge and is the fourth element to survival.

Lighting fires in the wilderness requires responsibility. Before planning to light a fire, whether in a survival situation or a weekend bivouac FTX, consideration must be given to the condition of the environment. Check with the appropriate authorities to obtain and review the fire regulations and restrictions for the training area.

FIRE WEATHER INDEX



Before conducting training in provincial or national parks, one must confirm that fires are allowed. Open fires are normally only allowed in designated areas. Open fires are fires that are not contained in a structure or housing that ensures the fire will not spread (e.g. barrel or fireplace).

Each park will clearly state their fire regulations and restrictions.

Parks commonly follow the Fire Weather Index, which provides an assessment of relative fire potential that is based solely on weather observations. Check with park administration for rules and regulations when planning to light fires within the park boundaries.

CANADIAN FOREST FIRE DANGER RATING SYSTEM (CFFDRS)

The CFFDRS is Canada's national system for rating forest fire danger. The system evaluates and integrates data to help managers predict woodland fire potential.

The CFFDRS provides an index (shown below) on how easy it is to ignite vegetation, how difficult a fire may be to control, and how much damage a fire may do.

BLUE	GREEN	YELLOW	ORANGE	RED
LOW	MODERATE	HIGH	VERY HIGH	EXTREME

Figure 1 Fire Index

D Cdts 3, 2007, Ottawa, ON: Department of National Defence

Low. Low chance of fires occurring. Fires that do occur are likely to be self-extinguishing and new ignitions are unlikely.

Moderate. Moderate chance of fires starting. These fires are creeping or gentle surface fires. They are easily contained by ground crews with water pumps.

High. High chance of fire starting. These fires are challenging for ground crews to handle and heavy equipment (tanker trucks and aircraft) are often required to contain the fire.

Very High. Very high chance of a fire starting. These fires are fast spreading and are of high intensity. They are hard to control and require aircraft support.

Extreme. The environment is very dry and chances of fire are extreme. These fires are fast spreading, of high intensity and very difficult to control.



Advise cadets they can review this information for themselves by looking up the CFFDRS on the internet for their area at <https://nofc1.cfsnet.nfis.org/mapserver/cwfis/index.phtml>.

MAINTAINING A SAFE FIRE SITE

Prior to starting a fire, some simple guidelines must be followed. Ensure fire safety equipment is available before starting a fire.

Shovel. A shovel provides a means to smother the fire. Shovelling dirt, gravel or sand on a fire reduces oxygen, thus extinguishing the fire.

Rake. A rake allows one to disperse burning material away from the fire. A rake can also be used to smother the fire by raking dirt, gravel, or sand onto the fire.

Pail Filled With Sand or Water. A pail of water or sand can be immediately thrown over a fire if it starts to get out of control. This item can also be refilled as many times as required.

Fire Extinguisher. A fire extinguisher is designed to tackle a fire for a short duration. It is very effective in extinguishing a small fire that is getting out of control.

CHOOSING A SAFE FIRE LOCATION

Before beginning to build a fire, think about the location. It should be placed for maximum warmth and convenience without sacrificing safety. Consider the following when choosing a safe fire location:

- The fire site should be high and dry.
- The area should be sheltered and away from windy areas to reduce flare ups.
- The site should be clear of over-hanging boughs and branches.
- All combustible materials shall be cleared from the fire site.
- The site should be four to six feet from the shelter entrance.

PREPARING A FIRE BARRIER

A fire ring or pit is a safety barrier that contains a fire within its boundaries and retains heat. By retaining heat one reduces the fire's ability to spread outside the barrier.

Before constructing a fire ring or pit one must determine how big the fire will be. A small fire is much easier to control and also saves fuel. If the fire pit is dug and walled properly, it can produce as much heat as a large one. The fire ring or pit needs to be prepared carefully. Choose a site that meets fire and location considerations.

Fire Ring

A fire ring can be made of rocks. The rocks used should be small in size; however they should still be able to contain a small fire. Place the rocks side by side in a circle to complete the ring. The ring will contain the fire. Water-logged rocks should not be used as the moisture contained inside the rocks will expand and cause the rocks to explode with tremendous force.



Figure 2 Fire Ring

A-CR-CCP-107/PT-001, Royal Canadian Army Cadets Course Training Plan Corps Training Program Winter Adventure Training Manual (p. 3-20)

Fire Pit

A fire can also be placed in a pit if no rocks are present. A pit is a dish-shaped hole with gently sloping sides, from six to twelve inches deep, depending on the width of the fire. This depression cradles the fire, grouping its coals toward the centre to help them burn longer and hotter. Be careful not to make the pit too deep, or the heat may not reach the person making the fire.

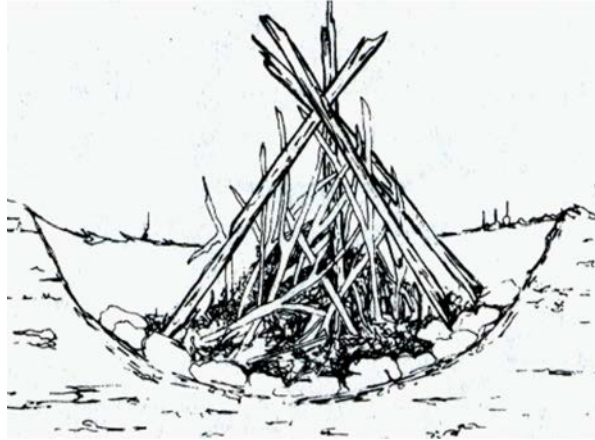


Figure 3 Fire Pit

Brown, T., Jr. and Morgan, B., Tom Brown's Field Guide: Wilderness Survival, The Berkley Publishing Group. (p. 62)

CONFIRMATION OF TEACHING POINT 1

QUESTIONS

- Q1. What do the colours of the CFFDRS indicate?
- Q2. What factors should be considered when choosing a safe fire location?
- Q3. How can a fire barrier be made ?

ANTICIPATED ANSWERS

- A1. The colours of the CFFDRS indicate:
- Blue – Low;
 - Green – Moderate;
 - Yellow – High;
 - Orange – Very High; and
 - Red – Extreme.
- A2. A fire location should be:
- high and dry,
 - in an area that is sheltered away from windy areas to reduce flare ups;
 - clear of over-hanging boughs and branches;
 - away from all combustible materials; and
 - four to six feet from the shelter entrance.
- A3. A fire barrier can be made by building a fire ring or a fire pit.

Teaching Point 2**Identify Characteristics of Fire**

Time: 10 min

Method: Interactive Lecture



Discuss the fire triangle explaining the three elements and the effect the elements have on a fire if one is removed.

Fire may be the difference between living and dying. It will not only heat food for cooking but also keeps a person warm. For a body to produce heat it must burn calories. The warmth of a fire reduces the burden of the body to produce heat.

Fire has a great benefit to a cadet in the field. It can dry clothes, provide comfort and scare away dangerous animals. Its smoke also keeps away insects and pests.

THE FIRE TRIANGLE

Fire is a chemical reaction in which energy in the form of heat is produced. When forest fuels burn there is a chemical combination between the air (oxygen), fuel (wood) and heat that allows a fire to be produced. The sides of the fire triangle represent air, heat, and fuel. If any one of these sides is removed, the fire triangle collapses and the fire goes out.



For fire to take place there must be:

- air (oxygen);
- fuel to burn; and
- heat to start and continue the combustion process.

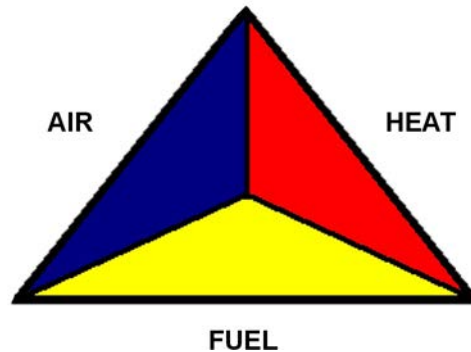


Figure 4 Fire Triangle

D Cdts 3, 2007, Ottawa, ON: Department of National Defence

TYPES OF FUEL

Fire requires fuel to burn. When preparing to light a fire it is important to find enough fuel to supply the fire for a determined period of time. When selecting fuel, there is one key rule – it must be dry.

The driest wood is found high up, away from water sources and on south-facing hillsides with open exposure to the sun. Avoid collecting fire-starting material from the ground, as it may be very damp—especially during wet

weather. Gather dead, dry vegetation from standing trees and plants. Be sure to collect enough fuel to sustain the fire for the duration it is required.

Tinder. Tinder is any kind of material that takes the minimum of heat to light. Good tinder needs only a spark to ignite. Tinder can be:

- bat droppings;
- birch bark;
- cotton fluff;
- dried fungi;
- dried grasses;
- dryer lint;
- fine wood shavings;
- pine needles;
- the insides of a bird's nest; or
- waxed paper.



Material used for tinder must be dry.

It is always a good idea to carry some tinder in a waterproof container when going into the field.

Kindling. Kindling is the next type of fuel required to raise the flames from the tinder so that larger and less combustible materials can be burned. The best kindling is composed of tiny twigs or slivers that range from the thickness of a pencil lead to that of a pencil itself. The softer woods are preferable because they flare up quickly.

In the case of wet weather or if experiencing difficulty establishing a fire, “feather sticks” can be made (see Figure 5). Feather sticks increase the chance of catching the fuel on fire because they are thinner.

Follow these steps to build a feather stick.

- Find a small dry stick.
- Slice partial shavings leaving the shaving attached to the stick.
- Shave using small thin cuts.



Figure 5 Feather Sticks

A-CR-CCP-107/PT-001 (p. 3-20)

Wood Fuel. Wood fuel is thicker and longer than kindling – from pencil to wrist size in diameter. This wood allows a cadet to build a stronger fire that eventually will be able to burn bulk firewood.

Bulk Firewood. Bulk firewood is too-big-to-break fuel that is added to a fire only after the fire is burning well. This wood does not necessarily have to be dry. By the time kindling and wood fuel are burning well, the fire should be hot enough to burn even green and damp wood.

TYPES OF FIRE



Making use of one of the constructed fires, explain to the cadets the type of fuel that is required. Break down the materials displaying tinder, kindling, wood fuel and bulk firewood.

Point out what can be used as tinder. It is especially important to be able to locate dry tinder in a wet environment.

There are many different structural forms for a fire. When building a fire, construct it from the ground up, with room for air to enter. Build it loose with spaces between sticks and wood, allowing it to burn freely.

Tepee Fire. This is one of the most convenient configurations for a fire; it is made with kindling on its end forming a cone. This fire starts easily, burns efficiently, and throws out large quantities of heat and light. Furthermore, most of the smoke and sparks are channelled straight up. The slanting walls and resulting high flames help the fire hold up even in rain and snowstorms.

Follow these steps to build a tepee fire:

1. Line the ground or fire pit with dried bark or grass to prevent moisture from wicking into the fuel.
2. Make a small cone out of the kindling by propping the smallest sticks against one another, tepee fashion.
3. Leave enough room between the twigs for air to get through and leave an opening to apply the tinder inside.
4. Face the opening toward the wind to help drive the flames up through the fuel.
5. As the fire lights, add thicker sticks until the fire can maintain itself for short periods of time.

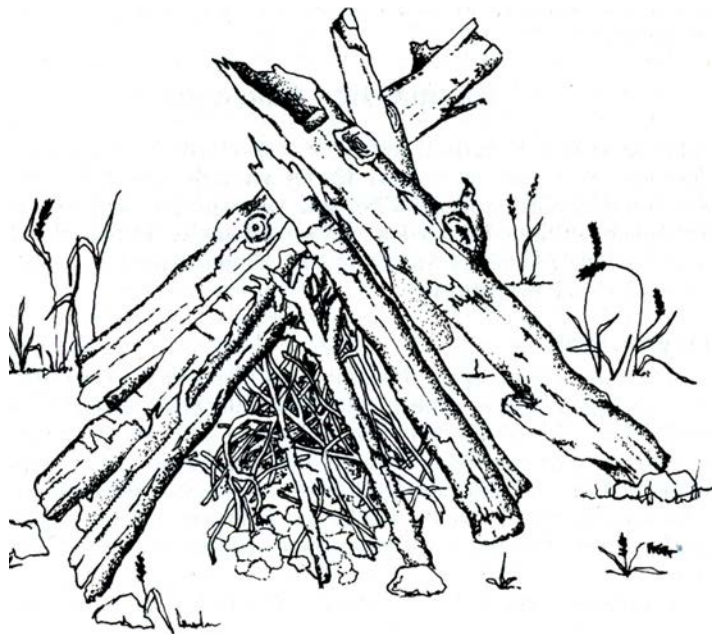


Figure 6 Tepee Fire

Brown, T., Jr. and Morgan, B., Tom Brown's Field Guide: Wilderness Survival, The Berkley Publishing Group (p. 65)

Crossbed Fire. This fire is good if a bed of hot coals for cooking is required. When lit, the whole structure will burn rapidly, leaving a bed of hot coals, excellent for roasting meat or fish.

Follow these steps to build a crossbed fire:

1. Lay two sticks about a foot apart.
2. Place tinder between the two sticks.
3. Place a layer of fuel at right angles to the original two sticks.
4. Leave space between the pieces.
5. Build up several layers in the same fashion, leaving air spaces.
6. Place each layer at right angles to the layer before it.
7. Light the tinder.

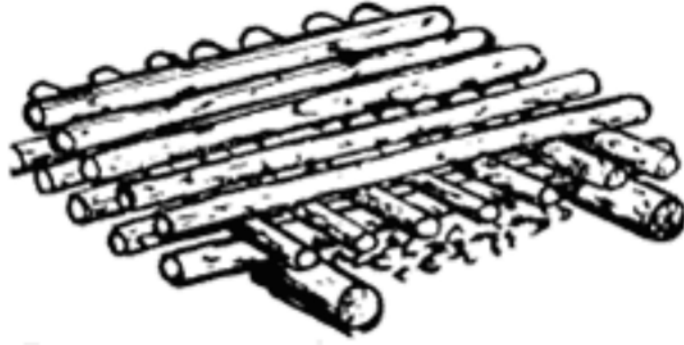


Figure 7 Crossbed Fire

A-CR-CCP-107/PT-001 (p. 3-19)

Crisscross Fire/pyramid. This fire burns from the top downward. It is useful when going to sleep for the night, as it requires little attention and burns slowly.

Follow these steps to build a crisscross/pyramid fire:

1. Place two small logs or branches parallel on the ground.
2. Place a solid layer of small logs across the parallel logs.
3. Add three or four more layers of logs or branches,
4. Each layer shall be smaller and laid at right angles to the layer below it.
5. Make a starter fire on top of the crisscross/pyramid fire.
6. As the fire burns it will ignite the logs below it.

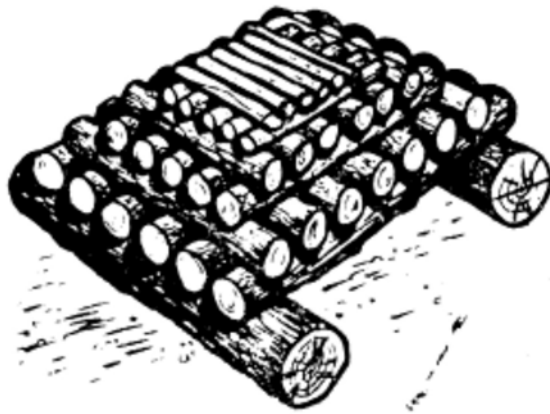


Figure 8 Crisscross/Pyramid Fire

A-CR-CCP-107/PT-001 (p. 3-20)

CONFIRMATION OF TEACHING POINT 2

QUESTIONS

- Q1. What elements make up the fire triangle?
- Q2. If air is removed from the fire triangle, what happens to the fire?
- Q3. Name three types of fire.

ANTICIPATED ANSWERS

- A1. The elements that make up the fire triangle are air, fuel and heat.
- A2. The fire will go out.
- A3. Three types of fires are the tepee, crossbed and crisscross/pyramid.

Teaching Point 3

Demonstrate Preparing, Lighting, Maintaining and Extinguishing a Fire

Time: 10 min

Method: Demonstration



Conduct this TP as a demonstration of lighting a fire. Go through the steps of preparing, lighting, maintaining and extinguishing a fire.

PREPARING A FIRE

To prepare a fire, build it step by step. Start by laying out fuel in organized piles of kindling, tinder and larger burnable fuels by:

1. **Preparing Tinder.** Place a small handful of tinder in the selected location.
2. **Preparing Kindling.** Place kindling in a style that suits the type of fire that is being constructed (e.g. tepee style).
3. **Preparing Fuel.** Have wood fuel prepared to apply to the fire once it is established. Adding larger fuel may smother the fire if the fire is not ready to burn larger fuel.
4. **Ensuring Ventilation.** Allow for air to reach the kindling and tinder. Do not apply too much fuel at once as the fire may be starved of air prior to ignition. Air should naturally be able to flow, without additional assistance, to encourage growth of the fire.

LIGHTING A FIRE

To light a fire using a match, light the kindling and monitor the fire. Apply more kindling as required to maintain a burning fire.

MAINTAINING A FIRE

Maintaining a fire requires a constant source of fuel. Fuel that maintains a fire is usually of larger material considered to be bulk firewood. This fuel will not be consumed by the fire very quickly. It will continue to burn for long periods of time.

When maintaining a fire:

1. **Apply Fuel.** Once the fire has a strong base of hot coals, (coals are red hot) apply bulk fire wood.



Figure 9 Fire With Developed Coals

Tawrell, P., Camping and Wilderness Survival, Leonard Paul Tawrell (p. 433)

2. **Ensure Ventilation.** Applying bulk firewood may smother the fire. Place bulk firewood so air is able to circulate. Bulk firewood can be placed in any of the fire types (tepee, crossbed, or crisscross/pyramid) by laying the log with one end into the centre of the fire and the other end extending out to the edge of the fire. Continue this process around the fire. Leave spaces between the bulk firewood for air to circulate.

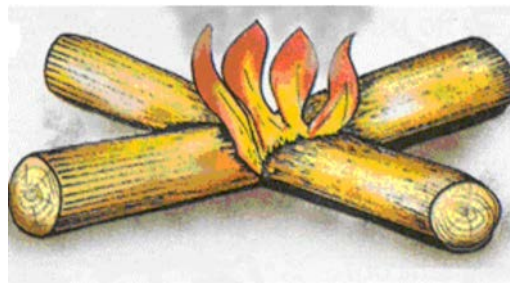


Figure 10 Star Fire

Tawrell, P., Camping and Wilderness Survival, Leonard Paul Tawrell (p. 433)

3. **Maintain Fire Size.** Fires can easily be over fuelled. To maintain the correct size, limit the amount of fuel used until desired size and warmth is achieved. If the fire is for cooking, hot coals and less fuel is sufficient.

EXTINGUISH A FIRE

As the fire burns, plan ahead to extinguish it. Stop feeding the fire long before (time enough to let the remaining fuel burn off) it must be extinguished. Collect and pile the remaining chunks of burning wood so they are consumed by the flames, leaving only ashes and coals to dispose of when the fire has finished burning.

Once the fire has burned itself down to white ash, douse it thoroughly with water. Pour water over the ashes, stirring them occasionally to ensure the coals are completely extinguished. Replace or fill the fire pit with wet earth or sand to ensure no flare ups will occur.

If this is a new campfire site, scatter the ashes and replace the sod or decomposing material from the forest floor, returning the site to its original condition.

CONFIRMATION OF TEACHING POINT 3**QUESTIONS**

- Q1. What are the two types of fuel used to start a fire?
- Q2. If it is hard to start a fire or the fuel is wet, what can you do to a stick to increase the chances of it catching fire?
- Q3. How do you extinguish a fire?

ANTICIPATED ANSWERS

- A1. Tinder and kindling.
- A2. You can make a feather stick.
- A3. Once the fire has burned itself down to white ash, douse it thoroughly with water. Pour water over the ashes, stirring them occasionally to ensure that they are completely extinguished. Replace or fill the fire pit with wet earth or sand to ensure no flare ups occur.

Teaching Point 4**Prepare, Light, Maintain and Extinguish a Fire**

Time: 50 min

Method: Practical Activity

ACTIVITY**OBJECTIVE**

The objective of this activity is to allow cadets to practice preparing, lighting, maintaining and extinguishing a fire.

RESOURCES

Matches.

ACTIVITY LAYOUT

N/A.

ACTIVITY INSTRUCTIONS

1. Divide cadets into groups of four.
2. Assign each group a type of fire to construct.
3. Fires shall be constructed and lit within 20 minutes.
4. Each fire must be maintained for 10 minutes.
5. All fires must be extinguished, ensuring no smouldering coals are present.
6. Ensure fire sites are cleaned up and returned to their original state within 20 minutes.

SAFETY

Supervisory staff shall have fire safety equipment available in case of an emergency.

CONFIRMATION OF TEACHING POINT 4

The cadets' participation in the activity in TP4 will serve as the confirmation of this TP.

END OF LESSON CONFIRMATION

The cadets' participation in the activity in TP4 will serve as the confirmation of this lesson.

CONCLUSION

HOMEWORK/READING/PRACTICE

N/A.

METHOD OF EVALUATION

N/A.

CLOSING STATEMENT

Cadets, having learned to prepare, light, maintain and extinguish a fire can now construct the type of fire to meet their needs. Emergency situations present constantly changing conditions. The ability to construct a specific fire is essential to increasing the chances of survival.

INSTRUCTOR NOTES/REMARKS

N/A.

REFERENCES

A2-040 A-CR-CCP-107/PT-001 Department of National Defence. (1978). *Royal Canadian Army Cadets Course Training Plan Adventure Training*. Ottawa, ON: Department of National Defence.

C0-111 (ISBN 978-0-9740820-2-8) Tawrell, P. (2006). *Camping and Wilderness Survival: The Ultimate Outdoors Book* (2nd ed.). Lebanon, NH: Leonard Paul Tawrell.

C2-004 (ISBN 1-896713-00-9) Tawrell, P. (1996). *Camping and Wilderness Survival: The Ultimate Outdoors Book*. Green Valley, ON: Paul Tawrell.

C2-042 (ISBN 0-7566-0946-1) Berger, K. (2005). *Backpacking & Hiking*. New York, NY: DK Publishing, Inc.

C2-068 (ISBN 0-425-10572-5) Brown, T., Jr. with Morgan, B. (1983). *Tom Brown's Field Guide To: Wilderness Survival*. New York, NY: The Berkley Publishing Group.



ROYAL CANADIAN ARMY CADETS

RED STAR

INSTRUCTIONAL GUIDE



SECTION 6

EO M224.06 – IDENTIFY METHODS OF SIGNALLING

Total Time: 60 min

PREPARATION

PRE-LESSON INSTRUCTIONS

Resources needed for the delivery of this lesson are listed in the lesson specification located in A-CR-CCP-702/PG-001, Chapter 4 of. Specific uses for said resources are identified throughout the Instructional Guide within the TP for which they are required.

Review the lesson content and become familiar with the material prior to delivering the lesson.

Prepare a ground-to-air message signal for cadets to see as a visual aid.

Permission will be obtained for a signal fire from the local authorities (e.g. local police, forestry service, and/or airport authority). The following information will be provided:

1. the organization;
2. a contact name;
3. a contact number;
4. the location including grid reference (GR);
5. the estimated time of lighting; and
6. the duration the fire is expected to be lit.

PRE-LESSON ASSIGNMENT

N/A.

APPROACH

An interactive lecture was chosen for TP1 and TP2 to introduce and allow the cadets an opportunity to practice signalling methods.

A practical activity was chosen for TP3 as it is an interactive way to introduce cadets to methods of signalling. This activity contributes to the development of survival skills in a fun and challenging setting.

INTRODUCTION

REVIEW

N/A.

OBJECTIVES

By the end of this lesson the cadet shall be expected to identify methods of signalling.

IMPORTANCE

It is important for cadets to know how to signal for help so they can increase their chances of being located more quickly, if they become lost.

Teaching Point 1

Discuss Signalling Devices

Time: 10 min

Method: Interactive Lecture



This TP focuses on signalling devices that can be used in the field. Ask the cadets if they know of anyone who was lost and was found through the use of a signalling device.

Discuss the way in which the individual signalled for help. Point out any key reasons why the individual was found because of the signal.

If there is no story provided by the cadets, a story has been provided below. Read the story and have the cadets brainstorm for a moment and ask them what they think Dave can use to signal for help.

Keep in mind the cadets have no idea what materials Dave has or what he brought with him. Assume he has everything and get the cadets to think about what can be used to signal search and rescuers.

Continue with the TP, describing the signals and how they can be employed.

Survival Story

It is a beautiful summer day and Dave decides to go for a hike. Before leaving his house he writes a note to his wife saying where he is going and that he expects to be back by suppertime (1700hrs).

Leaving his home and arriving at the base of his normal hiking trails he decides to take a new route that he has never travelled before. The hiking trails in this area are usually safe and easy. The trails are always marked and the route is easy to follow. As the day wears on, Dave finds he is running a little behind on his timings and decides to speed up his pace.

Cutting across some rough, rocky ground, Dave suddenly loses his footing, jams his foot between two rocks and falls over. Hearing a loud snap and feeling a sudden rush of pain spreading up from his ankle, Dave realizes he has broken his ankle.

After freeing himself and splinting his ankle, Dave knows he will not be able to walk out of the woods. Preparing for a night in the woods, Dave applies the S.T.O.P. principles and thinks about the five elements of survival. Dave finds a natural, tree hollow shelter suitable for a night's stay in the field. Dave knows his wife will send for help. However, he is not on his normal hiking routes.

Determining that he may have to signal for help, he begins to think about what options he has.

SIGNALLING

Signalling for help is essential for increasing the chances of being located quickly. Establishing contact with, or attracting the attention of search and rescuers should be the main objective after all vital survival needs have been addressed.

When preparing signals keep the following points in mind.

- Be sure to have signals ready and place them in open areas that are readily seen from the ground and the air.
- Prepare as many types of signals as possible.
- Protect signals and equipment from moisture and cold.
- Any unusual sign or colour contrast is visible from the air, even a trail in the snow.
- Care for all signalling equipment to prolong its use.

SIGNALLING DEVICES

Flares. Flares are small rockets that ascend to a high altitude of approximately 45-60 metres and burn for approximately 7-15 seconds. The flare emits a single Red Star. This bright light can be seen for many miles depending on the weather. When choosing a signal flare, be sure to try to deploy it from an elevated position where no obstructions exist overhead.

Mirrors. Mirrors can reflect sunlight beyond the horizon up to seven million candlepower. Hold the mirror in your hand with your arm outstretched. Sight along your arm to aim the mirror, flash at particular points along the horizon. Send three flashes.

Whistles. Whistles emit a loud piercing sound. They are designed to be heard above ambient noise, the roar of engines, breaking waves and gale force winds. Blowing a whistle three times in succession, signals anyone who hears this that someone requires help.



A series of three signals (whistles, flashes, etc.) in a row represents the universal distress call. It is similar to the S.O.S. morse code signal.

Radios and Cell Phones. These items can provide a direct link to help immediately. Location may hinder or completely restrict a signal. Move to higher ground that is close by and attempt an emergency call again. Communications dealing with distress, urgency, or safety have priority over other radio traffic. Identify who is calling, speak clearly and keep communications as brief as possible. Arrange a check in time and turn off the phone to save battery life in emergency situations.

Fire and Smoke. Fire and smoke can be used to attract the attention of search and rescuers. Three evenly spaced fires, 35 metres or 100 feet apart, arranged in a triangle or in a straight line, serve as an international distress signal. One signal fire will usually work. During the night, the flames should be as bright as possible and during the day, the fire should produce as much smoke as possible.

CONFIRMATION OF TEACHING POINT 1

QUESTIONS

- Q1. What are three points you should keep in mind when preparing signals?
- Q2. Name five signalling devices.
- Q3. If you found yourself lost in the woods what could produce a very loud piercing sound to signal that you are in trouble?

ANTICIPATED ANSWERS

A1. Any of the following:

- Be sure to have signals ready and place them in open areas that are readily seen from the ground and the air.
- Prepare as many types of signals as possible.
- Protect signals and equipment from moisture and cold.
- Any unusual sign or colour contrast is visible from the air, even a trail in the snow.
- Care for all signalling equipment to prolong its use.

A2. Five signalling devices are:

- Flares.
- Mirrors.
- Whistles.
- Radios and cell phones.
- Fire and smoke.

A3. A whistle could produce a very loud piercing sound.

Teaching Point 2

Discuss Ground-to-air Signals Employed to Communicate With Aircraft

Time: 15 min

Method: Interactive Lecture



Start this lesson by showing the cadets the previously prepared ground-to-air signal. While instructing this TP, refer to aspects of the prepared signal as a visual aid.

Orient the signal to take advantage of the sun and the casting of a shadow. Making use of shadows will greatly enhance the signal. Reinforce the importance of having a correctly oriented and developed signal.

Typically, when a person becomes lost a search will commence around the last known position. These parameters will expand when nothing is found along the intended route. Searchers will be looking for anything out of the ordinary and their eyes will be drawn to unnatural features of the ground. Make the site as conspicuous as possible by preparing ground-to-air signals.

SIGNAL DIMENSIONS

A signal should be as large as possible. To be the most effective, the signal should have lines no less than 1 m wide (3 feet) and 8 m long (26 feet). Care should be taken to ensure symbols are laid out exactly as depicted. From the air, symbols will appear close together as altitude increases. Ensure each symbol is at least 3 m apart (10 feet).

CONTRASTING SHADES OR COLOURS



Illustrating and defining a shadow created from a ground-to-air signal may be difficult.

Ensure that the signal is parallel to the sun's direction of travel (e.g. east to west) and be sure to make the signal large enough to produce a shadow.

A signal should stand out sharply against its background. This helps to make the signal appear larger. Everything must be done to disturb the natural look of the ground. This can be accomplished by:

- stamping down grass or turning it over to allow the signal to be easily seen from the air;
- burning a pattern in the grass;
- trampling out a signal in the snow, using only one path to and from the signal; and
- considering the shadow created by the sun and maximizing the shadow created by stamped foot markings or snow piles.



The signal should be located so it can be seen from all directions. Make sure the signal is located away from shadows and overhangs. A large, high, open area is preferable.

GROUND-TO-AIR SIGNALS

The following symbols are to be used to communicate with aircraft when an emergency exists. Symbols 1 to 5 are internationally accepted; 6 to 9 are for use in Canada only.

NO.	MESSAGE	CORE SYMBOL
1.	Require Assistance	V
2.	Require Medical Assistance	X
3.	No or Negative	N
4.	Yes or Affirmative	Y
5.	Proceeding In This Direction	↑
6.	All Is Well	LL
7.	Require Food and Water	F
8.	Require Fuel and Oil	L
9.	Need Repairs	W

Figure 1 Ground-to-Air Signals

D Cdts 3, 2007, Ottawa, ON: Department of National Defence

CONFIRMATION OF TEACHING POINT 2

QUESTIONS

- Q1. What should the dimensions of a ground-to-air signal be?
- Q2. If you were asked to make the symbol V on the ground, what would it mean to an aircraft above?
- Q3. How does one create a contrasting shade on the ground?

ANTICIPATED ANSWERS

A1. A ground-to-air signal should be 1 m wide by 8 m long.

A2. The symbol V means someone requires assistance.

A3. To create a contrasting shade on the ground:

- stamp down grass or turn it over to allow the signal to be easily seen from the air;
- burn a pattern in the grass;
- tramp out a signal in the snow, using only one path to and from the signal; and
- consider the shadow created by the sun and maximize the shadow created by stamped foot markings or snow piles.

Teaching Point 3

Construct a Ground-to-air Signal

Time: 25 min

Method: Practical Activity

ACTIVITY

OBJECTIVE

The objective of this activity is to construct a ground-to-air signal capable of being seen from aircraft.

RESOURCES

Objects and debris from the surrounding environment.

ACTIVITY LAYOUT

N/A.

ACTIVITY INSTRUCTIONS

- Divide the cadets into groups of no more than four.
- Assign the groups one of the five ground-to-air signals to construct.
- Give the cadets 20 minutes to seek out materials and create their signal.
- Upon completion, inspect the signals and confirm they meet the dimensions.
- Disassemble all signals and return materials to original locations.

SAFETY

Establish boundaries for the cadets who are gathering materials.

CONFIRMATION OF TEACHING POINT 3

The cadets' participation in this activity will serve as the confirmation of this TP.

END OF LESSON CONFIRMATION

The cadets' participation in the activity in TP3 will serve as the confirmation of this lesson.

CONCLUSION

HOMework/READING/PRACTICE

N/A.

METHOD OF EVALUATION

N/A.

CLOSING STATEMENT

Signals provide a cadet in distress with the means to gain the attention of search and rescuers. Cadets who become lost can employ the actions to take when lost through completing the S.T.O.P. acronym and include in their plans a method of signalling for help.

INSTRUCTOR NOTES/REMARKS

N/A.

REFERENCES

C2-016 (ISBN 0-517-88783-5) Curtis, R. (1998). *The Backpacker's Field Manual: A Comprehensive Guide to Mastering Backcountry Skills*. New York, NY: Three Rivers Press.

C2-044 Department of Transportation. (2007). *Ground-to-Air Signals*. Retrieved 9 February 2007, from <http://www.tc.gc.ca/CivilAviation/publications/tp14371/SAS/4-0.htm>.

THIS PAGE INTENTIONALLY LEFT BLANK



ROYAL CANADIAN ARMY CADETS
RED STAR
INSTRUCTIONAL GUIDE



SECTION 7

EO C224.01 – COOK IN THE FIELD

Total Time: 60 min

PREPARATION

PRE-LESSON INSTRUCTIONS

Resources needed for the delivery of this lesson are listed in the lesson specification located in A-CR-CCP-702/PG-001, Chapter 4. Specific uses for said resources are identified throughout the Instructional Guide within the TP for which they are required.

Review the lesson content and become familiar with the material prior to delivering the lesson.

From EO M224.05 (Prepare, Light, Maintain, and Extinguish a Fire), review:

- choosing a safe fire site;
- preparing a fire;
- lighting a fire;
- maintaining a fire; and
- extinguishing a fire.

PRE-LESSON ASSIGNMENT

N/A.

APPROACH

An interactive lecture was chosen for TP1 to introduce cooking in the field and to present basic or background material.

A practical activity was chosen for TP2 as it is an interactive way to introduce cadets to cooking in the field. This activity contributes to the development of survival skills in a fun and challenging setting.

INTRODUCTION

REVIEW

The review for this lesson is from EO M224.05 (Prepare, Light, Maintain, and Extinguish a Fire).

QUESTIONS

- Q1. What does a fire need in order to burn?
- Q2. How is a fire lit?
- Q3. How can a fire be extinguished?

ANTICIPATED ANSWERS

- A1. In order to burn, a fire needs air (oxygen), fuel and heat.
- A2. To light a fire using a match, light the kindling and monitor it.
- A3. To extinguish a fire one can stop feeding it, cover it with wet earth or douse it thoroughly with water.

OBJECTIVES

By the end of this lesson the cadet shall be expected to cook in the field.

IMPORTANCE

It is important for cadets to know different ways to cook and prepare meals in the field. In a survival situation, it is extremely important to be familiar with different cooking options. Having the confidence to use these methods to cook food will help a cadet get nutrition and energy when they are needed.

Teaching Point 1

Discuss Methods for Cooking in the Field

Time: 15 min

Method: Interactive Lecture



All of the methods listed require prior preparation of the food being cooked. This involves peeling/skinning, cleaning and wrapping. When cooking in the field, food must be properly prepared. Cadets will prepare a potato for baking in TP2. Preparing other foods (e.g. meat, such as rabbits) will be discussed in Silver Star.

Cooking in the field is an important skill for people who find themselves in a survival situation. Since the human body needs nutrients and energy, cooking is essential. There are many different ways to cook in the field.

BAKING IN A SHALLOW PIT LINED WITH ROCKS

The best way to bake in the field is in the ground. When food is buried, it will cook faster. To do this:

1. Dig a shallow pit in the ground.
2. Line the pit with rocks.
3. Burn a small fire to get a bed of coals.
4. Place a layer of wet grass on the embers when there are no more open flames and only hot, red embers remaining (if the grass is dry, soak in water).
5. Place the food (already prepared to be cooked) on top of the wet grass.
6. Use a stick to move around the hot coals to get them as close to the food as possible. Try to put some coals on top of the food.
7. Cover the food with the earth that was dug from the pit.

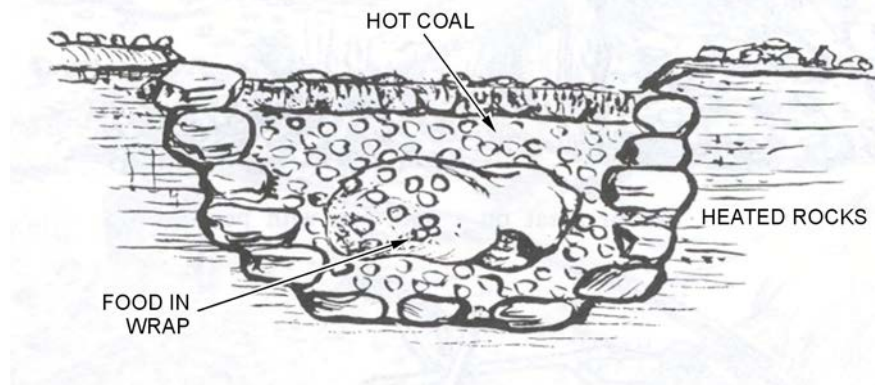


Figure 1 Baking in the Ground

B-GA-217-001/PT-001, Down But Not Out (p.130)



When using this method, it is very difficult to check and see if the food is cooked. Cooking time will vary, depending on what is being cooked. Ensure food is completely cooked before consuming. Place it back in the ground and allow more time if unsure.

ROASTING WITH A STICK

Roasting is an easy method that produces tasty results. Unfortunately, it also produces a lot of grease when cooking meat. To minimize waste, place a pot or container under the roasting food to catch grease. Place the object being cooked on the end of a stick, beside an open fire. The food should not be placed directly over the fire and direct contact with smoke and flame should be avoided as much as possible.

The food will need to be rotated or turned to ensure it is cooked throughout. If dangling the object, a rotor, made with plastic or heavy paper, can be attached (see Figure 3). The rotor will catch and turn in the wind, turning the food.

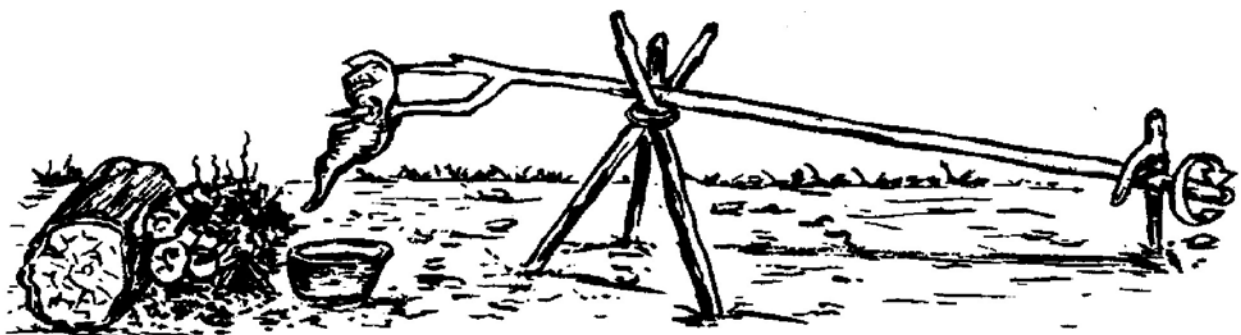


Figure 2 Roasting

B-GA-217-001/PT-001 (p.129)

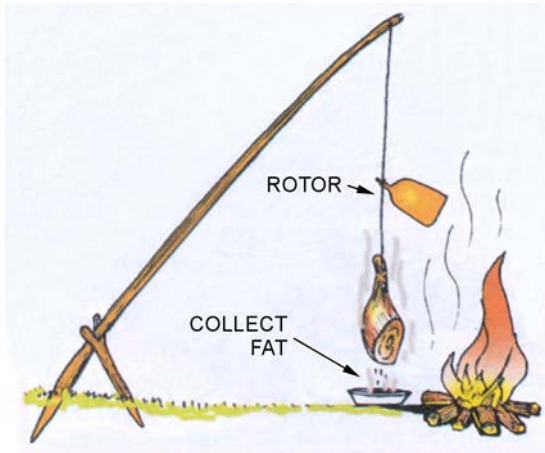


Figure 3 Roasting With a Rotor

Tawrell, P., Camping and Wilderness Survival, Leonard Paul Tawrell (p. 442)





Figure 4 Roasting Fish

Tawrell, P., Camping and Wilderness Survival, Leonard Paul Tawrell (p. 448)

BOILING IN A POT

Boiling in a pot can be done over an open fire, the same as on a stove. When boiling in a pot, ensure the pot is sitting straight up on the fire. This can be done by using a grill, wedging it between two pieces of thick wood or placing rocks around to stabilize it. There are many ways to place a pot over a fire using wood (see Figures 5 to 8). It is important to ensure the pot is stable and does not have a risk of falling into the fire.

 Seeing bubbles is an easy way to tell that water is boiling.

 Boiling over an open fire will normally cause soot to form on the outside of the pot. A coating of soapy water on the outside of the pot will make cleaning much easier.

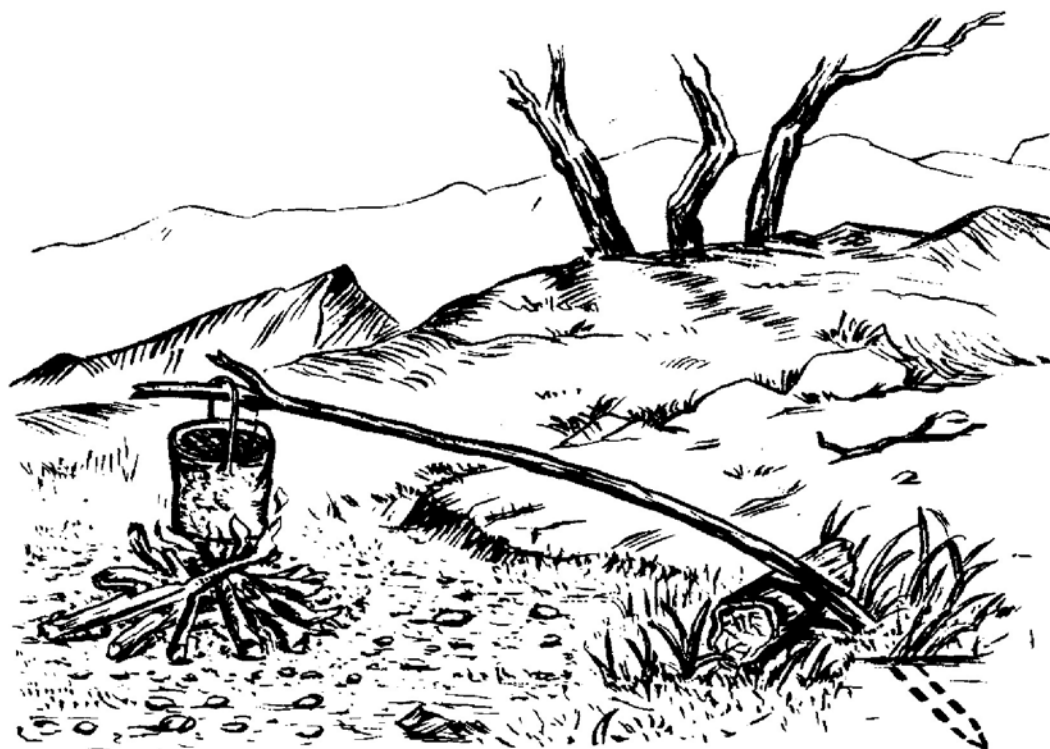


Figure 5 Boiling

B-GA-217-000/PT-001 (p.128)

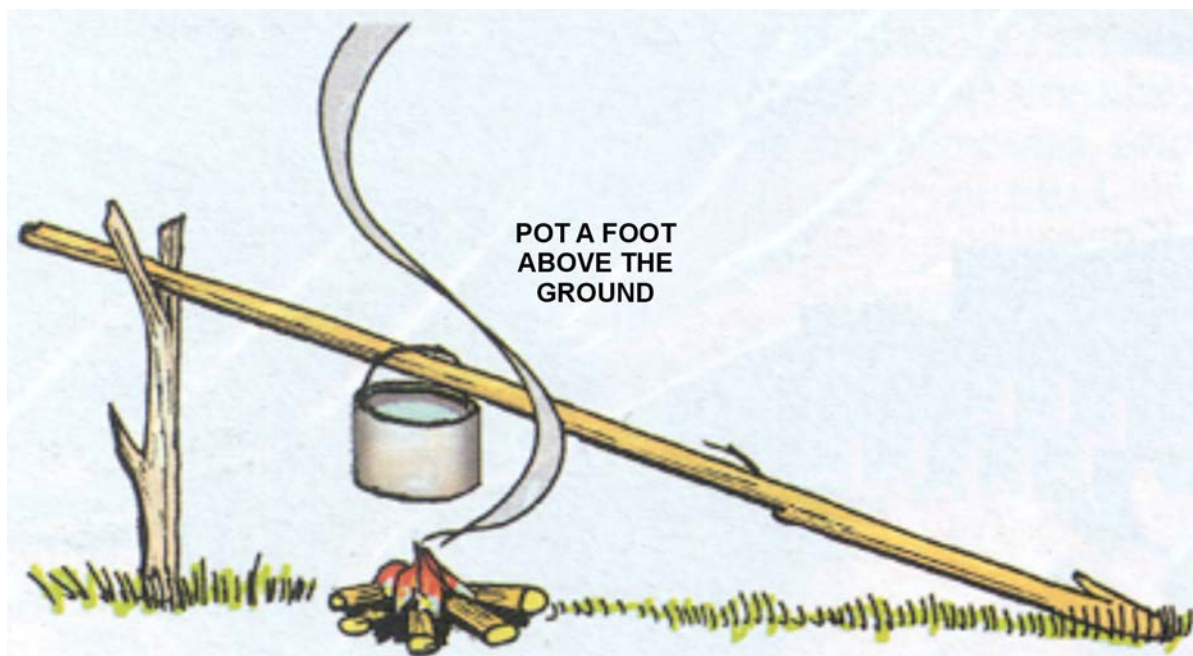


Figure 6 Boiling

Tawrell, P., Camping and Wilderness Survival, Leonard Paul Tawrell (p. 442)

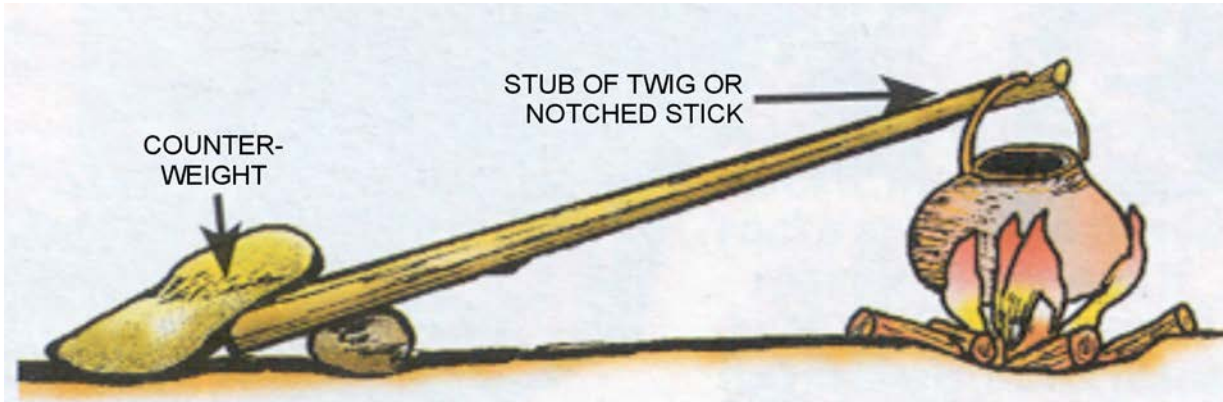


Figure 7 Boiling Using a Counterweight

Tawrell, P., Camping and Wilderness Survival, Leonard Paul Tawrell (p. 442)

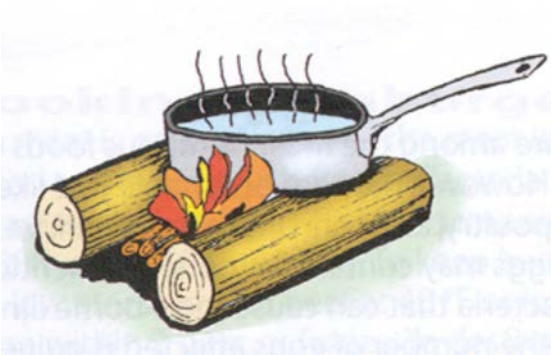


Figure 8 Boiling on an Open Flame With Wood

Tawrell, P., Camping and Wilderness Survival, Leonard Paul Tawrell (p. 444)

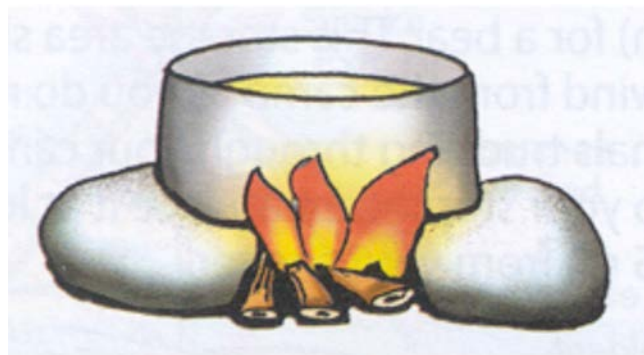


Figure 9 Boiling on an Open Flame With Rocks

Tawrell, P., Camping and Wilderness Survival, Leonard Paul Tawrell (p. 442)

FRYING

Food can be easily fried on a rock or sheet of metal. A rock will hold a lot of heat for a very long time. When using this method to cook, food may easily stick if there is not a sufficient amount of grease.

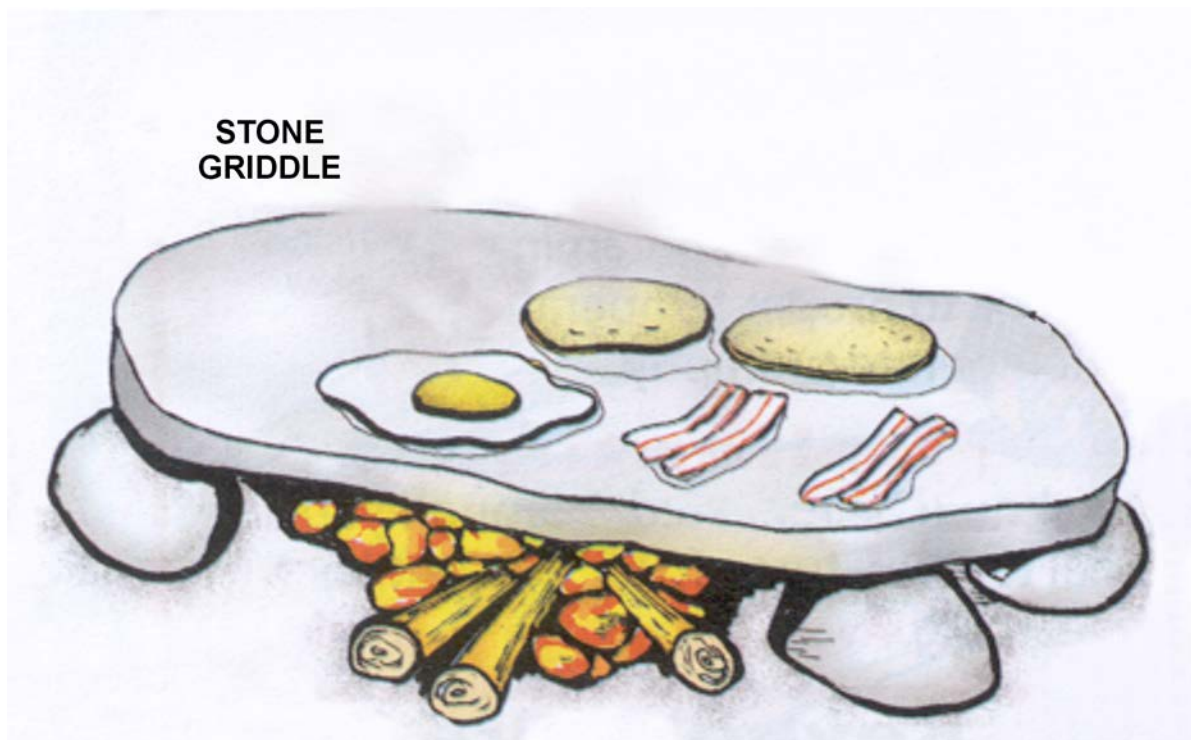


Figure 10 Frying on a Flat Rock

Tawrell, P., *Camping and Wilderness Survival*, Leonard Paul Tawrell (p. 442)

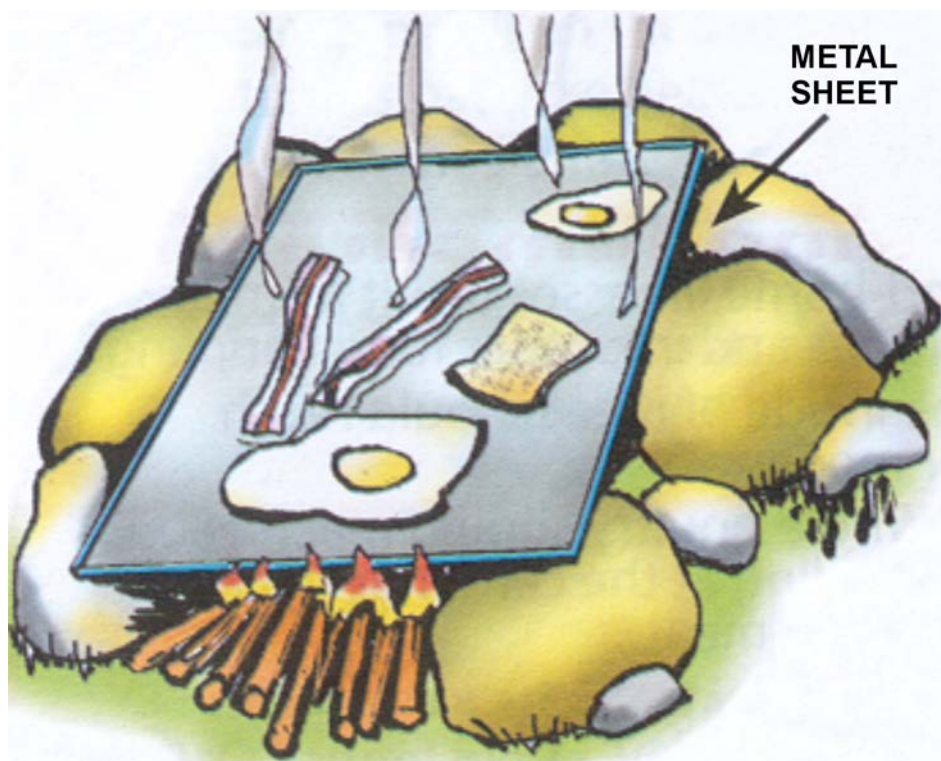


Figure 11 Frying With a Metal Sheet

Tawrell, P., *Camping and Wilderness Survival*, Leonard Paul Tawrell (p. 442)

CONFIRMATION OF TEACHING POINT 1

QUESTIONS

- Q1. What are some methods for cooking in the field?
- Q2. Why is it important to make sure that a pot is stable when boiling?
- Q3. What is a disadvantage of frying?

ANTICIPATED ANSWERS

- A1. Some methods for cooking in the field are baking, roasting, boiling and frying.
- A2. It is important that the pot is stable so that it does not fall into the fire.
- A3. A disadvantage of frying is that food will probably stick to the cooking surface if there is not enough grease.

Teaching Point 2

Prepare and Bake a Potato in the Ground

Time: 35 min

Method: Practical Activity



Any food being cooked must be prepared first. Cadets will prepare a potato for baking in the ground.

Ensure that fires are small, since they must be extinguished before baking occurs.

Once the potatoes are placed in the ground, they will take approximately 30 minutes to cook. The cadets will have to come back after this lesson to retrieve their potato.

All fire pits should be marked to ensure no pit is forgotten.

ACTIVITY

OBJECTIVE

The objective of this activity is to prepare and bake a potato in the ground.

RESOURCES

- Water;
- Potato;
- Tin foil;
- Matches; and
- Shovels.

ACTIVITY LAYOUT

This activity must take place in a large open area, with enough room for each group of cadets to cook a potato in the ground.

ACTIVITY INSTRUCTIONS

1. To prepare the potatoes:
 - a. Distribute one potato to each cadet.
 - b. Have each cadet wash and scrub their potato with water.
 - c. Have each cadet wrap their potato in tin foil. All potatoes should be completely wrapped at least three times in the tin foil.
2. Divide the cadets into groups of two to four.
3. Have each group dig a shallow pit in the ground.
4. Line the pit with rocks.
5. Burn a small tepee or crossbed fire to get a bed of coals.
6. Place a layer of wet grass on the embers when there are no more open flames and only hot, red embers remaining (if the grass is dry, use water).
7. Place the wrapped potatoes on top of the wet grass.
8. Use a stick to move around the hot coals to get them as close to the potato as possible, trying to put some coals on top of the potato.
9. Cover the potato with the earth that was dug from the pit.



Some cadets may wish to peel their potato prior to preparing it. A small pocket knife can do this.

If shovels are limited, encourage the cadets to find creative ways to dig the hole (e.g. with hollowed wood or with a spoon).

Cadets may wish to have salt, butter, sour cream, etc. with their potato.

Potatoes will take approximately 30 minutes to cook. Enjoy!

SAFETY

- Supervisory staff shall have fire safety equipment available in case of emergency.
- Potatoes will be hot, use extreme caution.

CONFIRMATION OF TEACHING POINT 2

The cadets' participation in the activity will serve as the confirmation of this TP.

END OF LESSON CONFIRMATION

The cadets' participation in baking a potato in the ground will serve as the confirmation of this lesson.

CONCLUSION

HOMEWORK/READING/PRACTICE

N/A.

METHOD OF EVALUATION

N/A.

CLOSING STATEMENT

Knowing how to cook in the field is a great skill to have when lost. Knowing the many different ways to cook in the field could mean the difference in a person making it through a survival situation. Being able to use different methods of cooking in the field is also a fun way to cook food when on a weekend bivouac FTX.

INSTRUCTOR NOTES/REMARKS

The construction of fire pits requires additional supervision and the availability of fire safety equipment. Fire pits are to be marked with flags and must be supervised while baking is in progress.

REFERENCES

A2-046 B-GA-217-001/PT-001 *Down But Not Out*. (ND). Ottawa, ON: Department of National Defence.

C0-111 (ISBN 0-9740820-2-3) Tawrell, P. (2006). *Camping and Wilderness Survival: The Ultimate Outdoors Book* (2nd ed.). Lebanon, NH: Leonard Paul Tawrell.



ROYAL CANADIAN ARMY CADETS

RED STAR

INSTRUCTIONAL GUIDE



SECTION 8

EO C224.02 – PREPARE A SIGNAL FIRE

Total Time:

60 min

PREPARATION

PRE-LESSON INSTRUCTIONS

Resources needed for the delivery of this lesson are listed in the lesson specification located in A-CR-CCP-702/PG-001, Chapter 4. Specific uses for said resources are identified throughout the Instructional Guide within the TP for which they are required.

Review the lesson content and become familiar with the material prior to delivering the lesson.

Prior to conducting this lesson, prepare the following:

- a three fire triangle;
- a torch tree; and
- a luminous cone fire.

Instructors will only demonstrate lighting the first of the prepared signal fires.

Additional supervision is required during the lighting of the signal fires. Fire safety equipment shall also be present.

The fire index is to be checked and appropriate authorities (e.g. local police, forestry service, and/or airport authority) shall be notified of the lighting of the signal fires. Authorities will be provided with the following information:

- corps contact name;
- contact number;
- location including grid reference;
- estimated time of lighting; and
- the duration the fire is expected to be lit.



Some localities may require the issue of special permission to conduct open/signal fires. Be sure permission is granted by the appropriate authorities listed above.

PRE-LESSON ASSIGNMENT

N/A.

APPROACH

An interactive lecture was chosen for TP1 and TP2 to introduce the types of signal fires and to identify locations to prepare signal fires.

Demonstration was chosen for TP3 as it allows the instructor to explain or demonstrate preparing a signal fire.

A practical activity was chosen for TP4 as it is an interactive way to allow cadets to prepare a signal fire and witness the lighting of the signal fire in a safe and controlled environment.

INTRODUCTION

REVIEW

The review for this lesson will be from EO M224.05 (Prepare, Light, Maintain, and Extinguish a Fire), to include:

Selecting and Preparing Tinder. Tinder is any kind of material that a minimum amount of heat will ignite. Good tinder is dry and needs only a spark to set it ablaze. Birch bark, dry grass, fine wood shavings, bird down, waxed paper and cotton fluff from clothing all make good tinder. It is a good idea to carry tinder in a waterproof container.

Selecting and Preparing Kindling. Kindling is the wood used to raise flames from the tinder so larger, less combustible materials can be burned. The best kindling consists of small, dry twigs and small pieces of softwood. Kindling should not be collected straight from the earth because it is usually damp. It should be gathered from standing deadwood.

Selecting and Preparing Fuel. Fuel is anything that will burn in the fire. Dry wood from standing trees should be used to get fires going. Once the fire is established, greener and damp wood may be used. Hardwoods including hickory, beech, maple and oak burn well, give off heat and last as long as hot coals. The fire can be maintained for a long period of time using hardwoods.

Softwoods burn very quickly and give off sparks and can be used when lighting the fire. Softwoods include cedar, alder, hemlock, spruce, pine, chestnut and willow. After the fire is burning steadily, fuel that is three to four times the size of the kindling can be added.

OBJECTIVES

By the end of this lesson the cadets shall be expected to prepare and light a signal fire.

IMPORTANCE

It is important for cadets to be able to signal search and rescue services should they become lost during an expedition. One method of signalling, which can identify a cadet's location by air or ground searchers, is the use of signal fires. Signal fires represent an important survival skill that may one day save a cadet's life.

Teaching Point 1**Determine Types of Emergency Signal Fires**

Time: 5 min

Method: Interactive Lecture



As each signal is discussed, show cadets an example of each. Make sure cadets fully understand how to ignite each fire.

EMERGENCY SIGNAL FIRES**Three Fire Triangle Pattern**

Three fires is the internationally recognized distress signal. Ideally, they should be placed in a triangle at equal distances apart, an arrangement which also makes them easier to feed with fuel. If this is not possible, any grouping will do, provided the fires are clearly separated. However, if fuel is scarce, or if one is too badly injured to maintain several fires, use only your campfire.

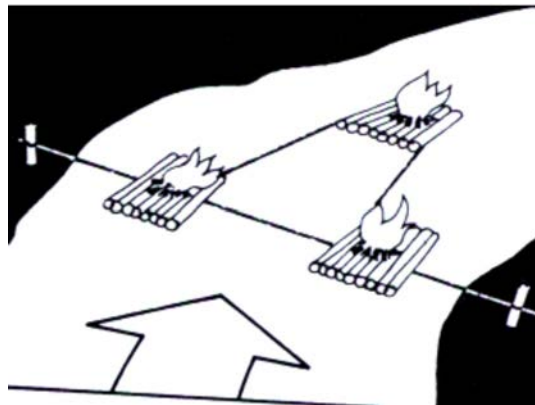


Figure 1 Three Fire Triangle Pattern

Wiseman, J., The SAS Survival Handbook, HarperCollins Publishers (p. 505)

A Torch Tree

Small isolated trees make excellent fire signals. Build a fire between the boughs by placing dry wood in the lower branches and ignite it so the flames flare up and ignite the foliage. Before the primary tree is consumed, cut and add more small green trees to the fire to produce more smoke. If a tree is dead, start a fire at its base. It will burn for a long time, leaving you free to attend to other signals.



Figure 2 A Torch Tree

*“Signalling Techniques”, by Wilderness Survival. Copyright 2007 by Jalic Inc.
Retrieved 12 March 2007, from <http://www.wilderness-survival.net/chpt19.php>*



Always select an isolated tree to ignite to avoid starting a forest fire.

Luminous Cone Fire

On a clear and open site, make a tripod with a platform to support a fire. The platform keeps the tinder off damp ground and elevates the fire allowing it to ignite the boughs. Additional fire wood can be stored beneath it. If available, cover the cone with brightly coloured material when the fire is not lit. This will not only keep the fire dry and ready to burn, but the material itself will be noticeable and may attract attention. Remove the brightly coloured material when lighting the fire.

Keep these tripods well maintained, ensuring that wood is dry enough to light at a moment's notice. These fires are not expected to last very long as the tripod is made of wood and wood burns! Be sure to light the signal fire when someone will see it (e.g. when one hears a plane).

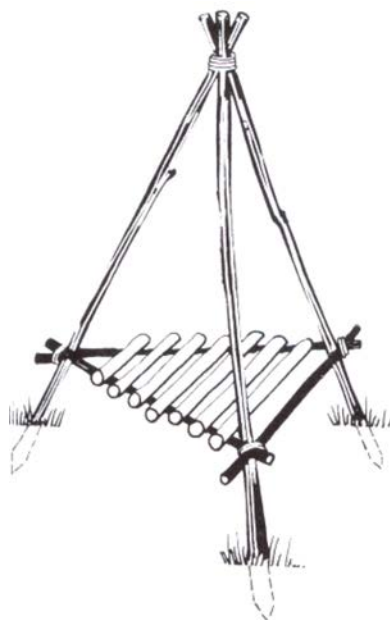


Figure 3 A Luminous Cone Fire

Wiseman, J., *The SAS Survival Handbook*,
HarperCollins Publishers (p. 506)



Figure 4 Cone Fire

Atlin Community Network Retrieved 12 March 2007,
from <http://www.atlin.net/Rangers.htm>

CONFIRMATION OF TEACHING POINT 1

QUESTIONS

- Q1. Name three types of emergency signal fires.
- Q2. Why is it important to make sure that a pot is stable when boiling?
- Q3. What is an internationally recognized distress signal?

ANTICIPATED ANSWERS

- A1. They are the three fire triangle pattern, the torch tree, and the luminous cone fire.
- A2. Always select an isolated tree so that you do not start a forest fire and endanger yourself and others.
- A3. An internationally recognized distress signal is three fires.

Teaching Point 2

Identify a Location to be Seen From the Air

Time: 5 min

Method: Interactive Lecture

BEST LOCATIONS FOR A SIGNAL FIRE TO BE SEEN FROM THE AIR

Elevated Ground. Choose the highest points of terrain for lighting signals.

Highly Visible. Find a natural clearing or the edge of a stream where one can build fires that foliage will not obscure the fire from overhead.

Fuel Source. Construct fires in an area where there are readily available fuel sources for the signal fire.

Examples of fuel sources include:

- dry, standing wood, and dry, dead branches;
- dry inside (heart) of fallen tree trunks and branches;
- green wood that is finely split;
- dry grasses twisted into bunches;
- peat dry enough to burn;
- dried animal dung;
- animal fats;
- coal, oil shale, or oil laying on the surface; and
- rubber, plastic or heavy oil to produce thick black smoke.

CONFIRMATION OF TEACHING POINT 2

QUESTIONS

- Q1. What is the best terrain for the location of a signal fire?
- Q2. What is a highly visible location?
- Q3. What are some examples of fuel sources?

ANTICIPATED ANSWERS

- A1. The highest point of terrain is the best location.
- A2. It is a natural clearing or edge of a stream.
- A3. Some examples of fuel sources are:
- dry, standing wood, and dry, dead branches;
 - dry inside (heart) of fallen tree trunks and branches;
 - green wood that is finely split;
 - dry grasses twisted into bunches;
 - peat dry enough to burn; dried animal dung;
 - coal, oil shale, or oil laying on the surface; and
 - rubber, plastic or heavy oil to produce thick black smoke.

Teaching Point 3**Prepare a Signal Fire**

Time: 20 min

Method: Demonstration

COMBUSTIBLE MATERIALS

Examples of combustible materials include birch bark, dry grass, fine wood shavings, bird down, waxed paper and cotton fluff from clothing.



The luminous cone fire that has been previously constructed can act as an example for demonstration purposes.

CONSTRUCTING A LUMINOUS CONE FIRE

To construct a luminous cone fire:

1. Locate three 2 m (about 6 feet) sticks about the thickness of an adult's wrist or thicker.
2. Stand sticks on end forming a tepee style structure. Sticks can be driven into the ground to make the structure secure.
3. Sticks should meet at a point leaving approximately 30 cm (1 foot) from the end. This will provide enough room to make a cone of boughs on top of the structure.
4. Lash the tripod together where all sticks meet.
5. Construct a platform approximately 45 cm to 60 cm below the point where the sticks meet.
6. The platform should be made of sticks that are wrist thick so when the fire is lit it will not burn rapidly through.
7. Place kindling and tinder on the platform that will easily light, producing a burst of fire.
8. Cover the top of the tripod with green boughs making a cone shape. The heat from the fire should travel directly into the cone.
9. When lit, tremendous amounts of smoke should be produced.

MAXIMIZING SIGNAL FIRE SMOKE

Smoke is a form of visual communication. Creating large amounts of smoke that are dark and can be seen over long distances is very simple. By lighting a fire and adding any of the following fuels, dark smoke will be created.

Smoke-creating fuels:

- leaves;
- green boughs;
- wet/damp wood; and
- rubber.

Maintaining Smoke. To maintain smoke, one must constantly cover the fire with fuel that causes smoke. Be cautious not to smother the fire. If green boughs are available, pile many on a fire and the smoke produced will be thick and dense. Boughs burn quickly. Be sure to have many on hand to maintain the smoke level.

Smoke can also be produced by covering the fire for a very short period of time. Covering the fire with a blanket and raising it quickly will produce a puff of smoke.

CONFIRMATION OF TEACHING POINT 3

QUESTIONS

- Q1. What holds the tinder and kindling in the centre of the tripod?
- Q2. What do you use to keep the cone dry?
- Q3. What prevents the tripod from tipping?

ANTICIPATED ANSWERS

- A1. The platform holds the tinder and kindling in the centre of the tripod.
- A2. Green boughs are used to keep the cone dry.
- A3. Ensure pole ends are driven into the ground to prevent tipping.

Teaching Point 4

Construct and Light a Luminous Cone Signal Fire as a Member of a Group

Time: 20 min

Method: Practical Activity

ACTIVITY

OBJECTIVE

The objective of this activity is to have cadets build a luminous cone fire.

RESOURCES

- String;
- Wood;
- Boughs;
- Tinder; and
- Kindling.

ACTIVITY LAYOUT

N/A.

ACTIVITY INSTRUCTIONS

1. Divide cadets into groups of no more than nine.
2. Have cadets gather tinder, kindling and sticks.

3. Have the cadets construct a cone fire by:
 - a. making a tripod to support a fire;
 - b. using the string to lash the top of the tripod together and the side supports together;
 - c. ensuring stick (pole) ends are driven into the ground to prevent tipping;
 - d. making a platform to hold the tinder, kindling and fuel;
 - e. placing tinder and kindling in the centre of the platform;
 - f. ensuring tinder and kindling are placed together in a fashion that will ignite the cone;
 - g. ensuring there is sufficient ventilation allowing oxygen to feed the fire when lit (a fire will suffocate if there is too much fuel);
 - h. covering with green boughs (if available) to keep the cone dry; and
 - i. ensuring there is a heat and smoke outlet at the top of the cone.



Ensure that all the cadets in the group participate in the activity.

If there are more than two groups, limit the number of signal fires to be lit. The burning of additional resources will waste materials and harm the environment.

Continually inspect the construction of each signal fire and periodically ask the cadets the questions in the confirmation of TP3 to ensure they are correctly assembling the signal fire.

SAFETY

Cadets will be supervised during the construction of the luminous cone fire.

END OF LESSON CONFIRMATION

The cadets' construction of a luminous cone fire in TP4 will serve as the confirmation of this lesson.

CONCLUSION

HOMEWORK/READING/PRACTICE

N/A.

METHOD OF EVALUATION

N/A.

CLOSING STATEMENT

When lost, the cadet will apply the S.T.O.P. principles. Planning will include construction of a signal fire. Knowing how to construct a signal fire in a survival situation will help attract help to the survival location. Safety is a key concern when dealing with fire. Principles of fire safety must be applied before lighting a fire.

INSTRUCTOR NOTES/REMARKS

N/A.

REFERENCES

C2-016 (ISBN 0-517-88783-5) Curtis, R. (1998). *The Backpacker's Field Manual: A Comprehensive Guide to Mastering Backcountry Skills*. New York, NY: Three Rivers Press.

C2-042 (ISBN 0-7566-0946-1) Berger, K. (2005). *Backpacking & Hiking*. New York, NY: DK Publishing, Inc.

C2-008 (ISBN 0-00-653140-7) Wiseman, J. (1999). *The SAS Survival Handbook*. Hammersmith, London: HarperCollins Publishers.

C3-118 Wilderness Survival. (2007). *Signalling Techniques*. Retrieved 12 March 2007, from <http://www.wilderness-survival.net/chpt19.php>.