

CHAPTER 6

PO 306 – FIRE THE CADET AIR RIFLE DURING RECREATIONAL MARKSMANSHIP



COMMON TRAINING
SILVER STAR
INSTRUCTIONAL GUIDE



SECTION 1

EO M306.01 – PARTICIPATE IN A RECREATIONAL MARKSMANSHIP ACTIVITY

Total Time:

90 min

PREPARATION

PRE-LESSON INSTRUCTIONS

Resources needed for the delivery of this lesson are listed in the lesson specification located in A-CR-CCP-703/PG-001, Chapter 4. Specific uses for said resources are identified throughout the instructional guide within the TP for which they are required.

Review the lesson content, unit range standing orders, and become familiar with the material prior to delivering the lesson.

Photocopy the targets located at Annexes B to J as required.

Construct a range IAW A-CR-CCP-177/PT-001, *Canadian Cadet Movement: Cadet Marksmanship Program Reference Manual*.

PRE-LESSON ASSIGNMENT

N/A.

APPROACH

A practical activity was chosen for this lesson as it is an interactive way to allow the cadet to experience recreational marksmanship in a safe and controlled environment. This activity contributes to the development of marksmanship skills and knowledge in a fun and challenging setting.

INTRODUCTION

REVIEW

The review for this lesson will be from EO M106.02 (Carry Out Safety Precautions on the Cadet Air Rifle, A-CR-CCP-701/PF-001, Chapter 6, Section 2).

QUESTIONS

- Q1. Why do we follow safety regulations?
- Q2. How would you verify the safety catch is ON?
- Q3. What are the four “ACTS” of firearm safety?

ANTICIPATED ANSWERS

- A1. We follow safety regulations to prevent accidents with the cadet air rifle.
- A2. When the safety is ON, no red can be seen.
- A3. The mnemonic "ACTS" stands for:
- Assume every firearm is loaded.
 - Control the muzzle direction at all times.
 - Trigger finger must be kept off the trigger and out of the trigger guard.
 - See that the firearm is unloaded (prove it safe).

OBJECTIVES

By the end of this lesson the cadet shall have participated in a recreational marksmanship activity.

IMPORTANCE

It is important for cadets to participate in a recreational marksmanship activity because it allows them to experience marksmanship in a fun, dynamic and safe setting.

Teaching Point 1

Supervise the Participation of the Cadet in a Recreational Marksmanship Activity

Time: 80 min

Method: Practical Activity



A range briefing is conducted to pass on vital information and answer any questions the cadets may have prior to participating in a marksmanship activity. The range briefing is required to ensure the safe execution of a marksmanship activity.

CONDUCT A RANGE BRIEFING

1. Explain pertinent sections of the local range standing orders.
2. Review general rules observed on all ranges, to include:
 - a. proving that rifles are safe prior to being picked up, handed to or received from another person;
 - b. never pointing rifles at people;
 - c. inserting safety rods into the barrels of rifles when not in use on the range;
 - d. never horseplaying on a range;
 - e. always pointing rifles down range; and
 - f. following the Range Safety Officer's (RSO) directions and orders at all times.



Review range commands with an explanation and demonstration for each command.

All loading/firing is to be simulated.

3. Review commands used on an air rifle range (as illustrated in Figure 6-1-1).

Command	Action to Be Taken
Cover Off Your Firing Point	Stand up, move behind the firing point and await further commands.
Place Your Equipment Down and Stand Back	Lay the equipment down on the mat and stand back when finished.
Adopt the Prone Position	Adopt the prone position, pick up the rifle, ready the equipment and put on hearing and eye protection.
Type of Firing (GRIT)	GRIT is the acronym for: <ol style="list-style-type: none"> 1. Group (relay), 2. Range (distance), 3. Indication (number of rounds), and 4. Type (grouping, scored).
Relay, Load	<ol style="list-style-type: none"> 1. Pick up and hold the rifle with the dominant hand. 2. Ensure the safety catch is in the "ON" position. 3. Pump the rifle, observing a three second pause. 4. Load a pellet (flat end forward). 5. Close the bolt.
Relay, Fire	<ol style="list-style-type: none"> 1. Place the safety catch in the "OFF" position. 2. Aim the rifle at the target. 3. Squeeze the trigger. 4. Open the bolt. 5. Repeat the following sequence for each shot: <ol style="list-style-type: none"> a. Pump the rifle, observing a three second pause. b. Load a pellet (flat end forward). c. Close the bolt. d. Aim the rifle at the target. e. Squeeze the trigger. f. Open the bolt. 6. Place the safety in the "ON" position. 7. Partially open the pump lever. 8. Lay down the rifle.

Director Cadets 3, 2006, Ottawa, ON: Department of National Defence

Figure 6-1-1 Air Rifle Range Commands

4. Describe the layout of the air rifle range.

5. Review hand-washing procedures on completion of firing. This is important because each time a person handles pellets, a small trace of lead is left on their hands. To decrease the risk of lead poisoning, it is important that all persons wash their hands thoroughly after handling pellets.

ACTIVITY

OBJECTIVE

The objective of this activity is to provide the cadet the opportunity to participate in a recreational marksmanship activity.

RESOURCES

- Cadet air rifle (one per firing lane),
- Cadet air rifle sling (one per cadet),
- Air rifle pellets,
- Target frame,
- Suitable target,
- Shooting mat,
- Safety glasses/goggles, and
- Pen/pencil.



Additional resources required for specific marksmanship activities may be found in the annexes.

ACTIVITY LAYOUT

N/A.

ACTIVITY INSTRUCTIONS

1. Brief cadets on safety rules or any other guidelines pertaining to the activity.
2. Divide the cadets into relays according to the number of firing lanes.
3. Conduct a recreational marksmanship activity, choosing from the following categories:
 - a. classification (see Annex A),
 - b. fun activities (see Annexes B to E),
 - c. timed activities (see Annexes F to H), or
 - d. competitive team/individual activities (see Annexes I and J).



If EO C306.03 (Adopt the Standing Position With the Cadet Air Rifle, Section 4) has been taught prior to this marksmanship activity, this EO may be conducted in the standing position.

SAFETY

Range activities will be conducted IAW A-CR-CCP-177/PT-001.

END OF LESSON CONFIRMATION

The cadets' participation in the activity will serve as the confirmation of this lesson.

CONCLUSION

HOMEWORK/READING/PRACTICE

N/A.

METHOD OF EVALUATION

N/A.

CLOSING STATEMENT

Marksmanship is a fun and exciting activity that requires personal discipline and teamwork skills. This activity has also developed into highly competitive levels at the provincial, regional, and national levels.

INSTRUCTOR NOTES/REMARKS

Hand-washing stations must be available for cleanup after the activity is completed.

Cadets may fire in the standing position if they have previously received the training during EO C306.03 (Adopt the Standing Position With the Cadet Air Rifle, Section 4).

REFERENCES

- A0-027 A-CR-CCP-177/PT-001 Director Cadets 3. (2005). *Canadian Cadet Movement: Cadet Marksmanship Program Reference Manual*. Ottawa, ON: Department of National Defence.
- A0-041 Director Cadets 4. (2007). CATO 14-41, *Marksmanship, Rifles and Ammunition*. Ottawa ON: Department of National Defence.



COMMON TRAINING
SILVER STAR
INSTRUCTIONAL GUIDE



SECTION 2

EO C306.01 – IDENTIFY CIVILIAN MARKSMANSHIP ORGANIZATIONS

Total Time:

30 min

PREPARATION

PRE-LESSON INSTRUCTIONS

Resources needed for the delivery of this lesson are listed in the lesson specification located in A-CR-CCP-703/PG-001, Chapter 4. Specific uses for said resources are identified throughout the instructional guide within the TP for which they are required.

Review the lesson content and become familiar with the material prior to delivering the lesson.

Consult the Internet or local telephone directory to identify the national, provincial and local civilian marksmanship organizations applicable to the corps.

PRE-LESSON ASSIGNMENT

N/A.

APPROACH

An interactive lecture was chosen for this lesson to orient the cadet to opportunities available to enhance their marksmanship training with civilian organizations.

INTRODUCTION

REVIEW

N/A.

OBJECTIVES

By the end of this lesson the cadet shall have identified opportunities to enhance their marksmanship training with civilian organizations.

IMPORTANCE

It is important for the cadets to identify local civilian marksmanship organizations and understand that the activities available through these organizations are personal and not supported by the Cadet Program. Civilian marksmanship organizations assist people who are interested in marksmanship.

Teaching Point 1**Discuss Local Civilian Marksmanship Organizations**

Time: 5 min

Method: Interactive Lecture



Inform the cadets of a local civilian marksmanship organization and identify available activities and requirements for membership.

Civilian marksmanship organizations and rifle associations are popular throughout the world and are found in many countries. Traditionally formed to augment the military, marksmanship organizations now have become governing bodies for civilians interested in marksmanship.

Local civilian marksmanship organizations exist in most major cities in Canada. These organizations can include the city or regional rifle associations or local rod and gun clubs. These organizations usually have a small calibre rifle range available for their members' use. To find local civilian marksmanship organizations, refer to the Internet or the local telephone listings.

CONFIRMATION OF TEACHING POINT 1**QUESTIONS**

- Q1. Why were civilian marksmanship organizations traditionally formed?
 Q2. What are some examples of these organizations?
 Q3. How would you find some organizations in your area?

ANTICIPATED ANSWERS

- A1. They were traditionally formed to augment the military.
 A2. City or regional rifle associations or local rod and gun clubs.
 A3. Refer to the internet or local telephone listings.

Teaching Point 2**Discuss the Applicable Provincial Rifle Organizations**

Time: 10 min

Method: Interactive Lecture

PROVINCIAL RIFLE ORGANIZATIONS

Select the rifle association for the province in which the cadet corps is located.



Civilian marksmanship organizations assist people interested in marksmanship to advance their skills in marksmanship. These activities are not supported by the Cadet Program.

Provincial rifle associations are the provinces' governing bodies on fullbore and smallbore target shooting. These associations exist to promote marksmanship within the province by organizing events and competitions. Provincial rifle associations also provide competitions for cadet units within their province. Provincial associations include:

Alberta Provincial Rifle Association. The Alberta Provincial Rifle Association (APRA) was created in 1902, as the Territorial Rifle Association, before the Province of Alberta was created. The objectives of the APRA are:

- to promote in every lawful way the interests of small arms marksmanship in the Province of Alberta;
- to promote annual prize meetings for individuals and teams and to offer prizes for skill in shooting;
- to encourage the establishment and maintenance of suitable ranges through legislation and private means;
- to assist in the formation of shooting clubs; and
- to create public interest for the encouragement of small arms shooting both as a sport and as a necessary means of national defence;

The APRA can be found on the Internet at www.albertarifle.com.

British Columbia Rifle Association. The British Columbia Rifle Association (BCRA) was created in 1874, incorporated in 1910, and is one of the oldest members of the British Columbia Societies Act. The objectives of the BCRA are:

- to create a public sentiment for the encouragement of small arms shooting as a sport; and
- the control and safe handling of firearms and as a necessary part of national defence.

Through the Department of National Defence, members are permitted to participate in shooting events held on military rifle ranges in British Columbia.

The BCRA can be found on the Internet at www.bcrifle.org.

Manitoba Provincial Rifle Association. The Manitoba Provincial Rifle Association Inc. (MPRA) was created in 1872, for the purpose of encouraging rifle shooting among the militia and citizens of Manitoba. The objectives of the MPRA are:

- to enhance the perception of shooting as a sport by encouraging and supporting all athletes involved in shooting to achieve their maximum performance levels; and
- to promote safe firearms handling.



The Honourable D.A. Smith (Lord Strathcona) was a patron of the MPRA for 40 years. He took an interest in shooting and donated many prizes, especially to cadets.

The MPRA can be found on the Internet at www.manitobarifle.ca.

Newfoundland Provincial Rifle Association. The Newfoundland Provincial Rifle Association can be contacted through the Dominion of Canada Rifle Association (DCRA).

Nova Scotia Rifle Association. The Nova Scotia Rifle Association (NSRA) was created in 1861, and is the oldest provincial rifle association. The objectives of the NSRA are:

- to foster the safe and responsible use of firearms, and

- to develop marksmanship skills.

The NSRA can be found on the Internet at www.nsrifle.org.

Ontario Provincial Rifle Association. The Ontario Provincial Rifle Association (ORA) was created in 1868. The objectives of the ORA are:

- to provide opportunities for shooting with different types of rifles; and
- offer programs for marksman from beginner to world class.

The ORA can be found on the Internet at www.ontariorifleassociation.org.

Prince Edward Island Rifle Association. The Prince Edward Island Rifle Association can be contacted through the DCRA.

Province of Quebec Rifle Association. The Province of Quebec Rifle Association (PQRA) was created in 1869 and supports various shooting clubs and associations. The objective of the PQRA is to teach and promote marksmanship in competitive and recreational environments, where safety is first and foremost.

The PQRA can be found on the Internet at www.pqra.org.

Royal New Brunswick Rifle Association. The Royal New Brunswick Rifle Association (RNBRA) was created in 1866 to serve all shooting and related disciplines in New Brunswick. The objectives of the RNBRA are to promote:

- good sportsmanship,
- safe, efficient and practical arms handling, and
- good marksmanship by civilians, civic police and the military.

The RNBRA can be found on the Internet at www.rnbra.ca.

Saskatchewan Provincial Rifle Association. The Saskatchewan Provincial Rifle Association (SPRA) is the governing body for fullbore target rifle shooting in Saskatchewan. The objectives of the SPRA are to promote:

- the pursuit of excellence in marksmanship; and
- the safe and responsible handling of firearms.

The SPRA can be found on the Internet at www.saskrifle.ca.

CONFIRMATION OF TEACHING POINT 2

QUESTIONS

- Q1. What is the objective of provincial rifle associations?
- Q2. How do these rifle associations meet this objective?
- Q3. How do these associations support the cadet movement?

ANTICIPATED ANSWERS

- A1. To promote marksmanship within the province.
- A2. By organizing marksmanship events and competitions.

A3. By providing competitions for cadet units within their province.

Teaching Point 3

Discuss National Marksmanship Organizations

Time: 5 min

Method: Interactive Lecture

NATIONAL MARKSMANSHIP ORGANIZATIONS

The DCRA

The DCRA, headquartered at Connaught Ranges Primary Training Centre, Ottawa, Ont., is Canada's national governing body for fullbore and smallbore target shooting. The DCRA was founded in 1868 and incorporated by parliament in 1890, to encourage marksmanship training in response to the departure of the British military and the Fenian Raids in 1866.



The Fenian Raids were attacks on British targets in Canada between 1866 and 1871, to pressure Britain to withdraw from Ireland. Most of the raids were successfully repelled by British forces and local militias.

The DCRA continues to promote excellence in civilian and military marksmanship.

The DCRA works with the CCM by organizing events and competitions including postal championships held for cadet units across the country and summer matches for the National Rifle Team (NRT) and Canadian and British army cadets on CSTC courses at Connaught NACSTC.

The DCRA can be found on the internet at www.dkra.ca.



Section One of the DCRA postal championships are matches that are restricted to sea, army and air cadets. Section Two is open to any junior team and cadets are encouraged to enter.

The Shooting Federation of Canada (SFC)

The SFC, headquartered at Connaught Ranges Primary Training Centre, Ottawa, Ont., is Canada's national sport governing body for recreational and competitive target shooting in Canada. The SFC is the authority for the marksmanship technical training portion of the National Coaching Certification Program (NCCP).

The SFC can be found on the internet at www.sfc-ftc.ca.

CONFIRMATION OF TEACHING POINT 3

QUESTIONS

- Q1. What are the two National Marksmanship Organizations in Canada?
- Q2. How does the DCRA work with the NRT?
- Q3. How does the DCRA work with cadet units across Canada?

ANTICIPATED ANSWERS

- A1. The Dominion of Canada Rifle Association and the Shooting Federation of Canada.

A2. The DCRA works with the NRT by organizing events and competitions during the summer.

A3. The DCRA conducts postal matches held for cadet units across the country.

Teaching Point 4

Identify the Applicable National/Provincial Biathlon Organizations

Time: 5 min

Method: Interactive Lecture

BIATHLON CANADA

Biathlon Canada is the governing body for the sport of biathlon within Canada. Biathlon Canada organizes many events, competitions and programs, including the Biathlon Bears Program, which is a community program, offered across Canada. The Biathlon Bears program is open to novices and the training is tailored to the athlete's skill level. This program offers training to develop both skiing and marksmanship skills. As skills are learned and mastered, the biathlete progresses to the next Biathlon Bear level.

PROVINCIAL AND TERRITORIAL BIATHLON ORGANIZATIONS

Divisions of Biathlon Canada are located within many of the provinces and territories. These division offices run training and offer support to the local resorts/clubs. These divisions include:

- Biathlon Alberta,
- Biathlon British Columbia,
- Biathlon Manitoba,
- Biathlon New Brunswick,
- Biathlon Nova Scotia,
- Biathlon Newfoundland and Labrador,
- Biathlon Ontario,
- Biathlon Quebec,
- Biathlon Saskatchewan,
- Biathlon Yukon, and
- Northwest Territories Biathlon.

CONFIRMATION OF TEACHING POINT 4

QUESTIONS

Q1. What organization is the governing body for the sport of biathlon within Canada?

Q2. What community biathlon program is offered across Canada?

Q3. What are the objectives of the provincial and territorial organizations?

ANTICIPATED ANSWERS

A1. Biathlon Canada is the governing body within Canada.

- A2. Biathlon Bears is offered across Canada.
- A3. To run training and offer support to the local resorts/clubs.

END OF LESSON CONFIRMATION

QUESTIONS

- Q1. What are the Canadian national marksmanship organizations?
- Q2. What marksmanship organizations are in your province/territory?
- Q3. Which of these organizations is your cadet corps active with?

ANTICIPATED ANSWERS

- A1. The DCRA, SFC and Biathlon Canada.
- A2. Answers will vary by province/territory.
- A3. Answers will depend on cadet corps.

CONCLUSION

HOMEWORK/READING/PRACTICE

N/A.

METHOD OF EVALUATION

N/A.

CLOSING STATEMENT

Identifying opportunities with civilian marksmanship organizations, one will know where they can acquire additional marksmanship training that is not supported by the Cadet Program. The opportunities provided by these organizations could enhance one's sense of accomplishment through improved marksmanship skills and allow them to choose activities in which they would like to participate.

INSTRUCTOR NOTES/REMARKS

Have the cadets identify only the applicable national, provincial and local marksmanship organizations.

REFERENCES

- A0-119 Shooting Federation of Canada. (2007). *Shooting Federation of Canada*. Retrieved November 2, 2007, from www.sfc-ftc.ca/document.cfm?sectionID=39.
- C0-149 Biathlon Canada. (2005). *Biathlon Bears: Community Coaching*. Ottawa, ON: Biathlon Canada.
- C2-086 Dominion of Canada Rifle Association. (2007). *History*. Retrieved October 4, 2007, from www.dkra.ca/history.htm.

THIS PAGE INTENTIONALLY LEFT BLANK



COMMON TRAINING
SILVER STAR
INSTRUCTIONAL GUIDE



SECTION 3

EO C306.02 – CORRECT MARKSMANSHIP ERROR

Total Time:	60 min
-------------	--------

PREPARATION

PRE-LESSON INSTRUCTIONS

Resources needed for the delivery of this lesson are listed in the lesson specification located in A-CR-CCP-703/PG-001, Chapter 4. Specific uses for said resources are identified throughout the instructional guide within the TP for which they are required.

Review the lesson content and become familiar with the material prior to delivering the lesson.

Photocopy Annexes K and L for each cadet.

Photocopy the answer key located at Annex M for the instructor and assistant instructors.

Set up a mock firing point.

PRE-LESSON ASSIGNMENT

N/A.

APPROACH

An interactive lecture was chosen for TPs 1–3 to give an overview of the theories and the practice of adjusting sights.

A practical activity was chosen for TP 4 as it is an interactive way to introduce and allow cadets to experience adjusting sights on the cadet air rifle in a controlled environment. This activity contributes to the development of sight adjustment skills and knowledge in a fun and challenging setting.

INTRODUCTION

REVIEW

N/A.

OBJECTIVES

By the end of this lesson the cadet is expected to correct marksmanship error by adjusting elevation and windage on the cadet air rifle.

IMPORTANCE

It is important for the cadets to learn how to correct marksmanship error in order to zero the cadet air rifle when participating in a marksmanship activity. A zeroed rifle will give the marksman the assurance that the centre of the target is properly aligned with themselves and their rifle. Having a zeroed rifle and knowing how to zero a rifle is important to every marksman in order to achieve a higher score in application activities.

Teaching Point 1

Explain Centring the Group

Time: 10 min

Method: Interactive Lecture

THE THEORY OF A GROUP

When a series of three or more shots are fired from the same point of aim, they will seldom pass through the same point on the target. The pattern that is produced from the shot holes in the target is called a group.

Factors Affecting the Group

There are three factors that affect the shape and size of the group:

- **The Ammunition.** Even though every pellet is manufactured to be exactly the same, slight variations in each pellet will result in slight variations in results when firing. The number of pellets used will also affect the group size.
- **The Rifle.** Each rifle will fire a pellet with its own slight variation due to small differences in the barrel and firing mechanisms.
- **The Marksman.** Factors associated with the marksman's aiming, holding, breathing and follow-through techniques will affect each shot.

MEAN POINT OF IMPACT (MPI)



Ensure the handout located at Annex K is passed out to the cadets during this portion of the lesson to allow the cadets to see how the MPI moves as more pellets are shot into the target.

The MPI is the point on the target which is the average centre between all shots on the target. As each shot is fired, the MPI changes as the group develops. To centre the group correctly, corrections should be based on the MPI.

To determine the MPI, each shot must be evaluated. It takes at least two shots for an MPI to be determined. For two shots, the MPI will be the point centred between the two shots. After firing three shots, the MPI will change so that the MPI is centred between all three shots (as illustrated in Figure 6-3-1).

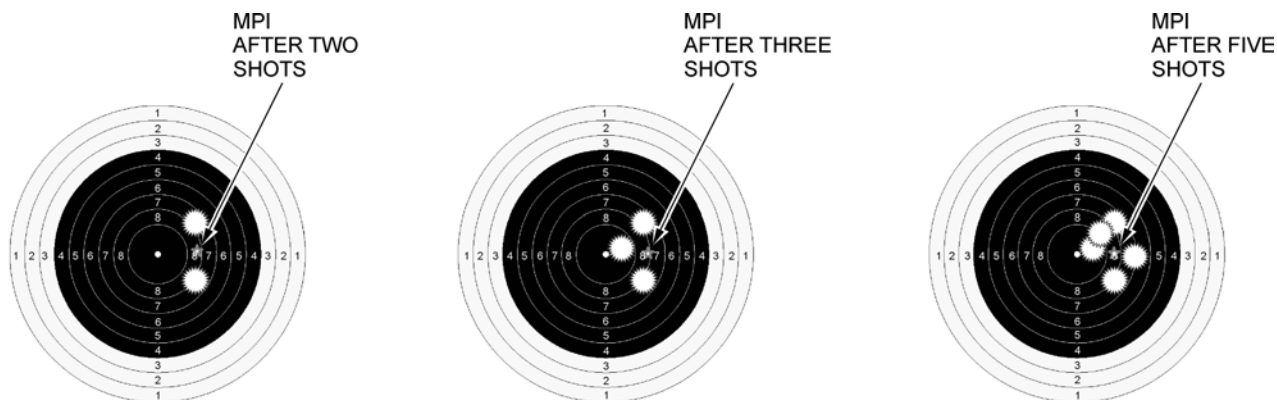

Director Cadets 3, 2007, Ottawa, ON: Department of National Defence

Figure 6-3-1 MPI Examples

CONFIRMATION OF TEACHING POINT 1

QUESTIONS

- Q1. Define the term group.
- Q2. What are the three factors that affect the size and shape of the group?
- Q3. What is the definition of MPI?

ANTICIPATED ANSWERS

- A1. The pattern that is produced from the shot holes in a target.
- A2. The three factors that affect the shape and size of the group:
 - the ammunition,
 - the rifle, and
 - the marksman.
- A3. The MPI is the point on the target which is the average centre between all shots on the target.

Teaching Point 2

Time: 10 min

Explain Sight Adjustment

Method: Interactive Lecture

THE PURPOSE OF SIGHT ADJUSTMENT

Sight adjustment is used to ensure that the rifle is zeroed to the marksman. Sight adjustment will not make up for poor marksmanship skills, but may aid the proficient marksman in aligning their grouping to a target. There are two different ways a sight can be adjusted in order to zero the rifle: the windage and the elevation.

ELEVATION

Elevation affects the pellet by moving its vertical position, which moves the point of impact up or down the target. It compensates for the trajectory drop of the pellet.

WINDAGE

Windage affects the pellet by moving its horizontal position, which moves the point of impact left or right. It compensates for the direction and force of the wind on the pellet.

A ZEROED CADET AIR RIFLE

A zeroed cadet air rifle is accurate for a particular marksman at a particular position and distance from the target. A zeroed cadet air rifle has a particular sight setting that will be perfectly aimed, by putting pellets directly into the centre of the target.

CONFIRMATION OF TEACHING POINT 2

QUESTIONS

- Q1. What is the purpose of adjusting the sights on a rifle?
- Q2. What does the elevation adjustment refer to?
- Q3. What does the windage adjustment refer to?

ANTICIPATED ANSWERS

- A1. Sight adjustment is used to ensure the rifle is zeroed to the marksman.
- A2. Elevation adjustment refers to the adjustment required to compensate for the trajectory drop of the pellet.
- A3. Windage adjustment refers to the adjustment required to compensate for the direction and force of the wind on the pellet.

Teaching Point 3

Explain the Increments of Sight Adjustment

Time: 5 min

Method: Interactive Lecture



Ensure the cadets have a cadet air rifle in front of them during this portion of the lesson in order to see the actual sight of the cadet air rifle and the means in which it functions.

SIGHT ADJUSTMENT OF THE CADET AIR RIFLE

Sight adjustment of the cadet air rifle is achieved by turning the knobs of the rear sight. The elevation adjustment knob is found on the top of the rear sight and the windage elevation knob is found on the right-hand side of the rear sight. They are used to move the MPI of the shot either left or right and up or down. The adjustment of these knobs is measured in clicks that can be felt as the knob is turned. It takes three clicks to move the point of impact approximately one pellet width in any direction.



At a distance of 10 m, each click equals approximately a 1.219 mm shift of the MPI.

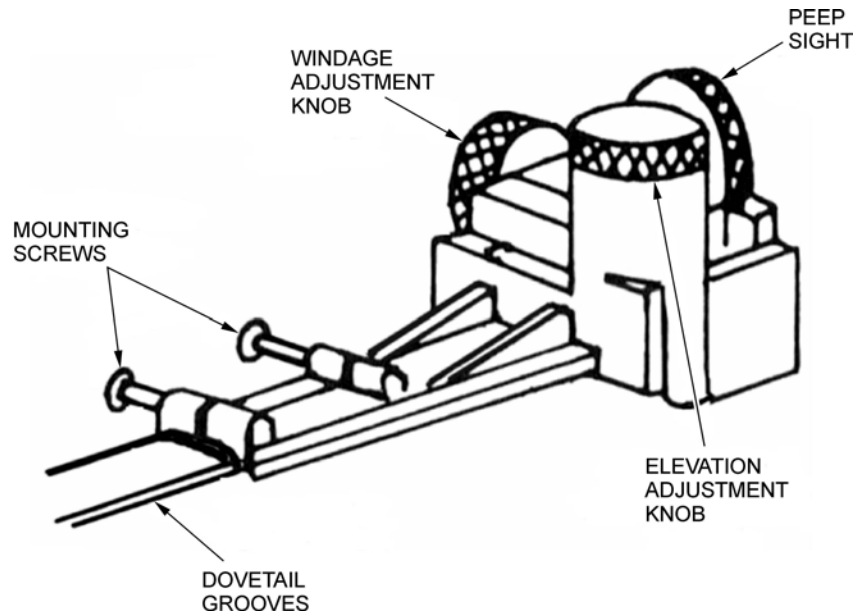

Rogers, AR., *AVANTI Competition Pellet Rifle: Operation Manual: AVANTI Legend Model 853, Daisy Outdoor Products (p. 6)*

Figure 6-3-2 Rear Sight of the Cadet Air Rifle

LOWERING AND RAISING THE ELEVATION

To lower the elevation of the MPI, turn the elevation knob counter-clockwise (to the left). To raise the elevation of the MPI, turn the elevation knob clockwise (to the right), as per the arrow and the word "UP" located on the knob.

MOVING THE WINDAGE LEFT AND RIGHT

To move the MPI left, turn the windage knob counter-clockwise (to the left). To move the MPI to the right, turn the windage knob clockwise (to the right), as per the arrow and the letter "R" located on the knob.



In order to move the MPI up and to the right turn the elevation and windage knobs clockwise.

In order to move the MPI down and left turn the elevation and windage knobs counter-clockwise.

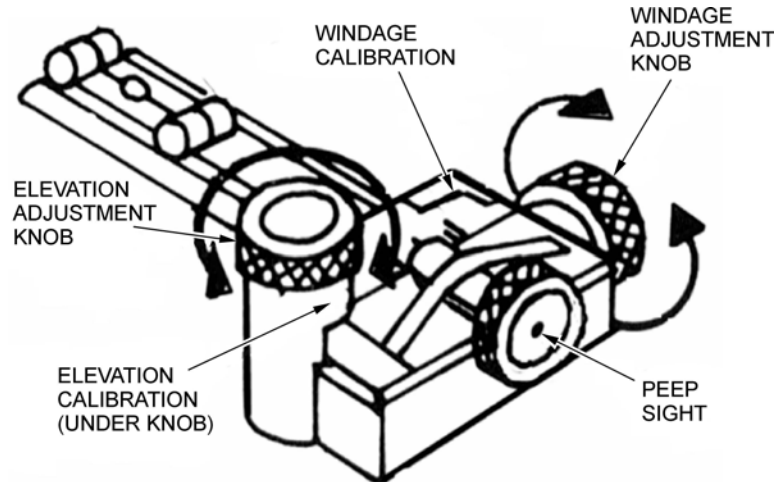

Rogers, AR., *AVANTI Competition Pellet Rifle: Operation Manual: AVANTI Legend Model 853, Daisy Outdoor Products* (p. 6)

Figure 6-3-3 Sight Adjustment of the Cadet Air Rifle

CONFIRMATION OF TEACHING POINT 3

QUESTIONS

- Q1. How many clicks on the adjustment knob will move the MPI on the target one pellet width in any direction?
- Q2. What direction does the marksman turn the elevation adjustment knob in order to raise the MPI?
- Q3. What direction does the marksman turn the windage adjustment knob in order to move the MPI to the left?

ANTICIPATED ANSWERS

- A1. In order to move the MPI on the target one pellet width, three clicks are required.
- A2. The marksman turns the elevation adjustment knob clockwise (to the right) in order to raise the MPI.
- A3. The marksman turns the windage adjustment knob counter-clockwise (to the left) in order to move the MPI to the left.

Teaching Point 4

Conduct a Sight Adjustment Exercise

Time: 30 min

Method: Practical Activity



Each pair of cadets will complete the exercise located at Annex L and then practice adjusting their sights.

An assistant instructor may be used to aid the cadets in the completion of this activity.

ACTIVITY

OBJECTIVE

The objective of this activity is to confirm that each cadet can determine the MPI and adjust sights accordingly on the cadet air rifle.

RESOURCES

- Cadet air rifle (one per firing lane),
- Sight adjustment activity targets located at Annex L, and
- Pencil/pen.

ACTIVITY LAYOUT

A mock firing point.

ACTIVITY INSTRUCTIONS

1. Divide the cadets into pairs.
2. Distribute the exercise located at Annex L to each cadet.
3. Have the cadets, in pairs, determine the MPI of all five shots for each scoring diagram.
4. Have the cadets put an asterisk to indicate the MPI.
5. Have the cadets determine the vertical and horizontal distance, in clicks, that the MPI must move to be aimed at the centre of the target.
6. Have the cadets write the number of clicks required for the windage and elevation, marking whether to turn the knob clockwise (cw) or counter-clockwise (ccw).
7. Have the cadets practice adjusting the sights on the cadet air rifle for each scoring diagram.
8. Correct using the answer key located at Annex M.

SAFETY

Ensure the following:

- the cadet air rifles are safe by performing individual safety precautions IAW A-CR-CCP-177/PT-001;
- all cadet air rifles are pointed in a safe direction throughout the lesson;
- no pellets or cleaning pellets are present in the training area; and
- all other applicable safety regulations are followed IAW local range standing orders.

CONFIRMATION OF TEACHING POINT 4

The cadets' participation in the activity will serve as the confirmation of this TP.

END OF LESSON CONFIRMATION

The cadets' participation in the sight adjustment exercise will serve as the confirmation of this lesson.

CONCLUSION

HOMEWORK/READING/PRACTICE

N/A.

METHOD OF EVALUATION

N/A.

CLOSING STATEMENT

Correcting marksmanship error is necessary to achieve success in marksmanship activities. It ensures that the marksman, the rifle and the target are aligned and that the centre of aim is in the centre of the target. It is important for each marksman to understand how to adjust their sights in order to achieve a completely aligned rifle.

INSTRUCTOR NOTES/REMARKS

N/A.

REFERENCES

- A0-027 A-CR-CCP-177/PT-001 Director Cadets 3. (2001). *Canadian Cadet Movement: Cadet Marksmanship Program Reference Manual*. Ottawa, ON: Department of National Defence.
- C2-097 Ontario Rifle Association. (2003). *Ontario Rifle Association Handbook for New Member*. Haliburton County, ON: MilCun Marksmanship Complex.
- C2-098 (ISBN 1-931220-05-0) Constantine, R. (1998). *Modern Highpower Competition: From Beginner to Master*. Manchester, CT: Precision Shooting Inc.



COMMON TRAINING
SILVER STAR
INSTRUCTIONAL GUIDE



SECTION 4

EO C306.03 – ADOPT THE STANDING POSITION WITH THE CADET AIR RIFLE

Total Time:

60 min

PREPARATION

PRE-LESSON INSTRUCTIONS

Resources needed for the delivery of this lesson are listed in the lesson specification located in A-CR-CCP-703/PG-001, Chapter 4. Specific uses for said resources are identified throughout the instructional guide within the TP for which they are required.

Review the lesson content and become familiar with the material prior to delivering the lesson.

PRE-LESSON ASSIGNMENT

N/A.

APPROACH

An interactive lecture was chosen for TP 1 to give an overview of the objectives of the standing position.

Demonstration was chosen for TPs 2–4 as it allows the instructor to explain and demonstrate aspects of the standing position.

A practical activity was chosen for TP 5 as it is an interactive way to allow the cadet to experience the standing position in a safe and controlled environment. This activity contributes to the development of marksmanship skills and knowledge in a fun and challenging setting.

INTRODUCTION

REVIEW

N/A.

OBJECTIVES

By the end of this lesson the cadet shall be expected to adopt the standing position with the cadet air rifle.

IMPORTANCE

It is important for cadets to adopt the standing position with the cadet air rifle as this position is used in both biathlon and civilian air rifle competitions. As the standing position is the only position for the international air rifle competitions, it is seen as a progression for cadet recreational marksmanship.

Teaching Point 1**Explain the Objectives of the Standing Position**

Time: 5 min

Method: Interactive Lecture

The first principle of marksmanship is to find a comfortable firing position. The standing position is the easiest and quickest position to assume and does not require any artificial support like the sling in the prone position. It is the most difficult position in which to remain steady as it has the smallest area of support and it has a high centre of gravity. Cadets must accept that when firing in the standing position, they may never achieve complete immobility.

OBTAINING A GOOD POSITION

Obtaining a good position is the most important principle of marksmanship; this is especially true when firing in the standing position. A good position helps to maintain balance, comfort and stability during firing. Cadets should wear comfortable flat sole shoes or boots to add stability to the position and stand on the firmest surface possible. Although an excellent position will not guarantee an excellent performance, a poor position can almost assure a substantially negative effect on one's score.

The objective of a good position is to obtain a stable, balanced, uniform platform in the most efficient way possible allowing holding and aiming to be achieved with as little movement and muscular tension as possible.

The standing position should be:

- natural,
- without strain,
- comfortable,
- stable,
- balanced in such a way that body weight is equally distributed between both feet, and
- consistent throughout the relay.

USING A RIFLE REST

An excellent way for a cadet to learn the standing position is to practice with the use of a rifle rest. Since the movements of the cadet air rifle are amplified from the lack of support points with the standing position, a rifle rest is very helpful. This allows the cadet air rifle to remain steady while allowing the cadet to understand and perfect the marksmanship skills being practiced. Once these skills are learned, the rifle rest should be removed. Some examples of rifle rests for the standing position are a tripod stand, a stool on top of a table or simply a flat surface on the end of a broom stick.

MAINTAINING A CENTRE OF GRAVITY

The instructions given are based on a right-handed marksman. For a left-handed marksman, substitute the left for right and right for left throughout the points.

The centre of gravity is the point where the weight of the rifle and the cadet's body weight are evenly distributed between the feet. In order to compensate for the weight of the rifle, the cadet's back is bent rearward and rotated to the left in order to gain bone support and stability.

If the cadet stands straight, the weight of the cadet air rifle will pull their body to the front. Muscle strain will be felt in the back as the cadet attempts to keep their body from falling forward. By bending backward and rotating the back to the left, a shift in body weight will occur slightly towards the right foot. At a certain point, the weight of the body on the right foot will equal the weight on the left foot. The body-rifle combination then reaches a state of balance, with the centre of gravity located between the cadet's two feet.

CONFIRMATION OF TEACHING POINT 1

QUESTIONS

- Q1. What is the first principle of marksmanship?
- Q2. What is an excellent way for a cadet to learn the standing position?
- Q3. What is the centre of gravity in relation to the standing position?

ANTICIPATED ANSWERS

- A1. Obtaining a good position.
- A2. With the use of a rifle rest.
- A3. The centre of gravity is the point where the weight of the rifle and the cadet's body weight are evenly distributed between the feet.

Teaching Point 2

Explain and Demonstrate Adopting the Standing Position

Time: 5 min

Method: Demonstration



For this TP, it is recommended that instruction take the following format:

1. Explain and demonstrate the complete skill while cadets observe.
2. Explain and demonstrate each step required to complete the skill.

Note: Assistant instructors may be employed to demonstrate the skill as it is explained.



No two bodies are exactly the same, not even twins; therefore, no two bodies will look alike in any shooting position. Building the best position for your performance, means your standing position will differ from the person standing beside you.

ADOPTING THE STANDING POSITION

The following guidelines should be adhered to when adopting the standing position:

1. the body should face to the right, approximately 90 degrees to the target;
2. the feet should be:
 - a. positioned shoulder width apart,
 - b. pointed straight ahead in relation to the body, or
 - c. turned slightly outward for comfort;



The weight of the body and the rifle should be equally distributed between both feet.

3. the legs should be straight with knees unlocked, as locked knees affect circulation, causing increased discomfort and unsteadiness;
4. the hips should be 90 degrees to the target and should not thrust forward;

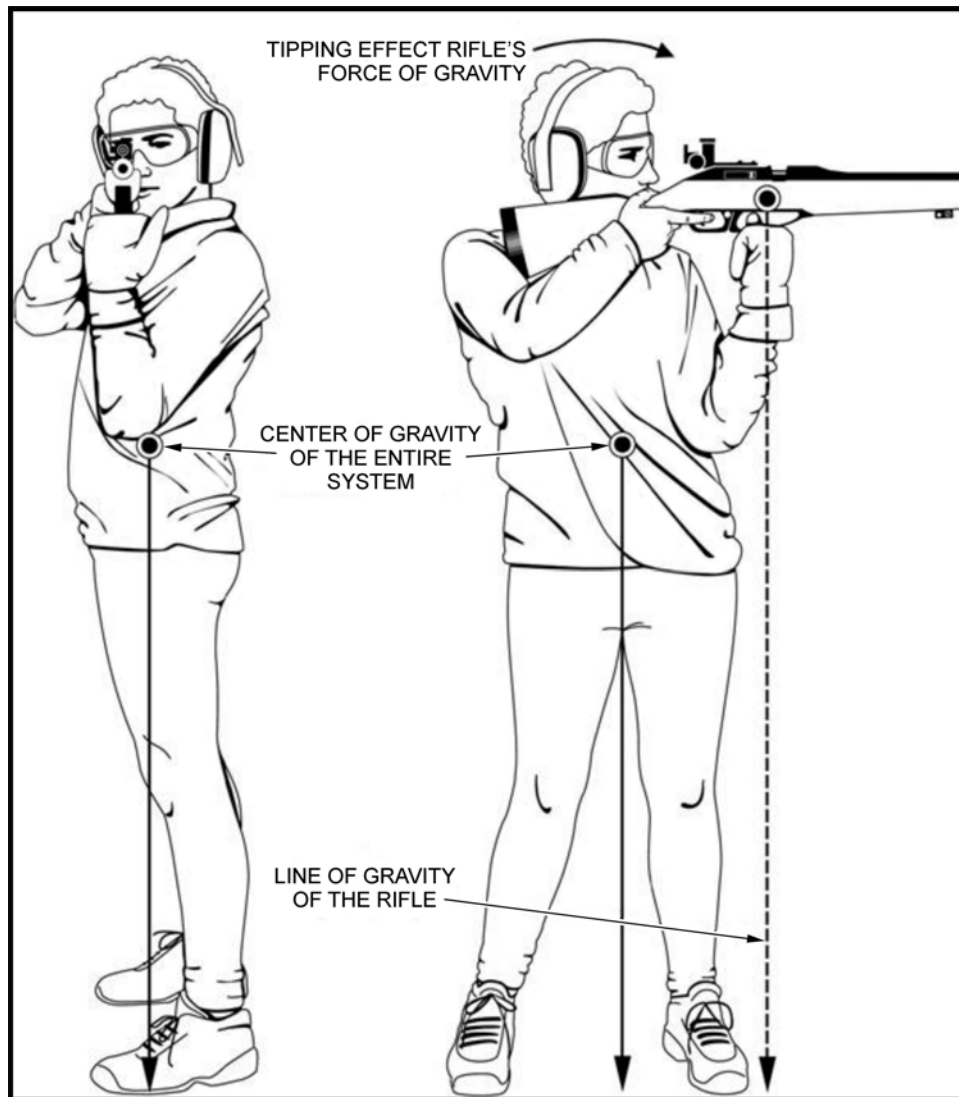

A-CR-CCP-177/PT-001 (p. 2-9)

Figure 6-4-1 Standing Position

5. the back should be bent rearward to gain bone support and stability;
6. the left arm, without muscles used for support, should rest against the ribcage with the elbow almost directly under the rifle, resting against the ribcage or hipbone;
7. the left hand is used to support the rifle and should be positioned on the pump handle, using one of the following methods:

- a. forming a clenched fist;



A-CR-CCP-177/PT-001 (p. 1-6-3)

Figure 6-4-2 Clenched Fist

- b. forming a V shape with the thumb and fingers; or



A-CR-CCP-177/PT-001 (p. 1-6-3)

Figure 6-4-3 V Shape With the Thumb and Fingers

- c. using the heel of the hand with relaxed fingers;



A-CR-CCP-177/PT-001 (p. 1-6-4)

Figure 6-4-4 Heel of the Hand

8. the right arm should drop naturally to the side with the right hand placed comfortably, but firmly on the small of the butt;
9. the head should remain in an upright and natural position to allow the eyes to look forward through the sights; and

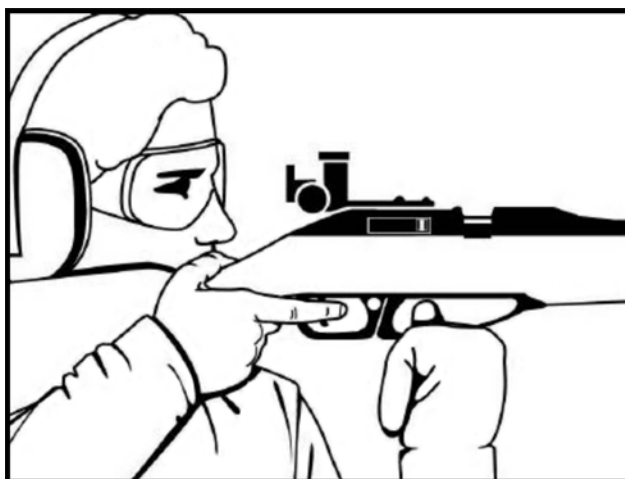

A-CR-CCP-177/PT-001 (p. 1-6-4)

Figure 6-4-5 Head and Eyes

10. the butt should rest slightly high on the shoulder, allowing the cadet air rifle to rest naturally across the chest with the cheek resting on the stock and the sights at eye level.



The standing position allows for a more natural and relaxed position that is more comfortable than prone, as it places less pressure and weight on the spine.

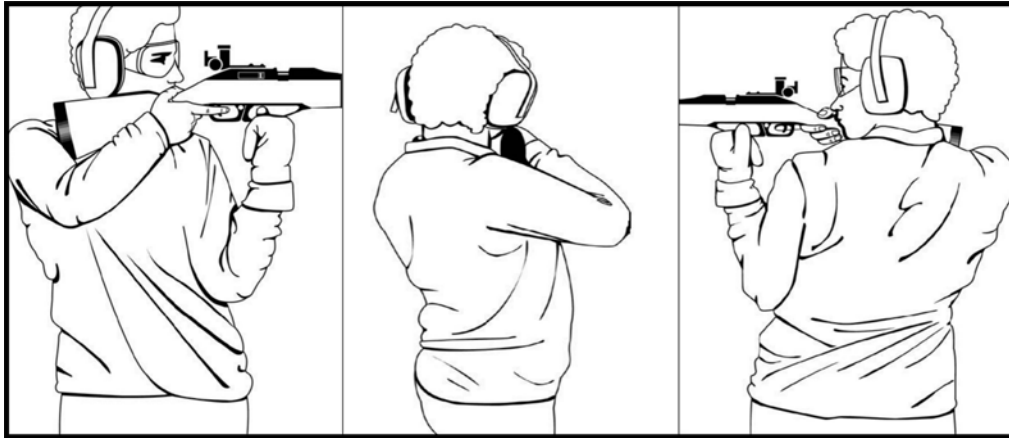

A-CR-CCP-177/PT-001 (p. 2-9)

Figure 6-4-6 Back and Hip Position

CONFIRMATION OF TEACHING POINT 2

QUESTIONS

- Q1. Why is the back bent rearward?
- Q2. Why should the head remain in an upright and natural position?
- Q3. Where should the butt of the cadet air rifle rest?

ANTICIPATED ANSWERS

- A1. The back is bent rearward to gain bone support and stability.
- A2. The head should remain in an upright and natural position to allow the eyes to look forward through the sights.
- A3. The butt resting slightly high on the shoulder, allowing the cadet air rifle to rest naturally across the chest with the cheek resting on the stock and the sights at eye level.

Teaching Point 3

Explain and Demonstrate Adjusting the Aim

Time: 5 min

Method: Demonstration



When firing in the standing position, the larger of the two front apertures should be selected to provide the best sight picture. The aperture size should appear 1-1/2 times bigger than the aiming mark to allow the cadet to see the aiming mark that will be shifting around more than in the prone position.

When aiming the cadet air rifle in the standing position, the aiming process is the same as it is for the prone position. It is achieved by adopting a comfortable position, ensuring body alignment with the target, sight alignment and obtaining a sight picture. The only thing that varies from the prone position is that the front aperture should be larger and eye relief may be longer, but still between 5–15 cm (2–6 inches).



For this TP, it is recommended that instruction take the following format:

1. Explain and demonstrate the complete skill while cadets observe.
2. Explain and demonstrate each step required to complete the skill.

Note: Assistant instructors may be employed to demonstrate the skill as it is explained.

Higher

To adjust the aim higher in the standing position, move the left hand rearward, closer to the trigger guard.

Lower

To adjust the aim lower in the standing position, move the left hand forward, away from the trigger guard.



When smaller adjustments higher or lower are required, they can be achieved by adjusting when to hold a breath during the breathing cycle.

Left and Right

To adjust the aim to the left or right, adjustments are made by moving both feet in such a way as to keep them in the same position in relation to each other. The result should be as if the position was rotated in a disc, turned to the left or right as required.



When smaller adjustments left or right are required, they can be achieved by adjusting the position of the left hand and forearm. Adjusting the aim by this method may result in having to acquire a new firing position.

CONFIRMATION OF TEACHING POINT 3

QUESTIONS

- Q1. How does aiming in the standing position vary from the prone position?
- Q2. How is aiming adjusted higher or lower in the standing position?
- Q3. How is aiming adjusted to the left or right in the standing position?

ANTICIPATED ANSWERS

- A1. The front aperture should be larger and eye relief may be longer, but still between 5–15 cm (2–6 inches).
- A2. By moving the left hand rearward or forward of the trigger guard.
- A3. By moving both feet in such a way as to keep them in the same position in relation to each other, as if on a rotating disc.

Teaching Point 4**Explain and Demonstrate Natural Alignment**

Time: 5 min

Method: Demonstration



Natural alignment is the same procedure for the standing position as it is for the prone position.

Natural alignment describes the direction that the cadet air rifle is aimed when the marksman is in a comfortable standing position with the cadet air rifle at the ready. In a comfortable position, the cadet air rifle should not be forced to point at the target. Even with a comfortable standing position and sight alignment, forcing the cadet air rifle can cause muscle tension and will affect the accuracy of each shot.



For this TP, it is recommended that instruction take the following format:

1. Explain and demonstrate the complete skill while cadets observe.
2. Explain and demonstrate each step required to complete the skill.

Note: Assistant instructors may be employed to demonstrate the skill as it is explained.

Natural alignment is obtained by:

1. adopting the standing position;
2. acquiring a sight picture;
3. closing both eyes;
4. taking 3–4 normal breaths to relax the muscles;
5. after 10 seconds, opening the eyes to inspect the sight picture; and
6. adjusting body position to acquire a sight picture.



The purpose of closing the eyes and relaxing is to allow the muscles to return to a natural position. This allows the position to be adjusted and avoids having to force the cadet air rifle to aim at the target.

CONFIRMATION OF TEACHING POINT 4

QUESTIONS

- Q1. Natural alignment has a marksman in what type of position?
- Q2. How long are the eyes closed, and how many breaths are taken to obtain natural alignment?
- Q3. What negative effect can forcing the cadet air rifle have?

ANTICIPATED ANSWERS

- A1. In a comfortable standing position with the cadet air rifle at the ready.

A2. The eyes are closed for 10 seconds and 3–4 natural breaths are taken.

A3. It can cause muscle tension and will affect the accuracy of each shot.

Teaching Point 5**Have the Cadets Adopt the Standing Position**

Time: 30 min

Method: Practical Activity

ACTIVITY

OBJECTIVE

The objective of this activity is to have cadets adopt the standing position, position the cadet air rifle into the shoulder, obtain natural alignment and adjust their position as required.

RESOURCES

- Cadet air rifle (one per firing lane),
- Rifle rest (one per firing lane),
- Target frame (one per firing lane),
- Suitable target (one per firing lane),
- Raised target platform (one per firing lane),
- Safety glasses/goggles.

ACTIVITY LAYOUT

Construct an air rifle range IAW Part 1, Section 8 of A-CR-CCP-177/PT-001.

ACTIVITY INSTRUCTIONS

1. Divide cadets into equal relays according to the number of firing lanes.
2. Have the relays take turns assuming the standing position using the cadet air rifle.
3. With assistance, allow the cadets to practice the standing position as taught.
4. Have cadets adjust their standing position, to include:
 - a. the body should face 90 degrees to the target;
 - b. the feet should be:
 - (1) positioned shoulder width apart,
 - (2) pointed straight ahead in relation to the body, or
 - (3) turned slightly outward for comfort,
 - c. the legs should be straight with knees unlocked;
 - d. the hips should be 90 degrees to the target and not thrust forward;
 - e. the back should be bent rearward;

- f. the left arm should rest against the ribcage with the elbow under the rifle, resting against the ribcage or hipbone;
 - g. the left hand supporting the rifle, should be positioned on the pump handle;
 - h. the right arm should drop naturally to the side with the right hand placed on the small of the butt;
 - i. the head should remain upright and in a natural position to allow the eyes to look through the sights; and
 - j. the butt should rest slightly high on the shoulder, allowing the cadet air rifle to rest naturally across the chest with the cheek resting on the stock and the sights at eye level.
5. Inspect each cadet for a comfortable position.
 6. Repeat steps as required, within the allotted time.

SAFETY

Ensure that the cadet air rifles are pointed in a safe direction at all times. Cadets will treat air rifles as though they are loaded.

CONFIRMATION OF TEACHING POINT 5

The cadets' participation in the standing position activity will serve as the confirmation of this TP.

END OF LESSON CONFIRMATION

The cadets' participation in the activity in TP 5 will serve as the confirmation of this lesson.

CONCLUSION

HOMEWORK/READING/PRACTICE

N/A.

METHOD OF EVALUATION

N/A.

CLOSING STATEMENT

The standing position is the least stable position due to its high centre of gravity and small support area. It requires a great amount of concentration and practice. The standing position is seen as a progression for cadet recreational marksmanship and is the only position for the international air rifle competitions.

INSTRUCTOR NOTES/REMARKS

Cadets who have completed this lesson will participate in EO M306.01 (Participate in a Recreational Marksmanship Activity, Section 1) from the standing position.

REFERENCES

A0-027 A-CR-CCP-177/PT-001 Director Cadets 3. (2001). *Canadian Cadet Movement: Cadet Marksmanship Program Reference Manual*. Ottawa, ON: Department of National Defence.

C2-146 (ISBN 0-9655780-0-3) Pullum, B. & Hanenkrat, F. (1997). *The New Position Rifle Shooting: A Comprehensive Guide to Better Target Shooting*. Oak Harbor, OH: Target Sports Education Center.

CLASSIFICATION ACTIVITY

CLASSIFICATION ACTIVITY

Objective. To provide cadets the opportunity to obtain marksmanship classifications.

Scoring. The standard for the classification levels that are:

1. Marksman: Two five-round groupings within a circle of 3 cm in diameter.
2. First Class Marksman: Two five-round groupings within a circle of 2.5 cm in diameter.
3. Expert Marksman: Two five-round groupings within a circle of 2 cm in diameter.
4. Distinguished Marksman: Two five-round groupings within a circle of 1.5 cm in diameter.

Equipment Required

Mandatory:

- CCT200GRTD Canadian Cadet Movement (CCM) Air Rifle Grouping Target (one per cadet),
- Air Rifle Grouping Template from A-CR-CCP-177/PT-001 (p. B1-1), and
- A stopwatch.

Optional aids to firing are limited to the following:

- Cadet air rifle sling,
- Marksmanship jacket,
- Shooting glove, and
- Hat.

Activity Instructions

1. Distribute an Air Rifle Grouping Target to each cadet.
2. Have the cadets write their name and date on the target and attach it to the target frame.
3. Give the cadets five pellets to fire into the centre of the target.
4. Have the cadets fire in relays following the commands given by the RSO.
5. Give the cadets 15 minutes to complete firing.
6. Have the cadets retrieve their targets.
7. Score the targets using the Air Rifle Grouping Template.
8. Record the scores and allow the cadets to keep their targets.

The following is prohibited:

- Alterations made to the rifles.
- A pellet-loading clip.
- Supports used as a rest for the rifle or the forearm.
- A spotting scope.
- Use of sights not provided with the cadet air rifle.
- Coaching.

THIS PAGE INTENTIONALLY LEFT BLANK

FUN ACTIVITIES – PYRAMID

PYRAMID
Objective. To fire pellets into each point on the pyramid.
Scoring. One point is awarded for each point on the pyramid that is hit by a pellet.
Equipment Required Mandatory: Pyramid Target (one per cadet). Optional aids to firing are limited to the following: <ul style="list-style-type: none">• Cadet air rifle sling,• Marksmanship jacket,• Shooting glove, and• Hat.
Activity Instructions <ol style="list-style-type: none">1. Distribute one Pyramid Target to each cadet.2. Have the cadets write their name and date on the target and attach it to the target frame.3. Give the cadets three pellets to fire, one pellet into each corner of the pyramid.4. Have the cadets fire in relays following the commands given by the RSO.5. Give the cadets three minutes to complete firing.6. Score the targets awarding one point for each corner hit on the pyramid.7. Allow the cadets to review and keep their targets. The following actions are prohibited: <ul style="list-style-type: none">• Alterations made to the rifles.• A pellet-loading clip.• Supports used as a rest for the rifle or the forearm.• A spotting scope.• Use of sights not provided with the cadet air rifle.

PYRAMID TARGET

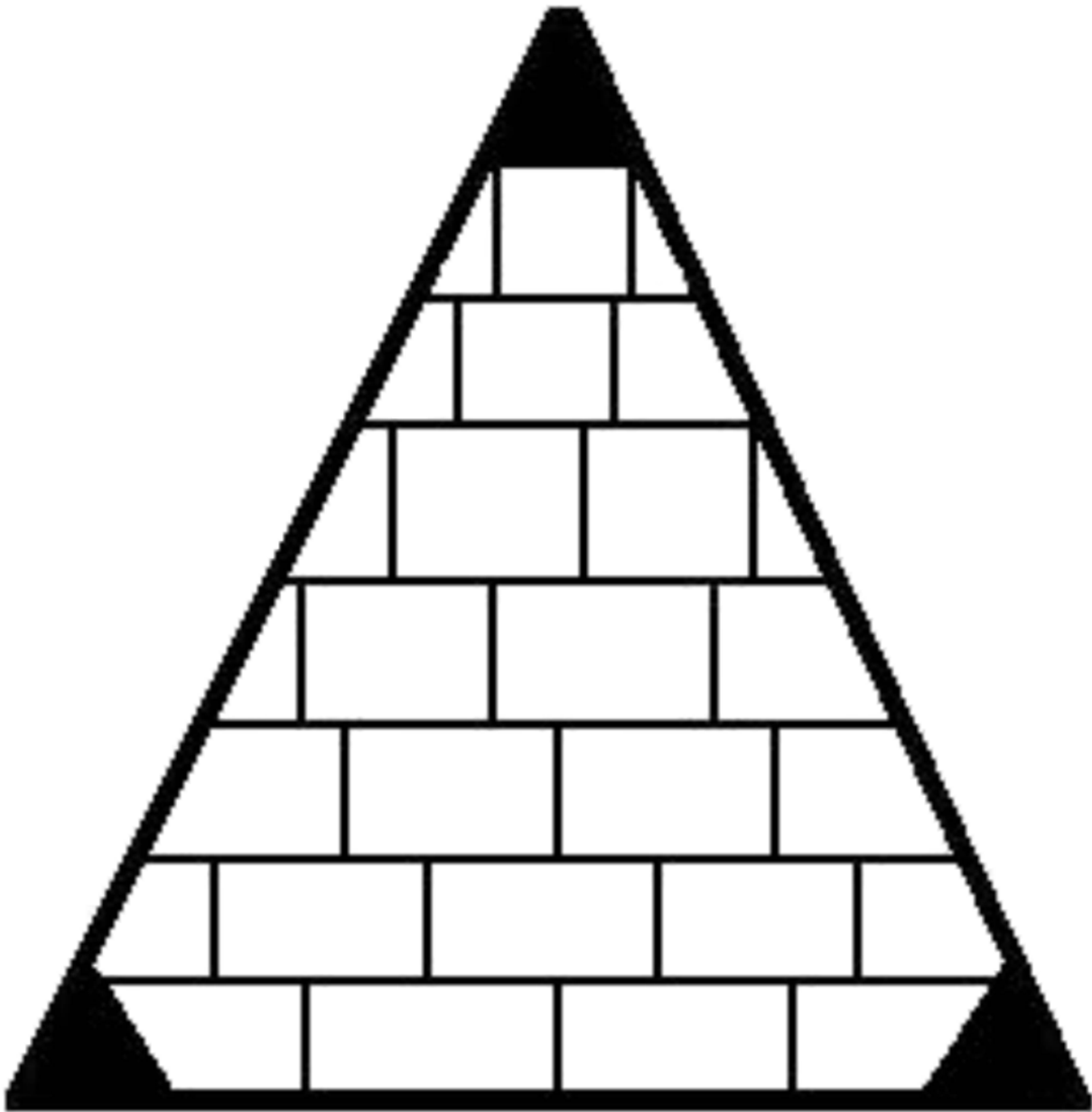

Name: _____ Date: _____

Director Cadets 3, 2007, Ottawa, ON: Department of National Defence

Figure 6B-1 Pyramid Target

FUN ACTIVITIES – SHOOTING STAR

SHOOTING STAR
Objective. To fire a pellet into each point on the star.
Scoring. One point is awarded for each point on the star that is hit by a pellet.
Equipment Required Mandatory: Star Target (one per cadet). Optional aids to firing are limited to the following: <ul style="list-style-type: none">• Cadet air rifle sling,• Marksmanship jacket,• Shooting glove, and• Hat.
Activity Instructions <ol style="list-style-type: none">1. Distribute one Star Target to each cadet.2. Have the cadets write their name and date on the target and attach it to the target frame.3. Give the cadets five pellets to fire, one pellet into each point on the star.4. Have the cadets fire in relays following the commands given by the RSO.5. Give the cadets five minutes to complete firing.6. Score the targets awarding one point for a pellet hit within each point on the star.7. Allow the cadets to review and keep their targets. The following is prohibited: <ul style="list-style-type: none">• Alterations made to the rifles.• A pellet-loading clip.• Supports used as a rest for the rifle or the forearm.• A spotting scope.• Use of sights not provided with the cadet air rifle.

STAR TARGET

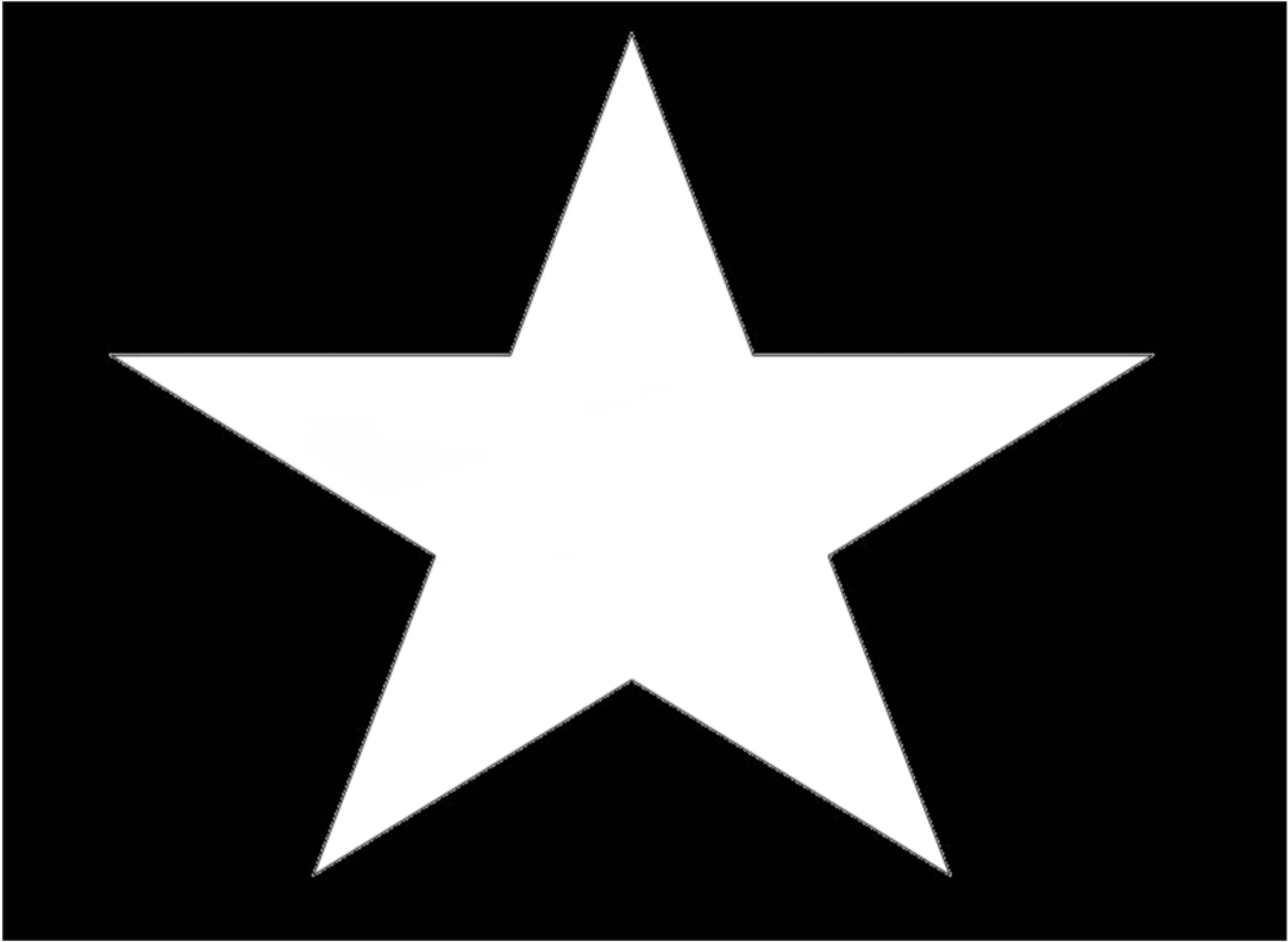

Name: _____ Date: _____

Director Cadets 3, 2007, Ottawa, ON: Department of National Defence

Figure 6C-1 Star Target

FUN ACTIVITIES – BEACH BALL

BEACH BALL
Objective. To fire 10 pellets into the black circle on the beach ball.
Scoring. One point is awarded for each successful hit in the black circle.
Equipment Required Mandatory: Beach Ball Target (one per cadet). Optional aids to firing are limited to the following: <ul style="list-style-type: none">• Cadet air rifle sling,• Marksmanship jacket,• Shooting glove, and• Hat.
Activity Instructions <ol style="list-style-type: none">1. Distribute one Beach Ball Target to each cadet.2. Have the cadets write their name and date on the target and attach it to the target frame.3. Give the cadets 10 pellets to fire into the black circle of the beach ball.4. Have the cadets fire in relays following the commands given by the RSO.5. Give the cadets 10 minutes to complete firing.6. Score the targets awarding one point for each pellet hit within the black circle.7. Allow the cadets to review and keep their targets. The following is prohibited: <ul style="list-style-type: none">• Alterations made to the rifles.• A pellet-loading clip.• Supports used as a rest for the rifle or the forearm.• A spotting scope.• Use of sights not provided with the cadet air rifle.

BEACH BALL TARGET



Name: _____ Date: _____

Director Cadets 3, 2006, Ottawa, ON: Department of National Defence

Figure 6D-1 Beach Ball Target

FUN ACTIVITIES – BALLOONS

BALLOONS	
Objective.	To fire pellets into balloons on the target.
Scoring.	One point is awarded for each balloon hit by a pellet.
Equipment Required	<p>Mandatory: Balloon Target (one per cadet).</p> <p>Optional aids to firing are limited to the following:</p> <ul style="list-style-type: none">• Cadet air rifle sling,• Marksmanship jacket,• Shooting glove, and• Hat.
Activity Instructions	<ol style="list-style-type: none">1. Distribute one Balloon Target to each cadet.2. Have the cadets write their name and date on the target and attach it to the target frame.3. Give the cadets five pellets to fire, one pellet into each balloon.4. Have the cadets fire in relays following the commands given by the RSO.5. Give the cadets five minutes to complete firing.6. Score the targets awarding one point for each balloon hit.7. Allow the cadets to review and keep their targets. <p>The following is prohibited:</p> <ul style="list-style-type: none">• Alterations made to the rifles.• A pellet-loading clip.• Supports used as a rest for the rifle or the forearm.• A spotting scope.• Use of sights not provided with the cadet air rifle.
Note:	Actual balloons may be used in place of the paper targets.

BALLOON TARGET

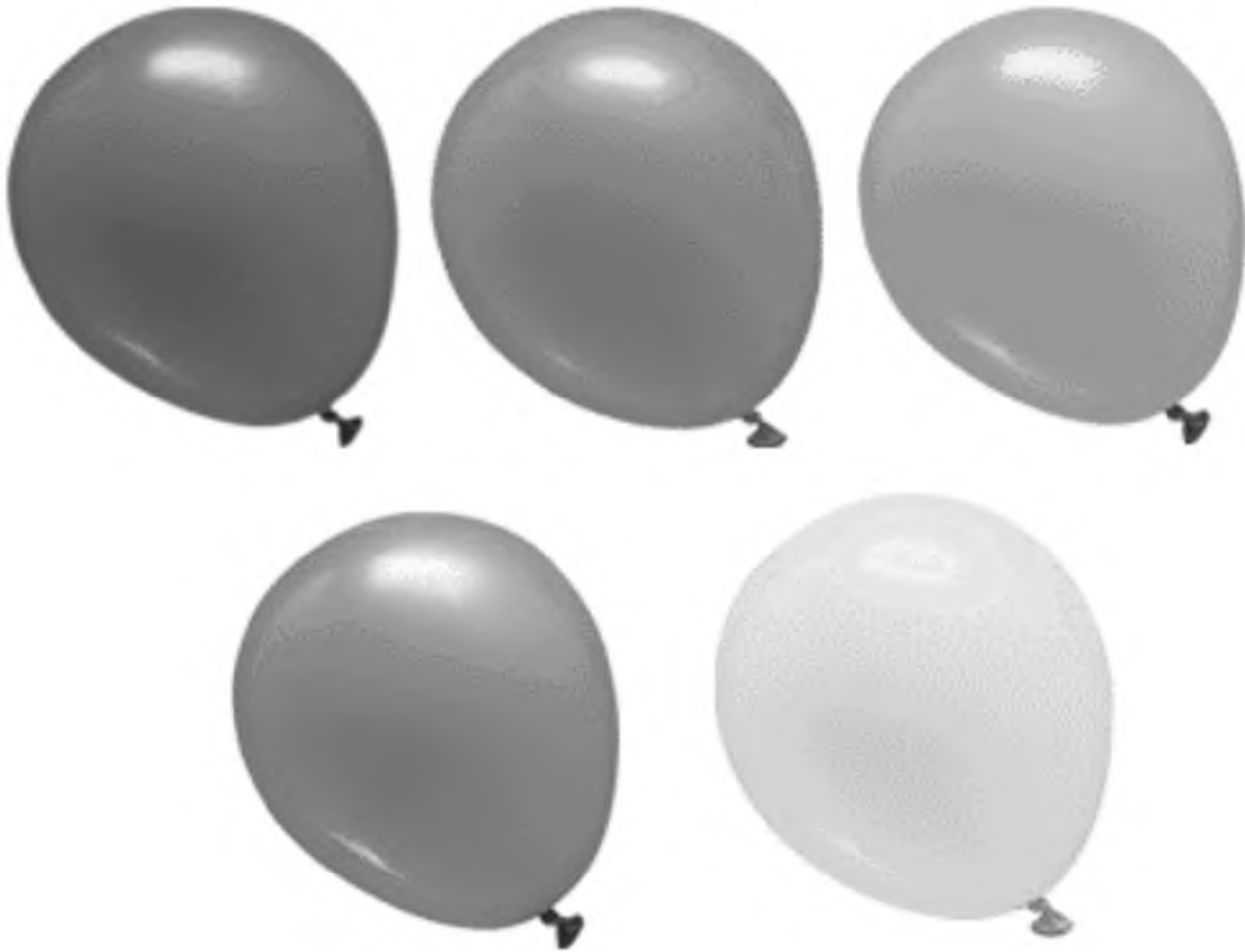

Name: _____ Date: _____

Director Cadets 3, 2007, Ottawa, ON: Department of National Defence

Figure 6E-1 Balloon Target

TIMED ACTIVITIES – CHASE THE DOTS

CHASE THE DOTS

Objective. To fire pellets into the dots on the target in a clockwise direction, within a time limit.

Scoring. One point is awarded for each black dot that is hit by a pellet within the time allotted.

Equipment Required

Mandatory:

- Chase the Dots Target (one per cadet), and
- A stopwatch.

Optional aids to firing are limited to the following:

- Cadet air rifle sling,
- Marksmanship jacket,
- Shooting glove, and
- Hat.

Activity Instructions

1. Distribute one Chase the Dots Target to each cadet.
2. Have the cadets write their name and date on the target and attach it to the target frame.
3. Give the cadets eight pellets to fire, one pellet into each black dot, in a clockwise direction.
4. Have the cadets fire in relays following the commands given by the RSO.
5. Give the cadets eight minutes to complete firing.
6. Score the targets awarding one point for each black dot hit.
7. Allow the cadets to review and keep their targets.

The following is prohibited:

- Alterations made to the rifles.
- A pellet-loading clip.
- Supports used as a rest for the rifle or the forearm.
- A spotting scope.
- Use of sights not provided with the cadet air rifle.
- Coaching.

Note: To make this activity more difficult, shorten the time allowance.

CHASE THE DOTS TARGET

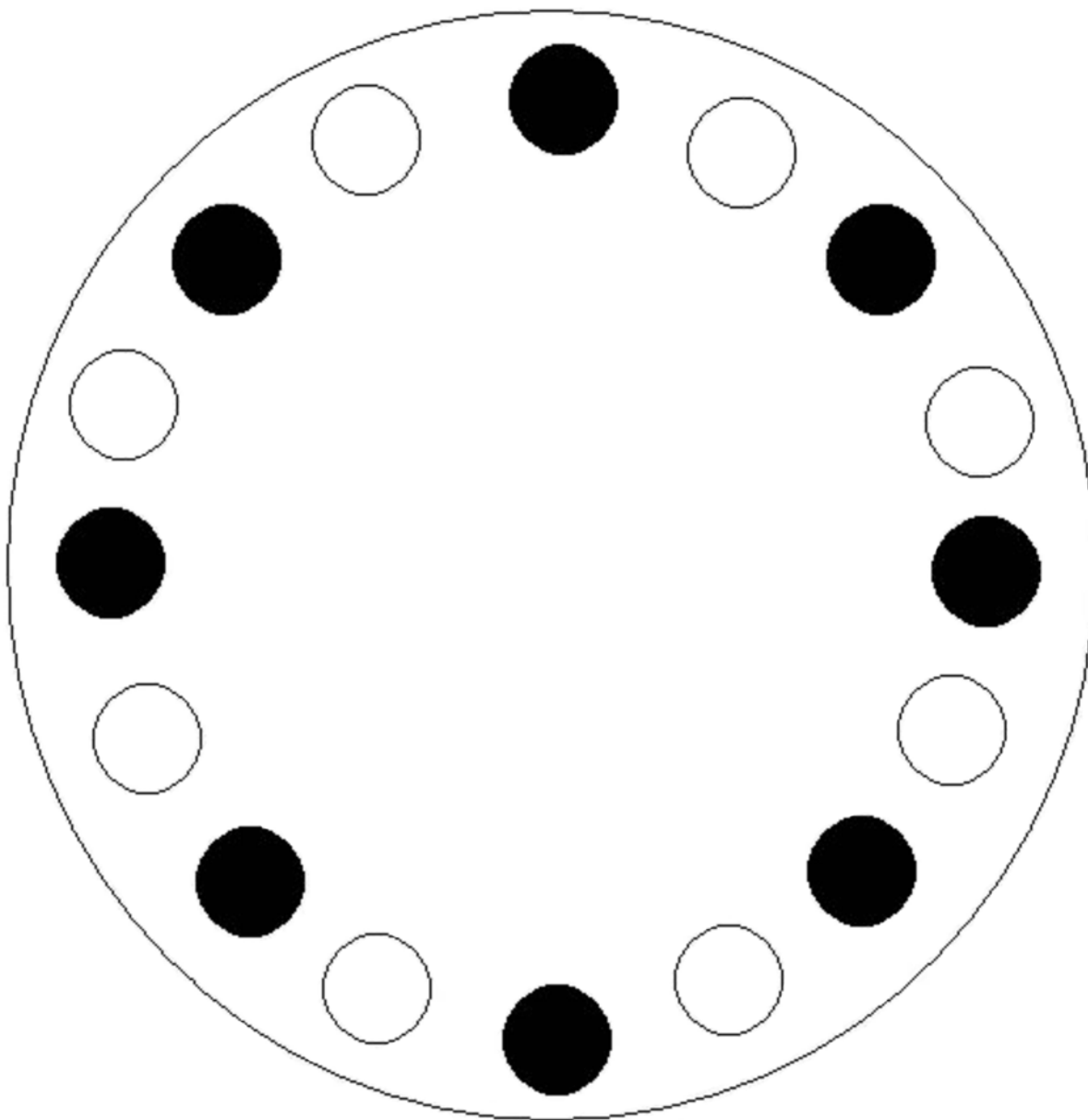

Name: _____ Date: _____

Director Cadets 3, 2007, Ottawa, ON: Department of National Defence

Figure 6F-1 Chase the Dots Target

TIMED ACTIVITIES – SPEED GRID

SPEED GRID	
Objective.	To fire pellets into the circles on the target, within a time limit.
Scoring.	One point is awarded for each circle that is hit by a pellet within the time allotted.
Equipment Required	
Mandatory:	
	<ul style="list-style-type: none">• Cadet air rifle five-pellet clip (three per firing lane),• Speed Grid Target (one per cadet), and• A stopwatch.
Optional aids to firing are limited to the following:	
	<ul style="list-style-type: none">• Cadet air rifle sling,• Marksmanship jacket,• Shooting glove, and• Hat.
Activity Instructions	
	<ol style="list-style-type: none">1. Distribute one Speed Grid Target to each cadet.2. Have the cadets write their name and date on the target and attach it to the target frame.3. Give the cadets 15 pellets, pre-loaded into three five pellet clips.4. Have the cadets fire one pellet into each circle on the target.5. Have the cadets fire in relays following the commands given by the RSO.6. Give the cadets 15 minutes to complete firing.7. Score the targets awarding one point for each circle hit.8. Allow the cadets to review and keep their targets.
The following is prohibited:	
	<ul style="list-style-type: none">• Alterations made to the rifles.• Supports used as a rest for the rifle or the forearm.• A spotting scope.• Use of sights not provided with the cadet air rifle.• Coaching.
Note:	To make this activity more difficult, shorten the time allowance.

SPEED GRID TARGET

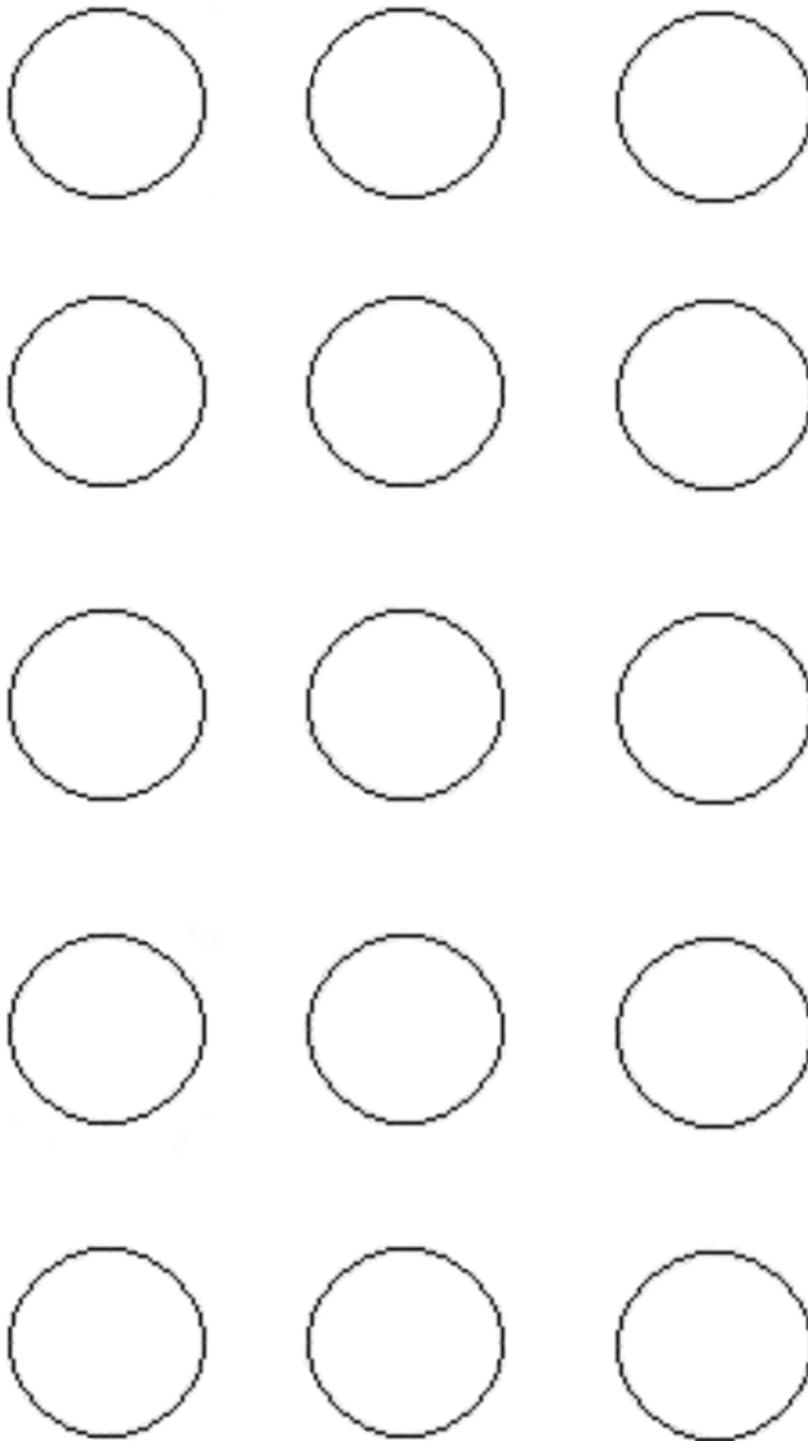

Name: _____ Date: _____

Director Cadets 3, 2007, Ottawa, ON: Department of National Defence

Figure 6G-1 Speed Grid Target

TIMED ACTIVITIES – BEAT THE CLOCK

BEAT THE CLOCK	
Objective.	To fire pellets into the designated hours (numbers) within a time limit.
Scoring.	One point is awarded for each correct hour (number) hit by a pellet within the time allotted.
Equipment Required	
Mandatory:	
<ul style="list-style-type: none">• Beat the Clock Target (one per cadet), and• A stopwatch.	
Optional aids to firing are limited to the following:	
<ul style="list-style-type: none">• Cadet air rifle sling,• Marksmanship jacket,• Shooting glove, and• Hat.	
Activity Instructions	
<ol style="list-style-type: none">1. Distribute one Beat the Clock Target to each cadet.2. Have the cadets write their name and date on the target and attach it to the target frame.3. Have the cadets fire in relays following the commands given by the RSO.4. Have the RSO using the 12-hour clock, call out one number every 20 second for a total of six numbers.5. Give the cadets six pellets to fire, one pellet at each hour (number) as it is called.6. Score the targets awarding one point for each correct number hit on the target.7. Allow the cadets to review and keep their targets.	
The following is prohibited:	
<ul style="list-style-type: none">• Alterations made to the rifles.• Supports used as a rest for the rifle or the forearm.• A spotting scope.• Use of sights not provided with the cadet air rifle.• Coaching.	
Note:	To make this activity more difficult, shorten the time allowance.

BEAT THE CLOCK TARGET

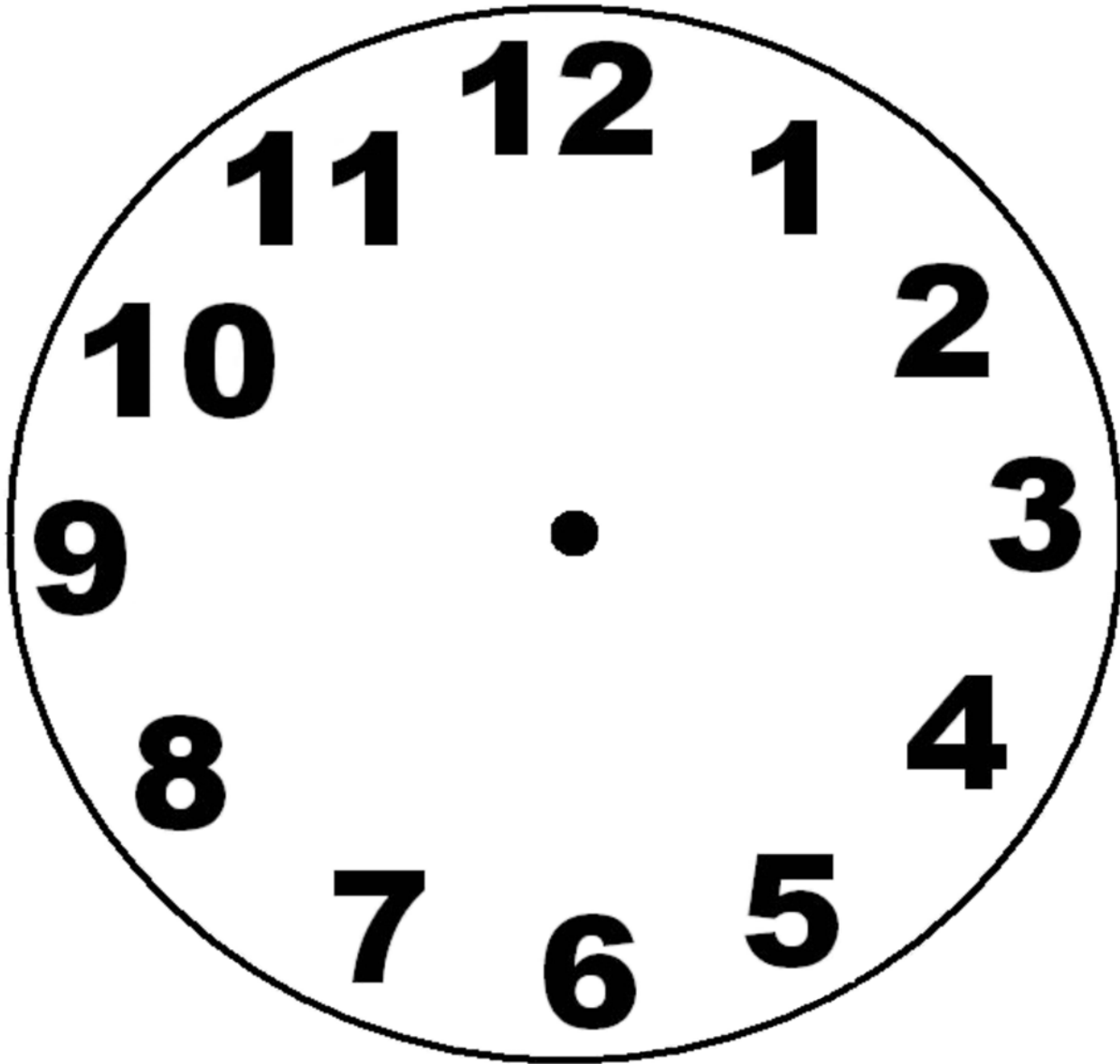

Name: _____ Date: _____

Director Cadets 3, 2007, Ottawa, ON: Department of National Defence

Figure 6H-1 Clock Target

COMPETITIVE ACTIVITIES – CORPS MARKSMANSHIP COMPETITION

CORPS MARKSMANSHIP COMPETITION
<p>Objective. To provide cadets the opportunity to compete within the corps.</p>
<p>Scoring. Targets will be scored IAW A-CR-CCP-177/PT-001, to include:</p> <ul style="list-style-type: none">• Each target has a highest possible score of 100 points (10 diagrams worth 10 points each).• All shot holes are scored using the highest value of the scoring ring that it is broken.• Shots outside the scoring rings are given a value of zero.• If more than the one pellet is fired on a target, the shots with the highest value will be discarded until one shot remain on the target. Also, a two-point penalty will be deducted for each excess shot.• If more than one shot is fired at a scoring diagram, only the prescribed number of shots may be fired at the remaining diagrams [eg, if two shots were fired at the first diagram, one diagram on the target would remain blank (free of shots)]. If this occurs more than twice, a two-point penalty will be deducted for each excess shot.• This activity may be conducted as individuals or teams of four.
<p>Equipment Required</p> <p>Mandatory: CCT2001AR853 CCM Competition Targets (two per cadet).</p> <p>Optional aids to firing are limited to the following:</p> <ul style="list-style-type: none">• Cadet air rifle sling,• Marksmanship jacket,• Shooting glove, and• Hat.
<p>Activity Instructions</p> <ol style="list-style-type: none">1. Distribute two CCT2001AR853 CCM Competition Targets to each cadet.2. Have the cadets write their name and date on each target and attach them to the target frame.3. Give the cadets 20 scoring pellets to fire, one pellet at each scoring diagram (additional zeroing pellets are permitted).4. Have the cadets fire in relays, following the commands given by the RSO.5. Give the cadets 30 minutes to complete firing.6. Have the RSO collect the targets, score as described above and record the results.7. Allow the cadets to review and keep their targets. <p>The following is prohibited:</p> <ul style="list-style-type: none">• Crossfiring.• Alterations made to the rifles.• Supports used as a rest for the rifle or the forearm.• A spotting scope.• Use of sights not provided with the cadet air rifle.

THIS PAGE INTENTIONALLY LEFT BLANK

COMPETITIVE ACTIVITIES – LUNAR LAUNCH

LUNAR LAUNCH			
Objective. To provide cadets the opportunity to compete within the corps.			
Scoring. The average distance from the earth to the moon is 384 400 km. All targets from marksmanship activities conducted during marksmanship training will be added together to calculate a distance from earth and achieve a position on the space shuttle crew. The four scoring levels/positions must meet the following standards:			
1.	Mission Commander:	A score of 100 plus:	384 400 km from earth, lunar landing!
2.	Mission Specialist:	A score of 75 to 99:	288 300 km from earth.
3.	Chief Engineer:	A score of 50 to 74:	192 200 km from earth.
4.	Science Officer:	A score of 25 to 49:	96 100 km from earth, lunar launch!
Equipment Required			
Mandatory: Scores for all targets used in marksmanship activities during the training year.			
Activity Instructions			
1. Add the scores from the targets used by each cadet during the training year.			
2. Use the scoring method described above to assign the cadets levels/positions on the space shuttle crew.			
Notes:			
1. A record must be kept of each cadet's scores from all marksmanship activities.			
2. This activity may be conducted over multiple training years.			
3. The certificate found in this annex may be awarded to cadets who achieve levels/positions in this activity.			

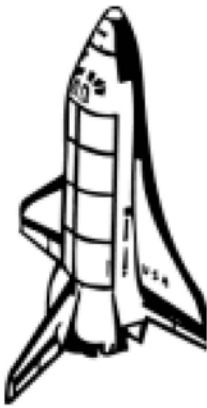

This is to certify that _____

has achieved the position of _____

in the



Lunar Launch Marksmanship Activity

_____ Date

_____ Range Safety Officer

MPI EXAMPLES

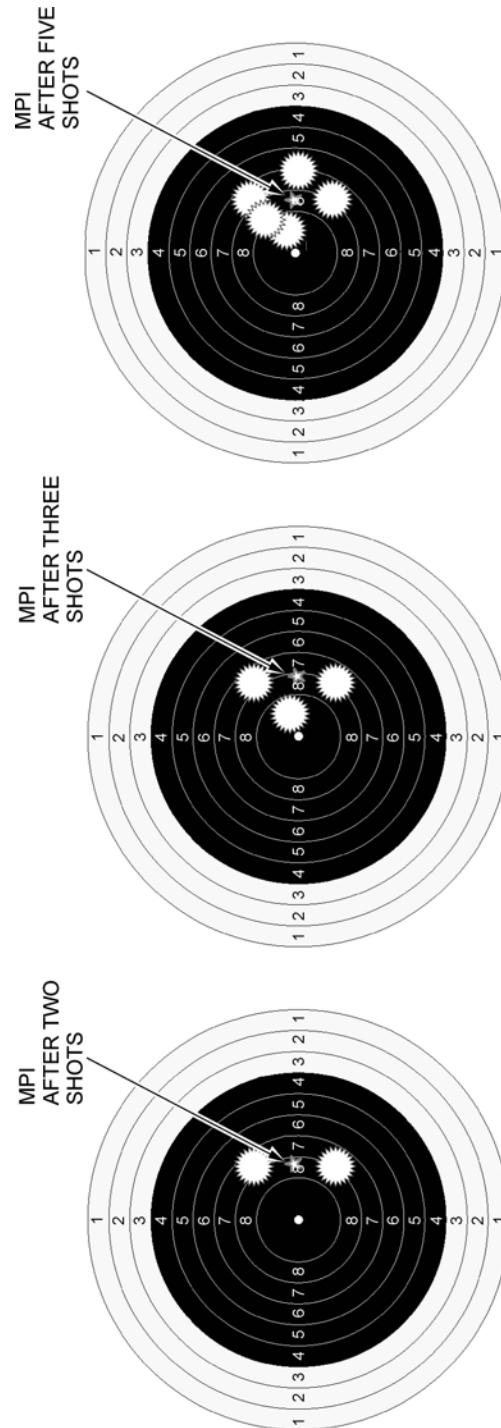

Director Cadets 3, 2007, Ottawa, ON: Department of National Defence

Figure 6K-1 MPI Examples

THIS PAGE INTENTIONALLY LEFT BLANK

SIGHT ADJUSTMENT ACTIVITY

Name: _____ Date: _____



ELEVATION: _____
WINDAGE: _____



ELEVATION: _____
WINDAGE: _____



ELEVATION: _____
WINDAGE: _____



ELEVATION: _____
WINDAGE: _____



ELEVATION: _____
WINDAGE: _____



ELEVATION: _____
WINDAGE: _____



ELEVATION: _____
WINDAGE: _____



ELEVATION: _____
WINDAGE: _____



ELEVATION: _____
WINDAGE: _____

Director Cadets 3, 2007, Ottawa, ON: Department of National Defence

Figure 6L-1 Sight Adjustment Activity Targets

THIS PAGE INTENTIONALLY LEFT BLANK

SIGHT ADJUSTMENT ACTIVITY ANSWER KEY



ELEVATION: 1 CCW
WINDAGE: 4 CCW



ELEVATION: 2 CCW
WINDAGE: 1 CW



ELEVATION: 5 CW
WINDAGE: 6 CCW



ELEVATION: 6 CW
WINDAGE: NONE



ELEVATION: 9 CW
WINDAGE: 12 CCW



ELEVATION: 6 CCW
WINDAGE: 1 CW



ELEVATION: 1 CCW
WINDAGE: 6 CCW



ELEVATION: 8 CCW
WINDAGE: 4 CCW



ELEVATION: 0 CLICKS
WINDAGE: 0 CLICKS

Director Cadets 3, 2007, Ottawa, ON: Department of National Defence

Figure 6M-1 Answer Key Targets

THIS PAGE INTENTIONALLY LEFT BLANK

CHAPTER 7

PO 307 – SERVE IN AN ARMY CADET CORPS



ROYAL CANADIAN ARMY CADETS

SILVER STAR

INSTRUCTIONAL GUIDE



SECTION 1

EO M307.01 – IDENTIFY SILVER STAR TRAINING OPPORTUNITIES

Total Time:

30 min

PREPARATION

PRE-LESSON INSTRUCTIONS

Resources needed for the delivery of this lesson are listed in the lesson specification located in A-CR-CCP-703/PG-001, Chapter 4. Specific uses for said resources are identified throughout the instructional guide within the TP for which they are required.

Review the lesson content and become familiar with the material prior to delivering the lesson.

Photocopy the summary of the POs and EOs for Silver Star training, located at A-CR-CCP-703/PG-001, Chapter 2, Annex A, for each cadet.

Obtain a copy of the corps Silver Star annual training plan.

Obtain a copy of the corps Full Value Contract developed during EO M107.01 (Participate in a Discussion on Year One Training, A-CR-CCP-701/PF-001, Chapter 7, Section 1).

PRE-LESSON ASSIGNMENT

N/A.

APPROACH

An interactive lecture was chosen for this lesson to orient the cadets to and generate interest in Silver Star training opportunities.

INTRODUCTION

REVIEW

N/A.

OBJECTIVES

By the end of this lesson the cadet shall have identified the training opportunities they will receive in Silver Star.

IMPORTANCE

It is important for cadets to receive an overview of the training that will be conducted during Silver Star as it may create eagerness and excitement to complete a year of new training experiences and leadership opportunities. The updates in the corps Full Value Contract should energize the cadets individually and as a group for the upcoming training year.

Teaching Point 1**Identify Silver Star Mandatory Training Opportunities**

Time: 5 min

Method: Interactive Lecture

Silver Star mandatory training is a plan of activities that corps, and specialized training establishments (expedition centres), must conduct for year three cadets. Mandatory training is conducted as follows:

1. sixty periods of instruction to be conducted during training sessions (3 periods per session);
2. eighteen periods of instruction to be conducted during two mandatory training days (9 periods per day);
3. eighteen periods of instruction to be conducted during one weekend bivouac Field Training Exercise (FTX); and
4. eighteen periods of instruction to be conducted during one weekend expedition exercise at an expedition centre.

TRAINING COMMON TO SEA, ARMY AND AIR CADETS

As in Green and Red Star, there is training in Silver Star which is common and applies to sea, army and air cadets. Performance objectives (POs) for common training this year include:

PO	Topic	PO Statement
301	Citizenship	Recognize the Purpose of Service Groups Within Canada
302	Community Service	Perform Community Service
303	Leadership	Perform the Role of a Team Leader
304	Personal Fitness and Healthy Living	Update Personal Activity Plan
305	Recreational Sports	Participate in Recreational Sports
306	Air Rifle Marksmanship	Fire the Cadet Air Rifle During Recreational Marksmanship
307	General Cadet Knowledge	Serve in an Army Cadet Corps
308	Drill	Direct a Squad Prior to a Parade
309	Instructional Techniques	Instruct a Lesson
311	Biathlon	(Complementary Only)



The Annual Ceremonial Review (ACR) is also common to all three elements of cadets, but there is no specific training allocated for it.

ARMY CADET ELEMENTAL TRAINING

There is training in Silver Star that is specifically designed for army cadets. POs for the army cadet specific training this year include:

PO	Topic	PO Statement
320	CF Familiarization	Recognize the Valour of Members of the Canadian Army
321	Field Training	Perform the Duties of a Team Leader on a Weekend Bivouac Exercise
322	Navigation	Plot Location on a Topographical Map Using a Global Positioning System Receiver
323	Trekking	(Complementary Only)
324	Wilderness Survival	Survive When Lost
325	Outdoor Leadership	Identify the Competencies of an Outdoor Leader
326	Expedition	Perform Expedition Skills

Expedition is one activity that distinguishes army cadets from the other cadet elements. Expedition is defined as any activity that consists of dynamic travel of no less than 36 hours in duration, where there is a clear goal associated with the activity. "In Silver Star training, expedition is supported by PO 321 (Perform the duties of a Team Leader on a Weekend Bivouac Exercise, Chapter 12), PO 322 (Plot Location on a Topographical Map Using a Global Positioning System Receiver, Chapter 13), PO 324 (Survive When Lost, Chapter 14), PO 325 (Identify the Competencies of Outdoor Leaders, Chapter 15) and PO 326 (Perform Expedition Skills, Chapter 16). In Silver Star cadets will have the opportunity to attend a weekend Expedition Exercise at a Regional Expedition Centre.

Assessment is an important aspect of cadet training. It is designed to assist cadets and their instructors meet the training targets set for each PO. Cadets will be informed of the requirements prior to assessment starting. After the assessment is completed, the cadet will be informed of their results and given a copy to keep. The POs and methods to be assessed include:

- 303 (Perform the Role of a Team Leader, Chapter 3). Performance assessment and personal communication.
- 308 (Direct a Squad Prior to a Parade, Chapter 8). Performance assessment.
- 309 (Instruct a Lesson, Chapter 9). Performance assessment.
- 322 (Plot Location on a Topographical Map Using a Global Positioning System Receiver, Chapter 13), to include:
 - EC-01 Extended written response, and
 - PC Performance assessment.
- 324 (Survive When Lost, Chapter 14), to include:
 - EC-01 Performance assessment,
 - EC-02 Performance assessment,
 - EC-03 Performance assessment, and
 - EC-04 Personal communication.
- 326 (Perform Expedition Skills, Chapter 16). Performance assessment.



The details for each assessment can be located at A-CR-CCP-703/PG-001, Chapter 3, Annex B.

CONFIRMATION OF TEACHING POINT 1

QUESTIONS

- Q1. How many mandatory periods of instruction are there?
- Q2. What is common training?
- Q3. Which POs support expedition training in Silver Star?

ANTICIPATED ANSWERS

- A1. There are 60 mandatory periods of instruction.
- A2. Common training is training that applies to sea, army and air cadets.
- A3. Expedition training in Silver Star is supported by PO 221 (Perform the Duties of a Section Member During a Weekend Bivouac Exercise, A-CR-CCP-702/PF-001, Chapter 11), PO 222 (Navigate Along a Route Using a Map and Compass, A-CR-CCP-702/PF-001, Chapter 12), PO 224 (Identify Immediate Actions to Take When Lost, A-CR-CCP-702/PF-001, Chapter 14), PO 325 (Identify the Competencies of Outdoor Leaders, Chapter 15) and PO 326 (Perform Expedition Skills, Chapter 16).

Teaching Point 2

Identify Silver Star Complementary Training Opportunities

Time: 5 min

Method: Interactive Lecture

Silver Star complementary training is a plan of activities that corps and specialized training establishments (expedition centres) may conduct for year three cadets. These activities complement mandatory activities and form an integral part of the Star Level program. Every PO identified in TP 1, except for PO 326 (Perform Expedition Skills, Chapter 16) has complementary activities available to be selected. Commanding Officers (COs) have the discretion to choose activities from a range of possibilities, thus allowing them flexibility to tailor Silver Star training to match the corps' interests and resources.



This TP will vary by cadet corps. Refer to the corps annual training plan and discuss the complementary training the cadet corps will conduct throughout the Silver Star program.

CONFIRMATION OF TEACHING POINT 2

QUESTIONS

- Q1. What complementary training is being conducted in Silver Star that is also available to sea and air cadets?
- Q2. What army cadet specific complementary training is being conducted in Silver Star?
- Q3. What complementary training is most interesting as a Silver Star cadet?

ANTICIPATED ANSWERS

- A1. Answers will only be from common POs.
- A2. Answers will vary.
- A3. Answers will vary.

Teaching Point 3

Review the Goals of a Full Value Contract (FVC)

Time: 15 min

Method: Interactive Lecture



A corps FVC was developed in EO M107.01 (Participate in a Discussion on Year One Training, A-CR-CCP-701/PF-001, Chapter 7, Section 1) and revisited in Red Star as a refresher of the FVC.

Review the elements of the corps' existing FVC. All cadets should be aware of the corps goals that were developed.

The cadets may agree that some goals need to be changed, added or even deleted.

GOALS OF THE FVC



A Full Value Contract can take many forms; examples are located at Annex A.

Before establishing a FVC, everyone must be ready to commit to common goals.

Be Here. The FVC asks everyone to make a conscious commitment to be present in body and mind, as well as to commit to full participation and to accept and demonstrate responsibility for their actions. This means that everyone shows interest in supporting others and actively engaging in the learning process.

Be Safe. In order to stimulate interest, facilitate participation and create an open-minded environment for the group members, everyone must feel safe. It is the instructor's responsibility to ensure that team members feel physically and emotionally safe in order to contribute to their learning process. This responsibility also falls on group members. Behaviours and attitudes must not put other group members at risk. A safe environment will encourage each member to actively participate, ask questions and give answers without fear of being ridiculed.

Set Goals. It is essential that everyone set personal goals. These goals provide the person and the group reference points to make choices about actions and plans. In every learning process, it is imperative to set goals. Once goals are set, group members and individuals will take on the responsibility to reach them. The FVC calls for the members of a group to work collectively toward the attainment of group goals and to support each other to meet individual goals.

Be Honest. Being honest assumes that one is honest with others and with oneself. For example, in a situation of disappointment or anger, the team members must simply acknowledge their feelings in regard to the situation and openly and fairly explain their state of mind. In this situation, everybody will be able to work toward solving the problem. Being honest requires members to be accountable to each other and responsible for their own actions and words.

Let Go and Move On. The FVC requires that group members acknowledge that they will not always agree and that they will have different opinions and ideas. In this instance, members must choose to put aside differences and move forward in order to achieve the goals.

CONFIRMATION OF TEACHING POINT 3

QUESTIONS

- Q1. What are the goals of the FVC?
- Q2. In the FVC, what does “be honest” imply?
- Q3. What must happen before letting go and moving on?

ANTICIPATED ANSWERS

- A1. The goals of the FVC are:
- be here,
 - be safe,
 - set goals,
 - be honest, and
 - let go and move on.
- A2. That everyone is honest with others and themselves.
- A3. Everyone must choose to put aside differences and move forward in order to achieve the goals.

END OF LESSON CONFIRMATION

QUESTIONS

- Q1. What POs are army cadet specific?
- Q2. Which PO in Silver Star has no complementary training?
- Q3. What changes have you noticed in the FVC over the years?

ANTICIPATED ANSWERS

- A1. The army cadet specific POs include:
- 320 (Recognize the Valour of Members of the Canadian Army, Chapter 11),
 - 321 (Perform the Duties of a Team Leader on a Weekend Bivouac Exercise, Chapter 12),
 - 322 (Plot Location on a Topographical Map Using a Global Positioning System Receiver, Chapter 13),
 - 323 (Trekking [complementary only]),
 - 324 (Survive When Lost, Chapter 14),
 - 325 (Identify the Competencies of an Outdoor Leader, Chapter 15), and

- 326 (Perform Expedition Skills, Chapter 16).
- A2. PO 326 (Perform Expedition Skills, Chapter 16).
- A3. Answers will vary.

CONCLUSION

HOMEWORK/READING/PRACTICE

N/A.

METHOD OF EVALUATION

N/A.

CLOSING STATEMENT

Knowing what to expect in the Silver Star program allows the cadets to have an understanding of the training ahead of them. It also aids in maintaining interest and anticipation of the emerging leadership challenges for a Silver Star cadet.

INSTRUCTOR NOTES/REMARKS

For Silver Star complementary training opportunities in TP 2, refer to the corps' annual training plan.

This EO should be scheduled as early as possible in the training year. A sample schedule is located in A-CR-CCP-703/PG-001, Chapter 2, Annex B.

REFERENCES

- A0-054 Director Cadets 3. (2007). CATO 11-04, *Cadet Program Outline*. Ottawa, ON: Department of National Defence.
- C2-038 (ISBN 0-7872-2459-6) Henton, M. (2006). *Adventure in the Classroom: Using Adventure to Strengthen Learning and Build a Community of Life-Long Learners*. Dubuque, IA: Kendall Hunt Publishing.

THIS PAGE INTENTIONALLY LEFT BLANK



ROYAL CANADIAN ARMY CADETS

SILVER STAR

INSTRUCTIONAL GUIDE



SECTION 2

EO M307.02 – IDENTIFY YEAR THREE CSTC TRAINING OPPORTUNITIES

Total Time:

30 min

PREPARATION

PRE-LESSON INSTRUCTIONS

Resources needed for the delivery of this lesson are listed in the lesson specification located in A-CR-CCP-703/PG-001, Chapter 4. Specific uses for said resources are identified throughout the instructional guide within the TP for which they are required.

Review the lesson content and become familiar with the material prior to delivering the lesson.

Refer to Annex C of CATO 40-01, *Army Cadet Program Outline* prior to delivering this lesson.

PRE-LESSON ASSIGNMENT

N/A.

APPROACH

A group discussion was chosen for TP 1 as it allows the cadets to interact with their peers and share their experiences, opinions, and feelings about areas of interest for CSTC training opportunities.

An interactive lecture was chosen for TP 2 to orient the cadets to year three CSTC training opportunities and generate interest.

INTRODUCTION

REVIEW

N/A.

OBJECTIVES

By the end of this lesson the cadet shall have identified year three CSTC training opportunities.

IMPORTANCE

It is important for cadets to identify the year three CSTC training opportunities available to them, as it will allow them to make an informed decision on which course they would like to apply for.

Teaching Point 1

Discuss the Areas of Interest for CSTC Training Opportunities

Time: 10 min

Method: Group Discussion

BACKGROUND KNOWLEDGE



The point of the group discussion is to draw the following information from the group using the tips for answering/facilitating discussion and the suggested questions provided.

Write the specialty areas on a whiteboard/flip chart and discuss the activities associated with each area. Cadets may already know which area they would like to pursue and may already have a general idea of the activities.

CEREMONIAL LEADERSHIP

Cadets will develop the knowledge and skills required to improve leadership abilities in a peer and small group setting. Topics include:

- leadership,
- confidence building,
- public speaking,
- problem solving, and
- ceremonial drill.

EXPEDITION LEADERSHIP

Cadets will develop expedition knowledge and skills in a field setting. Topics include:

- adventure training activities,
- field training,
- trekking,
- navigating,
- wilderness survival, and
- expedition.

FULLBORE MARKSMANSHIP

Cadets will develop the knowledge and skills required to improve fullbore marksmanship abilities. Topics include:

- marksmanship with fullbore rifles,
- recreational marksmanship, and
- course level marksmanship competition.

AIR RIFLE MARKSMANSHIP

Cadets will develop the knowledge and skills required to improve air rifle marksmanship abilities. Topics include:

- two-position shooting (standing and prone),
- recreational marksmanship,
- course level marksmanship competition, and
- biathlon.

FITNESS AND SPORTS

Cadets will improve individual fitness and sports knowledge and skills. Topics include:

- studying personal fitness;
- studying rules and regulations of sports; and
- organizing and delivering sports activities.

MILITARY BAND

Cadets will develop music knowledge and skills. Topics include:

- studying music theory;
- playing an instrument as part of an ensemble;
- playing an instrument as part of a military band; and
- developing individual music skills.

PIPE BAND

Cadets will develop music knowledge and skills. Topics include:

- studying music theory;
- playing an instrument as part of an ensemble;
- playing an instrument as part of a pipe and drum band; and
- developing individual music skills.

GROUP DISCUSSION



TIPS FOR ANSWERING/FACILITATING DISCUSSION

- Establish ground rules for discussion, eg, everyone should listen respectfully; don't interrupt; only one person speaks at a time; no one's ideas should be made fun of; you can disagree with ideas but not with the person; try to understand others as much as you hope they understand you; etc.
- Sit the group in a circle, making sure all cadets can be seen by everyone else.
- Ask questions that will provoke thought; in other words avoid questions with yes or no answers.
- Manage time by ensuring the cadets stay on topic.
- Listen and respond in a way that indicates you have heard and understood the cadet. This can be done by paraphrasing their ideas.
- Give the cadets time to respond to your questions.
- Ensure every cadet has an opportunity to participate. One option is to go around the group and have each cadet answer the question with a short answer. Cadets must also have the option to pass if they wish.
- Additional questions should be prepared ahead of time.

SUGGESTED QUESTIONS

- Q1. Which summer training activities interest you?
- Q2. Who is interested in applying for summer training this year? Why?
- Q3. What areas of interest do you plan to pursue? Why?



Other questions and answers will develop throughout the group discussion. The group discussion should not be limited to only those suggested.



Reinforce those answers given and comments made during the group discussion, ensuring the teaching point has been covered.

CONFIRMATION OF TEACHING POINT 1

The cadets participation in the group discussion will serve as the confirmation of this TP.

Teaching Point 2**Discuss Year Three CSTC Courses and the Prerequisites**

Time: 15 min

Method: Interactive Lecture



During this TP, a cadet who has successfully completed one of the year three courses could be asked to speak about their experience. This will give a cadet's view of the course and let the other cadets know what they could expect.

COMMON COURSES

The CSTC courses listed below are common and apply to sea, army and air cadets.



As the prerequisites for any CSTC course may change, refer to CATO 40-01, *Army Cadet Program Outline*.

Air Rifle Marksmanship Instructor. The aim of this course is to develop specialist knowledge and skills in air rifle marksmanship and biathlon. This will allow the cadet to assist in the development and implementation of a competitive marksmanship program and instruct marksmanship training in the corps program. The prerequisite for this six-week, regionally conducted course is the successful completion of the Silver Star program.

Fitness and Sports Instructor. The aim of this course is to improve individual fitness and develop the knowledge and skills needed to allow the cadet to assist in the organization and delivery of various sports activities. The prerequisites for this six-week, regionally conducted course are the successful completion of the Silver Star program, an intermediate fitness level and an interest in fitness and sports.

Intermediate Military Band Musician. The aim of this course is to expand on the knowledge and skills required to play and lead a unit military band. The prerequisites for this six-week, regionally conducted course are the successful completion of the Red Star program and Music Level Basic or 1.

Intermediate Pipe Band Musician. The aim of this course is to expand on the knowledge and skills required to play and lead a unit pipe band. The prerequisites for this six-week, regionally conducted course are the successful completion of the Red Star program and Music Level Basic or 1.

ARMY CADET ELEMENTAL COURSES

The CSTC courses listed below are specifically designed for army cadets.

Drill and Ceremonial Instructor. The aim of this course is to continue to develop leadership knowledge and skills required for junior leadership positions supporting the corps program. It also develops a specialty in drill and ceremonial, and drill instruction. The prerequisite for this six-week, regionally conducted course is the successful completion of the Silver Star program.

Expedition Instructor. The aim of this course is to develop subject matter knowledge and specialist skills required to successfully participate in, and lead during an intermediate level expedition. The prerequisites for this six-week course are the successful completion of the Silver Star program, ability to swim with the aid of a Personal Floatation Device (PFD) and a suitable medical category for strenuous field activities.

Fullbore Marksman Phase I. The aim of this course is to develop a specialist level of knowledge and skills in marksmanship beyond the air rifle. This will allow the cadet to participate as an individual or as a team member

in a national-level target rifle competition. The prerequisites for this six-week, nationally conducted course are the successful completion of the Silver Star program, the successful completion of the Basic Marksman course and demonstrated marksmanship ability.

CONFIRMATION OF TEACHING POINT 2

QUESTIONS

- Q1. What year three CSTC courses are common to army, air and sea cadets?
- Q2. What year three CSTC courses are only for army cadets?
- Q3. What year three CSTC courses interest you the most? Why?

ANTICIPATED ANSWERS

- A1. Year three CSTC common courses include:
- Air Rifle Marksmanship Instructor,
 - Fitness and Sports Instructor,
 - Intermediate Military Band Musician, and
 - Intermediate Pipe Band Musician.
- A2. Year three CSTC courses for army cadets only include:
- Drill and Ceremonial Instructor,
 - Expedition Instructor, and
 - Fullbore Marksman Phase I.
- A3. Answers will vary.

END OF LESSON CONFIRMATION

The cadets' participation in the group discussion will serve as the confirmation of this lesson.

CONCLUSION

HOMEWORK/READING/PRACTICE

N/A.

METHOD OF EVALUATION

N/A.

CLOSING STATEMENT

It is important for cadets to be familiar with the summer training courses offered, so they may apply for the courses that interest them the most. Training is offered in speciality areas that may not be accessible at the corps. Summer training is a fun and exciting aspect of the Cadet Program. CSTCs are also places to meet cadets and make new friends from different corps across Canada.

INSTRUCTOR NOTES/REMARKS

This EO should be conducted prior to the summer training application deadline.

It is recommended that the summer training application forms be completed during a training session after this EO has been conducted.

REFERENCES

- A0-010 Director Cadets 2. (2006). CATO 11-03, *Cadet Program Mandate*. Ottawa, ON: Department of National Defence.
- A0-033 Director Cadets 3. (2004). CATO 14-21, *Music Training and Education With the Canadian Cadet Organizations*. Ottawa, ON: Department of National Defence.
- A2-031 Director Cadets 3. (2008). CATO 40-01, *Army Cadet Program Outline*. Ottawa, ON: Department of National Defence.

THIS PAGE INTENTIONALLY LEFT BLANK



ROYAL CANADIAN ARMY CADETS

SILVER STAR

INSTRUCTIONAL GUIDE



SECTION 3

EO M307.03 – RECOGNIZE THE PARTNERSHIP BETWEEN THE ARMY CADET LEAGUE OF CANADA (ACLC) AND THE DEPARTMENT OF NATIONAL DEFENCE (DND)

Total Time: 30 min

PREPARATION

PRE-LESSON INSTRUCTIONS

Resources needed for the delivery of this lesson are listed in the lesson specification located in A-CR-CCP-703/PG-001, Specific uses for said resources are identified throughout the instructional guide within the TP for which they are required.

Review the lesson content and become familiar with the material prior to delivering the lesson.

PRE-LESSON ASSIGNMENT

N/A.

APPROACH

An interactive lecture was chosen for this lesson to introduce cadets to the three levels of the ACLC and the responsibilities of the ACLC and DND in support of the CCM, as it allows the instructor to control the delivery of information while encouraging the cadets to become actively involved by asking and responding to questions.

INTRODUCTION

REVIEW

N/A.

OBJECTIVES

By the end of this lesson the cadet shall recognize the partnership between the ACLC and DND in support of the CCM.

IMPORTANCE

It is important for cadets to recognize the partnership between the ACLC and DND in support of the CCM because these two organizations work together to ensure the success of the CCM which impacts the cadet directly. Some cadets will not be aware that there are many people and organizations supporting the program beyond the local corps.

Teaching Point 1**Describe the Three Levels of the ACLC**

Time: 5 min

Method: Interactive Lecture

There are three branches of the Army Cadet League of Canada (ACLC). Each one works in partnership with DND on respective matters.

National

Located in Ottawa, Ontario and overseen by an Executive Director, the national office is responsible for managing the day-to-day affairs of the ACLC.

The national office administers and coordinates all National League activities including insurance, finances and honours and awards.

Provincial/Territorial

The provincial branch of the ACLC oversees the local representatives and administers volunteer screening and fundraising within the province/territory. In addition, the provincial/territorial branch submits applications on behalf of the province for national awards.

Local Sponsor

There are many local sponsors who make up the ACLC. Volunteers from the local sponsoring committees assist cadet corps with fundraising and activities.

There is often a representative of the local sponsor of the ACLC at parades and events including the Annual Ceremonial Review each year.

CONFIRMATION OF TEACHING POINT 1

QUESTIONS

- Q1. What are the three levels of the ACLC?
- Q2. Where would a representative of the ACLC visiting a cadet corps typically come from?
- Q3. What level of the ACLC administers awards?

ANTICIPATED ANSWERS

- A1. The three levels of the ACLC are:
- national,
 - provincial/territorial, and
 - local sponsor.
- A2. The local sponsor.
- A3. National level.

Teaching Point 2**Identify the Responsibilities of the ACLC and DND**

Time: 10 min

Method: Interactive Lecture

RESPONSIBILITIES OF THE ACLC

Recruiting Cadets. The local sponsor must organize and implement a plan for recruiting cadets.

Recruiting Cadet Instructor Cadre (CIC) Officers. The ACLC is responsible for recommending suitable people to be enrolled into the Canadian Forces (CF) as cadet instructors.

Fundraising. The local sponsor must organize fundraising activities that support the corps.

Providing Corps Training Facilities. The ACLC provincial branches provide office and training facilities for the corps, when not provided by DND.

Organizing/Conducting Recreational Programs. The ACLC is responsible for organizing and conducting various activities where the corps requires assistance.

Providing Funds for Optional Training Activities. The ACLC local sponsor and provincial branch provide funds for optional training activities which DND does not support.

Providing Equipment to Cadet Corps. The ACLC is responsible for providing equipment to support optional training activities.

RESPONSIBILITIES OF DND

Training CIC Officers. DND is responsible for analyzing, designing and developing course curriculum, approving training according to regional requirements and consulting with the ACLC with respect to CIC officer course content.

Providing Qualification Standards and Plans (QSPs) and Instructional Guides (IGs) for Cadet Training. DND develops and provides QSPs and IGs that direct cadet training.

Providing Funds for Mandatory Training and Support Activities. Mandatory training and support activities that are approved are funded by DND.

Developing Policy Regarding CIC Officers, Civilian Instructors (CIs) and Cadets. DND is responsible for developing, implementing and enforcing policy regarding CIC officers, CIs and cadets.

Issuing Equipment to Cadet Corps IAW Scales of Issue. All equipment required for mandatory training, mandatory support activities and directed optional training is provided by DND.

Providing Pay for CIC Officers and CIs. DND is responsible for developing, implementing and enforcing pay policy as well as providing pay for CIC officers and CIs.

Selecting Cadets for Cadet Summer Training Centres (CSTCs). DND is responsible for ensuring that cadets meet prerequisites and selecting cadets for summer training courses.

Providing Facilities and Staff for CSTCs. DND is responsible for ensuring adequate facilities and selecting staff for CSTCs.

RESPONSIBILITIES OF BOTH THE ACLC AND DND

Forming or Disbanding Cadet Corps. The ACLC and DND work collaboratively to form new cadet corps and disband non-effective cadet corps.

Providing Awards and Medals. The ACLC and DND provide awards to cadets such as the General Walsh Memorial Sword, Cadet Certificate of Commendation and the Major-General W.A. Howard Award.

Developing Community and Media Relationships. Media relationships are maintained at all levels of the ACLC and DND. DND has regionally and nationally appointed public affairs officers that maintain media relationships at their level. It is the responsibility of the local ACLC sponsor to ensure good relations with the local community and media.

Supervising and Administering Cadet Corps. The local ACLC sponsor and corps' staff work collaboratively to ensure there is adequate supervision and administration within the cadet corps.

Providing a Reviewing Party for Annual Ceremonial Reviews (ACRs). The ACLC and DND work collaboratively to provide reviewing parties for corps' ACRs.

CONFIRMATION OF TEACHING POINT 2

QUESTIONS

- Q1. What are the responsibilities of the ACLC?
- Q2. What are the responsibilities of DND?
- Q3. What is one responsibility of both the ACLC and DND?

ANTICIPATED ANSWERS

- A1. The ACLC is responsible for:
- recruiting cadets;
 - recruiting CIC officers;
 - fundraising;
 - providing corps training facilities;
 - organizing/conducting recreational programs;
 - providing funds for optional training activities; and
 - providing equipment to cadet corps.
- A2. DND is responsible for:
- training CIC officers;
 - providing QSPs and IGs for cadet training;
 - providing funds for mandatory training and support activities;
 - developing policy regarding CIC officers, CIs and cadets;
 - issuing equipment to cadet corps IAW scales of issue;
 - providing pay for CIC officers and CIs;
 - selecting cadets for CSTCs; and
 - providing facilities and staff for CSTCs.

- A3. Both the ACLC and DND are responsible for:
- forming or disbanding cadet corps;
 - providing awards and medals;
 - developing community and media relationships;
 - supervising and administering cadet corps; and
 - providing a reviewing party for ACRs.

Teaching Point 3

Identify the Awards and Medals of the Army Cadet Program

Time: 10 min

Method: Interactive Lecture



CATO 13-16, *National Cadet Honours and Awards*, outlines the authority for all national awards including dress instructions.



The National Cadet Honours and Awards are not part of the Canadian Military Honours (orders, decorations and medals) system.



Selection of awards is a partnership between the cadet corps, RCSU and an ACLC representative.

General Walsh Memorial Sword. This award was created in 2004 by the ACLC in partnership with the Royal Canadian Legion. It is a national award and the highest national award for army cadets. The successful cadet will be hosted by the Royal Canadian Legion during Remembrance Day ceremonies and be a part of the vice-regal party. In addition to this, the cadet tours the national capital and meets both the Governor General, and the Chief of Defence Staff (CDS).

The award is named in honour of Lieutenant-General Geoffrey Walsh who dedicated much of his time to the Army Cadet Program.

Recipients are chosen based on their performance as army cadets, their community involvement and academic standings.

Cadet Medal of Bravery. The medal of bravery may be awarded to a cadet who performs an outstanding deed of valour involving risk of life in attempting to save the life or property of others.

Cadet Certificate of Commendation. The Cadet Certificate of Commendation may be awarded to a cadet for outstanding deeds in attempting to save the life or property of another person.

Lord Strathcona Medal. The Lord Strathcona Trust Fund Medal is given for exemplary performance in physical and military training. Lord Strathcona's objectives in establishing his endowment were:

- to encourage the improvement of the physical and intellectual capabilities of cadets; and
- to foster patriotism in cadets through the acquisition of good knowledge of military matters.

Legion Medal of Excellence. The Legion Medal of Excellence is given for demonstrating superior commitment to corps and community.

Army, Navy, and Air Force Veterans Medal (ANAVETS). The ANAVETS medal is given for overall achievement on the Cadet Leader Instructor’s course in the areas of leadership and physical fitness performance. Recipients of the ANAVETS medal are eligible to apply for the Colonel Frank Kossa Memorial Scholarship if perusing post secondary education.

Major-General W.A. Howard Award. This award promotes excellence in the final year of the star program in combination with a cadet’s overall performance. The award is administered and selected by a committee established within the ACLC.



Director Cadets 3, Royal Canadian Army Cadets Reference Book, Department of National Defence (p. 2-14)

Figure 7-3-1 Army Cadet Medals

Army Cadet Service Medal (ACSM). The ACSM is awarded to all nominated cadets who have completed four years of continuous meritorious service within the Army Cadet Program. Time spent within one element of the Cadet Program before a transfer to another element is counted toward the eligibility period of the Cadet Service Medal of any element. A cadet may only be awarded one service medal. The onus is on the cadet to apply for this award. The cadet cannot have any infractions and must be recommended by the corps Commanding Officer. All cadets, including former cadets can apply for the medal by completing the “Application for the Army Cadet Service Medal”.

1st Canadian Parachute Battalion Bursary. Awarded to a cadet with high academic standing and a graduate of the Army Cadet Parachutist Course.



Detailed prerequisites and nomination information can be found through the regional orders, and the ACLC Reference Manual at <http://www.armycadetleague.ca/Templates/refManual.htm>.

CONFIRMATION OF TEACHING POINT 3

QUESTIONS

Q1. What is the highest national award for army cadets?

- Q2. When is the Cadet Medal of Bravery Awarded?
- Q3. What is the Legion Medal of Excellence awarded for?

ANTICIPATED ANSWERS

- A1. The highest national award for army cadets is the General Walsh Memorial Sword.
- A2. The Cadet Medal of Bravery is awarded when a cadet performs an outstanding deed of valour involving risk of life in attempting to save the life or property of others.
- A3. The Legion Medal of Excellence is awarded for demonstrating superior commitment to corps and community.

END OF LESSON CONFIRMATION

QUESTIONS

- Q1. What does the provincial level of the ACLC do?
- Q2. What are the responsibilities of both the ACLC and DND?
- Q3. What is the ANAVETS medal awarded for?

ANTICIPATED ANSWERS

- A1. The provincial branch of the ACLC oversees the local representatives and administers volunteer screening and fundraising within the province/territory. In addition, the provincial/territorial branch submits applications on behalf of the province for national awards.
- A2. Both the ACLC and DND are responsible for:
- forming or disbanding cadet corps;
 - providing awards and medals;
 - developing community and media relationships;
 - supervising and administering cadet corps; and
 - providing reviewing parties for ACRs.
- A3. The ANAVETS cadet medal of merit is given for overall achievement on the Cadet Leader Instructor's course in the areas of leadership and physical fitness performance.

CONCLUSION

HOMEWORK/READING/PRACTICE

N/A.

METHOD OF EVALUATION

N/A.

CLOSING STATEMENT

Recognizing the partnership between the ACLC and DND in support of the CCM is important because these organizations work together to ensure the success of the CCM.

INSTRUCTOR NOTES/REMARKS

It is recommended that this EO be scheduled early in the training year.

This EO could be delivered by the local league representative or sponsoring committee representative.

REFERENCES

- A2-036 Director Cadets 3. (2003). *Royal Canadian Army Cadets Reference Book*. Ottawa, ON: Department of National Defence.
- A2-065 Director Cadets and Junior Canadian Rangers. (2005). *Memorandum of Understanding Between DND and the Leagues*. Ottawa, ON: Department of National Defence.
- C2-165 Army Cadet League of Canada. (2008). *Reference Manual*. Retrieved February 26, 2008, from <http://www.armycadetleague.ca/Templates/refManual.htm>.



ROYAL CANADIAN ARMY CADETS

SILVER STAR

INSTRUCTIONAL GUIDE



SECTION 4

**EO C307.01 – PARTICIPATE IN A PRESENTATION GIVEN BY A
GUEST SPEAKER FROM THE REGIONAL CADET SUPPORT UNIT**

Total Time:

60 min

THERE IS NO INSTRUCTIONAL GUIDE PROVIDED FOR THIS EO.

THIS PAGE INTENTIONALLY LEFT BLANK



ROYAL CANADIAN ARMY CADETS

SILVER STAR

INSTRUCTIONAL GUIDE



SECTION 5

EO C307.02 – PARTICIPATE IN A PRESENTATION GIVEN BY THE CADET LIAISON OFFICER

Total Time:

60 min

THERE IS NO INSTRUCTIONAL GUIDE PROVIDED FOR THIS EO.

THIS PAGE INTENTIONALLY LEFT BLANK



ROYAL CANADIAN ARMY CADETS

SILVER STAR

INSTRUCTIONAL GUIDE



SECTION 6

**EO C307.03 – PARTICIPATE IN A PRESENTATION GIVEN BY A
GUEST SPEAKER FROM THE ARMY CADET LEAGUE OF CANADA**

Total Time:

60 min

THERE IS NO INSTRUCTIONAL GUIDE PROVIDED FOR THIS EO.

THIS PAGE INTENTIONALLY LEFT BLANK

FULL VALUE CONTRACT

Full Value Contract: The Circle

1. Draw a wheel. At the centre of the wheel, draw a circle. This circle represents the individuals, the group, and the goals.
2. Draw rays from this circle. On these rays, write each selected value.
3. The outer circle symbolizes that the group is one and that all members go toward the same direction.
4. Without the respect of the chosen values by everyone, the group could not make a wheel, and could not walk toward the same goals.

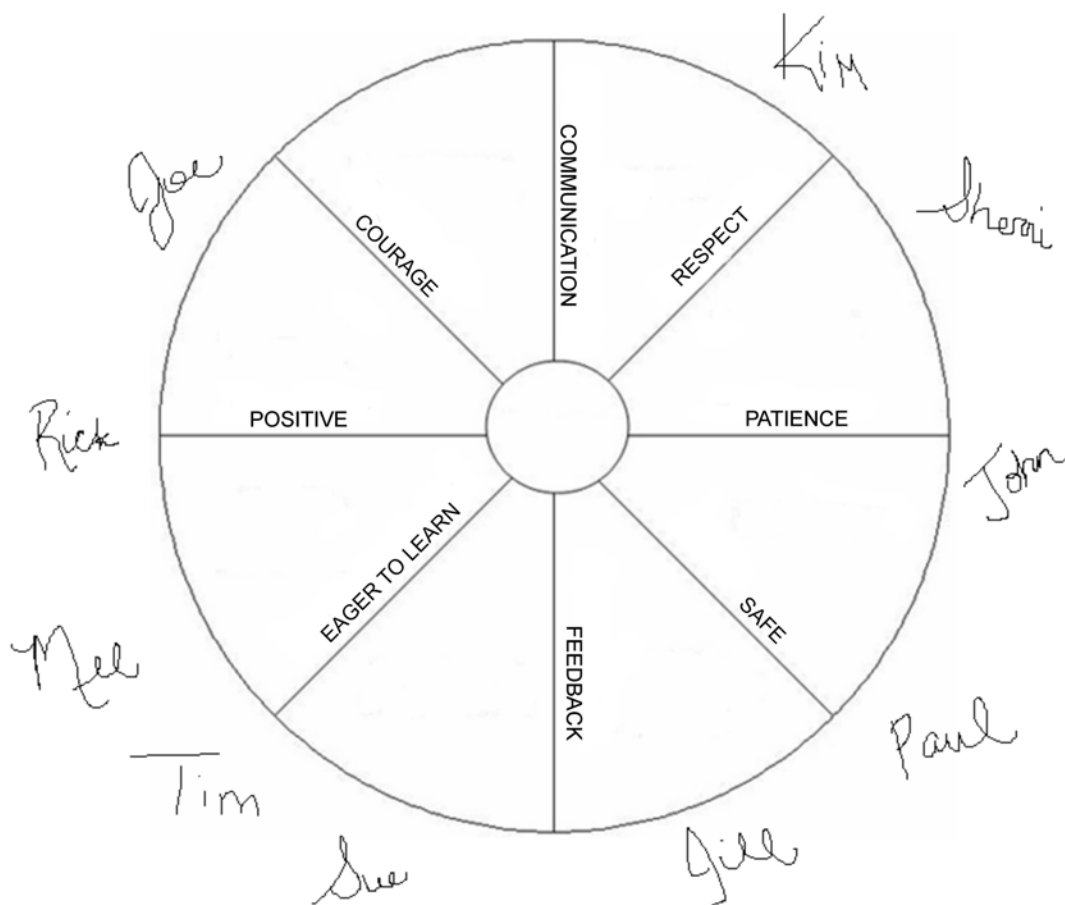

Director Cadets 3, 2007, Ottawa ON: Department of National Defence

Figure 7A-1 The Circle

Full Value Contract: The Village

1. Draw a frame (village) on cardboard or flipchart paper.
2. Have the cadets think about values, qualities, and behaviours that make them feel safe and respected, both as an individual and in a group setting.
3. Have each cadet select their most important value, quality, or behaviour.
4. Have each cadet represent what they chose by drawing or writing it on a piece of paper.
5. Have each cadet glue their drawing or writing inside the village and briefly explain to the others why that choice was made.
6. Repeat the activity by including something that will prevent the group from reaching their goals and affect the running of the village.
7. Have each cadet explain why they chose their representation.
8. Have each cadet glue their drawing or writing outside the village.
9. Discuss the values selected by the cadets (inside and outside the village) and ask if everyone agrees. The cadets must understand that they are agreeing to respect each person's value, quality or behaviour in order for the cadet corps (village) to run properly and be a place where everyone will feel safe and respected.
10. After everyone has agreed, everyone (staff and cadets) will sign the village.

Full Value Contract: The Five-Finger Contract

Each finger will represent a value that will help the group members feel secure, respected, and part of the group.

The five fingers on the hand represent the following:

- the little finger = safety,
 - the ring finger = commitment,
 - the middle finger = respect of others,
 - the index finger = taking responsibilities, and
 - the thumb = agreement to work toward the group's goals.
1. On a piece of cardboard or flip chart paper, write the representations of the fingers. Discuss the elements with the group so that all cadets have a clear understanding. Each cadet must agree that these five elements are important for group members to feel secure, respected, and part of the group.
 2. Have each cadet draw his/her hand on a sheet of paper and write inside each finger the element associated with each.
 3. Have each cadet sign their hand and glue it on bristol board or flip chart paper. The set of the group's hands represents everyone's commitment to each other.



Director Cadets 3, 2007, Ottawa ON: Department of National Defence

Figure 7A-2 The Five Finger Contract

Full Value Contract: The Being

1. Draw the outline of a body on two pieces of flip chart paper, taped together.
2. Inside the outline, have the cadets draw or write the behaviours, qualities or values that will make the environment safe and a place where everyone is respected.
3. Outside the outline, have the cadets draw or write the behaviours, qualities or values that will prevent the environment from being safe and a place where everyone is respected.
4. Cadets must agree on the meaning of each word and explain their choices.
5. Have all cadets sign the being.

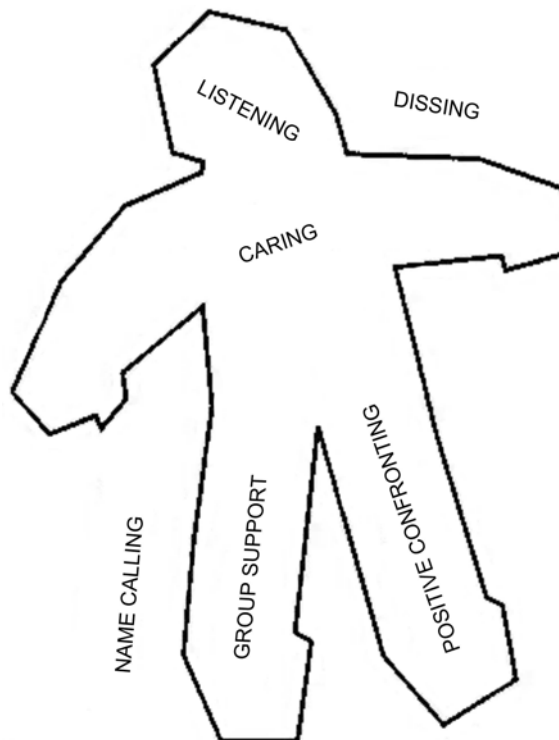

M. Henton, Adventure in the Classroom: Using Adventure to Strengthen Learning and Build a Community of Life-Long Learners, Kendall Hunt Publishing. (p. 74)

Figure 7A-3 The Being

Full Value Contract: The Chain of Hands

1. Have the cadets write a list of words and sentences that describe how they would like to be treated and how they will treat the other group members in order to feel safe and respected.
2. From this list, have the cadets select the 10 most important for the group.
3. On a sheet of flip chart paper (two may be required), have the cadets draw their hands around the sheet. Write the 10 selected words or sentences in the middle of the sheet.
4. Have the cadets sign his or her own hand.



Director Cadets 3, 2007, Ottawa ON: Department of National Defence

Figure 7A-4 The Chain of Hands

Full Value Contract: What do I need? What can I give?

1. Give two pieces of different coloured paper to each cadet.
2. Ask the cadets to think about what they need in order to feel secure and respected in the group.
3. Have the cadets write the most important item they need on one of the pieces of paper.
4. Have the cadets think about what they could provide to the group in order to have other team members feel safe and respected in the group.
5. On the remaining piece of paper, have the cadets write the most important item.
6. When done writing on both pieces of paper, have the cadets present what they wrote to the group.
7. Once everyone has explained what they need and what they can provide, glue those pieces of papers on cardboard or flip chart paper, making sure that both categories are spilt up.
8. Ask the cadets if they need more explanations and then have everyone sign.

CHAPTER 8

PO 308 – DIRECT A SQUAD PRIOR TO A PARADE



COMMON TRAINING
SILVER STAR
INSTRUCTIONAL GUIDE



SECTION 1

EO M308.01 – PREPARE A SQUAD FOR PARADE

Total Time:

90 min

PREPARATION

PRE-LESSON INSTRUCTIONS

Resources needed for the delivery of this lesson are listed in the lesson specification located in A-CR-CCP-703/PG-001, Chapter 4. Specific uses for said resources are identified throughout the instructional guide within the TP for which they are required.

Review the lesson content and become familiar with the material prior to delivering the lesson.

Photocopy the drill sequence handout at Annex A and the aide-mémoire card at Annex B as required.

PRE-LESSON ASSIGNMENT

N/A.

APPROACH

An interactive lecture was chosen for TP 1 to introduce drill theory to the cadet.

Demonstration and performance was chosen for TP 2 as it allows the instructor to explain and demonstrate preparing a squad for a parade while providing an opportunity for the cadets to practice the skill under supervision.

INTRODUCTION

REVIEW

N/A.

OBJECTIVES

By the end of this lesson the cadet shall be expected to prepare a squad for parade.

IMPORTANCE

It is important for cadets to be able to prepare a squad for parade as they will be in placed in a team leader role and will need to know the formations and locations of all members on the parade square.

Teaching Point 1

Explain Drill Theory

Time: 20 min

Method: Interactive Lecture



Drill is the basis of all teamwork throughout the CCM. This lesson provides guidance and establishes uniformity to ensure that cadets move as one in an orderly and efficient manner. Drill promotes precision, pride and the cohesion of a corps through self-discipline and practice.

SQUAD FORMATIONS



The term squad is a generic name for a group of cadets. This term can be interchanged with platoon, flight, division or any other applicable elemental or regimental term.



The squad formation should be implemented when there is a parade strength of less than 32 cadets.

Squad formations are essential to maintain control and ensure uniformity. The instructor shall determine the formation to be used, based on the number of cadets present, to include:

Single Rank. A single rank shall be formed when there are five or fewer cadets.

Two Ranks. Two ranks shall be formed when there are six to nine cadets.

Three Ranks. Three ranks shall be formed when there are 10 or more cadets.

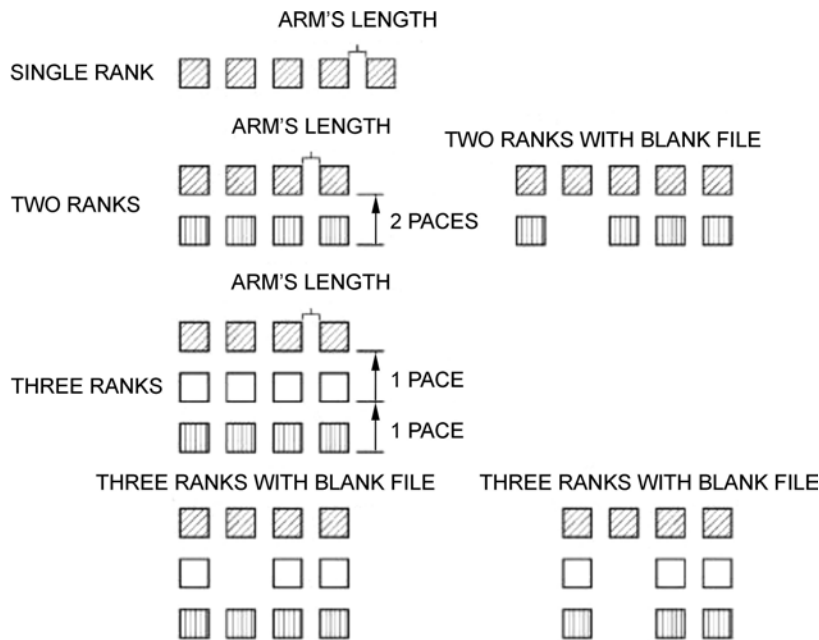

A-PD-201-000/PT-000, *The Canadian Forces Manual of Drill and Ceremonial* (p. 2-2)

Figure 8-1-1 Squad Formations



When there are not enough cadets to form complete files, a file shall be left blank (as illustrated in Figure 8-1-1). The file blank shall be the second file from the left.

In two ranks, this blank file is without a rear rank cadet, and in three ranks, this blank file is without a centre and/or rear rank cadet.

The symbol for the Parade Commander (Pde Comd) is:



The symbol for the Parade Deputy Commander (DComd) is:



The symbol for the Parade Sergeant Major (CSM) is:



The symbol for Platoon Commander (PI Comd) is:



The symbol for the Platoon Warrant Officer (PI WO) is:



The symbol Platoon Marker (Marker) is:



Director Cadets 3, 2008, Ottawa, ON: Department of National Defence

Figure 8-1-2 Parade Appointment Symbols

COMPANY FORMATIONS

A company consists of two or more platoons. The aim of company drill is to manoeuvre the company as one under the command of a parade commander and assistance of a parade deputy commander. Other senior non-commissioned officers (NCOs) not directly involved with the platoons, shall be supernumeraries and form supernumerary ranks as directed by the parade commander. There shall be seven paces between platoons for all formations.



When space is limited, intervals and distances between platoons may be decreased.

There are three company formations used by cadets, to include:

Line. A company is formed in line when platoons are formed up side-by-side, seven paces apart and aligned facing the front, with parade appointments located in the front and rear of the formation (as illustrated in Figure 8-1-3).



To be formed in threes and in line is the common formation when a squad forms up.

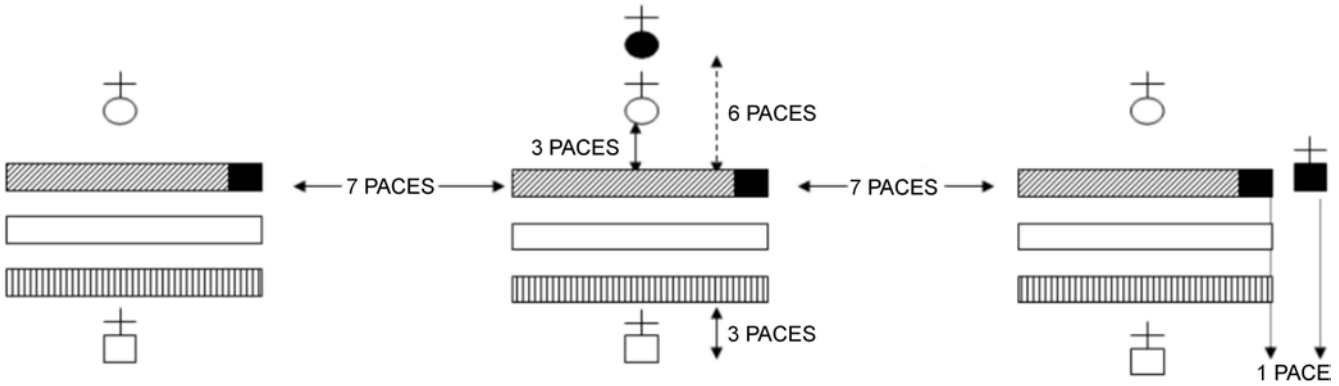

Director Cadets 3, 2008, Ottawa, ON: Department of National Defence

Figure 8-1-3 Company in Line

Column of Threes. A company is formed in column of threes when platoons are turned to the right or left of the front, with parade appointments located in their positions in the front and rear of the formation and turned to the right or left with the platoon (as illustrated in Figure 8-1-4).

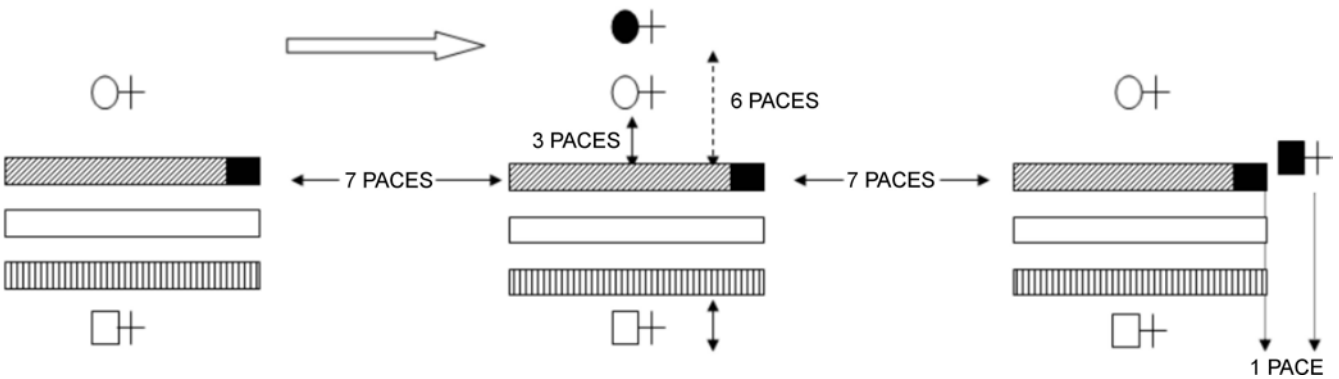

Director Cadets 3, 2008, Ottawa, ON: Department of National Defence

Figure 8-1-4 Company in Column of Threes

Column of Route. A company is formed in column of route when platoons are turned to the right or left, with parade appointments positioned to lead or follow the formation (as illustrated in Figure 8-1-5).

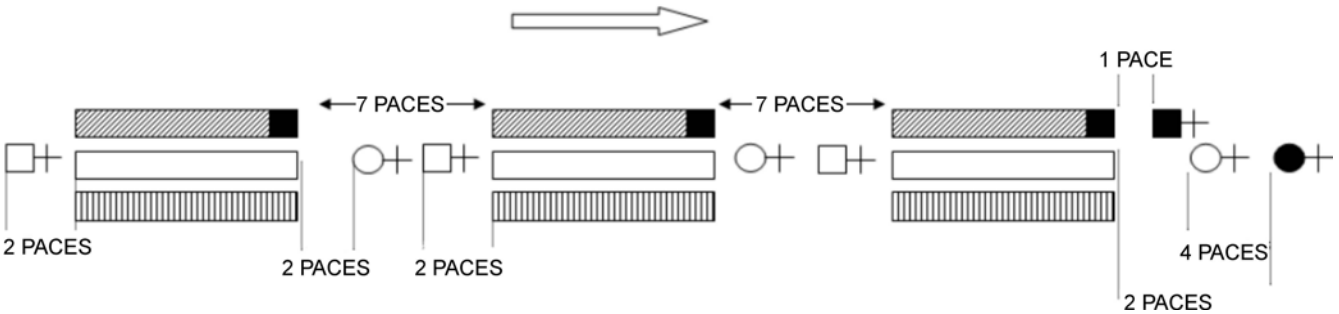

Director Cadets 3, 2008, Ottawa, ON: Department of National Defence

Figure 8-1-5 Company in Column of Route

LOCATION OF PARADE APPOINTMENTS

The unique nature of the cadet unit allows for the adjustment of parade positions to be filled by cadet WOs and cadet senior NCOs. The following parade positions are normally filled by cadets when conducting a formal parade:

Parade Commander (Pde Comd). With a company in line or in column of threes, the Pde Comd is centred three paces in front of the line of platoon commanders, facing the same direction as the platoons except when addressing the company. With a company in column of route, the Pde Comd is centred four paces in front of the leading platoon.

Parade Deputy Commander (DComd). The DComd is an appointment that is seldom assigned in a cadet corps. If applicable, the DComd is centred three paces in front of the second single file from the right flank of the company and in line with the PI Comd.

Parade Sergeant Major (CSM). With a company in line or in column of threes, the CSM is located one pace to the right of the No. 1 Platoon marker, in line with the front rank. With a company in column of route, the CSM is located one pace in front of the directing flank of the leading platoon.

Platoon Commander (PI Comd). With a company in line or in column of threes, the PI Comd is centred three paces in front of the platoon. With a company in column of route, the PI Comd is centred two paces in front of their platoon.

Platoon Warrant Officer (PI WO). With a company in line or in column of threes, the PI WO is centred three paces in rear of the platoon. With a company in column of route, the PI WO is centred two paces in the rear of their platoon.



Prior to handing over to the PI Comd, the PI WO will be centred three paces in front of the platoon. After handing over to the PI Comd, the PI WO assumes their position as stated above.

Platoon Marker (Marker). The marker is the individual placed in the first rank of the first file to indicate the position which a body of cadets will occupy when covering and falling in. In all squad and company formations, the marker remains in the same location.

CONFIRMATION OF TEACHING POINT 1

QUESTIONS

- Q1. What are the three squad formations?
- Q2. What are the three company formations?
- Q3. Where is the PI Comd located when the formation is in line?

ANTICIPATED ANSWERS

A1. The three squad formations are:

- single rank,
- two ranks, and
- three ranks.

A2. The three company formations are:

- line,
- column of threes, and
- column of route.

A3. The PI Comd is located three paces in front and centre of the platoon.

Teaching Point 2

Explain, Demonstrate and Have the Cadet Assume the Role of a Team Leader in Preparing a Squad for Parade

Time: 60 min

Method: Demonstration and Performance

When preparing a squad for parade, the team leader, acting as the PI WO, is responsible to ensure the squad is ready for parade by:

1. having the squad on the parade square by falling in a squad;
2. knowing who is present or absent by calling the roll;
3. ensuring uniformity of the squad by sizing in single rank and reforming threes (twos);
4. ensuring the squad is properly spaced by dressing a squad;
5. ensuring all cadets are well turned out by inspecting a squad; and
6. continuing with the parade by handing over the squad.



The purpose of this TP is to aid the cadets' comprehension of the process they have executed during Green and Red Star when preparing for parade during a training sessions.



If the time allotted is not sufficient for all cadets to assume the role of a team leader in preparing a squad for parade, additional time during nightly opening and closing parades shall be used to provide all cadets the opportunity for performance.

ACTIVITY

OBJECTIVE

The objective of this activity is to confirm the ability of a Silver Star cadet, as a team leader, to prepare a squad for parade.

RESOURCES

N/A.

ACTIVITY LAYOUT

N/A.

ACTIVITY INSTRUCTIONS

Distribute a copy of the drill sequence handout at Annex A and an aide-mémoire card at Annex B to each cadet.

This activity will be conducted IAW Annex A.



For this activity, it is recommended that instruction take the following format:

1. Explain and demonstrate the complete skill while cadets observe.
2. Explain and demonstrate each step required to complete the skill.
3. Select a cadet to assume the role of team leader and practice the complete skill.

Note: Assistant instructors may be employed for demonstration purposes.

SAFETY

N/A.

CONFIRMATION OF TEACHING POINT 2

The cadets' participation in the activity will serve as the confirmation of this TP.

END OF LESSON CONFIRMATION

The cadets' participation in preparing a squad for parade will serve as the confirmation of this lesson.

CONCLUSION

HOMEWORK/READING/PRACTICE

N/A.

METHOD OF EVALUATION

This EO is assessed IAW A-CR-CCP-703/PG-001, Chapter 3, Annex B, Appendix 2 (308 PC).

CLOSING STATEMENT

When preparing a squad for parade with confidence and determination, it will affect how cadets respond to the orders given. Delivering words of command can allow a squad to move as a team in an organized and efficient manner as all members learn to work together.

INSTRUCTOR NOTES/REMARKS

Cadets shall perform these skills and be given feedback during weekly opening and closing parades, and ceremonial parades.

Assistant instructors may be required for this lesson.

REFERENCES

A0-002 A-PD-201-000/PT-000 Director History and Heritage 3-2. (2005). *The Canadian Forces Manual of Drill and Ceremonial*. Ottawa, ON: The Department of National Defence.

THIS PAGE INTENTIONALLY LEFT BLANK



COMMON TRAINING
SILVER STAR
INSTRUCTIONAL GUIDE



SECTION 2

EO M308.02 – DELIVER WORDS OF COMMAND

Total Time:	30 min
-------------	--------

PREPARATION

PRE-LESSON INSTRUCTIONS

Resources needed for the delivery of this lesson are listed in the lesson specification located in A-CR-CCP-703/PG-001, Chapter 4. Specific uses for said resources are identified throughout the instructional guide within the TP for which they are required.

Review the lesson content and become familiar with the material prior to delivering the lesson.

Photocopy, cut out, fold and laminate the aide-mémoire cards with the words of command located at Annex B for each cadet.

PRE-LESSON ASSIGNMENT

N/A.

APPROACH

An interactive lecture was chosen for TP 1 to orient the cadets to the parts of a command and to generate interest.

Demonstration was chosen for TP 2 as it allows the instructor to demonstrate the voice techniques the cadets are expected to acquire.

INTRODUCTION

REVIEW

N/A.

OBJECTIVES

By the end of this lesson the cadet shall be expected to deliver words of command.

IMPORTANCE

It is important for cadets to know how to deliver words of command. Words of command that are delivered in a clear and concise manner, with confidence and determination, will affect how cadets respond to orders. Words of command are required to move a platoon in an organized and efficient manner.

Teaching Point 1**Explain the Parts of a Command**

Time: 10 min

Method: Interactive Lecture

CAUTIONARY COMMAND

A cautionary command shall be given at the beginning of every command to warn the squad that a movement will be performed. It includes additional instructions to the command such as “advance” or “retire”.



The direction of the movements are indicated based on the initial front rank.

The additional instructions are based on the direction a squad falls in (as illustrated in Figure 8-2-1). In general:

- **Advance.** Indicates a turn or movement in the direction of the front rank (is used whenever turning into line).
- **Retire.** Indicates a turn or movement in the direction of the rear rank (is used whenever turning into line).
- **Move to the Right/Left.** Indicates a turn or movement in the direction of the indicated flank (eg, the right/left markers).

EXECUTIVE COMMAND

An executive command is to signal that the movement is to be carried out.

When written, a dash shall separate the cautionary command from the executive command.

The following are examples of words of command. In these examples, the word “TURN” indicates the executive command.

- “SQUAD RETIRE, RIGHT—TURN,”
- “SQUAD ADVANCE, LEFT—TURN,” and
- “SQUAD MOVE TO THE RIGHT IN COLUMN OF ROUTE, RIGHT—TURN.”

On the march, the cautionary command should be drawn out over at least two paces of quick time and the interval between the cautionary and executive commands should be two paces.



The order, “As You Were”, should only be given when another word of command cannot be given to have a squad adopt a previous position or to cancel an incorrect order before it has been completed.

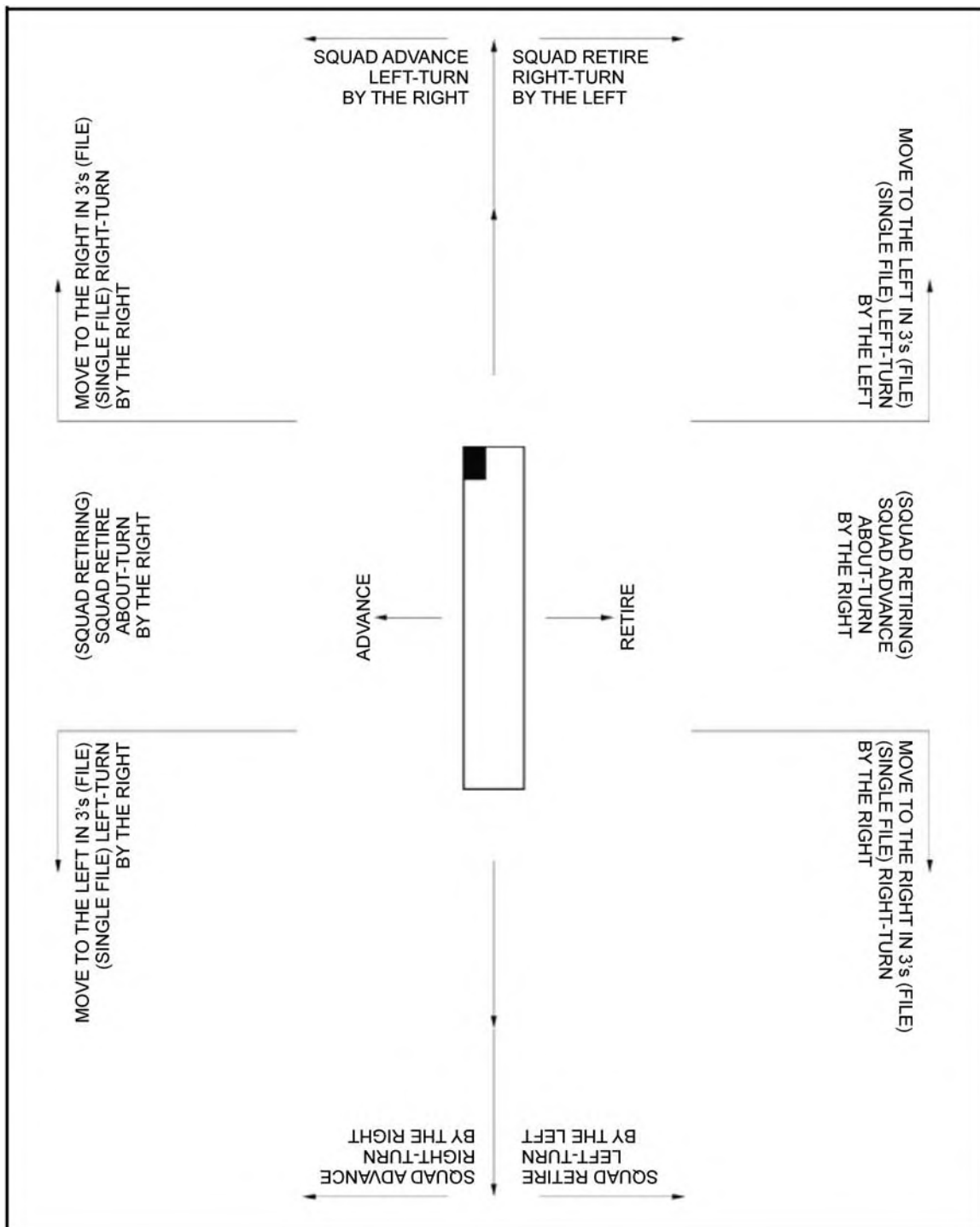

A-PD-201-000/PT-000 (p. 3-4)

Figure 8-2-1 Advance/Retire and Directing Flanks

CONFIRMATION OF TEACHING POINT 1

QUESTIONS

- Q1. Why are cautionary commands given?
- Q2. What is the purpose of the executive command?
- Q3. When commands are written, what is the purpose of the dash?

ANTICIPATED ANSWERS

- A1. To warn the squad that a movement will be performed.
- A2. To signal that the movement is to be carried out.
- A3. To separate the cautionary from the executive command.

Teaching Point 2

Demonstrate and Explain the Requirements for a Well-Delivered Command

Time: 15 min

Method: Demonstration



As each point is discussed, give an example of a command being delivered correctly and incorrectly, using the specified technique.

VOICE

The voice used to deliver commands has a strong effect on how others will respond. The following points should be considered:

Volume. The volume used to deliver a command is very important in drill. Often, commands must be presented to a group over a band or over other cadets giving commands to another group. The volume should be adjusted based on the number of individuals, the distance the command must carry and whether there is a band or not.

Projection. The projection of the voice is its ability to reach a desired distance. Erect posture, proper breathing, a relaxed throat and an open mouth will help a voice project.

Distinctness. How clearly and distinctly a command is pronounced will affect how others respond. If a command is not clear and distinct some cadets may not understand the command and perform the wrong movement. Clear enunciation and pronunciation of commands is key in distinctness.

Inflection. Inflection is the change in pitch of the voice. The cautionary command is usually started with a pitch near the level of the normal speaking voice and rising toward the end. The executive command should not have any change in inflection but should be delivered with a higher pitch than the cautionary command.

Snap. The snap of a command is the quality that demands an immediate response. It expresses the confidence and decisiveness of the commander.

ACCURACY

Commands must be given with accuracy at all times. Proper use of cautionary commands will alert the cadets to what is coming. The executive command will signal the cadets that the movement is to be carried out. When delivering executive commands on the march, it is important that it be delivered on the correct foot.

CONFIDENCE

All words of command must be given with confidence. This portrays that it is an order that must be promptly and smartly obeyed. A command delivered with confidence will help build a sense of security in the commander from the members of the squad.

CORRECT POSTURE

Poor posture restricts the ability to breathe deeply as it restricts the movement of the diaphragm. Maintaining good posture will allow a cadet to breathe deeply allowing the command to come deep from the diaphragm instead of from the throat causing less strain on the throat and allowing the command to be given with more volume.

BREATHING CONTROL

Breathe deeply and relax the muscles in the neck and vocal cords in order to give the voice more control and a higher volume. This will allow the voice to come from deep in the diaphragm instead of higher in the throat.

CONFIRMATION OF TEACHING POINT 2

QUESTIONS

- Q1. If a command is not pronounced clearly and distinctly, what affect may it have on the squad being commanded?
- Q2. Why should commands be delivered with confidence?
- Q3. How does poor posture affect delivering commands?

ANTICIPATED ANSWERS

- A1. Cadets may not understand the command and perform the wrong movement.
- A2. It portrays that it is an order that must be promptly and smartly obeyed.
- A3. It restricts the ability to breathe deeply, restricting the movement of the diaphragm, which will cause commands to come from the throat.

END OF LESSON CONFIRMATION

QUESTIONS

- Q1. What order is given to cancel an incorrect order before it has been completed?
- Q2. What are the five points of voice to be considered for a well-delivered command?
- Q3. What gives the voice more control and a higher volume?

ANTICIPATED ANSWERS

- A1. The order, "As You Were".

- A2. Volume, projection, distinction, inflection and snap.
- A3. Breathing deeply and relaxing the muscles in the neck and vocal cords.

CONCLUSION

HOMEWORK/READING/PRACTICE

N/A.

METHOD OF EVALUATION

N/A.

CLOSING STATEMENT

When words of command are delivered in a clear and concise manner and with confidence and determination, it will affect how cadets respond to the order. Delivering words of command can allow a platoon to move as a team in an organized and efficient manner as all members learn to work together.

INSTRUCTOR NOTES/REMARKS

Cadets shall be provided the opportunity to deliver words of command and be given feedback during weekly opening and closing parades, and ceremonial parades.

Additional time for this EO is available in EO C308.02 (Deliver Words of Command, Section 4).

REFERENCES

- A0-002 A-PD-201-000/PT-000 Director History and Heritage 3-2. (2005). *The Canadian Forces Manual of Drill and Ceremonial*. Ottawa, ON: Department of National Defence.
- C0-022 (ISBN 0-02-864207-4) Cole, K. (2002). *The Complete Idiot's Guide to Clear Communication*. Indianapolis, IN: Alpha Books.
- C0-241 Optimal Breathing. (2007). *Posture and Breathing*. Retrieved February 12, 2008, from <http://breathing.com/articles/posture.htm>.
- C0-269 AFMAN 36-2203 Department of the Air Force. (1996). *Drill and Ceremonies*. Lackland, AFB, TX: Secretary of the Air Force.



COMMON TRAINING
SILVER STAR
INSTRUCTIONAL GUIDE



SECTION 3

EO C308.01 – EXECUTE FLAG DRILL

Total Time:

180 min

PREPARATION

PRE-LESSON INSTRUCTIONS

Resources needed for the delivery of this lesson are listed in the lesson specification located in A-CR-CCP-703/PG-001, Chapter 4. Specific uses for said resources are identified throughout the instructional guide within the TP for which they are required.

Review the lesson content and become familiar with the material prior to delivering the lesson.

For further direction and information on cadet flags and banners, refer to CATO 12-05, *Cadet Flags and Banners*, Paragraphs 1. to 9.

PRE-LESSON ASSIGNMENT

N/A.

APPROACH

An interactive lecture was chosen for TP 1 to present basic background material on flags and flag parties.

Demonstration and performance was chosen for TPs 2–6 as it allows the instructor to demonstrate and explain the skills the cadets are expected to acquire while providing an opportunity for the cadets to practice flag drill under supervision.

INTRODUCTION

REVIEW

N/A.

OBJECTIVES

By the end of this lesson the cadet, as a member of a flag party, shall have executed flag drill.

IMPORTANCE

It is important for cadets to execute flag drill so they are able to take part in ceremonies and parades as members of the flag party at the corps, cadet summer training centre (CSTC) and other community events as required. Colours and flags have many meanings and are symbols of such things as achievements, nationality and identity. It is considered an honour to be a member of the flag party.

Teaching Point 1**Explain Details of Flags, the Pike, the Colour Carrying Belt and the Composition of a Flag Party**

Time: 10 min

Method: Interactive Lecture

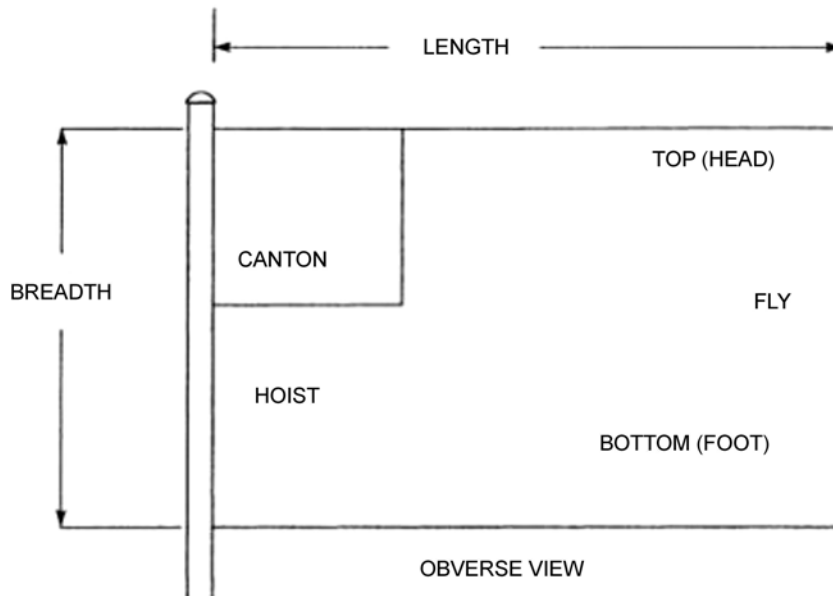
FLAGS

A-AD-200-000/AG-000, *The Honours, Flags and Heritage Structure of the Canadian Forces* (p. 4-1-8)

Figure 8-3-1 Details of a Flag

Flags. As a generic term (including colours), flags are pieces of bunting or other material, attachable to a pike, staff or halyard, and used as a means of identification or for signalling.

Canton. The upper half of the hoist. It is also called the First Quarter and sometimes the Upper Hoist. The canton is considered the place of honour on a flag.

Hoist. The half of the flag nearest to the halyard.

Halyard. The rope that raises or lowers a flag.

Fly. The half of the flag furthest from the halyard.

Staff (Flagstaff). A pole on which a flag is mounted for display.



Colours are consecrated ceremonial flags carried to mark the identity of Canadian Forces (CF) formations and units. They belong to a separate class and are not paraded with other flags. Cadet flags are not consecrated (made sacred and devoted to service by the Chaplain General as symbols of honour and duty), therefore shall not be referred to as colours.

Commanding Officers of cadet corps and CSTCs shall ensure that flags and banners are not referred to as colours, adorned with honours or consecrated and not issued at public expense.

Flags are used to identify individuals and groups. Many flags which originated as the insignia of individuals gradually came to represent the state or agencies within the state.

Authorized Flags and Banners

The following is a list of flags and banners that may be carried on parade by cadet units:

1. the Royal Canadian Sea Cadets Ensign,
2. the Royal Canadian Army Cadets Flag,
3. the Royal Canadian Air Cadets Ensign, and
4. the Royal Canadian Air Cadets Squadron Banner.

The following is a list of flags and banners that should only be carried on ceremonial parades to indicate a cadet formation:

1. the Royal Canadian Army Cadets Banner,
2. the Royal Canadian Army Cadets Trumpet Banner,
3. the Royal Canadian Army Cadets Pipe Banner,
4. the Royal Canadian Air Cadets Banner, and
5. the Royal Canadian Air Cadets Pipe Banner.

THE PIKE

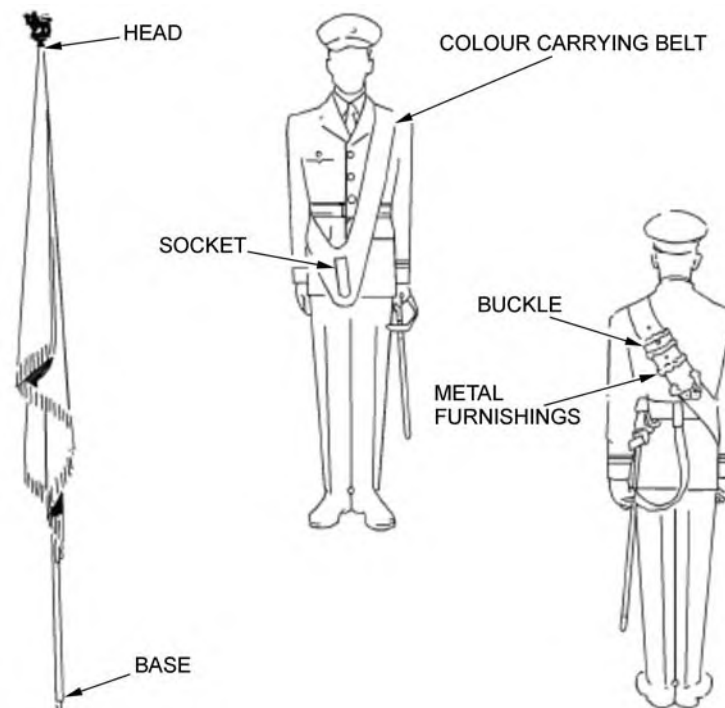

A-PD-201-000/PT-000 (p. 8-2-3)

Figure 8-3-2 Details of the Pike and Colour Carrying Belt

Pike. A pole on which colours or other flags are mounted for carrying or displaying.

Pike Head. The decorative ornament (finial) on the top of a pike, staff or pole.

COLOUR CARRYING BELT

The colour carrying belt is worn over the left shoulder by members of the flag party carrying flags. The socket is the “pocket” where the pike base is placed while the flag is in the carry position.

COMPOSITION OF A FLAG PARTY

LEGEND

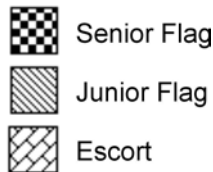

Director Cadets 3, 2008, Ottawa, ON: Department of National Defence

Figure 8-3-3 Flag Party Legend



Director Cadets 3, 2008, Ottawa, ON: Department of National Defence *Director Cadets 3, 2008, Ottawa, ON: Department of National Defence*

Figure 8-3-4 Flag Party for One Flag

Figure 8-3-5 Flag Party for Two Flags

The composition of a flag party carrying one flag (as illustrated in Figure 8-3-3) consists of the flag party commander (cadet carrying the flag) and two escorts (cadets on either side of the flag).

The composition of a flag party carrying two flags (as illustrated in Figure 8-3-4) consists of one senior escort (cadet between the flags), the flag party commander and one flag bearer (cadets carrying the flags) and two senior NCOs (cadets directly behind the flags).

The flag party commander and/or flag bearer is appointed to carry, handle and protect the flags.

The senior escort and/or escort are appointed to safeguard the flags. They remain with the flags and may or may not carry drill-purpose rifles.



When a flag party carries the national flag and either the CF Ensign or a command flag, the national flag occupies the position of honour on the right (on the left from the spectators view) and is normally carried by a senior cadet.

Normally, the national flag does not have an escort. It may be given an escort with a drill-purpose rifle if the cadets on parade are carrying drill-purpose rifles.

CONFIRMATION OF TEACHING POINT 1

QUESTIONS

- Q1. What is a pike?
- Q2. Over which shoulder is the colour carrying belt worn?
- Q3. How many members are in a flag party with only one flag?

ANTICIPATED ANSWERS

- A1. A pike is a pole on which colours or other flags are mounted for carrying or displaying.
- A2. The colour carrying belt is worn over the left shoulder.
- A3. There are three members in a flag party with only one flag: the flag party commander and two escorts.

Teaching Point 2

**Demonstrate, Explain and Have the Cadets Practice
Adopting the Order, Stand at Ease From the Order, Stand
Easy From the Stand at Ease, Stand at Ease From the Stand
Easy and Order From the Stand at Ease With a Flag**

Time: 15 min

Method: Demonstration and Performance



Develop and use a vocabulary of short, concise words to impress on the cadets that the movements must be performed smartly. For example, the words “crack”, “drive”, “seize” and “grasp” suggest the degree of smartness required. Profanity or personal sarcasm shall never be used.

Proper drill movements shall be combined with a professional demeanour throughout the period of instruction.

Check for faults and correct them immediately as they occur.



Each TP is to be conducted as follows:

1. Have the cadets fall in, in an effective squad formation (eg, hollow square, semi-circle or single rank).
2. Demonstrate and explain each movement, as time allows.
3. Give the cadets time to practice each movement on their own.
4. After all movements have been demonstrated and practiced, deliver commands and have all the cadets perform them as a squad.



Capitalization indicates the words of command for each movement.

Cadence is to be maintained while completing these movements.

THE ORDER (ATTENTION)



The position for the Order is the same as Attention.



A-PD-201-000/PT-000 (p. 8-3-2)

Figure 8-3-6 The Order (Attention)

To assume the position of the order (attention), the cadets shall:

1. Stand with heels together and in line, with the feet turned out to form an angle of 30 degrees.
2. Maintain balance and distribute weight evenly on both feet.
3. Keep the shoulders squared and to the front.
4. Hold the head erect with the neck touching the back of the collar, eyes steady, looking directly to the front.
5. Hold the pike vertical in the right hand, along the right side.
6. Keep the base of the pike on the ground at the right foot in line with the small toe.
7. Hold the pike and flag with an all-round grasp with the right hand, with the back of the hand pointed outwards at the point of the pike where the lowest corner of the flag hangs.
8. Ensure the flag hangs naturally down the pike and is not pulled taut.
9. Keep the right elbow at the side.
10. Hold the left arm at the position of attention.

STAND AT EASE FROM THE ORDER

A-PD-201-000/PT-000 (p. 8-3-2)

Figure 8-3-7 Stand at Ease

On the command, **STAND AT—EASE**, the cadets shall:

1. bend the left knee and place the left foot smartly on the ground 25 cm (approximately 10 inches) to the left;
2. maintain the left arm in the position of attention; and
3. maintain the pike and flag in the position of the order.



Timing for this movement is one.

STAND EASY FROM STAND AT EASE

On the command, **STAND—EASY**, the cadets shall:

1. maintain the feet at the position of stand at ease;
2. keep the left arm at the side; and
3. relax the body.



Timing for this movement is one.

STAND AT EASE FROM STAND EASY

On the command, SQUAD, the cadets shall resume the position of stand at ease.



Timing for this movement is one.

ORDER FROM STAND AT EASE

On the command, ATTEN—TION, the cadets shall:

1. bend the left knee and bring the left foot to the position of attention, keeping the left arm at the side; and
2. maintain the pike and flag in the position of the order.



Timing for this movement is one.

CONFIRMATION OF TEACHING POINT 2

The cadets' practicing of the order, stand at ease and stand easy, with a flag, will serve as the confirmation of this TP.

Teaching Point 3

Demonstrate, Explain and Have the Cadets Practice Adopting the Carry From the Order, Order From the Carry, Let Fly From the Carry and Catch the Flag From the Let Fly

Time: 25 min

Method: Demonstration and Performance

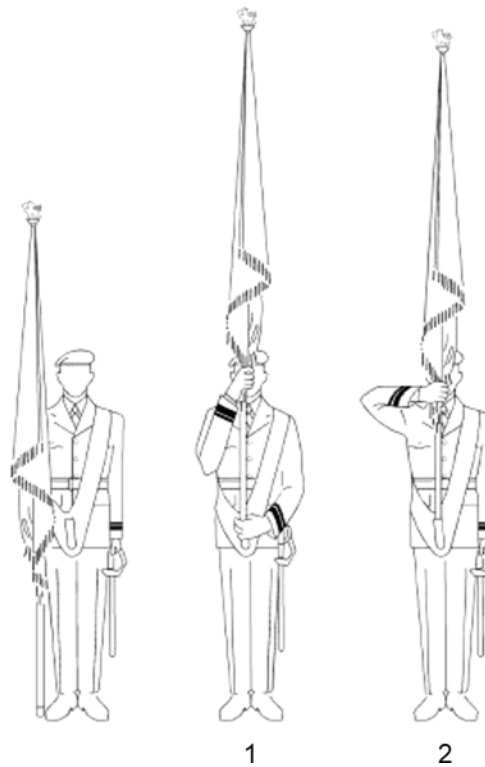
CARRY FROM THE ORDER

A-PD-201-000/PT-000 (p. 8-3-4)

Figure 8-3-8 Carry From the Order

On the command, CARRY—FLAGS, the cadets shall:

1. on the first movement:
 - a. with the right hand, carry the flag to a vertical position in front of the centre of the body, keeping the right forearm along the side of the pike, and keeping the base of the pike just over the socket of the carrying belt; and
 - b. simultaneously, bring the left hand to the socket and guide in the base of the pike; and
2. on the second movement:
 - a. cut the left hand to the side in the position of attention; and
 - b. simultaneously, bring the right forearm parallel to the ground so that upon completion of the movement, the right hand is opposite the mouth with the back of the right hand facing out, the wrist straight and the forearm parallel to the ground.



Timing for this movement is one-two-three, one.

ORDER FROM THE CARRY

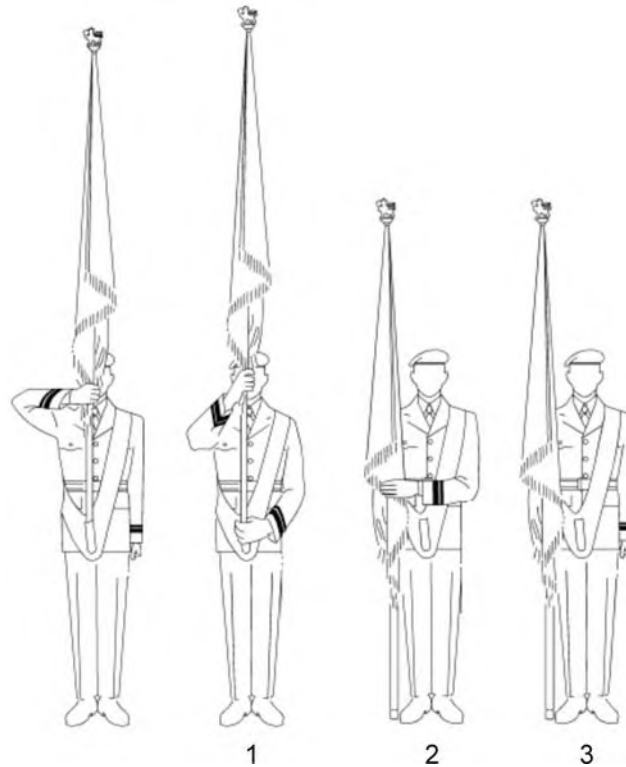

A-PD-201-000/PT-000 (p. 8-3-6)

Figure 8-3-9 Order From the Carry

On the command, ORDER—FLAGS, the cadets shall:

1. on the first movement:
 - a. bring the right forearm from a horizontal to a vertical position along the pike and with the right hand, raise the pike clear of the socket of the carrying belt; and
 - b. simultaneously, bring the left hand to the socket to steady the pike and the carrying belt; and
2. on the second movement:
 - a. carry the flag with the right hand to the position of the order; and
 - b. simultaneously, move the left hand across the body to steady the pike with the forearm parallel to the ground, the back of the hand facing out, and the fingers of the left hand together, extended and pointing to the right; and
3. on the third movement, cut the left hand to the side in the position of attention.



Timing for this movement is one-two-three, one-two-three, one.

LET FLY FROM THE CARRY



Let fly is used either as a salute to dignitaries or to allow for the identification of the flag.

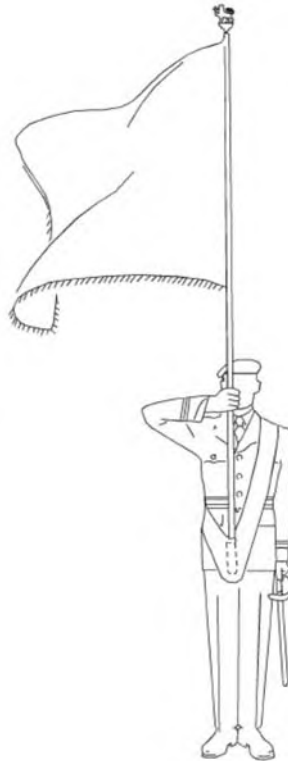

A-PD-201-000/PT-000 (p. 8-3-17)

Figure 8-3-10 Let Fly From the Carry

On the command LET FLY THE—FLAG(S), the cadets shall:

1. maintain the grip of the pike; and
2. simultaneously release the flag with a downward movement of the right hand.

This drill movement is also used on the commands:

- GENERAL SALUTE—SALUTE; and
- EYES—RIGHT during a march past (the flag is let fly on the next left foot).



Timing for this movement is one.

CATCH THE FLAG FROM THE LET FLY

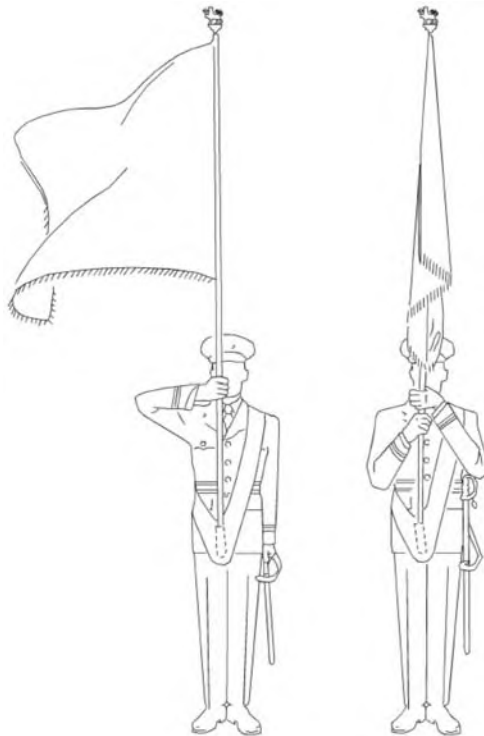

A-PD-201-000/PT-000 (p. 8-3-18)

Figure 8-3-11 Catch the Flag From the Let Fly

On the command, CATCH THE— FLAG(S), the cadets shall:

1. on the first movement:
 - a. grasp the flag with the left hand and bring it in to the pike; and
 - b. simultaneously, grasp the corner of the flag with the right hand, back of the hand outwards, at the point of the pike where the lowest corner of the flag reached; and
2. on the second movement, cut the left hand to the side to the position of attention and raise the right forearm to the horizontal position.

This drill movement is also used on the commands:

- ATTEN—TION following the General Salute; and
- EYES—FRONT during the march past.



Timing for this movement is one-two-three, one.



Depending on the wind direction, the flag may be grasped with the right hand after securing the pike in the left hand. If, because of wind strength, the flag cannot be caught, the flag shall be brought to the position of the order, the flag secured and returned to the carry.

CONFIRMATION OF TEACHING POINT 3

The cadets' practicing of carry from the order, order from the carry, let fly and catch the flag will serve as the confirmation of this TP.

Teaching Point 4

Demonstrate, Explain and Have the Cadets Practice Marching and Halting in Quick Time and Spiral Countermarching With Flags

Time: 35 min

Method: Demonstration and Performance

MARCHING AND HALTING IN QUICK TIME WITH FLAGS

On the command, QUICK—MARCH, the cadets shall:

1. shoot the left foot forward one half pace (35 cm [14 inches]), with the toe up;
2. strike the heel on the ground first and keep the toe pointed directly forward;
3. simultaneously, swing the left arm back waist high;
4. maintain the right arm in the position of the carry; and
5. continue to march with subsequent standard paces (75 cm [30 inches]).



Timing for this movement is left-right-left.

On the command, SQUAD—HALT, the cadets shall:

1. place the right foot flat on the ground naturally, using the heel as a brake;
2. simultaneously swing the left arm forward, breast-pocket high;
3. take a half pace (35 cm [14 inches]) with the left foot, placing it flat on the ground, swinging the left arm back;
4. bend the right knee and straighten it in double time; and
5. simultaneously, cut the left arm to the side as quickly as possible and assume the position of attention.



The command SQUAD—HALT is given as the left foot is on the ground.



Timing for this movement is one-one-two.



Practice the movements with:

- the **instructor** calling the time;
- the **squad** calling the time; and
- the squad **judging** the time.

Emphasize any movements that the cadets had difficulty with during the lesson.

SPIRAL COUNTERMARCHING WITH FLAGS

An adapted form of the spiral countermarch is used to reverse the direction that the flag party is facing without using as much space as is required for a double wheel by the flag party.

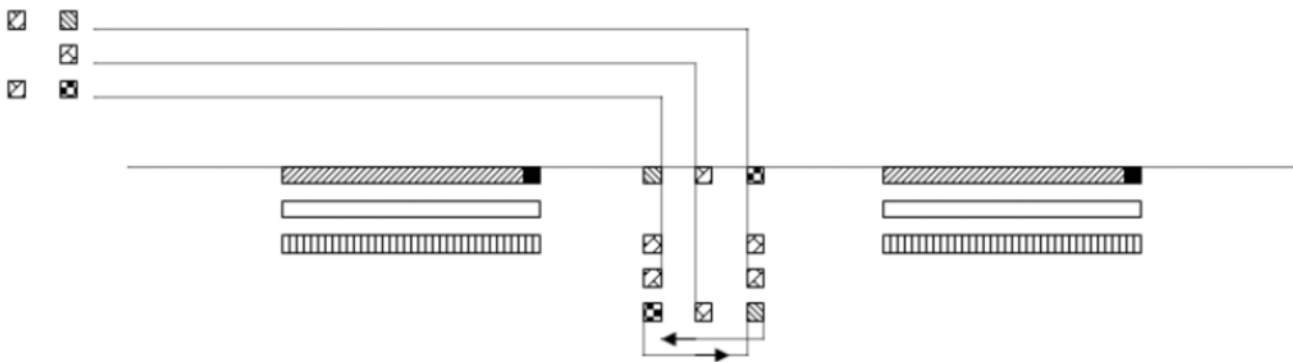

Director Cadets 3, 2008, Ottawa, ON: Department of National Defence

Figure 8-3-12 Spiral Countermarch

On the command, FLAG PARTY, SPIRAL COUNTER—MARCH:

1. all cadets shall maintain the same cadence;
2. the cadets in the file on the right shall perform two consecutive left wheel movements;
3. the cadets in the centre and the file on the left shall perform two consecutive right wheel movements; and
4. the escorts in the rear rank shall follow the flag bearer to their front into position while maintaining dressing.



It is recommended to end this lesson here and teach TPs 5 and 6 during a second session.

CONFIRMATION OF TEACHING POINT 4

The cadets' participation in practicing marching and halting, and spiral countermarching with flags will serve as the confirmation of this TP.

Teaching Point 5**Demonstrate, Explain and Have the Cadets Practice Forming to the Right and Left With Flags**

Time: 40 min

Method: Demonstration and Performance

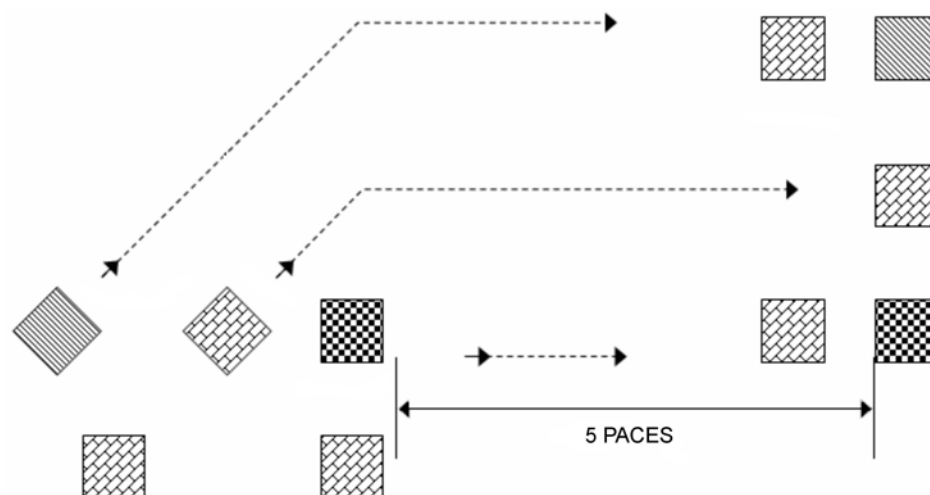

A form changes the direction faced by a flag party in line while maintaining its formation.

CHANGE DIRECTION BY FORMING AT THE HALT

Director Cadets 3, 2008, Ottawa, ON: Department of National Defence

Figure 8-3-13 Right Form

To change direction by forming at the halt to the halt, the following movements shall occur:

On the command **AT THE HALT, CHANGE DIRECTION RIGHT (LEFT), RIGHT (LEFT)—FORM:**

1. the leading person on the directing flank turns right (left);
2. simultaneously, the remainder of the front rank makes a right (left) incline; and
3. the rear ranks stand fast.

On the command **QUICK—MARCH:**

1. the leading person of the directing flank marches forward five paces and halts;
2. simultaneously, the remainder of the squad steps off, wheeling as necessary to regain their original position to the left (right) of the directing flank; and
3. each successive file halts in succession from right to left (left to right), facing the new direction.

CHANGE DIRECTION BY FORMING ON THE MARCH



The command CHANGE DIRECTION RIGHT (LEFT), RIGHT (LEFT)—FORM is given as the left (right) foot is on the ground.

To change direction by forming on the march, the following movements shall occur:

On the command CHANGE DIRECTION RIGHT (LEFT), RIGHT (LEFT)—FORM:

1. the leading person of the directing flank makes a right (left) turn, marches forward six paces and marks time;
2. simultaneously, the remainder of the front rank makes a right (left) incline and steps off toward the new position in line with the right (left) flag;
3. the remainder of the squad wheels as necessary to regain their original position to the left (right) of the directing flank; and
4. each successive file marks time, in succession from right to left (left to right), facing the new direction.

On the command FOR—WARD or FLAG PARTY—HALT, the squad acts as ordered.



The commands FOR—WARD and FLAG PARTY—HALT are given as the left foot is on the ground.



Practice the movements with:

- the **instructor** calling the time;
- the **squad** calling the time; and
- the squad **judging** the time.

Emphasize any movements that the cadets had difficulty with during the lesson.

CONFIRMATION OF TEACHING POINT 5

The cadets' practicing of change direction by forming at the halt and on the march will serve as the confirmation of this TP.

Teaching Point 6**Demonstrate, Explain and Have the Cadets Practice
Marching On and Marching Off the Flags**

Time: 45 min

Method: Demonstration and Performance

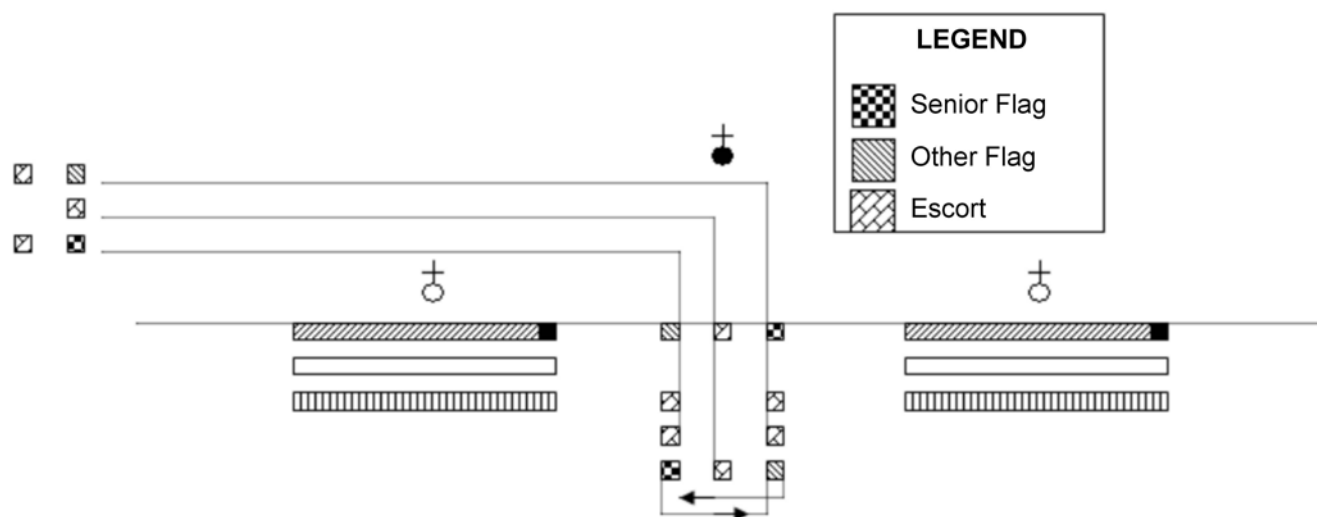

The flag party shall march on and march off the parade from the same flank, either left or right.

MARCHING ON THE FLAG(S)

Director Cadets 3, 2008, Ottawa, ON: Department of National Defence

Figure 8-3-14 March on the Flag(s) From the Left Flank

On the command, MARCH ON THE—FLAG(S), members of the flag party shall perform the following:

1. the flag party commander shall order the cautionary FLAG PARTY;
2. the parade commander shall order TO THE FLAG(S)—SALUTE; and
3. the flag party commander shall order BY THE RIGHT (CENTRE), QUICK—MARCH.

The flag party shall march to its position by a series of forms (as illustrated in Figure 8-3-14).

On the command, FLAG PARTY, SPIRAL COUNTER—MARCH:

1. all cadets shall maintain the same cadence;
2. the cadets in the file on the right shall perform two consecutive left wheel movements;
3. the cadets in the centre and the file on the left shall perform two consecutive right wheel movements; and
4. the escorts in the rear rank shall follow the flag bearer to their front into position while maintaining dressing.

The series of forms shall be conducted as follows:

1. On the command FLAG PARTY, QUICK—MARCH, the flag party shall move as a unit to a location on the parade square centred on the parade commander.

2. On the command FLAG PARTY, CHANGE DIRECTION RIGHT (LEFT), RIGHT (LEFT)—FORM, the flag party shall perform a right (left) form on the march. Upon completion of the form, the cadets shall mark time.
3. The flag party shall resume marching on the command FOR—WARD.
4. The flag party shall perform a spiral countermarch.
5. Upon completion of the spiral countermarch, the flag party shall move to a predetermined location on the parade square.
6. Upon halting in its parade position, the flag party commander orders FLAG PARTY, TO THE FLAG(S)—SALUTE.



If the flag party is armed, the flag party commander will order FLAG PARTY, TO THE FLAG(S), PRESENT—ARMS.

Once the flag escort is at the present, the parade commander will order SLOPE—ARMS, and the parade, now including the flag party will slope arms.

Until the flag party is ordered off at the conclusion of the parade, it shall execute the parade commander's commands rather than the flag party commander's commands, except in the following circumstances:

- During an inspection, the flag shall remain in the carry position when the parade commander orders the corps AT—EASE.
- When required to move to a flank independently, the flag party shall do so under command of its flag party commander by executing forms at the halt or on the march.

MARCHING OFF THE FLAG(S)

On the command, MARCH OFF THE—FLAG(S), members of the flag party shall perform the following:

1. the flag party commander shall order the cautionary FLAG PARTY;
2. the parade commander shall order TO THE FLAG(S)—SALUTE; and
3. the flag party commander shall order BY THE RIGHT (CENTRE), QUICK—MARCH.

The series of forms shall be conducted as follows:

1. On the command FLAG PARTY, QUICK—MARCH, the flag party shall move as a unit to a location on the parade square centred on the parade commander.
2. On the command FLAG PARTY, CHANGE DIRECTION LEFT (RIGHT), LEFT (RIGHT)—FORM, the flag party shall perform a left (right) form on the march. Upon completion of the form, the cadets shall mark time.
3. The flag party shall resume marching on the command FOR—WARD.
4. The flag party shall move to the left (right) flank and march off the parade square.

CONFIRMATION OF TEACHING POINT 6

The cadets' participation in practicing marching on and off as members of a flag party will serve as the confirmation of this TP.

END OF LESSON CONFIRMATION

Have the cadets execute flag drill on the march while judging the time.

Continue delivering commands as time allows, focusing on movements with which the cadets experience difficulty.

CONCLUSION

HOMework/READING/PRACTICE

N/A.

METHOD OF EVALUATION

N/A.

CLOSING STATEMENT

Flag drill is the foundation for all other flag drill movements. Drill develops many qualities through self-discipline and practice. Drill that is well-rehearsed, closely supervised and precise is an exercise in obedience and alertness that creates teamwork.

INSTRUCTOR NOTES/REMARKS

It is recommended that this lesson be conducted in two separate sessions. Conduct TPs 1 to 4 in the first session and TPs 5 and 6 in the second session.

Corps wishing to deviate from the lesson structure for local/Regimental traditions may do so, but are limited to the six periods allocated.

REFERENCES

- A0-002 A-PD-201-000/PT-000 Director History and Heritage 3-2. (2005). *The Canadian Forces Manual of Drill and Ceremonial*. Ottawa, ON: Department of National Defence.
- A0-031 A-PD-202-001/FP-000 Director Ceremonial 2. (1993). *Canadian Forces Military Bands and Marches: Band Instructions*. Ottawa, ON: Department of National Defence.
- A0-099 A-AD-200-000/AG-000 Director History and Heritage. (1999). *The Honours, Flags and Heritage Structure of the Canadian Forces*. Ottawa, ON: Department of National Defence.
- A0-102 Director Cadets 5. (1999). CATO 12-05, *Cadet Flags and Banners*. Ottawa, ON: Department of National Defence.

THIS PAGE INTENTIONALLY LEFT BLANK



COMMON TRAINING
SILVER STAR
INSTRUCTIONAL GUIDE



SECTION 4

EO C308.02 – DELIVER WORDS OF COMMAND

Total Time:

60 min

PREPARATION

PRE-LESSON INSTRUCTIONS

Resources needed for the delivery of this lesson are listed in the lesson specification located in A-CR-CCP-703/PG-001, Chapter 4. Specific uses for said resources are identified throughout the instructional guide within the TP for which they are required.

Review the lesson content and become familiar with the material prior to delivering the lesson.

Photocopy, cut out, fold and laminate the aide-mémoire cards with the words of command located at Annex B for each cadet.

PRE-LESSON ASSIGNMENT

N/A.

APPROACH

A practical activity was chosen for this lesson as it is an interactive way to allow the cadets to experience delivering words of command in a safe, controlled environment.

INTRODUCTION

REVIEW

The review associated with this lesson is from EO M308.02 (Deliver Words of Command, Section 2), to include:

QUESTIONS

- Q1. Why are cautionary commands given?
- Q2. What is the purpose of the executive command?
- Q3. If a command is not pronounced clearly and distinctly, what affect may it have on the squad being commanded?
- Q4. How does poor posture affect delivering commands?

ANTICIPATED ANSWERS

- A1. To warn the squad that a movement will be performed.

- A2. To signal that the movement is to be carried out.
- A3. Cadets may not understand the command and perform the wrong movement.
- A4. It restricts the ability to breathe deeply, restricting the movement of the diaphragm, which will cause commands to come from the throat.

OBJECTIVES

By the end of this lesson the cadet shall have delivered words of command.

IMPORTANCE

It is important for cadets to know how to deliver words of command, as words of command that are delivered in a clear, concise manner, with confidence and determination, will affect how cadets respond to orders. Words of command are required to move a platoon in an organized and efficient manner.

Teaching Point 1

Demonstrate and Have the Cadets Practice Delivering Words of Command

Time: 50 min

Method: Practical Activity

ACTIVITY

OBJECTIVE

The objective of this activity is for each cadet to practice delivering words of command.

RESOURCES

Aide-mémoire cards located at Annex B.

ACTIVITY LAYOUT

N/A.

ACTIVITY INSTRUCTIONS

1. Demonstrate delivering words of command.
2. Distribute the aide-mémoire cards to each cadet.
3. Divide the cadets into groups of no more than four cadets.
4. Have each cadet, within their group, practice delivering words of command with emphasis on voice, accuracy, confidence, correct posture and breathing control. Have the cadets practice commands at the halt and on the march with the other members of the group acting as the squad. Each cadet will be allotted approximately 10 minutes in front of their group.
5. Circulate among the groups and assist the cadets as necessary, offering suggestions and advice for improvement.

SAFETY

N/A.

CONFIRMATION OF TEACHING POINT 1

The cadets' participation in the activity will serve as the confirmation of this TP.

END OF LESSON CONFIRMATION

The cadets' participation in delivering words of command will serve as the confirmation of this lesson.

CONCLUSION

HOMEWORK/READING/PRACTICE

N/A.

METHOD OF EVALUATION

N/A.

CLOSING STATEMENT

When words of command are delivered in a clear and concise manner and with confidence and determination, it will affect how cadets respond to the order. Delivering words of command can allow a platoon to move as a team in an organized and efficient manner as all members learn to work together.

INSTRUCTOR NOTES/REMARKS

Cadets shall be provided the opportunity to deliver words of command and be given feedback during weekly opening and closing parades, and ceremonial parades.

This EO will be used as additional practice time for EO M308.02 (Deliver Words of Command, Section 2).

REFERENCES

N/A.

THIS PAGE INTENTIONALLY LEFT BLANK

DRILL SEQUENCE HANDOUT (PREPARING A SQUAD FOR PARADE)

Squad in Line

When a squad is formed in line, the team leader, assuming the role of the PI WO, shall be positioned three paces in front and centred on the squad.

Steps to Preparing a Squad for Parade

The steps to preparing a squad for parade include:

1. The squad shall form up in three ranks at the edge of the parade square and stand at ease.
2. The team leader shall carry on with forming up a squad as detailed below.

Item	Command	Given By	Execution	Observation
a.		Team Leader	The Team Leader shall march to a position three paces in front of, and facing, the position the marker is to occupy.	The squad is formed up just off the parade square, standing easy. The right hand cadet of the front rank is the designated "Marker".
b.	MARKER	Team Leader	The Marker shall come to attention, answer by rank, observe the standard pause, march in a direct line to, and halt three paces in front of and facing, the Team Leader. The Marker shall remain at attention.	The platoon shall come to the position of stand at ease. The Team Leader, after placing the Marker, shall turn right and march to a position three paces in front of and centre facing where the squad shall fall in.
c.	Squad FALL—IN	Team Leader	The squad shall come to attention, observe the standard pause and march onto the parade ground. It shall halt on the left of and covering off the marker and remain at attention.	A direct route shall be taken by the squad.

3. The team leader shall carry on with calling the roll as detailed below.

Item	Command	Given By	Execution	Observation
a.	ANSWER TO YOUR NAME, STAND AT —EASE	Team Leader	Each squad member shall come to attention as their name is called, answer accordingly and stand at ease.	The team leader shall read each name from a roll and mark the attendance for each cadet.

4. The team leader shall carry on with sizing in a single rank and reforming threes (twos) as detailed below.

Item	Command	Given By	Execution	Observation
a.	TALLEST ON THE	Team Leader	The squad shall turn right, observe the standard pause, then arrange themselves	The team leader shall ensure the cadets are arranged as ordered before proceeding.

Item	Command	Given By	Execution	Observation
	RIGHT, SHORTEST ON THE LEFT, IN A SINGLE RANK— SIZE		according to height, with tallest on the right and shortest on the left in one single rank, shoulder to shoulder dressing and covering off front to rear.	
b.	SQUAD— NUMBER	Team Leader	The squad shall call out their number in sequence from the right.	The team leader shall ensure that no numbers are missed.
c.	ODD NUMBERS ONE PACE FORWARD, EVEN NUMBERS ONE PACE STEP BACK— MARCH	Team Leader	The squad shall act as ordered.	
d.	NUMBER ONE STAND FAST, ODD NUMBERS RIGHT, EVEN NUMBERS LEFT— TURN	Team Leader	The squad shall act as ordered.	
e.	REFORM THREES (TWOS), QUICK— MARCH	Team Leader	The squad reform ranks with Number 1 as the marker and remainder filling in the next open position.	When each person arrives in their new position, they shall halt, at arm's-length interval, observe the standard pause, turn left and remain at attention.

5. The team leader shall carry on with dressing a squad as detailed below.

Item	Command	Given By	Execution	Observation
a.	RIGHT— DRESS	Team Leader	The squad shall act as ordered.	
b.	EYES— FRONT	Team Leader	The squad shall act as ordered.	Squad members shall snap the head and eyes to the front, cut the right arm behind the cadet

Item	Command	Given By	Execution	Observation
				on the right and return to the position of attention.

6. The team leader shall carry on with inspecting a squad as detailed below.

Item	Command	Given By	Execution	Observation
a.	OPEN ORDER—MARCH	Team Leader	The squad shall act as ordered.	
b.	RIGHT—DRESS	Team Leader	The squad shall act as ordered.	
c.	EYES—FRONT	Team Leader	The squad shall act as ordered.	
d.		Team Leader	The team leader will inspect the front and rear of each cadet, starting at the right marker and proceeding around each rank in turn. The inspection of a cadet shall start at the head and work down to the feet.	The purpose of an inspection is to ensure a standard of personal hygiene and grooming, and that each cadet is properly dressed, with all clothing, badges, etc, are worn correctly, clean, and in good repair.
e.	CLOSE ORDER—MARCH	Team Leader	The squad shall act as ordered.	
f.	RIGHT—DRESS	Team Leader	The squad shall act as ordered.	
g.	EYES—FRONT	Team Leader	The squad shall act as ordered.	
h.	STAND AT—EASE	Team Leader	The squad shall act as ordered.	

7. As the platoon commander approaches, the team leader shall carry on with handing over a squad as detailed below.

Item	Command	Given By	Execution	Observation
a.	ATTENTION	Team Leader	The squad shall act as ordered.	The team leader calls the squad to attention as the platoon commander approaches.
b.		Team Leader		The platoon commander halts two paces in front of the team leader, who reports the squads strength and condition.

Item	Command	Given By	Execution	Observation
c.		Team Leader		Upon being ordered to fall in, the team leader turns right, by a series of wheels proceeds around the right flank and takes their position behind the squad.
d.		Platoon Commander		The platoon commander marches forward two paces to take up their position.

AIDE-MÉMOIRE CARD



PREPARING A SQUAD FOR PARADE	
FALLING IN: <ul style="list-style-type: none">• MARKER.• SQUAD FALL—IN.	DRESSING: <ul style="list-style-type: none">• RIGHT—DRESS.• EYES—FRONT.
CALLING THE ROLL: <ul style="list-style-type: none">• ANSWER TO YOUR NAME, STAND AT—EASE.	PRE-INSPECTING: <ul style="list-style-type: none">• OPEN ORDER—MARCH.• RIGHT—DRESS.• EYES—FRONT.
SIZING IN A SINGLE RANK: <ul style="list-style-type: none">• TALLEST ON THE RIGHT, SHORTEST ON THE LEFT, IN A SINGLE RANK—SIZE.• SQUAD—NUMBER.• ODD NUMBERS ONE PACE FORWARD, EVEN NUMBERS ONE PACE STEP BACK—MARCH.• NUMBER ONE STAND FAST, ODD NUMBERS RIGHT, EVEN NUMBERS LEFT—TURN.• REFORM THREES (TWOS), QUICK—MARCH.	POST-INSPECTING: <ul style="list-style-type: none">• CLOSE ORDER—MARCH.• RIGHT—DRESS.• EYES—FRONT.• STAND AT—EASE.
	HANDING OVER: <ul style="list-style-type: none">• ATTEN—TION.



PREPARING A SQUAD FOR PARADE	
FALLING IN: <ul style="list-style-type: none">• MARKER.• SQUAD FALL—IN.	DRESSING: <ul style="list-style-type: none">• RIGHT—DRESS.• EYES—FRONT.
CALLING THE ROLL: <ul style="list-style-type: none">• ANSWER TO YOUR NAME, STAND AT—EASE.	PRE-INSPECTING: <ul style="list-style-type: none">• OPEN ORDER—MARCH.• RIGHT—DRESS.• EYES—FRONT.
SIZING IN A SINGLE RANK: <ul style="list-style-type: none">• TALLEST ON THE RIGHT, SHORTEST ON THE LEFT, IN A SINGLE RANK—SIZE.• SQUAD—NUMBER.• ODD NUMBERS ONE PACE FORWARD, EVEN NUMBERS ONE PACE STEP BACK—MARCH.• NUMBER ONE STAND FAST, ODD NUMBERS RIGHT, EVEN NUMBERS LEFT—TURN.• REFORM THREES (TWOS), QUICK—MARCH.	POST-INSPECTING: <ul style="list-style-type: none">• CLOSE ORDER—MARCH.• RIGHT—DRESS.• EYES—FRONT.• STAND AT—EASE.
	HANDING OVER: <ul style="list-style-type: none">• ATTEN—TION.

THIS PAGE INTENTIONALLY LEFT BLANK

CHAPTER 9
PO 309 – INSTRUCT A LESSON



COMMON TRAINING
SILVER STAR
INSTRUCTIONAL GUIDE



SECTION 1

EO M309.01 – EXPLAIN THE PRINCIPLES OF INSTRUCTION

Total Time:

60 min

PREPARATION

PRE-LESSON INSTRUCTIONS

Resources needed for the delivery of this lesson are listed in the lesson specification located in A-CR-CCP-703/PG-001, Chapter 4. Specific uses for said resources are identified throughout the instructional guide within the TP for which they are required.

Review the lesson content and become familiar with the material prior to delivering the lesson.

The activity in TP 2 uses learning stations. Learning stations are a form of group work where the cadets learn by sorting through the information presented. When setting up learning stations, ensure there is enough room for each cadet to be comfortable and have adequate space for writing down information. When the cadets arrive at a learning station, all required information shall be available. These stations should be placed close together to minimize time for movement; however far enough apart to avoid interruptions from other groups. For this lesson, choose and set up six learning stations for the principles of instruction.

Photocopy the Principles of Instruction Information Sheets located at Annex A and the Principles of Instruction Worksheets located at Annex B for each station.

PRE-LESSON ASSIGNMENT

N/A.

APPROACH

An interactive lecture was chosen for TP 1 to present the principles of instruction and to generate interest.

An in-class activity was chosen for TP 2 as it is an interactive way for the cadets to apply the principles of instruction.

INTRODUCTION

REVIEW

N/A.

OBJECTIVES

By the end of this lesson the cadet shall have explained the principles of instruction and how they are applied when planning and instructing a lesson.

IMPORTANCE

It is important for the cadets to explain the principles of instruction and how they are applied when planning and instructing a lesson to make training enjoyable and successful and to help the instructor make informed decisions while in front of a class. The ability to keep a class interested, motivated and eager to learn are invaluable skills that will provide a positive learning experience for the cadets.

Teaching Point 1

Describe the Principles of Instruction

Time: 10 min

Method: Interactive Lecture

THE PRINCIPLES OF INSTRUCTION



Principle. A fundamental truth or law as the basis of reasoning or action.

In order to create an environment that promotes participation and learning, an instructor follows a set of guidelines or principles to plan and instruct a lesson. The following are the fundamental guidelines known as the principles of instruction:

- **Interest.** Cadets are more receptive to learning when they are curious and have an emotional connection to a topic. The instructor must arouse, create and maintain the interest of the cadets. Without interest, the cadets will be less inclined to listen and will not learn.
- **Comprehension.** Comprehension or understanding relates to the cadet's ability to understand the material taught. The cadets' readiness to learn new material is influenced by what has previously been taught; new content should not exceed the knowledge level of the cadets. If the cadets do not understand, they are unable to learn.
- **Emphasis.** During a period of instruction, there will be some information that may be of particular importance. The instructor can emphasize this important information through the use of voice control, training aids and in-class activities.
- **Participation.** Cadets are more likely to retain information if they are both mentally and physically involved in learning. The instructor should conduct activities that contain action, activity and excitement. Cadets learn by doing.
- **Accomplishment.** The lesson must impart a sense of accomplishment to each cadet. The cadets should leave the class with the satisfaction that they were able to accomplish something in the lesson.
- **Confirmation.** Confirmation is an essential part of learning and instructing. It gives both the instructor and the cadet the opportunity to see how well the information is understood.



The acronym ICEPAC is useful for remembering the principles of instruction.

CONFIRMATION OF TEACHING POINT 1

QUESTIONS

Q1. List the principles of instruction.

Q2. What will occur if a lesson lacks interest?

Q3. What is the acronym that can be used to remember the principles of instruction?

ANTICIPATED ANSWERS

A1. The principles of instruction are:

- interest,
- comprehension,
- emphasis,
- participation,
- accomplishment, and
- confirmation.

A2. Without interest the cadets will be less inclined to listen and will not learn.

A3. The acronym that can be used to remember the principles of instruction is ICEPAC.

Teaching Point 2

Conduct an Activity Where the Cadets Will Apply the Principles of Instruction

Time: 40 min

Method: In-Class Activity

ACTIVITY

OBJECTIVE

The objective of this activity is to have the cadets practice the application of the principles of instruction.

RESOURCES

- Principles of instruction information sheets,
- Principles of instruction worksheets, and
- Pens/pencils.

ACTIVITY LAYOUT

Set up six learning stations, to include:

- principles of instruction information sheets,
- principles of instruction worksheets, and
- pens/pencils.

ACTIVITY INSTRUCTIONS

1. Divide the cadets into six groups and place each group at one of the principles of instruction learning stations.
2. Assign each group a leader. Have the group leader assign a recorder and a reader.

- Using the principle and topic at the top of the page, have the groups fill out the principle of instruction worksheet (it is necessary for each group to fill out only one worksheet).
- After five minutes, have the groups rotate clockwise to the next station. Have the cadets complete the next principle of instruction worksheet.



Have the groups bring their worksheets with them as they rotate through the stations.



It is important to circulate around the room to facilitate the activities and help the cadets as required. If possible, assign other instructors to aid with supervision and facilitation.

- Rotate the groups through the remaining stations.
- Have the cadets share the information they recorded with the rest of the cadets. In most cases the groups will have recorded the same information for each station. If a group has listed different information it will be shared after the presentation is finished.

SAFETY

N/A.

CONFIRMATION OF TEACHING POINT 2

The cadets' participation in the activity will serve as the confirmation of this TP.

END OF LESSON CONFIRMATION

The cadets' participation in the principles of instruction learning stations will serve as the confirmation of this lesson.

CONCLUSION

HOMEWORK/READING/PRACTICE

N/A.

METHOD OF EVALUATION

N/A.

CLOSING STATEMENT

Describing the principles of instruction and knowing how to apply them when planning and instructing a lesson assists in making training enjoyable and successful and helps the instructor make informed decisions while in front of a class. The ability to keep a class interested, motivated and eager to learn are invaluable skills that will provide a positive learning experience.

INSTRUCTOR NOTES/REMARKS

The learning stations must be set up prior to beginning this lesson.

The cadets will be divided into six groups and will rotate through the stations during the in-class activity in TP 2.

REFERENCES

A0-055 A-P9-050-000/PT-006 Canadian Forces Individual Training and Education System. (1997). *Conduct of Instructional Programmes* (Vol. 6). Ottawa, ON: Department of National Defence.

THIS PAGE INTENTIONALLY LEFT BLANK



COMMON TRAINING
SILVER STAR
INSTRUCTIONAL GUIDE



SECTION 2

EO M309.02 – IDENTIFY METHODS OF INSTRUCTION

Total Time:

60 min

PREPARATION

PRE-LESSON INSTRUCTIONS

Resources needed for the delivery of this lesson are listed in the lesson specification located in A-CR-CCP-703/PG-001, Chapter 4. Specific uses for said resources are identified throughout the instructional guide within the TP for which they are required.

Review the lesson content and become familiar with the material prior to delivering the lesson.

Photocopy Annexes C and D for each cadet.

PRE-LESSON ASSIGNMENT

N/A.

APPROACH

An interactive lecture was chosen for TP 1 to describe types of lessons as it allows the instructor to deliver new information while encouraging the cadets to actively participate by asking and responding to questions.

An in-class activity was chosen for TPs 2 and 3 as it is an interactive way to reinforce the topic and confirm the cadets' comprehension of types of lessons and methods of instruction.

INTRODUCTION

REVIEW

N/A

OBJECTIVES

By the end of this lesson the cadet shall have identified a method of instruction appropriate for a specific type of lesson and given topic.

IMPORTANCE

It is important for cadets to know that there are many methods of instruction that can be used for knowledge and skill lessons. Varying the method of instruction is one way for instructors to create interest and encourage learning.

Teaching Point 1**Describe Types of Lessons**

Time: 5 min

Method: Interactive Lecture

TYPES OF LESSONS

Knowledge and skill are the two types of lessons.



The main differences between a knowledge lesson and a skill lesson are how the cadets participate during the lesson and how the instructor confirms learning at the end of a teaching point or lesson.

In a knowledge lesson, the cadets participate by asking and responding to questions and discussing lesson content. The instructor confirms learning by posing questions to the class or conducting an activity.

In a skill lesson, the cadets participate by practicing and performing a skill while the instructor observes the cadets' performance to confirm learning.

Knowledge Lesson

A knowledge lesson gives the cadets the theoretical aspects of a subject. The instructor presents basic information about a topic, typically following the who, what, where, when and why (5 Ws) format. Delivering an effective knowledge lesson requires the instructor to:

1. select an instructional method;
2. research the lesson information thoroughly;
3. summarize the information;
4. prepare questions to encourage class participation;
5. prepare questions for confirmation; and
6. prepare training aids.



All lessons require the instructor to create and maintain interest. It is especially important that instructors ensure that knowledge lessons are interesting because they are not hands-on.

Skill Lesson

A skill lesson demonstrates the skill to be learned in a step-by-step sequence. Conducting an effective demonstration requires the instructor to:

1. plan carefully;
2. breakdown the skill to be taught into sequential steps;
3. rehearse the sequence to ensure that it is accurate and clear;
4. prepare a written lesson plan;
5. prepare and/or obtain all material needed to demonstrate and practice the skill in advance;

6. organize the class so the demonstration can be seen;
7. allow the cadets to practice the steps under supervision;
8. provide assistance or re-demonstrate as necessary; and
9. allow the cadets to continue to practice under supervision until all have achieved the skill.



Mastery of a particular skill may require practice beyond class time depending upon the learners and difficulty of the skill.



Learning is a combination of knowledge, attitudes and skills that promote the development of a cadet.

CONFIRMATION OF TEACHING POINT 1

QUESTIONS

- Q1. What are the main differences between knowledge and skill lessons?
- Q2. How do instructors confirm learning in a skill lesson?
- Q3. Why is it more difficult to create and maintain interest in a knowledge lesson?

ANTICIPATED ANSWERS

- A1. Knowledge and skill lessons differ mainly in how cadets participate during the lesson and how instructors confirm learning at the end of a teaching point or lesson.
- A2. Instructors confirm learning in a skill lesson by observing the cadets perform the skill.
- A3. It is more difficult to create and maintain interest in a knowledge lesson because it is not hands-on.

Teaching Point 2

Conduct an Activity Where the Cadets Will Describe Methods of Instruction

Time: 25 min

Method: In-Class Activity

BACKGROUND KNOWLEDGE

INSTRUCTIONAL METHODS

Instructors should be familiar with and able to use a variety of methods of instruction. Some of the more widely used instructional methods are described and located at Annex C.

ACTIVITY

OBJECTIVE

The objective of this activity is to have the cadets describe methods of instruction.

RESOURCES

- Methods of instruction information sheets,
- Flip chart paper,
- Coloured markers, and
- Pens/pencils.

ACTIVITY LAYOUT

Set up four work stations and label them “description”, “pre-lesson preparation”, “typical applications” and “lesson development”. At each station have:

- three sheets of flip chart paper, and
- coloured markers.

ACTIVITY INSTRUCTIONS

1. Divide the cadets into four groups and place each group at one of the labelled work stations.
2. Give the cadets a copy of Annex C.
3. Assign each group a leader. The group leader will be responsible for assigning a recorder and reader.
4. Have each group research their information (description, pre-lesson preparation, typical applications, or lesson development) from Annex C for each method of instruction and record the key points on the flip chart paper. (10 minutes)
5. Have the groups share their information with the class. (10 minutes)

SAFETY

N/A.

CONFIRMATION OF TEACHING POINT 2

The cadets’ participation in the activity will serve as the confirmation of this TP.

Teaching Point 3**Conduct an Activity Where the Cadets Will Select an Appropriate Method of Instruction for a Given Topic**

Time: 20 min

Method: In-Class Activity



The instructional method is determined by the:

- lesson material,
- environment in which the training will take place,
- resources available to the instructor,
- time available to the instructor, and
- needs of the cadets.

ACTIVITY**OBJECTIVE**

The objective of this activity is to have the cadets consider criteria and select an appropriate method of instruction for each topic.

RESOURCES

List of lesson topics located at Annex D.

ACTIVITY LAYOUT

N/A.

ACTIVITY INSTRUCTIONS

1. Give the cadets a copy of Annex D.
2. Introduce the objective of the activity and have the cadets work individually for 10 minutes matching the lesson topics to the instructional methods described in TP 2.
3. Stress that some topics can be taught using more than one method of instruction but they are to choose the one they consider to be the most appropriate.
4. Have the cadets share their work with the class by identifying and explaining their choice of instructional method for a topic.



No single instructional method is best for all objectives. Providing instruction using a variety of methods can often enhance learning.

SAFETY

N/A.

CONFIRMATION OF TEACHING POINT 3

The cadets' participation in the activity will serve as the confirmation of this TP.

END OF LESSON CONFIRMATION

QUESTIONS

- Q1. What is one application of the interactive lecture?
- Q2. How does the instructor confirm learning when using the demonstration and performance instructional method?
- Q3. What instructional method is being used when the cadets participate in "real life" operations that illustrate what was discussed or learned in the classroom?
- Q4. Give two examples of in-class activities?
- Q5. Games create variety and arouse interest. It is critical they do what?
- Q6. Which instructional method is being used when cadets produce a product, carry out an application or demonstrate a process?

ANTICIPATED ANSWERS

- A1. Interactive lectures can be used to review previously taught material, present background information, introduce a new subject, give instructions on procedures, illustrate the application of rules, principles or concepts and introduce a demonstration, discussion or performance.
- A2. During a demonstration and performance, the instructor confirms learning by observing the cadet perform the operation, skill or movement.
- A3. Field trip.
- A4. In-class activities include learning stations, videos, brainstorming, debating and group work.
- A5. It is critical that games support learning.
- A6. Practical activity.

CONCLUSION

HOMEWORK/READING/PRACTICE

N/A.

METHOD OF EVALUATION

This EO is assessed IAW A-CR-CCP-703/PG-001, Chapter 3, Annex B, Appendix 3 (309 PC).

CLOSING STATEMENT

Being able to select a method of instruction appropriate for a given lesson is an important skill for an instructor. Cadets will be more likely to pay attention, participate in classroom activities, answer questions and generally have a positive learning experience if instructors select an appropriate instructional method and plan the learning activities.

INSTRUCTOR NOTES/REMARKS

N/A.

REFERENCES

- A0-055 A-P9-050-000/PT-006 Director Training and Education Policy. (2002). *Canadian Forces Individual Training and Education System* (Vol. 6). Ottawa, ON: Department of National Defence.
- A0-056 A-P9-050-000/PT-005 Director Training and Education Policy. (2001). *Canadian Forces Individual Training and Education System* (Vol. 5). Ottawa, ON: Department of National Defence.

THIS PAGE INTENTIONALLY LEFT BLANK



COMMON TRAINING
SILVER STAR
INSTRUCTIONAL GUIDE



SECTION 3

EO M309.03 – DESCRIBE EFFECTIVE-SPEAKING TECHNIQUES

Total Time:

30 min

PREPARATION

PRE-LESSON INSTRUCTIONS

Resources needed for the delivery of this lesson are listed in the lesson specification located in A-CR-CCP-703/PG-001, Chapter 4. Specific uses for said resources are identified throughout the instructional guide within the TP for which they are required.

Review the lesson content and become familiar with the material prior to delivering the lesson.

PRE-LESSON ASSIGNMENT

N/A.

APPROACH

An interactive lecture was chosen for TPs 1 and 3 to present basic material and to orient the cadets to aspects of voice control and how to prepare for effective-speaking.

A group discussion was chosen for TP 2 as it allows the cadets to interact with their peers and share their knowledge, experiences, opinions and feelings about physical presence while speaking in front of a group.

INTRODUCTION

REVIEW

N/A.

OBJECTIVES

By the end of this lesson the cadet shall have described elements of voice control, elements of physical presence and effective-speaking preparation.

IMPORTANCE

It is important for the cadets to describe elements of voice control and physical presence to be a confident instructor. The ability to effectively prepare for a presentation and control nervousness are invaluable skills that help to provide a positive learning experience for both the instructor and the trainee.

Teaching Point 1**Explain Elements of Voice Control**

Time: 10 min

Method: Interactive Lecture



The cadets may have been exposed to people from other communities, provinces and even countries with accents different from their own. Brainstorm with the cadets how elements of voice control can affect how the message is received and write down the responses. After the brainstorming is complete, compare the class list to the list below.

ELEMENTS OF VOICE CONTROL

One of the most important and effective tools of communication is voice control. The ability to use voice control to communicate effectively and place emphasis on important information is a fundamental skill that will be used while in front of an audience.

Pitch. How high or low a voice is. A change in pitch usually does not add any significance to a message. However, a pitch change will be noticed by the audience and will keep people involved.

Tone. The quality of the sound of a voice. Effective communicators will often change the tone of their voice to give emphasis to a single word or phrase to convey emotion and conviction.



Monotone. A sound without change of pitch or tone.

Volume. The quantity or power of sound or fullness of tone. A change in volume often signifies emphasis on a particular phrase or point. Environmental factors such as outside noise and room size must be taken into consideration to ensure the audience can hear the message being sent.

Speed. The rate or rapidity in which words are spoken. Speaking too fast or too slow can be distracting to an audience. It is important to communicate at a pace that ensures the audience can understand every word being said.

Pause. A break in speaking or reading. A pause is an important part of the communication process. A pause gives the audience an opportunity to digest what has been said and to ask questions. A pause is also an effective way to announce a change in subject or an important point.

Articulation. The clear and distinct pronunciation of a word. It is important to properly pronounce and articulate words to ensure the audience can understand the message being sent.

CONFIRMATION OF TEACHING POINT 1

QUESTIONS

- Q1. Name the six elements of voice control.
- Q2. What can a change in volume signify when sending a message?
- Q3. What is the purpose of pausing while speaking?

ANTICIPATED ANSWERS

- A1. The six elements of voice control are:

- pitch,
- tone,
- volume,
- speed,
- pause, and
- articulation.

A2. A change in volume can signify emphasis on a particular phrase or point.

A3. A pause gives the audience an opportunity to digest what has been said and to ask questions. A pause is also an effective way to announce a change in subject or an important point.

Teaching Point 2

Discuss Elements of Physical Presence

Time: 10 min

Method: Group Discussion

BACKGROUND KNOWLEDGE



The purpose of the group discussion is to draw the following information from the group using the tips for answering/facilitating discussion and the suggested questions provided.

ELEMENTS OF PHYSICAL PRESENCE

It is estimated that 93 percent of the total meaning of a message comes from non-verbal communication and only 7 percent of meaning comes from the words themselves. Being aware of physical presence and its effect on a message being sent is an important element of effective communication.

Body Language

Body language or non-verbal communication is the process of communicating through conscious and unconscious gestures and expressions. Understanding that body language affects how a message is received and interpreted is an important tool for communicating effectively.

Facial Expressions. While 93 percent of the total meaning of a message comes from non-verbal communication, most of that meaning is communicated by the eyes, eyebrows and mouth. The movement of the eyes, eyebrows and mouth can result in an infinite variety of expressions to complement the spoken word. It is important that facial expressions match the tone of the message being sent to create emphasis and believability. A smile is the most important of all facial expressions. A smile adds sincerity to a message and will add to the likeability of the individual in front of the audience.

Eye Contact. Maintaining eye contact is an effective way of engaging an audience and building interest. Pausing two or three seconds on each member of the audience will make them feel as though they are involved in a one-on-one conversation. It is important to look at the entire room and scan from left to right, back to front.

Gestures. The combination of hand, arm and shoulder movements can make a wide variety of gestures that can help add meaning to a message. Effective communicators will let their hands and arms move naturally to

help give emphasis and emotion to a message. It is important not to point directly at members of the audience or let gestures become distracting.

Movement. Being aware of movement while in front of an audience is very important to communication. Movement will keep listeners engaged and interested in what is being said. Moving around the front of the room, toward and away from an audience and from side to side can help emphasize points. Too much or frantic movement can become distracting and will affect how a message is received.



Hands placed in pockets are typically a sign of nervousness or overconfidence.

Dress and Deportment

Effective communicators are aware of their dress and deportment. Audiences will react differently to an individual who is well dressed and acts professionally, than an individual who is poorly dressed and acts unprofessionally.

Dress. Effective communicators will always appear in clean, well-pressed and appropriate attire. Dressing appropriately for the event will help create confidence and credibility.

Deportment. An audience that sees an individual as being prepared, on time, appropriately dressed and confident will be much more receptive, than to an individual who is unprepared, late, poorly dressed and nervous. The most important element of deportment is displaying an interest in the subject; this will be noticed by the audience and will generate interest in the presentation.

GROUP DISCUSSION



TIPS FOR ANSWERING/FACILITATING DISCUSSION

- Establish ground rules for discussion, eg, everyone should listen respectfully; don't interrupt; only one person speaks at a time; no one's ideas should be made fun of; you can disagree with ideas but not with the person; try to understand others as much as you hope they understand you; etc.
- Sit the group in a circle, making sure all cadets can be seen by everyone else.
- Ask questions that will provoke thought; in other words avoid questions with yes or no answers.
- Manage time by ensuring the cadets stay on topic.
- Listen and respond in a way that indicates you have heard and understood the cadet. This can be done by paraphrasing their ideas.
- Give the cadets time to respond to your questions.
- Ensure every cadet has an opportunity to participate. One option is to go around the group and have each cadet answer the question with a short answer. Cadets must also have the option to pass if they wish.
- Additional questions should be prepared ahead of time.

SUGGESTED QUESTIONS

- Q1. How could you use facial expressions to emphasize something that is funny?
- Q2. As an effective-speaker how could you make the audience feel like they are part of the presentation?

Q3. How would you expect an instructor to present themselves in terms of dress and deportment?

Q4. What is one of the most important elements of deportment?



Other questions and answers will develop throughout the group discussion. The group discussion should not be limited to only those suggested.



Reinforce the answers given and comments made during the group discussion, ensuring the teaching point has been covered.

CONFIRMATION OF TEACHING POINT 2

The cadets' participation in the group discussion will serve as the confirmation of this TP.

Teaching Point 3

Explain Effective-Speaking Preparation

Time: 5 min

Method: Interactive Lecture

Effective-speaking preparation is the most critical component of effective communication. Preparation will help to ensure confidence, control nervousness and increase the likelihood of success when in front of an audience.

The following are the steps to effective-speaking preparation:

1. **Practicing.** Proper rehearsal will aid in memorizing content, which will allow for more eye contact and movement while in front of an audience. Memorizing the introduction and conclusion are the two most critical elements; a strong introduction will aid in gaining confidence and will draw the interest of the audience, a strong conclusion will aid in leaving a lasting impression on the audience. If possible, practice in front of a small group, speak aloud even when practicing alone and always practice while standing.
2. **Controlling Nervousness.** The feeling of nervousness prior to speaking in front of a group is normal and often can help if channeled effectively. The following actions can be taken to control nervousness:
 - a. **Room Layout.** Become familiar with the layout of the room prior to speaking.
 - b. **Materials.** Ensure notes, handouts and presentation aids are organized.
 - c. **Equipment.** Ensure any equipment being used is in working order and ready to use.
 - d. **Practice.** Spend time going over notes and rehearsing content.
 - e. **Attitude.** Enter the room with a smile and a positive and confident attitude.
 - f. **Breathing.** Take a deep breath before entering the room. Slow down the delivery if necessary and breathe from the diaphragm while speaking, not from the chest.
3. **Identifying a Friendly Face.** While walking in front of an audience, identify a friendly face. Making eye contact with a friendly face while beginning to speak will often give confidence while beginning the introduction and ultimately lead to success when addressing an audience.

CONFIRMATION OF TEACHING POINT 3

QUESTIONS

- Q1. What are the three steps to effective-speaking preparation?
- Q2. What actions can be taken to control nervousness?
- Q3. What is the benefit of identifying a friendly face?

ANTICIPATED ANSWERS

- A1. The three steps to effective-speaking preparation are:
1. practice,
 2. control nervousness, and
 3. identify a friendly face.
- A2. The actions that can be taken to control nervousness are:
- become familiar with the layout of the room prior to speaking,
 - ensure notes, handouts and presentation aids are well organized,
 - ensure any equipment being used is in working order and ready to use,
 - spend time going over notes and rehearse content,
 - enter the room with a smile and a positive and confident attitude, and
 - take a deep breath before entering the room.
- A3. Making eye contact with a friendly face while beginning to speak will often give confidence while beginning the introduction and ultimately lead to success when addressing an audience.

END OF LESSON CONFIRMATION

QUESTIONS

- Q1. What is meant by tone?
- Q2. What are the two elements of physical presence?
- Q3. What are the four aspects of body language?

ANTICIPATED ANSWERS

- A1. The quality of the sound of a voice.
- A2. The two elements of physical presence are:
- body language, and
 - dress and deportment.
- A3. The four aspects of body language are:

- facial expressions,
- eye contact,
- gestures, and
- movement.

CONCLUSION

HOMEWORK/READING/PRACTICE

N/A.

METHOD OF EVALUATION

N/A.

CLOSING STATEMENT

Knowing how to apply elements of voice control and physical presence will make instructing enjoyable and successful by helping develop presence while in front of an audience. The ability to effectively prepare for a presentation and control nervousness are invaluable skills that may help to develop a more confident instructor.

INSTRUCTOR NOTES/REMARKS

N/A.

REFERENCES

C0-192 (ISBN 0-9695066-2-7) Bender, P. (2000). *Secrets of Power Presentations*. Toronto, ON: The Achievement Group.

THIS PAGE INTENTIONALLY LEFT BLANK



COMMON TRAINING
SILVER STAR
INSTRUCTIONAL GUIDE



SECTION 4

EO M309.04 – DESCRIBE QUESTIONING TECHNIQUES

Total Time:

30 min

PREPARATION

PRE-LESSON INSTRUCTIONS

Resources needed for the delivery of this lesson are listed in the lesson specification located in A-CR-CCP-703/PG-001, Chapter 4. Specific uses for said resources are identified throughout the instructional guide within the TP for which they are required.

Review the lesson content and become familiar with the material prior to delivering the lesson.

Arrange for officers or senior cadets to assist in conducting the activity and recording data regarding the cadets' performance.

Review the activity instructions with the officers and senior cadets assisting with the activity.

Photocopy Annexes E, F, G and H for the officers and senior cadets assisting with the activity.

Photocopy Annex E for each cadet.

Assign spaces in the training area for workstations to conduct the activity if more than one group is used.

Make photocopies of Annex F for each station if necessary.

PRE-LESSON ASSIGNMENT

N/A.

APPROACH

An interactive lecture was chosen for TPs 1–3 as it allows the instructor to describe the purposes, qualities and types of questions while encouraging the cadets to actively participate by asking and responding to questions.

An in-class activity was chosen for TP 4 as it is an interactive way to reinforce the topic and confirm the cadets' comprehension of questioning techniques.

INTRODUCTION

REVIEW

N/A.

OBJECTIVES

By the end of this lesson the cadet shall have described questioning techniques by listing the purposes of questioning, listing the qualities of a good question, defining types of questions and by listing the steps to posing questions while instructing.

IMPORTANCE

Asking questions throughout a lesson helps the instructor to determine the cadets' level of comprehension of previously taught material, to create interest in the lesson and to confirm the cadets' comprehension of new material. Proper questioning techniques will help instructors ask questions properly to accomplish these goals and to develop confidence in their instructional abilities.

Teaching Point 1

Describe the Purposes of Questioning

Time: 5 min

Method: Interactive Lecture

PURPOSES OF QUESTIONING

Questions that are carefully developed and incorporated into a lesson plan may improve learning. In fact, instructors' use of questions has such an impact on learning that it can be considered an indicator of their overall effectiveness. Instructors may improve their questioning technique by carefully planning what questions to ask, when and how to ask them so as to improve their instructional ability.

Questions can be posed throughout a lesson to:

- determine the cadets' level of comprehension of previously taught related material;
- create and maintain interest by keeping the cadets mentally alert and making them feel more involved in the lesson;
- guide and provoke thinking by carefully selecting questions and following answers with other questions as the lesson progresses; and
- confirm learning, especially for knowledge lessons, by asking questions at the end of each TP and at the end of the lesson.

CONFIRMATION OF TEACHING POINT 1

QUESTIONS

- Q1. Why is questioning such an important aspect of instruction?
- Q2. How can instructors improve their questioning technique?
- Q3. What are four purposes of questioning?

ANTICIPATED ANSWERS

- A1. Questioning has a big impact on learning and is considered an indicator of an instructor's effectiveness.
- A2. By planning what questions to ask and when and how to ask them.
- A3. To determine comprehension of previously learned material, create and maintain interest, guide and provoke thinking, and to confirm learning.

Teaching Point 2**Describe the Qualities of a Good Question**

Time: 5 min

Method: Interactive Lecture

QUALITIES OF A GOOD QUESTION

Questions used during a lesson should be written out ahead of time. Instructors who consistently pay attention to writing good quality questions will improve their instruction and learn to instinctively phrase good questions when the situation demands it during a lesson.



Often the cadets who are being instructed ask questions for clarification. Effective instructors create a classroom atmosphere that encourages cadets to ask questions, which are relevant to the lesson.

The exact wording of a question is determined by its purpose and the situation in which it is asked. While the wording may vary, all questions should be:

- brief, complete and easily understood;
- stated clearly using simple language;
- a challenge to cadets to apply their knowledge;
- not so difficult that only a few cadets can answer; and
- relevant to the lesson by reinforcing and supporting the teaching points.

CONFIRMATION OF TEACHING POINT 2

QUESTIONS

- Q1. Why should questions be written out ahead of time?
- Q2. How can instructors learn to ask better quality questions while instructing?
- Q3. What are five qualities of good questions?

ANTICIPATED ANSWERS

- A1. Questions written out ahead of time are of better quality and will improve instruction.
- A2. By crafting good quality questions, the question-making process will become instinctive.
- A3. Brief and complete, clearly stated, challenging, not too difficult, and relevant.

Teaching Point 3**Describe Types of Questions**

Time: 5 min

Method: Interactive Lecture



All questions may be categorized as either participatory or evaluative. Participatory questions are used during a lesson to create and maintain interest, to keep cadets mentally alert and to guide thought. Evaluative questions are used at the beginning of a lesson to determine retention of previously taught material or at the end of a TP or lesson to confirm comprehension of new material.

There are many types of questions but those most commonly recognized include:

Lead-Off. Questions, which are used to begin a lecture or start a discussion. This type of question does not necessarily require a verbal or written response and is designed to get the cadets thinking about the topic of the lesson or the issue being discussed.

Example: “What does being a good cadet mean to you?”

Follow-Up. Questions that are used to further stimulate the cadets’ thinking about the topic of the lesson or point of discussion. As the name suggests they are supplementary questions related to the initial lead-off question or are questions, which are phrased on the spot to probe an answer to a previous question or extend a point of discussion.

Example: “Identify an item, just mentioned in question one, that can be considered both a good and bad cadet quality.”

Overhead. Questions that are asked to the whole group without indicating who is to reply. There will be several answers to this type of question and everyone should be given a chance to respond.

Example: “Identify one factor that can determine if a cadet quality is good or bad”

Direct. Questions that are the opposite of overhead questions because someone is directed to answer. These questions can be used to draw in those who are reluctant to take part in discussions, to prompt cadets who are inattentive or to get a discussion back on track.

Example: “Cadet I.M. Reluctant, can you think of another factor which determines if a cadet quality is good or bad?”

Reverse or Relay. Questions are used to keep the discussion in the hands of the cadets. Instead of answering a question posed by a cadet the instructor can reverse the question and return it to the person who asked it or relay it to another member of the class.

Example: “Cadet C. Legs, can you answer Cadet I.M. Reluctant’s question?”



Never use reverse or relay as an escape mechanism for questions you cannot answer. Always admit that you don’t know the answer and follow up later rather than use reverse and relay.

CONFIRMATION OF TEACHING POINT 3

QUESTIONS

Q1. Which type of question does not necessarily require a response?

Q2. Which type of question can be used to encourage cadets to take part in a discussion?

Q3. What is one thing to avoid when using reverse and relay questions?

ANTICIPATED ANSWERS

A1. Lead-off.

A2. Direct.

A3. Trying to hide the fact that an instructor doesn't know the answer to a question.

Teaching Point 4

Conduct an Activity Where the Cadets Will Practice Posing Questions Using the Pose, Pause, Pounce, Ponder and Praise Sequence

Time: 10 min

Method: In-Class Activity

ACTIVITY

OBJECTIVE

The objective of this activity is to introduce cadets to a posing questions sequence that they can follow when asking questions while instructing, particularly during M309.07 (Instruct a 15-Minute Lesson, Section 7).

RESOURCES

- Posing questions sequence handout located at Annex E,
- Questions handout located at Annex F,
- Posing questions rubric located at Annex G, and
- Posing questions checklist located at Annex H.

ACTIVITY LAYOUT

Set up work stations, if necessary, labelled A, B, C, etc. and place the following at each station:

- a copy of the posing questions sequence handout,
- a copy of the questions, and
- pens/pencils.



If possible brief the assisting staff and the cadets prior to the lesson.



The activity can be used with one group of five to ten cadets or several smaller groups if numbers warrant. The objective is to have each cadet follow the question posing sequence for at least one question but they can ask more than one if necessary. If the group is larger than five other questions can be devised using the children's story, "Goldilocks and the Three Bears."

ACTIVITY INSTRUCTIONS

Divide cadets into groups, if necessary, and assign a supervisor and letter name to each group.

1. Brief the assisting staff that they will be expected to:
 - a. assign each cadet in their group a number from one to five indicating the order in which they will take part in the activity;
 - b. move their groups to the appropriately named area to conduct the activity;
 - c. read the introduction to the children's story, "Goldilocks and the Three Bears" to the cadets;
 - d. ask Cadet # 1 to pose the first question from Annex F and record information on the checklist describing their performance;
 - e. carry out the same procedure for each succeeding cadet;
 - f. provide feedback to each cadet regarding their performance;
 - g. return the group to the main area; and
 - h. give the completed posing questions checklist to the instructor.
2. Ensure that assisting staff have a copy of Annexes E to H.
3. Brief the cadets that they will:
 - a. listen to a short introduction to the children's story, "Goldilocks and the Three Bears";
 - b. use a question posing sequence to ask one question to their group based on the children's story, "Goldilocks and the Three Bears"; and
 - c. be supervised and corrected on the spot if they do not follow the posing questions sequence properly.
4. Have the cadets begin the activity.
5. Circulate throughout the training area observing the groups as they take part in the activity.
6. Debrief the cadets on their performance.



Remind cadets that the activity was designed to introduce a posing questions sequence that they can follow when asking questions while instructing, particularly during M309.07 (Instruct a 15-Minute Lesson, Section 7).

SAFETY

N/A.

CONFIRMATION OF TEACHING POINT 4

The cadets' participation in the activity will serve as the confirmation of this TP.

END OF LESSON CONFIRMATION

QUESTIONS

- Q1. What are the four purposes for asking questions?
- Q2. List two qualities of a good question.
- Q3. List two types of questions most commonly recognized.
- Q4. List the five parts of the question posing sequence.

ANTICIPATED ANSWERS

- A1. The four purposes of questions are:
- to determine the cadets' level of comprehension of previously taught material;
 - to create and maintain interest;
 - to guide and provoke thinking; and
 - to confirm learning of new material.
- A2. Good questions should be brief and complete, written clearly using simple language, challenging, not too difficult and relevant to the lesson.
- A3. The types of questions most commonly recognized are lead-off questions, follow-up questions, overhead questions, direct questions and reverse or relay questions.
- A4. The five parts of the question posing sequence are pose, pause, point, ponder and praise.
-

CONCLUSION

HOMEWORK/READING/PRACTICE

N/A.

METHOD OF EVALUATION

N/A.

CLOSING STATEMENT

The question is an important tool for the instructor. It is useful for instructors to know the purposes, qualities and types of questions but should keep in mind that this knowledge alone will not necessarily improve questioning technique. Carefully writing out questions before hand and asking them properly are just as important when using questions while instructing a lesson.

INSTRUCTOR NOTES/REMARKS

N/A.

REFERENCES

- A0-055 A-P9-050-000/PT-006 Director Training and Education Policy. (2002). *Canadian Forces Individual Training and Education System* (Vol. 6). Ottawa, ON: Department of National Defence.
- A0-056 A-P9-050-000/PT-005 Director Training and Education Policy. (2001). *Canadian Forces Individual Training and Education System* (Vol. 5). Ottawa, ON: Department of National Defence.
- A0-057 A-CR-CCP-913/PT-001 Cadet Instructors List Training School. (1978). *Technique of Instruction*. Ottawa, ON: Department of National Defence.



COMMON TRAINING
SILVER STAR
INSTRUCTIONAL GUIDE



SECTION 5

EO M309.05 – SELECT APPROPRIATE INSTRUCTIONAL AIDS

Total Time:

60 min

PREPARATION

PRE-LESSON INSTRUCTIONS

Resources needed for the delivery of this lesson are listed in the lesson specification located in A-CR-CCP-703/PG-001, Chapter 4. Specific uses for said resources are identified throughout the instructional guide within the TP for which they are required.

Review the lesson content and become familiar with the material prior to delivering the lesson.

The activity in TP 2 uses learning stations. Learning stations are a form of group work where the cadets learn by sorting through the information presented. When setting up learning stations, ensure there is enough room for each cadet to be comfortable and have adequate space for writing down information. When the cadets arrive at a learning station, all required information shall be available. These stations should be placed close together to minimize time for movement; however far enough apart to avoid interruptions from other groups. For this lesson, choose and set up five learning stations.

Photocopy the handouts located at Annexes I and J and place a copy of each at the appropriate learning station.

Samples of instructional aids available at the corps should be used during this lesson.

PRE-LESSON ASSIGNMENT

N/A.

APPROACH

An interactive lecture was chosen for TP 1 to introduce instructional aids, as it allows the instructor to deliver new information while encouraging the cadets to actively participate by asking and responding to questions.

An in-class activity was chosen for TP 2 as it is an interactive way to introduce the cadets to the different types of instructional aids and to confirm the cadets' comprehension of the material presented.

INTRODUCTION

REVIEW

N/A.

OBJECTIVES

By the end of this lesson the cadet shall have identified and selected appropriate instructional aids for a given topic.

IMPORTANCE

It is important for cadets to know that selecting appropriate instructional aids is an important part of pre-lesson preparation. Using instructional aids during a lesson helps stimulate the cadets' interest and helps them comprehend and recall the new material.

Teaching Point 1

Describe Instructional Aids

Time: 5 min

Method: Interactive Lecture

INSTRUCTIONAL AIDS

Instructional aids consist of various types of learning support that emphasize and clarify teaching points. Instructional aids include handouts, verbal support, audiovisual aids, simulators and real equipment. Instructional aids can be produced locally or purchased externally but must:

- be relevant to the teaching point;
- support learning; and
- be appropriate to the cadets' background and needs.

Instructional aids can be categorized as:

- **Training Aids.** Training aids refer to all types of learning support instructors use to instruct the lesson.
- **Learning Aids.** Learning aids refer to all the materials the cadets use to participate in the lesson and comprehend the material.

CONFIRMATION OF TEACHING POINT 1

QUESTIONS

- Q1. How can instructional aids support learning?
- Q2. How can instructional aids be obtained?
- Q3. What is the difference between a training aid and a learning aid?

ANTICIPATED ANSWERS

- A1. Instructional aids support learning by emphasizing and clarifying teaching points.
- A2. Instructional aids can be produced locally or purchased externally.
- A3. A training aid is used by the instructor to instruct the lesson and a learning aid is used by the cadet to participate in the lesson and comprehend the material.

Teaching Point 2**Conduct an Activity Where the Cadets Will Identify Types of Instructional Aids and Select an Instructional Aid Appropriate for a Given Topic**

Time: 45 min

Method: In-Class Activity

BACKGROUND KNOWLEDGE

The saying “a picture is worth a thousand words”, describes the effectiveness of instructional aids. New instructional aids are being developed all the time and it is important for instructors to know what aids are available, when to use them and how to use them. Some of the more common instructional aids are described in Annex I.



“Show 'em as well as tell 'em!” Cadets will remember more for longer periods of time.

ACTIVITY**OBJECTIVE**

The objective of this activity is to have cadets identify types of instructional aids and select an instructional aid appropriate for a given topic.

RESOURCES

- Instructional aids information sheets,
- Worksheets,
- Stopwatch,
- Signalling device,
- Flip chart paper,
- Coloured markers, and
- Pens/pencils.

ACTIVITY LAYOUT

Set up and label five learning stations “Instructional Aids”, “Verbal Support”, “Audiovisual Aids”, “Simulators and Training Equipment” and “Select an Instructional Aid.”

ACTIVITY INSTRUCTIONS

1. Divide the cadets into five groups and place one group at each learning station.
2. Assign each group a leader. Have the group leader assign a recorder and a reader.
3. Have the cadets read the information sheets and fill out a worksheet on each aspect of instructional aids. It is necessary for each group to fill out only one worksheet.

4. After eight minutes, have the groups rotate clockwise to the next station, where they will have another eight minutes to complete a worksheet.
5. Rotate the groups through the remaining stations.
6. Have the cadets share the information they recorded from each station.

SAFETY

N/A.

CONFIRMATION OF TEACHING POINT 2

The cadets' participation in the activity will serve as the confirmation of this TP.

END OF LESSON CONFIRMATION

The cadets' participation in the instructional aids activity in TP 2 will serve as the confirmation of this lesson.

CONCLUSION

HOMEWORK/READING/PRACTICE

N/A.

METHOD OF EVALUATION

This EO is assessed IAW A-CR-CCP-703/PG-001, Chapter 3, Annex B, Appendix 3 (309 PC).

CLOSING STATEMENT

Instructional aids appeal to all five senses but mainly to our senses of sight and hearing. It has often been reported that 75 percent of all learning happens through sight and that you remember 50 percent more when you both see and hear the information. It naturally follows therefore, that learning is enhanced when instructional aids are used.

INSTRUCTOR NOTES/REMARKS

Samples of instructional aids available at the corps should be used during this lesson.

REFERENCES

- A0-056 A-P9-050-000/PT-005 Director Training and Education Policy. (2001). *Canadian Forces Individual Training and Education System*. (Vol. 5). Ottawa, ON: Department of National Defence.
- A0-057 A-CR-CCP-913/PT-001 Cadet Instructors List Training School. (1978). *Technique of Instruction*. Ottawa, ON: Department of National Defence.
- A0-058 A-P9-050-000/PT-004 Director Training and Education Policy. (1999). *Canadian Forces Individual Training and Education System*. (Vol. 4). Ottawa, ON: Department of National Defence.
- C0-194 Dynamic Flight, Inc. *Instructional Aids and Training Technologies*. (2003). Retrieved March 20, 2008, from http://www.dynamicflight.com/avcfibook/inst_aids.



COMMON TRAINING
SILVER STAR
INSTRUCTIONAL GUIDE



SECTION 6

EO M309.06 – PLAN A LESSON

Total Time:

60 min

PREPARATION

PRE-LESSON INSTRUCTIONS

Resources needed for the delivery of this lesson are listed in the lesson specification located in A-CR-CCP-703/PG-001, Chapter 4. Specific uses for said resources are identified throughout the instructional guide within the TP for which they are required.

Review the lesson content and become familiar with the material prior to delivering the lesson.

Photocopy the lesson specification and instructional guide handout located at Annex K, the blank lesson plan located at Annex L and the plan a lesson checklist located at Annex M for each cadet.

Photocopy the lesson specifications and instructional guides located at Annexes N to AB as required.

PRE-LESSON ASSIGNMENT

N/A.

APPROACH

An interactive lecture was chosen for TPs 1–3 to present basic material on how to research lesson content and how to prepare for a lesson.

A practical activity was chosen for TP 4 to allow the cadets to plan a lesson in a structured and controlled environment. This activity contributes to the development of lesson-planning skills and will serve as preparation for EO M309.07 (Instruct a 15-Minute Lesson, Section 7).

INTRODUCTION

REVIEW

N/A.

OBJECTIVES

By the end of this lesson the cadet shall be expected to research lesson content and develop a lesson plan.

IMPORTANCE

It is important for cadets to research lesson content, prepare a lesson location and plan a lesson because these are critical steps to the success of a period of instruction. The preparation of a lesson location sets the tone for

the lesson and a well-developed lesson plan provides structure and organization, guides the instructor through each stage of the lesson and ensures that all essential information is delivered.

Teaching Point 1

Explain How to Research Lesson Content

Time: 10 min

Method: Interactive Lecture



Some common abbreviations and terms used by training officers and instructors:

- **QSP.** Qualification Standard and Plan.
- **PO.** Performance Objective.
- **EO.** Enabling Objective.
- **TP.** Teaching Point.
- **PC.** Performance Check.
- **EC.** Enabling Check.
- **IG.** Instructional Guide.

RESEARCHING LESSON CONTENT

To plan for a lesson, the cadets will need to research lesson content and become familiar with the conditions, standard, TPs, lesson content and the time allocated for the EO and TPs.

The Canadian Forces employs an acronym that is used to provide a framework for the instructor to gather and organize the reference material into an efficient and practical lesson plan. The initialism is CCSAM.

Collect. During this step, the instructor researches the material to be covered in the period of instruction using course documents such as the lesson specification, IG and listed references. In situations where no course documents exist, the instructor will research the material to be taught using whatever references exist.

Consider. During this step, the instructor sifts through all of the material found in the collection step and determines what is relevant and current.

Select. During this step, instructor selects the material that is appropriate for the lesson. The instructor also selects the method of instruction to be used.

Arrange. During this step, the instructor arranges the material into stages that allow for the information to be presented in a logical sequence.

Master. During this step, the instructor writes the lesson plan.



The use of CCSAM is a good general practice. In most cases for cadet training these steps have been completed during the development of the lesson specifications and IGs. The instructor may need to only transpose the information into the pertinent parts of their lesson plan.



Distribute the lesson specification and instructional guide handout located at Annex K to each cadet.

ENABLING OBJECTIVE AND LESSON SPECIFICATION



Enabling objectives and lesson specifications can be found in Chapter 4 of the QSP.

Performance objectives are broken down into a series of enabling objectives and lesson specifications. The enabling objective consists of Paragraphs 1. to 3. (as illustrated in Figure 9-6-1). The information in these paragraphs will answer three questions:

1. What will the cadet be expected to be able to do by the end of this lesson?
2. Under what conditions will the cadet be expected to carry out the performance?
3. How well or to what standard will the cadet be expected to perform?

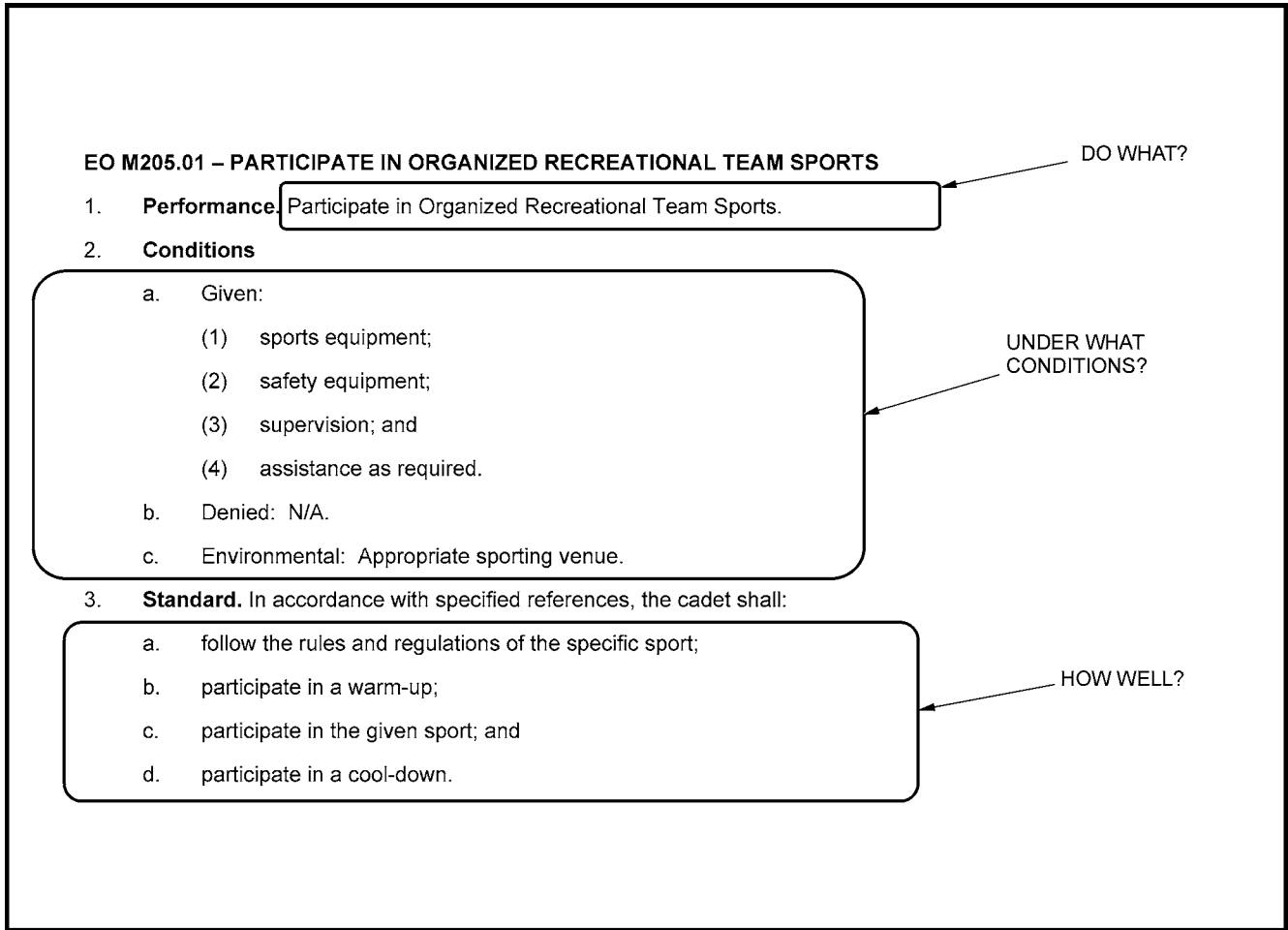

Director Cadets 3, 2008, Ottawa, ON: Department of National Defence

Figure 9-6-1 Enabling Objective

Paragraphs 4. to 11. are known as the lesson specification. The lesson specification provides information about the content to be taught, teaching methods, time, references, training aids, learning aids, test details and remarks.

In Paragraph 4., the TPs are usually described in a table where information is provided on the content taught in each TP, the suggested teaching method, the time for each TP and references (as illustrated in Figure 9-6-2).

4. Teaching Points

TP	Description	Method	Time	Ref
TP1	Introduce cadets to a specific sport's rules and regulations, to include: <ul style="list-style-type: none"> a. an overview of how to play the sport; and b. rules and regulations of the sport. 	Interactive Lecture	10 min	C0-001
TP2	Conduct a warm-up session, composed of light cardiovascular exercises, meant to: <ul style="list-style-type: none"> a. stretch the muscles; b. gradually increase respiratory action and heart rate; c. expand the muscles' capillaries to accommodate the increase in blood circulation; and d. raise muscle temperature to facilitate reactions in muscle tissue. 	Practical Activity	10 min	C0-002 (pp. 109 to 113) C0-089
TP3	Supervise the cadets' participation in a given sports activity.	Practical Activity	50 min	

Annotations in the diagram:

- CONTENT TO BE TAUGHT: points to the Description column.
- LENGTH OF TP: points to the Time column.
- REFERENCE NUMBER: points to the Ref column.
- SUGGESTED TEACHING METHOD: points to the Method column.

Director Cadets 3, 2008, Ottawa, ON: Department of National Defence

Figure 9-6-2 Teaching Points

Paragraph 5. outlines how much time is spent on the introduction/conclusion and the different teaching methods. Paragraph 6. offers substantiation or reasons why certain teaching methods were recommended for each TP. Paragraph 7. provides a list of references used to compile the content in Paragraph 4. (as illustrated in Figure 9-6-3).

- | | | |
|----|--------------------------|---------|
| 5. | Time | |
| a. | Introduction/Conclusion: | 10 min |
| b. | Interactive Lecture: | 10 min |
| c. | Practical Activity: | 70 min |
| d. | Subtotal: | 90 min |
| e. | Total (three sessions): | 270 min |
6. **Substantiation**
- An interactive lecture was chosen for TP1 to illustrate the application of rules, principles, or concepts of the specific sport to be played.
 - A practical activity was chosen for TP2 to TP4 as it allows cadets to participate in sports activities in a safe and controlled environment. This activity contributes to the development of sports skills in a fun and challenging setting.
7. **References**
- C0-001 (ISBN 0-88011-807-5) Hanlon, T. (1998). *The Sports Rules Book: Essential Rules for 54 Sports*. USA: Human Kinetics Publishers, Inc.
 - C0-002 (ISBN 0-88962-630-8) LeBlanc, J., and Dickson, L. (1997). *Straight Talk About Children and Sport: Advice for Parents, Coaches, And teachers*. Oakville, ON and Buffalo, NY: Mosaic Press.

Director Cadets 3, 2008, Ottawa, ON: Department of National Defence

Figure 9-6-3 Paragraphs 5–7

Paragraphs 8. and 9. list the training aids and learning aids required for the lesson. Training aids are the materials that are required by the instructor to instruct the lesson and learning aids are the materials that will be required by the cadet to participate in the lesson (as illustrated in Figure 9-6-4).

8. **Training Aids**
- Sports/safety equipment appropriate for the activity;
 - First aid kit;
 - Whistles; and
 - Stopwatch.
9. **Learning Aids.** Sports equipment.

Director Cadets 3, 2008, Ottawa, ON: Department of National Defence

Figure 9-6-4 Training Aids and Learning Aids

Paragraph 10. is test details, which is information about the evaluation to be conducted. Paragraph 11. is remarks, which describe any other information that may be useful to the Training Officer or instructor (as illustrated in Figure 9-6-5).

10. Test Details. N/A.
11. Remarks
a. The CCO list of approved sports is located at A-CR-CCP-702/PF-001, Chapter 5, Annex A.
b. Recreational sports can be carried out as nine periods during a supported day or over three sessions of three periods each.

Director Cadets 3, 2008, Ottawa, ON: Department of National Defence

Figure 9-6-5 Test Details and Remarks

	<p>Test details will be described in one of the following ways:</p> <ul style="list-style-type: none"> • N/A. No evaluation for this EO. • This EO is Assessed IAW Chapter 3, Annex B, 209 PC. There is a performance check (PC) associated with this EO, refer to Chapter 3, Annex B for details. • This EO is Assessed IAW Chapter 3, Annex B, 209 EC 01. There is an enabling check (EC) associated with this EO, refer to Chapter 3, Annex B for details.
---	---

INSTRUCTIONAL GUIDE

The IG is used in conjunction with the QSP and other resources to conduct training. IGs should be reviewed in conjunction with lesson specifications so that the instructor can adequately plan and prepare their lesson. IGs do not replace lesson plans but offer written content, supporting figures and suggestions on how to instruct a lesson. The following are the six sections of an IG:

1. preparation,
2. introduction,
3. body,
4. conclusion,
5. references, and
6. annexes.

Preparation

The preparation section provides information about where to find the lesson specification and any instructions to the instructor such as reviewing lesson content, photocopying handouts, pre-lesson assignments and the approach and substantiation as to why certain teaching methods were recommended for each TP.





Introduction

The introduction section provides information to the instructor about review that may be necessary, what the cadet will be expected to do by the end of the lesson and why the knowledge/skills are important.

The Body

The body of the IG contains all of the TPs and content listed in Paragraph 4. of the lesson specification in greater detail. The body provides suggested teaching methods, note boxes with special instructions or information (as illustrated in Figure 9-6-6), lesson content, figures, activities and confirmation questions.

Note Boxes:

	Special note to the instructor.
	Key information to pass along to the cadets.
	Refer to the following CF regulations and policies.
	Points of interest or special instructions the instructor should pass along to the cadets.

Director Cadets 3, 2008, Ottawa, ON: Department of National Defence

Figure 9-6-6 Note Boxes

The Conclusion

The conclusion section states any homework/reading/practice that may be required of the cadet and the method of evaluation as stated in the lesson specification. The conclusion section also provides a closing statement to be spoken aloud to the cadets and any additional instructor notes/remarks.

References

The reference section lists the references used to create the lesson specification and instructional guide. In some cases, an IG may direct the instructor to a specific reference to be used during a lesson. In most cases this section is only used to identify where the content of the lesson has been drawn from.

Annexes

The annex section contains information that may range from pre-made training aids, learning aids such as handouts and additional information for activities.

CONFIRMATION OF TEACHING POINT 1

QUESTIONS

- Q1. Where can a lesson specification be found?
- Q2. What information can be found in the preparation section of an instructional guide?
- Q3. What information can be found in the body of an instructional guide?

ANTICIPATED ANSWERS

- A1. In Chapter 4 of the QSP.
- A2. The preparation section provides information about where to find the lesson specification and any instructions to the instructor such as reviewing lesson content, photocopying handouts, pre-lesson assignments and the approach and substantiation as to why certain teaching methods were recommended for each TP.
- A3. The body of the IG contains all of the TPs and content listed in Paragraph 4. of the lesson specification in greater detail. The body provides suggested teaching methods, note boxes with special instructions or information (as illustrated in Figure 9-6-6), lesson content, figures, activities and confirmation questions.

Teaching Point 2

Explain How to Prepare for a Lesson

Time: 5 min

Method: Interactive Lecture

PREPARING FOR A LESSON

A well-prepared and positive learning environment can enhance a lesson and the learning experience.

The cadets' attention will not only be focused on the instructor but also on the environment around them. Effort put into lesson preparation and presentation can be wasted if the environment is not prepared for optimal learning.

Selecting a Lesson Location

When selecting a lesson location the instructor should consider the following:

- the type of training to be conducted (eg, general cadet knowledge versus navigation);
- any activities outlined in the instructional guide;
- the size of the group being trained;
- the size of the location;
- the lighting of the location;
- the ventilation of the location;
- the suitability of the location regarding noise distractions; and
- the suitability of the location regarding the use of visual aids.

Setting Up the Location

After selecting a lesson location, the instructor must take steps to ensure the location is clean and arranged properly for an optimal training environment.

Cleanliness. A clean training area will prevent distractions and will positively affect motivation. Cadets will notice a messy, disorganized area immediately and will be distracted before the class begins. The room must be clean and well-organized with the boards wiped clean, debris picked up, garbage cans empty, etc.

Seating Arrangements. Cadets must be able to see the instructor, the visual aids and each other to achieve maximum participation. Some arrangements will not be possible given the allotted space. The following descriptions and diagrams depict possible seating arrangements:

- **U-Shaped.** Allows the instructor to see all cadets easily and also allows trainees to see each other.

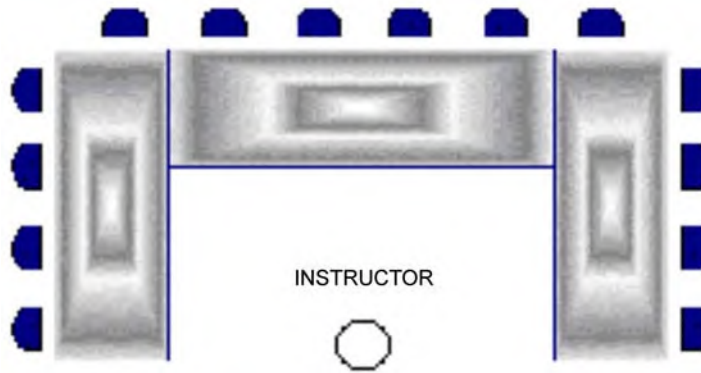

E. Jenson, Super Teaching: Mastering Strategies for Building Trainee Success, The Brain Store Inc. (p. 109)

Figure 9-6-7 U-Shaped

- **Chevron Shape.** Found mostly in auditorium-style rooms and can accommodate large groups.

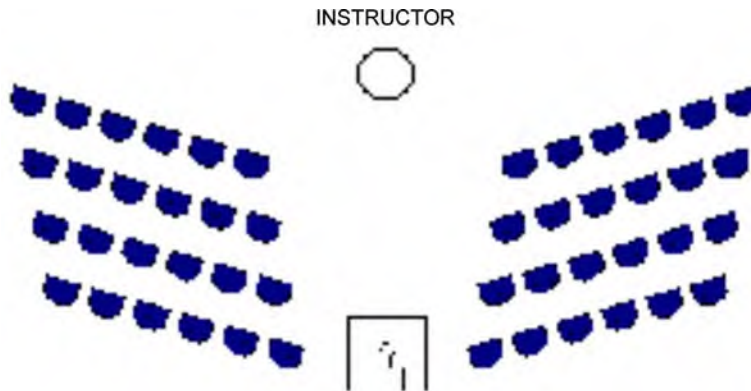

E. Jenson, Super Teaching: Mastering Strategies for Building Trainee Success, The Brain Store Inc. (p. 109)

Figure 9-6-8 Chevron Shape

- **Horseshoe.** Can be employed for two groups. This set-up works well during debates and in-class activities.

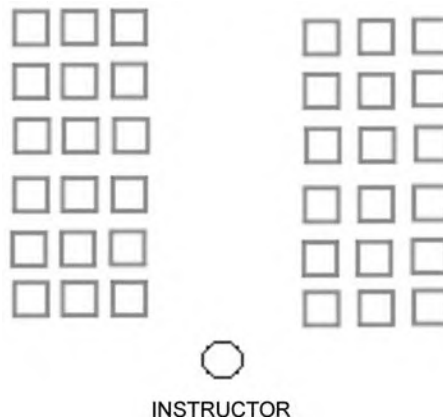

E. Jenson, Super Teaching: Mastering Strategies for Building Trainee Success, The Brain Store Inc. (p. 109)

Figure 9-6-9 Horseshoe

- **Semicircle.** Instructor has a good view of the cadets.

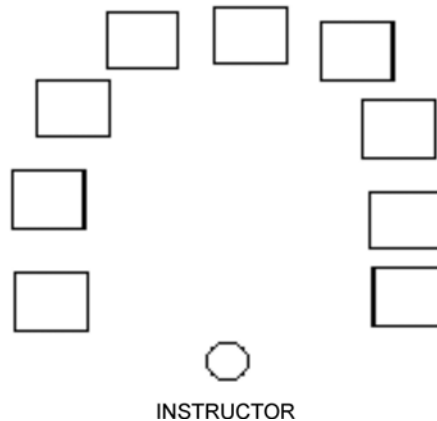

E. Jenson, Super Teaching: Mastering Strategies for Building Trainee Success, The Brain Store Inc. (p. 109)

Figure 9-6-10 Semicircle

- **Standard in Line.** Allows for more frontal coverage with less depth front to back.

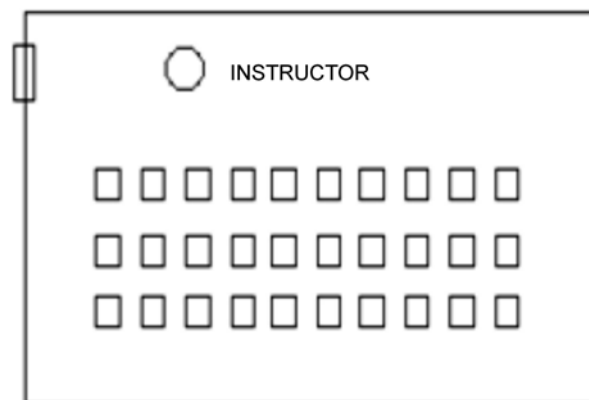

E. Jenson, Super Teaching: Mastering Strategies for Building Trainee Success, The Brain Store Inc. (p. 109)

Figure 9-6-11 Standard in Line

CONFIRMATION OF TEACHING POINT 2

QUESTIONS

- Q1. What should the instructor consider when selecting a lesson location?
- Q2. Why is it important to have a clean lesson location?
- Q3. What are three seating arrangements?

ANTICIPATED ANSWERS

- A1. When selecting a lesson location the instructor should consider the following:
- the type of training to be conducted (eg, general cadet knowledge versus navigation);
 - any activities outlined in the instructional guide;

- the size of the group being trained;
- the size of the location;
- the lighting of the location;
- the ventilation of the location;
- the suitability of the location regarding noise distractions; and
- the suitability of the location regarding the use of visual aids.

A2. Cadets will notice a messy, disorganized area immediately and will be distracted before the class begins.

A3. Seating arrangements are:

- u-shaped,
- chevron shape,
- horseshoe,
- semicircle, and
- standard in line.

Teaching Point 3

Describe the Lesson Plan Format

Time: 10 min

Method: Interactive Lecture

LESSON PLAN FORMAT

The lesson plan is a way for the instructor to organize the lesson and summarize the information included in the lesson specification, the IG and their personal ideas. Lesson plans provide a set of detailed directions for delivering one or more periods of instruction.

The lesson plan is arranged in this specific order:

Part	Purpose
1. Introduction	Builds the cadets' interest and motivation.
2. Body	Presents and explains each TP.
3. End of Lesson Confirmation	Confirms cadets' comprehension of the lesson.
4. Conclusion	Summarizes key points and identifies future lessons.

Introduction

The introduction is the instructor's first verbal interaction with the cadets. It should capture the cadets' interest. The following should be included in the introduction of a lesson plan:

- **What.** A description of what the cadets will be expected to accomplish at the end of the lesson.
- **Where.** A description of how and where the lesson fits into the Cadet Program.
- **Why.** A description of why it is important for the cadets to achieve the objectives.



Read the Objective and Importance paragraphs in the IG for help in writing the introduction of the lesson plan.

Body

The body of the lesson plan is where the content is presented, explained and supported. Each TP directs the instructor and the cadets.

Each TP in the lesson includes:

- **Introduction.** Briefly introduce the content to be taught during the TP.
- **Teaching Method.** Identify which teaching method has been chosen for the TP.
- **Lesson Content.** Present the content of the TP in a clear and logical order, from easy to difficult, known to unknown and simple to complex.
- **Confirmation.** May be oral questions, games, role play, in-class activities or practical activities. IGs offer suggestions for how to confirm TPs. Instructors may choose to use those confirmation suggestions or develop their own.

End of Lesson Confirmation

The lesson plan should outline procedures to be used to confirm the learning of the TP. End of lesson confirmations are carried out to ensure that the cadets understood the whole lesson and that any weaknesses in performance are identified so they can be corrected.

Confirmation activities are based on the lesson objectives. The end of lesson confirmation may be oral questions, games, role play, in-class activities or practical activities. IGs offer suggestions for how to conduct end of lesson confirmations. Instructors may choose to use those confirmation suggestions or develop their own.

Conclusion

The conclusion of a lesson summarizes the key points and links them to the coming lessons and their practical use.

A Summary of Important Points and Weak Areas. The summary reviews the main TPs. The depth of the summary will be determined by the lesson objectives and the results of the cadets' end of lesson confirmation. If the cadets achieved the objectives successfully, the summary may be brief. If they experienced some difficulties, the instructor should identify them here and indicate how the issue will be addressed.

Re-Motivation Statement. The re-motivation statement restates the importance of the lesson (the "why") and re-motivates the cadets. The instructor should also take this time to address any precautions the cadets should be aware of when applying the knowledge in a practical setting and give an overview of the next lesson.



Read the Closing Statement paragraph in the IG for help in writing the conclusion of the lesson plan.

CONFIRMATION OF TEACHING POINT 3

QUESTIONS

Q1. What are the four sections of a lesson plan?

Q2. What three questions are answered in the introduction?

Q3. What are the four sections of a teaching point?

ANTICIPATED ANSWERS

A1. The four sections of a lesson plan are:

- introduction,
- body,
- end of lesson confirmation, and
- conclusion.

A2. The three questions answered in the introduction are:

- what,
- where, and
- why.

A3. The four sections of a teaching point are:

- introduction,
- teaching method,
- lesson content, and
- confirmation.

Teaching Point 4

Supervise and Provide Assistance While the Cadets Plan a Lesson

Time: 25 min

Method: Practical Activity

In EO M309.07 (Instruct a 15-Minute Lesson, Section 7) the cadets will be expected to instruct a lesson using a lesson plan, an instructional aid and the appropriate instructional method. The lesson plan created in this EO will be used to instruct that lesson.



Distribute the blank lesson plan located at Annex L and the plan a lesson checklist located at Annex M to each cadet.



As the cadets begin to place information in the lesson plan, they will need to know what information to place in the two columns not discussed in the previous TP.

Time. This column reminds the instructor how long to spend on each section of the lesson.

Notes. The instructor can place information in this column as a reminder of when to distribute a handout, to pass along special information to the class or information about a confirmation activity.

INSTRUCTIONS AND REMINDERS		
LESSON PLAN		
EO #:	Title of the EO:	
Instructor:	Location:	Total Time: min
TIME	INTRODUCTION	NOTES
3 min	What: Where: Why:	Distribute handouts here.
TIME	BODY	NOTES
10 min	TP: Teaching Method: TP 1:	Use analogy here.
EXPECTED TIME		

Director Cadets 3, 2008, Ottawa, ON: Department of National Defence

Figure 9-6-12 Lesson Plan

ACTIVITY

OBJECTIVE

The objective of this activity is to have the cadets plan a 15-minute lesson.

RESOURCES

- List of approved 15-minute topics located at Annex M, and
- Modified lesson specifications and instructional guides located at Annexes N to AB.

ACTIVITY LAYOUT

N/A.

ACTIVITY INSTRUCTIONS

1. Have each cadet choose a topic from the list of approved 15-minute topics.

2. Have the cadets use the lesson specification and IG for their chosen topic to help develop their lesson plan. Cadets shall be expected to teach their chosen lesson as part of M309.07 (Instruct a 15-Minute Lesson, Section 7).
3. Circulate around the room facilitating the activity and helping the cadets as required.

	Ensure that cadets request all resources required to instruct their lesson.
---	---

SAFETY

N/A.

CONFIRMATION OF TEACHING POINT 4

The cadets' participation in the activity will serve as the confirmation of this TP.

END OF LESSON CONFIRMATION

The cadets' completion of a lesson plan will serve as the confirmation of this lesson.

CONCLUSION

HOMEWORK/READING/PRACTICE

The cadets should be prepared to instruct their lesson at the beginning of M309.07 (Instruct a 15-Minute Lesson, Section 7).

METHOD OF EVALUATION

This EO is assessed IAW A-CR-CCP-703/PG-001, Chapter 3, Annex B, Appendix 3 (309 PC).

CLOSING STATEMENT

Researching lesson content, preparing a lesson location and planning a lesson are critical steps in preparing a period of instruction. The preparation of a lesson location sets the tone for the lesson to be taught and a well-developed lesson plan provides structure and organization, guides the instructor through each stage of the lesson and ensures that all essential information is delivered.

INSTRUCTOR NOTES/REMARKS

EO M309.06 (Plan a Lesson) should be scheduled at least one week prior to EO M309.07 (Instruct a 15-Minute Lesson, Section 7).

EO C309.02 (Plan a Lesson, Section 9) may be scheduled as additional time for this EO.

REFERENCES

A1-042 A-P9-050-000/PT-005 Director Training and Education Policy. (2001). *Canadian Forces Individual Training & Education System* (Vol. 5). Ottawa, ON: Department of National Defence.

- C1-133 (ISBN 0-9695066-2-7) Bender, P. (2000). *Secrets of Power Presentations*. Toronto, ON: The Achievement Group.
- C1-140 (ISBN 1-890460-02-8) Jenson, E. (1999). *Super Teaching: Mastering Strategies for Building Trainee Success*. San Diego, CA: The Brain Store Inc.

THIS PAGE INTENTIONALLY LEFT BLANK



COMMON TRAINING
SILVER STAR
INSTRUCTIONAL GUIDE



SECTION 7

EO M309.07 – INSTRUCT A 15-MINUTE LESSON

Total Time:

90 min

PREPARATION

PRE-LESSON INSTRUCTIONS

Resources needed for the delivery of this lesson are listed in the lesson specification located in A-CR-CCP-703/PG-001, Chapter 4. Specific uses for said resources are identified throughout the instructional guide within the TP for which they are required.

Review the lesson content and become familiar with the material prior to delivering the lesson.

Photocopy the Instructional Techniques Assessment Form located at Annex AC for each cadet.

Ensure that all resources requested by the cadets are available.

PRE-LESSON ASSIGNMENT

N/A.

APPROACH

A practical activity was chosen for this lesson as it is an interactive way for cadets to develop instructional skills in a safe and controlled environment.

INTRODUCTION

REVIEW

N/A.

OBJECTIVES

By the end of this lesson the cadet shall have instructed a 15-minute lesson using a lesson plan, an appropriate method of instruction and an appropriate instructional aid.

IMPORTANCE

It is important for cadets to instruct a 15-minute lesson as it gives them the opportunity to practice instructional techniques in a peer setting and to receive feedback to further develop their confidence.

Teaching Point 1**Have the Cadets Instruct a 15-Minute Lesson**

Time: 85 min

Method: Practical Activity

ACTIVITY**OBJECTIVE**

The objective of this activity is to have the cadets instruct a 15-minute lesson in a peer setting using a lesson plan, an appropriate method of instruction and an appropriate instructional aid.

RESOURCES

- Presentation aids (eg, whiteboard/flip chart/OHP) appropriate for the classroom/training area, and
- Instructional Techniques Assessment Form.

ACTIVITY LAYOUT

N/A.

ACTIVITY INSTRUCTIONS

1. Have the cadets provide a copy of their lesson plan to the assessor.
2. Determine the order in which cadets will instruct their lessons.
3. Have one cadet prepare the classroom/training area for their lesson.
4. Have one cadet instruct a 15-minute lesson using a written lesson plan, an appropriate method of instruction and an appropriate instructional aid (as prepared in EO M309.06 [Plan a Lesson, Section 6]).
5. Assess the cadet's lesson using the Instructional Techniques Assessment Form.
6. Upon completion of the lesson, provide feedback to the cadet.
7. Repeat Steps 3. to 6. until all cadets have instructed a lesson.



The Instructional Techniques Assessment Form located at Annex AC is used to provide feedback on the cadet's lesson and to introduce the cadet to the type of instructional techniques assessment they will receive in their future star level training. The grey areas of the form are those applicable to the 309 PC (eg, the standard required for the achievement of PO 309). The remainder of the form is intended solely for the purposes of assessment for learning, providing the cadets with the feedback they need to improve their skills.

8. Debrief the cadets by providing feedback, focusing on:
 - a. best practices,
 - b. general trends and key areas for improvement, and
 - c. re-motivation, highlighting the effort and accomplishments of the group.



If the group of cadets is large, divide them up into smaller groups and assign other instructors to aid with assessment and feedback.

SAFETY

N/A.

CONFIRMATION OF TEACHING POINT 1

The cadets' participating in the activity will serve as the confirmation of this TP.

END OF LESSON CONFIRMATION

The cadets' instructing a 15-minute lesson will serve as the confirmation of this lesson.

CONCLUSION

HOMEWORK/READING/PRACTICE

N/A.

METHOD OF EVALUATION

This EO is assessed IAW A-CR-CCP-703/PG-001, Chapter 3, Appendix 3 (309 PC).

CLOSING STATEMENT

Practicing instructional skills in a peer setting allows for the development of skills necessary to become a competent instructor while further developing confidence and a sense of accomplishment.

INSTRUCTOR NOTES/REMARKS

Additional time for this EO is available in EO C309.03 (Instruct a 15-Minute Lesson, Section 10).

REFERENCES

A0-055 A-P9-050-000/PT-006 Director Training and Education Policy. (2002). *Canadian Forces Manual of Individual Training and Education* (Vol. 6). Ottawa, ON: Department of National Defence.

THIS PAGE INTENTIONALLY LEFT BLANK



COMMON TRAINING
SILVER STAR
INSTRUCTIONAL GUIDE



SECTION 8

EO C309.01 – DELIVER A ONE-MINUTE VERBAL PRESENTATION

Total Time: 60 min

PREPARATION

PRE-LESSON INSTRUCTIONS

Resources needed for the delivery of this lesson are listed in the lesson specification located in A-CR-CCP-703/PG-001, Chapter 4. Specific uses for said resources are identified throughout the instructional guide within the TP for which they are required.

Review the lesson content and become familiar with the material prior to delivering the lesson.

Photocopy the list of topics located at Annex AD and the verbal presentation feedback form located at Annex AE for each cadet.

PRE-LESSON ASSIGNMENT

N/A.

APPROACH

A group discussion was chosen for TP 1 as it allows the cadets to interact with their peers and share their knowledge, experiences, opinions and feelings about public speaking.

An interactive lecture was chosen for TP 2 as it allows the instructor to explain the expectations of the cadets for the one-minute verbal presentation.

A practical activity was chosen for TP 3 as it is an interactive way to help the cadets develop effective-speaking skills in a safe and controlled environment.

INTRODUCTION

REVIEW

Review EO M309.03 (Describe Effective-Speaking Techniques, Section 3).

OBJECTIVES

By the end of this lesson the cadet shall have delivered a one-minute verbal presentation.

IMPORTANCE

It is important for cadets to practice effective-speaking techniques because this will develop the skills required to present information and build the self-confidence needed to speak in front of others.

Teaching Point 1**Review Effective-Speaking Techniques**

Time: 15 min

Method: Group Discussion

BACKGROUND KNOWLEDGE

The purpose of the group discussion is to draw the following information from the group using the tips for answering/facilitating discussion and the suggested questions provided.

ELEMENTS OF VOICE CONTROL

One of the most important and effective tools of communication is voice control. The ability to use voice control to communicate effectively and place emphasis on important information is a fundamental skill that will be used while in front of an audience.

Pitch. How high or low a voice is. A change in pitch usually does not add any significance to a message. However, a pitch change will be noticed by the audience and will keep people involved.

Tone. The quality of the sound of a voice. Effective communicators will often change the tone of their voice to give emphasis to a single word or phrase to convey emotion and conviction.



Monotone. A sound without change of pitch or tone.

Volume. The quantity or power of sound or fullness of tone. A change in volume often signifies emphasis on a particular phrase or point. Environmental factors such as outside noise and room size must be taken into consideration to ensure the audience can hear the message being sent.

Speed. The rate or rapidity in which words are spoken. Speaking too fast or too slow can be distracting to an audience. It is important to communicate at a pace that ensures the audience can understand every word being said.

Pause. A break in speaking or reading. A pause is an important part of the communication process. A pause gives the audience an opportunity to digest what has been said and to ask questions. A pause is also an effective way to announce a change in subject or an important point.

Articulation. The clear and distinct pronunciation of a word. It is important to properly pronounce and articulate words to ensure the audience can understand the message being sent.

ELEMENTS OF PHYSICAL PRESENCE

It is estimated that 93 percent of the total meaning of a message comes from non-verbal communication and only 7 percent of meaning comes from the words themselves. Being aware of physical presence and its effect on a message being sent is an important element of effective communication.

Body Language

Body language or non-verbal communication is the process of communicating through conscious and unconscious gestures and expressions. Understanding that body language affects how a message is received and interpreted is an important tool for communicating effectively.

Facial Expressions. While 93 percent of the total meaning of a message comes from non-verbal communication, most of that meaning is communicated by the eyes, eyebrows and mouth. The movement of the eyes, eyebrows and mouth can result in an infinite variety of expressions to complement the spoken word. It is important that facial expressions match the tone of the message being sent to create emphasis and believability. A smile is the most important of all facial expressions. A smile adds sincerity to a message and will add to the likeability of the individual in front of the audience.

Eye Contact. Maintaining eye contact is an effective way of engaging an audience and building interest. Pausing two or three seconds on each member of the audience will make them feel as though they are involved in a one-on-one conversation. It is important to look at the entire room and scan from left to right, back to front.

Gestures. The combination of hand, arm and shoulder movements can make a wide variety of gestures that can help add meaning to a message. Effective communicators will let their hands and arms move naturally to help give emphasis and emotion to a message. It is important not to point directly at members of the audience or let gestures become distracting.

Movement. Being aware of movement while in front of an audience is very important to communication. Movement will keep listeners engaged and interested in what is being said. Moving around the front of the room, toward and away from an audience and from side to side can help emphasize points. Too much or frantic movement can become distracting and will affect how a message is received.



Hands placed in pockets are typically a sign of nervousness or overconfidence.

Dress and Deportment

Effective communicators are constantly aware of their dress and deportment. Audiences will react differently to an individual who is well dressed and acts professionally when in front of them, than an individual who is poorly dressed and acts unprofessionally.

Dress. Effective communicators will always appear in clean, well-pressed and appropriate attire. Dressing appropriately for the event will help create confidence and credibility.

Deportment. An audience that sees an individual as being prepared, on time, appropriately dressed and confident will be much more receptive, than to an individual who is unprepared, late, poorly dressed and nervous. The most important element of deportment is displaying an interest in the subject; this will be noticed by the audience and will generate interest in the presentation.

PREPARATION

Effective speaking preparation is the most critical component of effective communication. Preparation will help ensure confidence, control nervousness and increase the likelihood of success when in front of an audience.

The following are the steps to effective-speaking preparation:

1. **Practicing.** Proper rehearsal will aid in memorizing content, which will allow for more eye contact and movement while in front of an audience. Memorizing the introduction and conclusion are the two most critical elements; a strong introduction will aid in gaining confidence and will draw the interest of the audience, a strong conclusion will aid in leaving a lasting impression on the audience. If possible, practice in front of a small group, speak aloud even when practicing alone and always practice while standing.
2. **Controlling Nervousness.** The feeling of nervousness prior to speaking in front of a group is normal and often can help if channeled effectively. The following actions can be taken to control nervousness:

- a. **Room Layout.** Become familiar with the layout of the room prior to speaking.
 - b. **Materials.** Ensure notes, handouts and presentation aids are organized.
 - c. **Equipment.** Ensure any equipment being used is in working order and ready to use.
 - d. **Practice.** Spend time going over notes and rehearsing content.
 - e. **Attitude.** Enter the room with a smile and a positive and confident attitude.
 - f. **Breathing.** Take a deep breath before entering the room. Slow down the delivery if necessary and breathe from the diaphragm while speaking, not from the chest.
3. **Identifying a Friendly Face.** While walking in front of an audience, identify a friendly face. Making eye contact with a friendly face while beginning to speak will often give confidence while beginning the introduction and ultimately lead to success when addressing an audience.

GROUP DISCUSSION



TIPS FOR ANSWERING/FACILITATING DISCUSSION

- Establish ground rules for discussion, eg, everyone should listen respectfully; don't interrupt; only one person speaks at a time; no one's ideas should be made fun of; you can disagree with ideas but not with the person; try to understand others as much as you hope they understand you; etc.
- Sit the group in a circle, making sure all cadets can be seen by everyone else.
- Ask questions that will provoke thought; in other words avoid questions with yes or no answers.
- Manage time by ensuring the cadets stay on topic.
- Listen and respond in a way that indicates you have heard and understood the cadet. This can be done by paraphrasing their ideas.
- Give the cadets time to respond to your questions.
- Ensure every cadet has an opportunity to participate. One option is to go around the group and have each cadet answer the question with a short answer. Cadets must also have the option to pass if they wish.
- Additional questions should be prepared ahead of time.

SUGGESTED QUESTIONS

- Q1. How can voice be varied to maintain class interest?
- Q2. How does physical presence affect how a message is received?
- Q3. What is one of the most important elements of deportment?
- Q4. What are some ways for controlling nervousness?



Other questions and answers will develop throughout the group discussion. The group discussion should not be limited to only those suggested.



Reinforce those answers given and comments made during the group discussion, ensuring the teaching point has been covered.

Teaching Point 2

Explain the Expectations of the One-Minute Verbal Presentation

Time: 10 min

Method: Interactive Lecture

EXPECTATIONS OF THE ONE-MINUTE VERBAL PRESENTATION

The expectations of the one-minute verbal presentation are to practice the following skills:

1. using effective speaking techniques to communicate ideas; and
2. speaking clearly and confidently in front of a group of peers.

Instructions

1. Each cadet is required to deliver a one-minute verbal presentation on a topic chosen from the list located at Annex AD.
2. Each cadet is permitted to use one piece of paper not larger than 8 1/2 inches by 11 inches for outline notes. Cadets are not permitted to read their presentations directly from the paper.
3. Cadets will not be given assistance during their presentations other than the signal from the timekeeper.
4. Cadets will be given feedback using the feedback form located at Annex AE. The feedback positively emphasizes what the cadet did well and areas for improvement.
5. Aids such as a podium, OHP or flip charts should be made available (where possible), if requested by the cadet, prior to the presentation.
6. A timekeeper will be present to signal the cadet when they are nearing the one-minute mark.



Hand out the list of topics located at Annex AD and have the cadets choose what topic they will speak about.

Hand out the Verbal Presentation Feedback Form located at Annex AE to each cadet and discuss how it will be used.

CONFIRMATION OF TEACHING POINT 2

QUESTIONS

- Q1. What is the aim of the one-minute verbal presentation?
- Q2. When should aids required for the presentation be requested?

ANTICIPATED ANSWERS

- A1. To practice the skills for effectively communicating ideas by speaking clearly and confidently.

A2. Prior to the presentation.

Teaching Point 3

Conduct an Activity Where the Cadets Will Deliver a One-Minute Verbal Presentation

Time: 25 min

Method: Practical Activity



This activity should be conducted on a separate training night from TP 1 & 2 to allow the cadets an opportunity to prepare their verbal presentations.

ACTIVITY

OBJECTIVE

The objective of this activity is to have the cadets deliver a one-minute verbal presentation.

RESOURCES

- Presentation aids (eg, whiteboard/flip chart/OHP) appropriate for the classroom/training area,
- Other presentation aids as requested by the cadets, and
- Verbal Presentation Feedback Form.

ACTIVITY LAYOUT

N/A.

ACTIVITY INSTRUCTIONS



During the activity:

- Use the Verbal Presentation Feedback Form located at Annex AE to record feedback on what the cadet has done well and areas for improvement.
- Ensure that the requested presentation aids are available prior to the start of the activity.
- Ensure that a timekeeper is present to signal the cadets when they near the one-minute mark. If the cadets go over time, note this in their feedback. Abruptly cutting them off may be more damaging than the negative feedback.

1. Brief the cadets on the following instructions for this activity:
 - a. Each cadet is required to deliver a one-minute verbal presentation on a chosen topic.
 - b. Each cadet is permitted to use one piece of paper not larger than 8 1/2 inches by 11 inches for outline notes. Cadets are not permitted to read their presentations directly from the paper.
 - c. No assistance will be provided.
2. Determine the order in which the cadets will deliver their presentations.

3. Have each cadet deliver a presentation. At the end of the presentation, provide one-on-one feedback to the cadet using the Verbal Presentation Feedback Form. Have the next cadet prepare for their presentation while the one-on-one feedback interview is in progress.



Instructions for the one-on-one feedback interview:

1. Conduct in a private setting.
2. Put the cadet at ease.
3. Ask how they think they did.
4. Ask what they think went well. Discuss two positive points about their presentation.
5. Ask what they think needs improvement. Discuss two areas for improvement.
6. Finish the feedback interview on a positive note.

Positive feedback is essential and should take into account that this may be the first time the cadet has delivered a prepared presentation in front of a group.

4. Continue until all the cadets have had the opportunity to present.
5. Summarize the common feedback for the group and discuss how to improve the presentations.



It is essential that the cadets leave the lesson with a positive attitude.

SAFETY

N/A.

CONFIRMATION OF TEACHING POINT 3

The cadets' participation in a one-minute verbal presentation will serve as confirmation for this TP.

END OF LESSON CONFIRMATION

The cadets' participation in a one-minute verbal presentation will serve as confirmation for this lesson.

CONCLUSION

HOMEWORK/READING/PRACTICE

N/A.

METHOD OF EVALUATION

N/A.

CLOSING STATEMENT

Practicing effective speaking techniques in front of peers will build self-confidence and develop presentation skills needed for instructing cadets.

INSTRUCTOR NOTES/REMARKS

TP 3 should be scheduled on a separate training night after TPs 1 and 2 have been conducted.

This EO should be scheduled after EO M309.03 (Describe Effective-Speaking Techniques, Section 3) and before EO M309.06 (Plan a Lesson, Section 6).

REFERENCES

C0-192 (ISBN 0-9695066-2-7) Bender, P. (2000). *Secrets of Power Presentations*. Toronto, ON: The Achievement Group.



**COMMON TRAINING
SILVER STAR
INSTRUCTIONAL GUIDE**



SECTION 9

EO C309.02 – PLAN A LESSON

Total Time:

60 min

THERE IS NO INSTRUCTIONAL GUIDE PROVIDED FOR THIS EO.

THIS PAGE INTENTIONALLY LEFT BLANK



**COMMON TRAINING
SILVER STAR
INSTRUCTIONAL GUIDE**



SECTION 10

EO C309.03 – INSTRUCT A 15-MINUTE LESSON

Total Time:

60 min

THERE IS NO INSTRUCTIONAL GUIDE PROVIDED FOR THIS EO.

THIS PAGE INTENTIONALLY LEFT BLANK



COMMON TRAINING
SILVER STAR
INSTRUCTIONAL GUIDE



SECTION 11

EO C309.04 – IDENTIFY FORMATIONS FOR DRILL INSTRUCTION

Total Time:

30 min

PREPARATION

PRE-LESSON INSTRUCTIONS

Resources needed for the delivery of this lesson are listed in the lesson specification located in A-CR-CCP-703/PG-001, Chapter 4. Specific uses for said resources are identified throughout the instructional guide within the TP for which they are required.

Review the lesson content and become familiar with the material prior to delivering the lesson.

PRE-LESSON ASSIGNMENT

N/A.

APPROACH

An interactive lecture was chosen for TP 1 to introduce the formations used for drill instruction.

A demonstration was chosen for TP 2 as it allows the instructor to demonstrate the procedures for forming a hollow square and reforming the squad.

INTRODUCTION

REVIEW

N/A.

OBJECTIVES

By the end of this lesson the cadet shall have identified the formations for drill instruction.

IMPORTANCE

It is important for cadets to identify formations for drill instruction to be able to select the most effective formation for the lesson being taught. The choice of formation is important because it allows all of the cadets to see the instructor.

Teaching Point 1**Describe the Formations for Drill Instruction**

Time: 5 min

Method: Interactive Lecture

FORMATIONS FOR DRILL INSTRUCTION

The choice of formation is important because it allows all of the cadets to see the instructor. The three formations that are recommended are a single file, a semicircle and a hollow square.

Single File. Used for groups of five cadets or less which can form up into one rank.

Semicircle. Used for groups of six to nine cadets which can be formed up in two ranks. There is no formal drill command for forming a semicircle.

Hollow Square. Used for groups of 10 or more cadets which are formed up in three ranks.

CONFIRMATION OF TEACHING POINT 1

QUESTIONS

- Q1. When is a single file formation used?
- Q2. What formation should be used for a squad in two ranks?
- Q3. How many ranks must the squad be in to form a hollow square?

ANTICIPATED ANSWERS

- A1. Groups of five cadets or less.
- A2. Semicircle.
- A3. Three ranks.
-

Teaching Point 2**Demonstrate the Procedure for Forming a Hollow Square and Reforming a Squad**

Time: 20 min

Method: Demonstration



Proper drill movements shall be combined with a professional demeanour throughout the period of instruction.

Check for faults and correct them immediately when they occur.



Capitalization indicates the words of command for each movement.

FORM HOLLOW SQUARE



The squad shall be in line in three ranks prior to forming the hollow square.

The following procedure is used to form a hollow square (as illustrated in Figure 9-11-1):

1. On the command FORM HOLLOW SQUARE, CENTRE RANK RIGHT, REAR RANK LEFT-TURN, the squad acts as ordered.
2. On the command CENTRE RANK LEFT WHEEL, REAR RANK RIGHT WHEEL, QUICK-MARCH, the squad acts as ordered.
3. The command MARK-TIME shall be given when the rear individuals of the centre and rear ranks are one pace in front of the front rank.
4. On the command SQUAD-HALT, the squad acts as ordered.
5. On the command CENTRE RANK LEFT, REAR RANK RIGHT-TURN, the squad acts as ordered.



Where new cadets may not yet know the movements listed for the forming of a hollow square, instructors should give instructions such as: “*Centre rank turn to your right, rear rank turn to your left*” and then guide the cadets into the correct formation. The use of drill commands where the cadets are unaware of the actions they should take will only serve to create a negative atmosphere for the class.

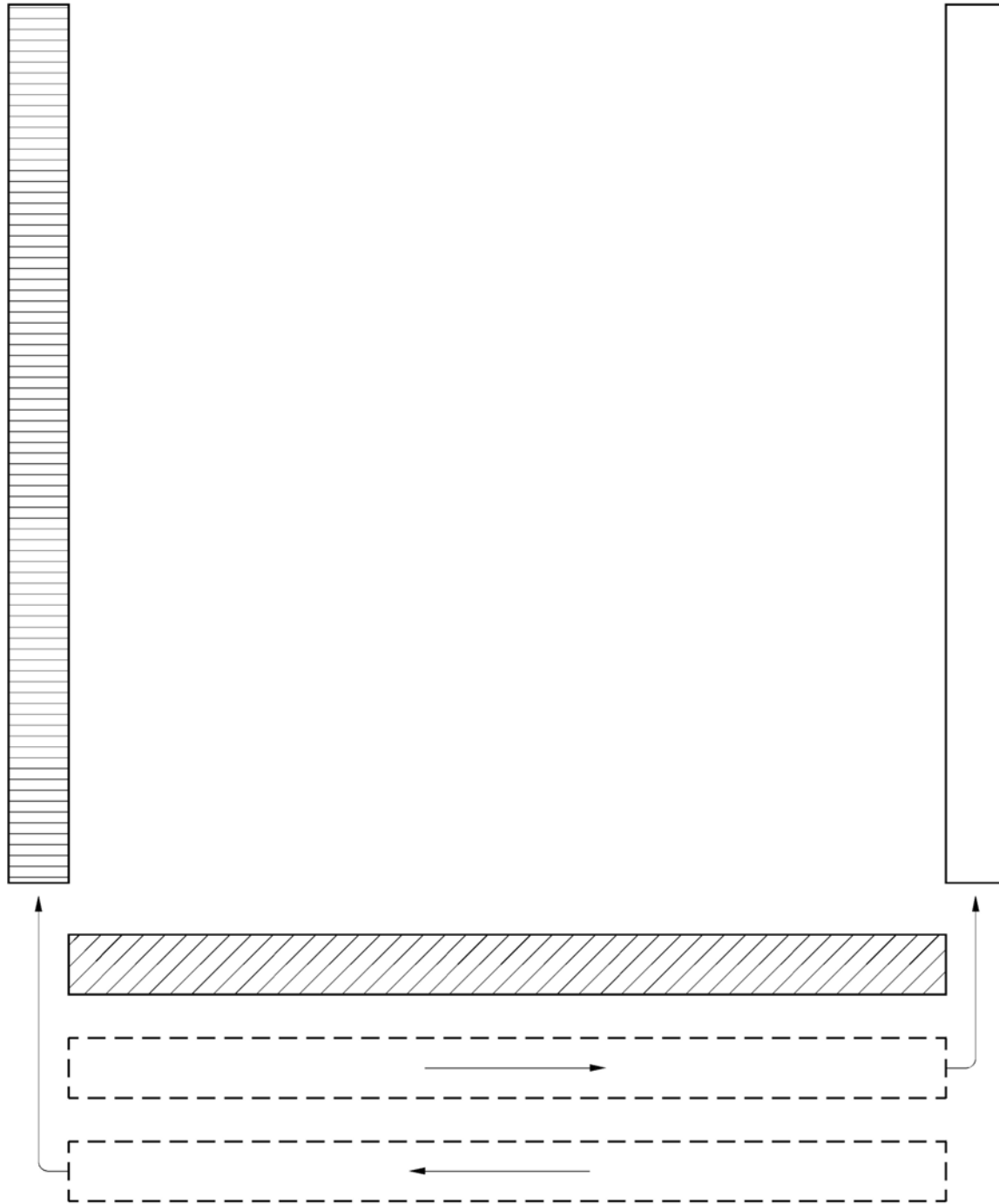

A-PD-201-000/PT-000, *The Canadian Forces Manual of Drill and Ceremonial* (p. 3-23)

Figure 9-11-1 Forming a Hollow Square

REFORM THREE RANKS

 The reverse procedure to forming a hollow square is used to reform a squad into three ranks.

The following procedure is used to reform three ranks:

1. On the command REFORM THREE RANKS, CENTRE RANK LEFT, REAR RANK RIGHT-TURN, the squad acts as ordered.
2. On the command CENTRE RANK RIGHT WHEEL, REAR RANK LEFT WHEEL, QUICK-MARCH, the squad acts as ordered.
3. The command MARK-TIME shall be given when the squad has reformed three ranks.
4. On the command SQUAD-HALT, the squad acts as ordered.
5. On the command CENTRE RANK RIGHT, REAR RANK LEFT-TURN, the squad acts as ordered.



If time permits, have the cadets practice forming a hollow square with their peers. Simulate three ranks for groups less than 10 cadets.

CONFIRMATION OF TEACHING POINT 2

QUESTIONS

- Q1. How must a squad be formed before forming a hollow square?
- Q2. When should the instructor give the command to mark time when forming a hollow square?
- Q3. What procedure is used to reform three ranks?

ANTICIPATED ANSWERS

- A1. In three ranks.
- A2. The rear individuals of the centre and rear ranks are one pace in front of the front rank.
- A3. The reverse procedure to forming a hollow square.

END OF LESSON CONFIRMATION

QUESTIONS

- Q1. What three formations are used for drill instruction?
- Q2. What formation should be used for a group of seven cadets?
- Q3. How many cadets are needed to form a hollow square?

ANTICIPATED ANSWERS

- A1. Single file, semicircle and hollow square.
- A2. Semicircle.
- A3. 10 or more.

CONCLUSION

HOMEWORK/READING/PRACTICE

N/A.

METHOD OF EVALUATION

N/A.

CLOSING STATEMENT

Drill instruction requires the instructor to demonstrate each individual squad of a movement so the cadets can see what is expected. The choice of formation is important because it allows all of the cadets to see the instructor.

INSTRUCTOR NOTES/REMARKS

N/A.

REFERENCES

A0-002 A-PD-201-000/PT-000 Director History and Heritage 3-2. (2005). *The Canadian Forces Manual of Drill and Ceremonial*. Ottawa, ON: Department of National Defence.



COMMON TRAINING
SILVER STAR
INSTRUCTIONAL GUIDE



SECTION 12

EO C309.05 – PLAN A DRILL LESSON

Total Time:

60 min

PREPARATION

PRE-LESSON INSTRUCTIONS

Resources needed for the delivery of this lesson are listed in the lesson specification located in A-CR-CCP-703/PG-001, Chapter 4. Specific uses for said resources are identified throughout the instructional guide within the TP for which they are required.

Review the lesson content and become familiar with the material prior to delivering the lesson.

Photocopy Annexes AF to AI for each cadet.

Photocopy the lesson specifications and instructional guides located at Annexes AJ to AP as required.

PRE-LESSON ASSIGNMENT

N/A.

APPROACH

An interactive lecture was chosen for TPs 1 and 2 to present the drill instruction sequence and to stimulate an interest in planning a drill lesson.

A practical activity was chosen for TP 3 to guide the cadets through the process of planning a drill lesson.

INTRODUCTION

REVIEW

N/A.

OBJECTIVES

By the end of this lesson the cadet shall have identified the drill instruction sequence and written a drill lesson plan.

IMPORTANCE

It is important for cadets to know the essential elements of a drill lesson and be able to develop a written drill lesson plan as it allows them to be better prepared to deliver drill instruction. Drill that is well taught and executed develops individual pride, mental alertness, precision and esprit de corps.

Teaching Point 1**Describe the Drill Instruction Sequence**

Time: 10 min

Method: Interactive Lecture

INTRODUCTION

The lesson shall be introduced as follows:

1. Order the squad into a suitable formation such as a single rank, hollow square or semicircle.
2. Review the previous lesson.
3. Describe the new movement.
4. Describe why it is important to learn the movement.
5. Describe where and when the movement will be used.
6. Describe how the cadets will be assessed.

BODY

The lesson shall be taught using the following process:

1. Demonstrate the complete movement, calling out the time.
2. Explain the complete movement.
3. Demonstrate the first part of the movement (Squad 1).
4. Explain the first part of the movement.
5. Give the squad the opportunity to ask questions.
6. Practice the first movement (collectively, individually, collectively) (as illustrated in Figure 9-12-1).
7. Demonstrate and explain the second part of the movement (Squad 2) and any subsequent parts of the movement (Squads) following Steps 3. to 6.
8. Give two complete demonstrations.
9. Practice the complete movement with:
 - a. the instructor calling the time;
 - b. the squad calling the time; and
 - c. the squad judging the time.

DEMONSTRATE THE COMPLETE MOVEMENT WITH TIMING

The instructor shall provide a complete demonstration of the drill movement, with timing. A practiced assistant instructor may carry out this demonstration.

The demonstration shall be provided from various vantage points, as required.

DEMONSTRATE FIRST PART OF MOVEMENT (FIRST NUMBER)

For ease of instruction, drill commands have been broken down into individual movements, or numbers. The instructor(s) shall demonstrate and explain each number.

In order to adopt the position of attention from stand at ease, the cadet shall:

On the command ATTENTION BY NUMBERS, SQUAD—ONE, bend the left knee and shift the balance to the right foot.

PRACTICE THE SQUAD ON THE FIRST MOVEMENT

Practice the squad on the first movement collectively, individually and collectively.

Director Cadets 3, 2008, Ottawa, ON: Department of National Defence

Figure 9-12-1 Drill Instruction Sequence

END OF LESSON CONFIRMATION

The end of lesson confirmation must meet the following criteria:

1. It shall be a performance of the movement taught.
2. It shall be conducted as a squad.
3. It will emphasize any aspects of the movement that the cadets experienced difficulty with during the lesson.

CONCLUSION

The lesson shall be summarized as follows:

1. Restate the movement taught and where or when it will be used;
2. Re-motivate the cadets by:
 - a. commenting on the cadets' progress; and
 - b. re-stating why the drill movement just learned is important.
3. Describe the next lesson.

CONFIRMATION OF TEACHING POINT 1

QUESTIONS

- Q1. Describe one action an instructor shall take during the introduction of a drill lesson.
- Q2. List the sequence for practicing drill movements.
- Q3. What shall an instructor do in the conclusion of a drill lesson?

ANTICIPATED ANSWERS

- A1. During the beginning of a drill lesson, an instructor shall:
1. Order the squad into a suitable formation.
 2. Review the previous lesson.
 3. Describe the new movement.
 4. Describe why it is important to learn it.
 5. Describe where and when the movement will be used.
 6. Describe how the cadets will be assessed.
- A2. The sequence for practicing drill movements is to practice the squad collectively, individually, collectively.
- A3. In the conclusion the instructor shall:
1. Restate the movement taught and where or when it will be used.
 2. Re-motivate the cadets by commenting on the cadets' progress and by re-stating the reason for learning the movement.
 3. Describe the next lesson.

Teaching Point 2

Review the Lesson-Planning Process

Time: 10 min

Method: Interactive Lecture



Before beginning the activity for planning a drill lesson, review the lesson-planning process taught in M309.06 (Plan A Lesson, Section 6) summarized below.



Distribute the lesson plan handout located at Annex AF to each cadet.

THE LESSON-PLANNING PROCESS

The Canadian Forces employs an initialism that is used to provide a framework for the instructor to gather and organize the reference material into an efficient and practical lesson plan. The initialism is CCSAM.

Collect. During this step, the instructor researches the material to be covered in the period of instruction using course documents such as the lesson specification, IG and listed references. In situations where no course documents exist, the instructor will research the material to be taught using whatever references exist.

Consider. During this step, the instructor sifts through all of the material found in the collection step and determines what is relevant and current.

Select. During this step, the instructor selects the material that is appropriate for the lesson. The instructor also selects the method of instruction to be used.

Arrange. During this step, the instructor arranges the material into stages that allow for the information to be presented in a logical sequence.

Master. During this step, the instructor writes the lesson plan.

LESSON SPECIFICATION

Lesson specifications are found in Chapter 4 of the Qualification Standard and Plan (QSP). The two sections of a lesson specification are the enabling objective (EO) and the lesson specification.

Enabling Objective

The EO is the first three paragraphs of the lesson specification and will answer three questions:

- What will the cadet be expected to be able to do by the end of this lesson?
- Under what conditions will the cadet be expected to carry out the performance?
- How well or to what standard will the cadet be expected to perform?

Lesson Specification

The lesson specification, (paragraphs 4. to 11.), contains information about:

- the content to be taught broken down into teaching points;
- the teaching method(s) to be used and why they were chosen;
- the time for each teaching point (TP);
- the references used;
- the training aids to be used;
- the learning aids to be used;
- the test details; and
- remarks for the instructor.

INSTRUCTIONAL GUIDE (IG)

The IG is used in conjunction with the QSP and other resources to conduct training. IGs should be reviewed in conjunction with lesson specifications so that the instructor can adequately plan and prepare their lesson. The following are the six sections of an IG:

Preparation. This section provides information to the instructor regarding:

- pre-lesson instructions;
- pre-lesson assignment; and
- instructional approach or method.

Introduction. This section provides information to the instructor regarding:

- any review that may be necessary;

- what the cadet will be expected to do by the end of the lesson; and
- why the knowledge/skill is important.

Body. This section provides information to the instructor regarding:

- the TPs and their content as listed in paragraph 4. of the lesson specification in greater detail;
- suggested teaching methods;
- note boxes with special instructions or information;
- lesson content;
- figures;
- activities; and
- confirmation questions or activities.

Conclusion. This section provides information to the instructor regarding:

- any homework/reading/practice that may be required of the cadet;
- the method of evaluation to be used as stated in the lesson specification;
- a closing statement to be spoken aloud to the cadet; and
- any additional instructor notes/remarks.

References. This section lists the sources of information used to create the lesson specification and instructional guide.

Annexes. This section contains background information for the TPs, pre-made instructional aids and additional information for activities.

CONFIRMATION OF TEACHING POINT 2

QUESTIONS

- Q1. List the five parts of the lesson-planning process.
- Q2. What is included in the EO portion of a lesson specification?
- Q3. What are the six sections of an instructional guide?

ANTICIPATED ANSWERS

- A1. The five parts of the lesson planning process are collect, consider, select, arrange and master.
- A2. The information included in the EO is what the cadet will be expected to learn, what materials, supervision and equipment will be available to the cadet and what standard the cadet will be expected to achieve.
- A3. The six sections of an IG are preparation, introduction, body, conclusion, references and annexes.

Teaching Point 3**Supervise and Provide Assistance While the Cadets Plan a Drill Lesson**

Time: 30 min

Method: Practical Activity

In EO C309.06 (Instruct a 15-Minute Drill Lesson, Section 13), the cadets shall be expected to instruct a drill lesson using a lesson plan, the drill instruction sequence and the appropriate drill formation. The lesson plan created in this EO will be used to instruct that drill lesson.



Distribute the blank lesson plan located at Annex AG and the plan a drill lesson checklist located at Annex AH to each cadet.

ACTIVITY**OBJECTIVE**

The objective of this activity is to have the cadets plan a 15-minute drill lesson.

RESOURCES

- List of approved 15-minute drill topics located at Annex AI, and
- Modified lesson specifications and instructional guides located at Annexes AJ to AP.

ACTIVITY LAYOUT

N/A.

ACTIVITY INSTRUCTIONS

1. Have each cadet choose a topic from the list of approved 15-minute drill topics.
2. Have the cadets use the lesson specification and IG for their chosen topic to help develop their drill lesson plan. Cadets shall be expected to teach their chosen lesson as part of C309.06 (Instruct a 15-Minute Drill Lesson, Section 13).
3. Circulate around the room facilitating the activity and helping the cadets as required.



Ensure that cadets request all resources required to instruct their lesson.

SAFETY

N/A.

CONFIRMATION OF TEACHING POINT 3

The cadets' participation in the activity will serve as the confirmation of this TP.

END OF LESSON CONFIRMATION

The cadets' planning a drill lesson will serve as the confirmation of this lesson.

CONCLUSION

HOMEWORK/READING/PRACTICE

The cadets shall be prepared to instruct their lesson at the beginning of C309.06 (Instruct a 15-Minute Drill Lesson, Section 13)

METHOD OF EVALUATION

N/A.

CLOSING STATEMENT

Instructors must continually work to improve the quality of instruction. Being able to plan drill lessons is a critical step in boosting the instructor's confidence and improving the quality of drill instruction.

INSTRUCTOR NOTES/REMARKS

EO C309.05 (Plan a Drill Lesson) should be scheduled at least one week prior to EO C309.06 (Instruct a 15-Minute Drill Lesson, Section 13).

REFERENCES

A0-002 A-PD-201-000/PT-000 Director History and Heritage 3-2. (2005). *The Canadian Forces Manual of Drill and Ceremonial*. Ottawa, ON: Department of National Defence.



COMMON TRAINING
SILVER STAR
INSTRUCTIONAL GUIDE



SECTION 13

EO C309.06 – INSTRUCT A 15-MINUTE DRILL LESSON

Total Time:	90 min
-------------	--------

PREPARATION

PRE-LESSON INSTRUCTIONS

Resources needed for the delivery of this lesson are listed in the lesson specification located in A-CR-CCP-703/PG-001, Chapter 4. Specific uses for said resources are identified throughout the instructional guide within the TP for which they are required.

Review the lesson content and become familiar with the material prior to delivering the lesson.

Photocopy the Drill Instructional Techniques Assessment Form located at Annex AQ for each cadet.

Ensure that all resources requested by the cadets are available.

PRE-LESSON ASSIGNMENT

N/A.

APPROACH

A practical activity was chosen for this lesson as it is an interactive way for cadets to develop drill instructional skills in a safe and controlled environment.

INTRODUCTION

REVIEW

N/A.

OBJECTIVES

By the end of this lesson the cadet shall have instructed a 15-minute drill lesson using a written lesson plan and the drill instruction sequence.

IMPORTANCE

It is important for cadets to instruct a 15-minute drill lesson as it gives them the opportunity to practice drill instructional skills in a peer setting and to receive feedback to further develop instructional skills and confidence.

Teaching Point 1**Supervise While the Cadets Instruct a 15-Minute Drill Lesson**

Time: 85 min

Method: Practical Activity

ACTIVITY

Time: 85 min

OBJECTIVE

The objective of this activity is to have cadets instruct a 15-minute drill lesson in a peer setting using a written lesson plan and the drill instruction sequence.

RESOURCES

Drill Instructional Techniques Assessment Form.

ACTIVITY LAYOUT

N/A.

ACTIVITY INSTRUCTIONS

1. Have the cadets provide a copy of their lesson plan to the assessor.
2. Determine the order in which cadets will instruct their lessons.
3. Have one cadet form up the squad for their drill lesson.
4. Have one cadet instruct a 15-minute drill lesson using a written lesson plan and the drill instruction sequence (as prepared in EO C309.05 [Plan a Drill Lesson, Section 12]).
5. Assess the cadet's lesson using the Drill Instructional Techniques Assessment Form.
6. Upon completion of the lesson, provide feedback to the cadet.
7. Repeat Steps 3. to 6. until all cadets have instructed a lesson.



The Drill Instructional Techniques Assessment Form located at Annex AQ is used to provide feedback on the cadet's lesson and to introduce the cadet to the type of instructional techniques assessment they will receive in their future star level training. The form is intended solely for the purposes of assessment for learning, providing the cadets with the feedback they need to improve upon their own skills.

8. Debrief the cadets by providing feedback, focusing on:
 - a. best practices,
 - b. general trends and key areas for improvement, and
 - c. re-motivation, highlighting the effort and accomplishments of the group.



If the group of cadets is large, divide them up into smaller groups and assign other instructors to aid with assessment and feedback.

SAFETY

N/A.

CONFIRMATION OF TEACHING POINT 1

The cadets' participation in the activity will serve as the confirmation of this TP.

END OF LESSON CONFIRMATION

The cadet's instructing a 15-minute drill lesson will serve as the confirmation of this lesson.

CONCLUSION

HOMEWORK/READING/PRACTICE

N/A.

METHOD OF EVALUATION

N/A.

CLOSING STATEMENT

Practicing drill instructional skills in a peer setting allows for the development of fundamental skills necessary to become a drill instructor while further developing confidence and providing a sense of accomplishment.

INSTRUCTOR NOTES/REMARKS

This EO shall be conducted after EO C309.04 (Identify Formations for Drill Instruction, Section 11) and EO C309.05 (Plan a Drill Lesson, Section 12).

Additional time may be required for class sizes greater than five cadets.

REFERENCES

A0-002 A-PD-201-000/PT-000 Director Heritage and History 3-2 (2005). *The Canadian Forces Manual of Drill and Ceremonial*. Ottawa, ON: Department of National Defence.

THIS PAGE INTENTIONALLY LEFT BLANK

PRINCIPLES OF INSTRUCTION INFORMATION SHEET

INTEREST

Cadets are more receptive to learning when they are curious and have an emotional connection to a topic. The instructor must arouse, create and maintain the interest of the cadets. Without interest, the cadets will be less inclined to listen and will not learn.

- **Principle.** People learn when they are interested in the material or skill.
- **Action.** Instructors must arouse, create and maintain the cadets' interest. The instructor should employ imaginative means to keep curiosity, while taking into account experience and interests.

Ensure Interest	Technique
Information	Inform the cadets why they are learning the skill or knowledge. Explain all of the benefits of this new knowledge or skill.
Enthusiasm	Show enthusiasm. Smile and have fun. Make eye contact. Vary the pitch, resonance, articulation, speed, volume, inflection and rhythm of your speech.
Variety	Use more than one instructor. Use verbal support to back up a statement or to clarify an idea. Use a variety of different training aids. Try different teaching methods.
Realism	Try a different location for your class. If you are teaching judging distance then take your cadets out to a field and place items at different intervals.
Participation	Involve the cadets by asking questions. Ensure cadets participate early in a skill lesson. Use speed and/or ability competitions or games to reinforce learning.

COMPREHENSION

Comprehension or understanding relates to the cadet's ability to understand the material taught. The cadets' readiness to learn new material is influenced by what has previously been taught; new content should not exceed the knowledge level of the cadets. If the cadets do not understand, they are unable to learn.

- **Principle.** People learn when instruction starts at their level of understanding and proceeds at the rate of their comprehension.
- **Action.** Instructors must determine the cadet's level of knowledge and only progress with new material when the cadets have full understanding of the material previously taught.

Ensure Comprehension	Technique
Research	Examine the Qualification Standard and Plan (QSP) to determine what material the cadets have already been taught.
Plan	Organize lesson material in a logical order. Proceed from the known to the unknown. Move from simple material to the more difficult.
Question	Ask review questions at the start of the lesson to determine the level of understanding. Continue to ask questions throughout the lesson to ensure understanding. Assure cadets early in the lesson that questions are welcome.
Observe	Watch for expressions of body language that may indicate difficulty with parts of the lesson. Observe cadets when they practice a skill and correct error as they occur.

EMPHASIS

During a period of instruction there will be some information, which may be of particular importance. The instructor can emphasize this important information through the use of voice control, training aids and in-class activities.

- **Principle.** People retain more important information when the instructor uses repetition and emphasis.
- **Action.** Instructors must stress essential points.

Ensure Emphasis	Technique
Process	Teach the material step by step. Re-cap each area (stress key points). Have the cadets take notes.
In-Class Review	Review the key points from the past lesson. Repeat the key points during the lesson.
Reinforcement	For a knowledge lesson, ask questions on the key points. For a skill lesson, allow sufficient practice time for the cadets to ask questions and receive corrective action. Do not over demonstrate. Try saying "This is important, remember it." Use verbal support by giving examples, to include: <ul style="list-style-type: none"> • comparisons, • reasons, • restatement and repetition, • examples, • statistics, and • testimonials. Use training aids.
Post Lesson	Distribute handouts covering key points.

PARTICIPATION

Cadets are more likely to retain information if they are both mentally and physically involved in learning. The instructor should conduct activities that contain action, activity and excitement. Cadets Learn by doing.

- **Principle.** People learn best when they have an opportunity to participate actively in the learning process. People learn by doing.
- **Action.** The instructor creates class participation in the form of a physical or mental activity.

Ensure Participation in a Knowledge Lesson	Technique
Involvement	Ask open-ended questions that will encourage individual thought and generate a discussion.
Group Work	Select teaching methods that allow the cadets to share ideas and knowledge.
Learning Activity	Organize teaching points to contain such things as: <ul style="list-style-type: none"> • puzzles, • crosswords, • trivia games, • board games, • word searches, • discussions, • case studies, • competitions, • experiments, or • problem solving.
Application	Allow the cadets to apply the knowledge through case studies and problem-based learning.

Ensure Participation in a Skill Lesson	Technique
Involvement	Ensure early involvement by cadets. Have as many cadets as possible working on the skills at the same time.
Practice	Ensure ample practice time. Maintain close supervision during practice

Ensure Participation in a Skill Lesson	Technique
Detection and Correction	Be aware of commonly made errors while practicing a new skill. Observe cadets closely when they practice a skill. Correct errors as they occur. Correct one error at a time.
Competition	Allow the cadets to practice new skills by conducting friendly competitions and contests.

ACCOMPLISHMENT

The lesson must impart a sense of accomplishment to each cadet. The cadets should leave the class with the satisfaction that they were able to achieve something in the lesson.

- **Principle.** People learn most effectively when their performance results in a sense of accomplishment.
- **Action.** The instructor must tell the cadets what they are doing well and what needs improvement. The objective is to offer feedback that will reinforce desired performance and correct undesired performance.

Ensure Accomplishment	Technique
Expectations	Inform cadets of the lesson objectives. Ensure the cadets understand what will be expected of them at the end of the lesson.
Learner Satisfaction	Explain lessons clearly using simple words. The cadets will learn easily creating fulfillment.
Learner Responsibility	Keep cadets informed of their progress. Just by saying “Now that you have all correctly tied the reef knot, let’s practice the bowline” will indicate the cadets’ progress.
Encouragement	Reassure cadets that they will be successful. Compliment cadets on work that is well done.
Perseverance	Encourage cadets who may be having difficulty. Allow cadets to practice skills they have difficulty with. Offer extra help if necessary.

CONFIRMATION

Confirmation is an essential part of learning and instructing. It gives both the instructor and the cadet the opportunity to see how well the information is understood.

- **Principle.** Confirm that learning has occurred and knowledge has been retained.
- **Action.** Instructors must confirm that the cadets' learning meets established standards and ensure that the skills can be performed safely and competently.

Ensure Confirmation	Technique
Practice	Observe as the cadets practice the skills.
Exercise	Have the cadets perform the skill. If you are teaching cadets how to ascend and descend hills when mountain biking, watch each cadet as they demonstrate the skill. Anyone who cannot do it may need extra instruction. Provide exercises or guide discussions that stress the key points of the lesson.
Questions	Ask questions at the end of the lesson to assess how well the cadets are learning. Listen carefully to the cadets' answers. You may be able to identify weak areas that may need to be re-taught.
Assignments	Review assignments completed outside class to determine the extent of learning.
Tests	Conduct confirmation for teaching points and enabling checks. This will also reinforce learning.
Observations	Note and provide feedback on cadet behaviour.

THIS PAGE INTENTIONALLY LEFT BLANK

PRINCIPLES OF INSTRUCTION WORKSHEETS

PRINCIPLES OF INSTRUCTION Worksheet

NAME OF PRINCIPLE: Interest.

TOPIC: How to eat an apple.

TECHNIQUES FOR APPLYING THE PRINCIPLE TO THIS TOPIC:

PRINCIPLES OF INSTRUCTION

Worksheet

NAME OF PRINCIPLE: Comprehension.

TOPIC: How to tie a shoe.

TECHNIQUES FOR APPLYING THE PRINCIPLE TO THIS TOPIC:

PRINCIPLES OF INSTRUCTION

Worksheet

NAME OF PRINCIPLE: Emphasis.

TOPIC: How to cross the street.

TECHNIQUES FOR APPLYING THE PRINCIPLE TO THIS TOPIC:

PRINCIPLES OF INSTRUCTION Worksheet

NAME OF PRINCIPLE: Participation.

TOPIC: How to walk down the stairs.

TECHNIQUES FOR APPLYING THE PRINCIPLE TO THIS TOPIC:

METHODS OF INSTRUCTION

INTERACTIVE LECTURE

Description	Pre-Lesson Preparation	Typical Applications	Lesson Development
<p>Interactive lecture is an instructor-driven method, which combines both lecture and interaction to meet lesson objectives. The lecture portions of the lesson are offset with relevant activities such as videos with discussion, games, learning stations, brainstorming, debating, group work or the completion of handouts.</p>	<p>Use attention-getters such as interesting facts, statistics or rhetorical questions to begin the lecture or to introduce new teaching points.</p> <p>Prepare participatory questions to encourage cadet participation.</p> <p>Prepare evaluative questions for confirmation of teaching points.</p> <p>Obtain or develop training aids to clarify main points.</p> <p>Prepare an in-class activity to avoid lecturing too long.</p> <p>Practice delivering the material.</p>	<p>Interactive lectures can be used with different sizes of groups to:</p> <ul style="list-style-type: none"> • introduce a subject; • present background information; • review previously taught material; • give instructions on procedures; • illustrate the application of rules, principles or concepts; or • introduce a demonstration, discussion or performance. 	<p>Begin the lesson and each new TP with an attention-getter.</p> <p>Use presentation aids such as:</p> <ul style="list-style-type: none"> • flip chart, • whiteboard, and/or • electronic media. <p>Pay attention to signals of alertness, such as:</p> <ul style="list-style-type: none"> • cadets' facial expressions, and • cadets' body language. <p>Deal with alertness problems by:</p> <ul style="list-style-type: none"> • asking for questions; and • posing questions to the group. <p>Use visual training aids at opportune moments.</p> <p>Integrate interesting facts with lesson material to maintain interest.</p> <p>Use participatory questions or a short activity to avoid lecturing too long.</p> <p>Use questions to confirm each teaching point.</p> <p>Confirm the lesson using questions or an activity.</p>

DEMONSTRATION AND PERFORMANCE

Description	Pre-Lesson Preparation	Typical Applications	Lesson Development
<p>Demonstration and Performance</p> <p>During demonstration and performance the cadets observe the instructor performing the task in a demonstration, and rehearse it under the supervision of the instructor.</p> <p>Demonstration Method</p> <p>A method of instruction where the instructor, by actually performing an operation or doing a job, shows the cadet what to do, how to do it and explains why, where and when it is done.</p> <p>Performance Method</p> <p>A method in which the cadet is required to perform, under controlled conditions, the operations, skill or movement being taught.</p>	<p>The instructor must be skilled in the task.</p> <p>Gather all materials necessary to instruct the lesson.</p> <p>Break the task down into smaller sequential steps.</p> <p>Practice the lesson to ensure that steps are accurate and clear.</p> <p>Prepare a handout outlining the steps, if necessary.</p> <p>Organize the training area so that all cadets can:</p> <ul style="list-style-type: none"> • see the demonstration, and • perform the task. 	<p>Demonstration Method</p> <p>Demonstration can be used to:</p> <ul style="list-style-type: none"> • teach hands-on operations or procedures; • teach troubleshooting; • illustrate principles; • teach operation or functioning of equipment; • set standards of workmanship; • explain a theory or concept; or • teach safety procedures. <p>Performance Method</p> <p>Performance can be used to:</p> <ul style="list-style-type: none"> • teach hands-on operations or procedures; • teach operation or functioning of equipment; • teach team skills; or • teach safety procedures. 	<p>Introduce the lesson by demonstrating what the cadets will be able to do at the end.</p> <p>Explain where the skill can be applied and why it is important.</p> <p>Provide a handout outlining the steps if the process is complex.</p> <p>Explain and demonstrate each step in a sequential manner.</p> <p>Allow cadets maximum time to practice the steps as soon as possible.</p> <p>Positively reinforce everything the cadets do correctly.</p> <p>Supervise the cadets as they practice, providing assistance or re-demonstrations when necessary.</p> <p>Have cadets perform the skill as confirmation.</p> <p>Encourage the cadets to practice beyond class time.</p>

IN-CLASS ACTIVITY

Description	Pre-Lesson Preparation	Typical Applications	Lesson Development
<p>In-class activities encompass a wide variety of activity-based learning opportunities that can be used to reinforce and practice instructional topics or to introduce cadets to new experiences. In-class activities should stimulate interest among cadets and encourage their participation, while maintaining relevance to the performance objectives. Examples of in-class activities include learning stations, videos, brainstorming, debating, and group work.</p>	<p>Create an activity that involves all cadets, which can be conducted within the time allocated.</p> <p>Clearly specify the objective of the activity.</p> <p>Obtain all materials necessary to complete the activity.</p> <p>Write out specific instructions describing what participants are supposed to do.</p> <p>Write out specific directions for conducting the activity.</p> <p>Arrange for assisting staff, if necessary, to help conduct the activity.</p> <p>Prepare handouts for cadets containing background information.</p> <p>Organize the training area into work/learning stations.</p>	<p>An in-class activity can be used for both knowledge and skill lessons to:</p> <ul style="list-style-type: none"> • reinforce instructional objectives; • introduce a subject and generate interest; • present background information; • give direction on procedures; • introduce a demonstration, discussion or performance; • illustrate the application of rules, principles or concepts; • to create interactivity during a lecture; or • to review, clarify or summarize information. 	<p>Introduce the activity to the whole group.</p> <p>Brief participants on what will be expected of them.</p> <p>Stress timings.</p> <p>Ensure all resources are available.</p> <p>Begin the activity.</p> <p>Supervise and assist the groups as required.</p> <p>Conclude the activity.</p> <p>Confirm the TP or lesson.</p> <p>Debrief the cadets.</p>

PRACTICAL ACTIVITY

Description	Pre-Lesson Preparation	Typical Applications	Lesson Development
<p>Practical activities encompass a wide variety of activity-based learning opportunities that can be used to reinforce and practice instructional topics or to introduce cadets to new experiences. Practical activities should stimulate interest among cadets and encourage their participation, while maintaining relevance to the performance objective.</p>	<p>The instructor must be skilled in the task.</p> <p>Gather all materials necessary to instruct the lesson.</p> <p>Organize the training area so that all cadets will have space to perform the task safely.</p> <p>Ensure there is enough time to conduct the complete activity or breakdown the task into smaller stages.</p> <p>Prepare a handout outlining the steps, if necessary.</p> <p>Arrange for assisting staff, if necessary.</p> <p>Divide cadets into small groups.</p>	<p>The objective of the practical activity method is to reinforce and practice instructional topics or to introduce the cadets to new experiences.</p> <p>If it is used to teach new material it must be combined with other methods to ensure cadets have the necessary background information to complete the activity.</p> <p>The practical activity method can be used to:</p> <ul style="list-style-type: none"> • carry out an application; • demonstrate a process; • verify an explanation; • produce a product; • introduce a subject; • teach manipulative operations; • teach procedures; • teach troubleshooting; • illustrate principles; • teach equipment operation; or • teach safety. 	<p>Review background information.</p> <p>Distribute the handout, if necessary.</p> <p>Introduce the activity to the group.</p> <p>Stress safety.</p> <p>Brief the cadets on what they will be expected to do.</p> <p>Brief assisting staff on what they will be expected to do.</p> <p>Begin the activity.</p> <p>Supervise the cadets and provide assistance, if necessary.</p> <p>Watch for safety infractions and stop the activity, if necessary.</p> <p>Conclude the activity.</p> <p>Debrief the cadets.</p>

GAME

Description	Pre-Lesson Preparation	Typical Applications	Lesson Development
<p>Games are used with one or more participants to practice skills, apply strategies and enhance teams. It is critical that the game supports learning through a challenging activity that allows for skill practice or knowledge confirmation.</p>	<p>Develop a simple game with the following characteristics:</p> <ul style="list-style-type: none"> • fast to play, • easy and quick to organize, • has few rules, • uses minimal equipment, and • involves maximum participation. <p>If possible use variations of games cadets know from childhood or television.</p> <p>Determine the following when developing the rules of the game:</p> <ul style="list-style-type: none"> • individual or team play, • how to change leaders, • what the leader will do, • what the followers will do, • timings for the game, • how to signal the start and stop of the game, • how to ensure safety. <p>Obtain the resources needed to play the game.</p> <p>Organize the training area to play the game.</p>	<p>Games create variety and arouse interest but must also support learning.</p> <p>Games can be used to:</p> <ul style="list-style-type: none"> • introduce a topic; • discover concepts and principles; • learn terminology; • recall terms; • recognize equipment parts; • develop strategies and tactics; • carry out an application; • demonstrate a process; • practice interpersonal skills; and/or • confirm learning 	<p>Brief the cadets on the following:</p> <ul style="list-style-type: none"> • the objective of the game, and • rules of the game. <p>Play the game.</p> <p>Supervise closely to:</p> <ul style="list-style-type: none"> • ensure that the game is played in the manner expected; • ensure that the game is played safely; and • ensure maximum participation. <p>End the game.</p> <p>Debrief the cadets.</p>

FIELD TRIP

Description	Pre-Lesson Preparation	Typical Applications	Lesson Development
<p>Theoretical knowledge is reinforced through participation in an activity in a real-life setting. Prior planning helps to ensure all pre-training and safety standards are met. Field trip activities are planned and carried out to achieve clear instructional objectives that are understood by the cadets. Examples include trips to areas of local interest, flying/gliding, hiking and/or sailing.</p>	<p>Specify the objective(s) of the field trip.</p> <p>Determine the time and location of the field trip.</p> <p>Obtain necessary authorizations.</p> <p>Determine the timings.</p> <p>Determine the activities or demonstrations needed to achieve the objectives.</p> <p>Determine if trained personnel will be available to assist.</p> <p>Arrange the following, if necessary:</p> <ul style="list-style-type: none"> • transportation, • supervision, and • meals. <p>Determine if the cadets will be allowed to use equipment or participate in a training activity.</p> <p>Determine if all cadets can take part at once or if they need to be rotated through.</p> <p>Divide the cadets into groups, if necessary.</p> <p>Ensure safety.</p>	<p>The field trip is used to:</p> <ul style="list-style-type: none"> • introduce/illustrate and confirm topics; • reinforce and clarify classroom learning; • inject variety into the training situation; or • allow cadets to view operations or equipment that cannot easily be shown in the classroom. 	<p>Inform cadets as soon as possible of the following:</p> <ul style="list-style-type: none"> • time of the field trip, • location of the field trip, and • timings for departure. <p>Brief cadets on the following prior to departure:</p> <ul style="list-style-type: none"> • objectives of the field trip, • timings and groupings for activities and demonstrations, and • how they will participate during the field trip. <p>During the field trip ensure the following:</p> <ul style="list-style-type: none"> • the safety of all cadets, • maximum participation, and • the objectives are met. <p>After the field trip:</p> <ul style="list-style-type: none"> • debrief the cadets; and • confirm that objectives have been met. <p>Express appreciation to the facilitators of the field trip.</p>

SELECT A METHOD OF INSTRUCTION

Lesson Topic	Method of Instruction	Explanation
Participate in a Discussion on Hygienic Practices During Physical Activity		
Identify the Parts and the Characteristics of the Daisy 853C Air Rifle		
Apply Basic Marksmanship Techniques		
Participate in a Discussion on Year One Training		
Wear the Army Cadet Uniform		
Participate in a Discussion of Year One Summer Training Opportunities		
Describe the History and Traditions of the Affiliated Unit		
Tie Knots and Lashings		
Assemble a Survival Kit		
Erect a Group Tent		
Discuss Leadership Within A Peer Setting		
Identify Types of Maps		
Orient a Map by Inspection		
Select Trekking Gear		
Identify the Rank Structure of the Royal Canadian Sea, Army and Air Cadets		

THIS PAGE INTENTIONALLY LEFT BLANK

POSING QUESTIONS SEQUENCE

Question Sequence	Action
Pose the Question	The instructor must ensure that they have the full attention of the class and ask a question that is clearly heard by all.
Pause	The instructor must allow cadets time to think of a response. Do not waste time, but avoid answering the question for the cadets just to break the silence.
Pounce	When using a direct question the instructor must indicate which cadet will answer.
Ponder	The instructor must allow the cadets time to answer fully, listen carefully to the response, confirm the correct response and explain why it is correct. If an answer is incomplete, the instructor must emphasize what is correct and ask a follow-up question to complete the response or simply provide additional information. If an answer is incorrect the instructor must point that out as well, in a manner that does not embarrass the cadet and explain why the answer is incorrect. There may be a need to reword the question to get a better response.
Praise	The instructor must praise all cadets for participating and confirm/summarize all correct responses so as to avoid confusion regarding which responses were correct or incorrect.

THIS PAGE INTENTIONALLY LEFT BLANK

QUESTIONS HANDOUT

Read the short passage to the group and ask them to remember the children's story "Goldilocks and the Three Bears."

Once upon a time there was a little girl named Goldilocks. She went for a walk in the forest. Pretty soon, she came upon a house. She knocked and, when no one answered, she walked right in.

- Q. Who do you think lived in the house in the forest?
- A. The three bears.
- Q. What did Goldilocks first do when she entered the house?
- A. She tasted the porridge.
- Q. Whose chair did Goldilocks break?
- A. Little bear's chair.
- Q. Why did Goldilocks go upstairs to the bedroom?
- A. She felt tired.
- Q. Did Goldilocks ever return to the house in the forest?
- A. No.

THIS PAGE INTENTIONALLY LEFT BLANK

POSING QUESTIONS RUBRIC

Standard

Effective Questioner: Follows posing questions sequence when asking questions.

Performance Task

Ask a recall question to the group about the children’s story, “Goldilocks and the Three Bears” using the posing questions sequence.

Performance Element	Met the Standard (Level 3)	Met the Standard With Difficulty (Level 2)	Did Not Meet the Standard (Level 1)
Pose the question	Had the attention of the group. Asked the question clearly.	Had the attention of the group. Did not ask the question clearly.	Did not get the attention of the group. Did not ask the question carefully.
Pause	Allowed cadets ample time to think of a response. Did not waste time. Did not answer the question for the cadets.	Unsure of how much time to allow for a response.	Allowed too much/too little time for a response. Answered the question for the cadet.
Pounce	Pointed to a cadet.	Had to be told to point to a cadet.	Allowed anyone to answer.
Ponder	Allowed cadet to answer fully. Confirmed correct response. Explained incorrect answer.	Allowed cadet to answer fully. Confirmed correct response after being prompted. Explained incorrect response after being prompted.	Did not allow cadet to answer fully. Did not confirm correct response after being prompted. Did not explain incorrect response after being prompted.
Praise	Ensured all cadets participated. Praised correct response appropriately. Clarified any confusion regarding responses.	Ensured all cadets participated. Had to be prompted to praise correct response. Had to be prompted to clarify confusion regarding responses.	Did not ensure all cadets participated. Failed to praise correct responses. Did not clarify lingering confusion regarding responses.

THIS PAGE INTENTIONALLY LEFT BLANK

POSING QUESTIONS CHECKLIST

Place a check mark in the appropriate box.

Name	Pose the Question			Pause			Pounce			Ponder			Praise		
	Level 1	Level 2	Level 3	Level 1	Level 2	Level 3	Level 1	Level 2	Level 3	Level 1	Level 2	Level 3	Level 1	Level 2	Level 3

THIS PAGE INTENTIONALLY LEFT BLANK

COMMON INSTRUCTIONAL AIDS

INSTRUCTIONAL AIDS

HOW INSTRUCTIONAL AIDS WORK

During the communication process, the brain filters the important pieces of information from the less significant pieces. What is considered to be the most important information is passed to the short-term memory for possible storage into the long-term memory. Instructional aids support learning by highlighting and emphasizing the most important pieces of information for the brain to store in memory.

Instructional aids also:

- attract and hold the cadets' attention;
- involve the two most important senses – sight and sound; and
- help instructors teach more in less time.

CHARACTERISTICS OF INSTRUCTIONAL AIDS

Instructional aids should:

- support the lesson by emphasizing and clarifying important information;
- keep the cadets' attention on the topic;
- contain quality pictures, graphs or text;
- be simple and easy to use; and
- be large enough to be seen and loud enough to be heard.

GUIDELINES FOR USING INSTRUCTIONAL AIDS

During the lesson planning stage the following process can be used to determine if and where instructional aids are necessary:

- clearly establish the lesson objective – the information to be communicated or the task to be accomplished;
- research supporting material to achieve the lesson objective;
- organize the material into a lesson plan; and
- select the important points to be supported by instructional aids.



Instructional aids should be used only if they support learning and should not be made visible until the appropriate time during a lesson so as not to become a distraction.

VERBAL SUPPORT

Almost all ideas need some sort of clarification, explanation or proof to be understood. If cadets are learning something new, they want proof to support what is being said. The lesson topic, the instructional method, the cadets' background knowledge and the size of the group are factors that determine how much learning support is required.

Verbal support is one type of support instructors use to clarify, prove, illustrate, emphasize or to add variety and interest to information during a lesson. Types of verbal support include:

- **COMPARISONS**

A comparison is a bridge built by the instructor between the known and the unknown. New information can be clarified by pointing out its similarity to a familiar topic, idea or situation. A factual comparison clarifies by highlighting how two or more related things are similar. For example, a factual comparison is used when the **similarities** between two or more different types of uniforms are highlighted. A contrast clarifies by highlighting how two or more things are different. A contrast is used when the **differences** between two or more types of uniforms are highlighted. Figurative comparisons use similes and metaphors to add variety and gain attention. A figurative comparison is used when expressions such as the “ship cut through the water like a knife” or “the ship knifed through the water” are used to indicate the ship’s speed.

- **REASONS**

Reasons are logical explanations that satisfy the question “why”. Explaining the reason for something often makes it easier for the cadets to accept what is being explained. When instructors cite “safety concerns” as the reason why a task must be completed a certain way, they are using reasons as verbal support.

- **RESTATEMENT AND REPETITION**

Instructors can emphasize main ideas or key points by repeating them. One way to repeat something is to restate it in a different way. Skillful repetition can also persuasively help cadets accept an idea or point of view. Sometimes directions or instructions need to be repeated many times without change for clarity.

- **EXAMPLES**

An example is a specific instance of a general idea used to clarify or simplify information. It should be short and specific and in the cadets' background knowledge so that the cadets can associate new information with something already known.

- **STATISTICS**

Statistics are a summary of numerical information about an event or thing. If properly used, statistics help instructors prove or emphasize main points and create interest in the information. Do not assume, however, that verbal support is being used every time a number or figure is quoted. For example, saying “last year’s national budget for cadets was approximately \$180 million” is a statement of fact but saying “last year’s cadet budget was approximately \$3 000.00 for every cadet in Canada” is using statistics to emphasize the point that the cadet budget is large.

- **TESTIMONY**

Testimony is simply using the experiences, words and thoughts of others to emphasize or prove points. Testimonials are believable because they are offered by experts or people with first- hand knowledge. For

example, simply saying, “the cadet organization offers many advantages to youth” is not as powerful as quoting or hearing from cadets who have gone through the program and realized its benefits.



The acronym **CRREST** can be used to remember the different types of verbal support.

AUDIOVISUAL AIDS

Instructional aids appeal to all five senses. Audiovisual aids are particularly effective because individuals learn and retain over 50 percent of what they both see and hear.

MODELS

A model is a copy of a real object and can be an enlargement, a reduction or the same size as the original. Two types of models are:

- the scale model which is an exact reproduction of the original, and
- the simplified model, which does not represent reality in all details.



As instructional aids, models are usually more practical than the real object because they are lightweight and easy to manipulate.

Mock-Ups

A mock-up is a three dimensional or specialized type of working model and is used for study, training or testing in place of the real object, which may be too costly, too dangerous or impossible to obtain. The advantage of the mock-up over the real thing is that the mock-up may emphasize the essential elements to be learned by distinguishing them from non-essential elements.

Cut-Aways

Some models are solid and show only the outline of the object while others can be manipulated or operated. Specialized models, called cut-aways, are built in sections and can be taken apart to reveal an internal structure. Whenever possible, the various parts should be labelled and coloured to clarify relationships.



Production and equipment costs are limiting factors in developing and using models, mock-ups and cut-aways. If a two-dimensional representation will satisfy the instructor's needs it should be used.

THE REAL OBJECT AND REALISTIC IMAGES

The real object is often the most effective visual aid. To be effectively used the real object should be safe and big enough for everyone to see or small enough and available enough for each cadet to have one. Realistic images, including quality photographs or drawings of the real object, are suitable replacements if the real object cannot be obtained or effectively used.



Realistic images and objects are most effective when they are used after a teaching point has been introduced.

GRAPHICS

Graphics, which include charts, graphs, maps, diagrams, drawings and cartoons, can be used to clarify relationships between concepts or effectively explain a concept that would otherwise require a lengthy description.



Graphics catch the cadets' attention and stimulate thinking by:

- presenting one idea;
- avoiding too many details; and
- using colours, which contrast with the background to emphasize main points.

PROJECTED MATERIAL

Projected material includes videotapes, DVDs and slides projected by an overhead projector or computer. Short, high-quality video presentations have become one of the most popular instructional aids.

Passive video, which includes VHS, DVDs and slides, provides motion, colour, sound and in some cases special advanced graphic and animation techniques. The availability, low cost and user-friendly characteristics are important advantages of passive video but instructors should be aware it is often difficult for instructional video to compete with the action-packed entertainment videos and is often considered less exciting and stimulating by cadets. This, in addition to the cadets' passive viewing style for entertainment videos, can diminish the instructional value of the video.

To increase the value of passive video for instructional purposes, instructors should follow these basic guidelines:

- preview the video to determine the important points and concepts;
- prepare the cadets for viewing the video by stressing what is important to watch; and
- summarize the presentation and answer any questions the cadets may have.



Video presentations are not designed to replace the instructor.

Videotapes and DVDs are generally purchased but slides can easily be developed by hand or by using a computer.

Guidelines for developing slides are:

- illustrate key points;
- use key words or phrases as headers for each slide;
- include a maximum of six words per line and six lines per slide; and
- use lettering large enough to be clearly read from the back of the classroom.



Use of projected materials requires planning and practice. Instructors should set up and adjust the equipment and lighting beforehand and always preview the presentation.

Interactive video refers to software that responds to choices and commands by the user. A typical system consists of a combination of a compact disk and computer with video presentation capability. The software may include image banks of colour photos and graphics as well as questions or directions, which are programmed to create interactivity for students as they progress through the course.



Interactive video solves one of the main problems of passive video in that it increases the cadets' involvement in the learning process. Each cadet receives a customized learning experience.

SIMULATORS

Simulators are mechanical or electronic devices that act like the actual equipment or systems and provide the cadets with realistic practice in a safe and controlled environment. They may have various capabilities such as jump, freeze, record and replay which can capture and playback information for instructional feedback. Simulators replicate the real thing at a fraction of the cost.

Some concerns include:

- the need for the provision of background information,
- the requirement for hardware and software maintenance,
- the need for expertise to run the simulator, and
- the need for specialized facilities.

Some of the more commonly recognized simulators include flight simulators, driver training simulators and marine simulators, which simulate normal and emergency situations, which would otherwise be encountered in real life.

TRAINING EQUIPMENT

Training equipment refers to the use of actual equipment such as boats, air rifles, or gliders for training purposes. The main advantage of this type of aid is that it is the actual piece of equipment or system that the cadet will be expected to use. Despite the benefits of simulators, training is not complete without intensive training in or with the real thing.

Some concerns include:

- the need for subject matter experts,
- the high maintenance costs,
- the need for modifications for instructional purposes, and
- scheduling difficulties caused by external factors such as weather and the availability of the resources.

In short, cadets will only learn to sail, fly or complete an expedition by using a sailboat or glider or travelling to the field.

SELECT AN INSTRUCTIONAL AID

GUIDELINES FOR SELECTING INSTRUCTIONAL AIDS

During the lesson planning stage the following process can be used to determine if and where instructional aids are necessary:

- clearly establish the lesson objective – the information to be communicated or the task to be accomplished;
- research supporting material to achieve the lesson objective;
- organize the material into a lesson plan; and
- select the important points to be supported by instructional aids. Instructional aids are appropriate when:
 - long segments of technical description are necessary;
 - a point is complex and difficult to put into words;
 - instructors find themselves forming visual images; and
 - students are puzzled by an explanation or description.

The selection of instructional aids depends on several factors, which include:

- **Availability.** Which ready-made aids are available? What resources are available to make instructional aids?
- **Facilities.** Does the training area or equipment available allow the instructor to use certain instructional aids?
- **Cost.** Are the instructional aids too expensive to purchase or produce?
- **Class Size.** Does the number of people in the class make the use of the instructional aid practical? Does the instructional aid encourage cadet participation?



Instructional aids should be used only if they support learning and should not be a distraction.

INSTRUCTIONAL AIDS WORKSHEETS

INSTRUCTIONAL AIDS Worksheet

1. How do instructional aids support learning?

2. In your opinion, what is the most important characteristic of instructional aids?

3. When should instructional aids be used during a lesson?

VERBAL SUPPORT Worksheet

Match Column A with Column B by placing the correct number from Column B opposite the correct phrase from Column A.

Column A

- a. a bridge between the known and unknown _____
- b. numerical information about an event or thing _____
- c. can be used to persuade the cadets to accept an idea _____
- d. a specific instance of a general idea _____
- e. logical explanations that satisfy the question "why" _____
- f. using the words of others to prove a point _____
- g. highlighting how two or more things are different _____

Column B

- 1. testimony
- 2. reasons
- 3. comparison
- 4. statistics
- 5. repetition
- 6. example
- 7. contrast

AUDIOVISUAL AIDS

Worksheet

COMPLETE THE CROSSWORD PUZZLE

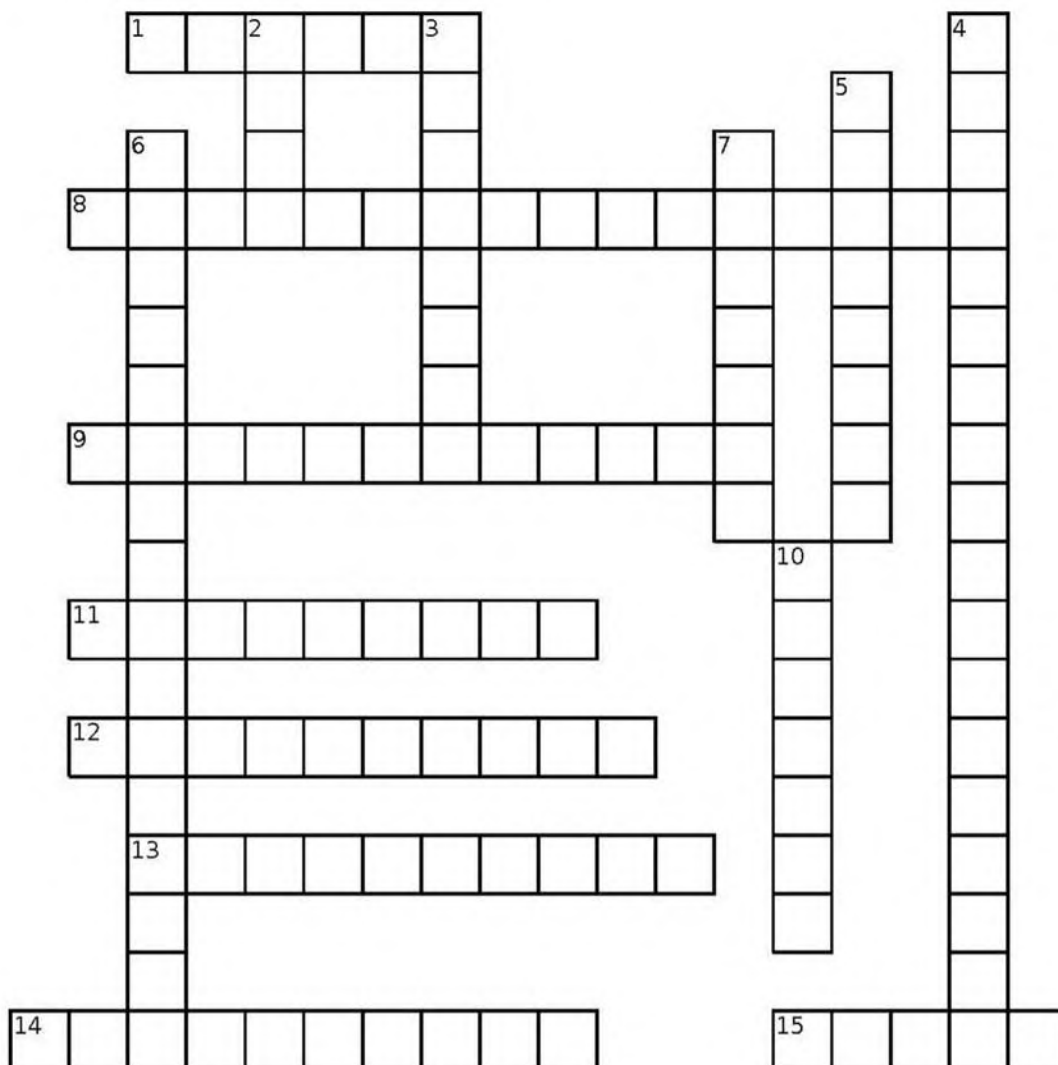

CROSSWORD PUZZLE CLUES

ACROSS

1. a specialized type of working model (2 words)
8. appeals to all five senses (2 words)
9. video, which lacks cadet involvement (2 words)
11. one type of projected material (2 words)
12. the most effective visual aid (2 words)
13. video presentations should not replace the ...
14. an example of a realistic image
15. copy of the real object

DOWN

2. a limiting factor in developing models
3. use of projected material requires planning and ...
4. instructional aids are most effective when they are ... (5 words)
5. can effectively replace a lengthy explanation
6. software that responds quickly to commands (2 words)
7. an example of a graphic instructional aid
10. a model that can be taken apart (2 words)

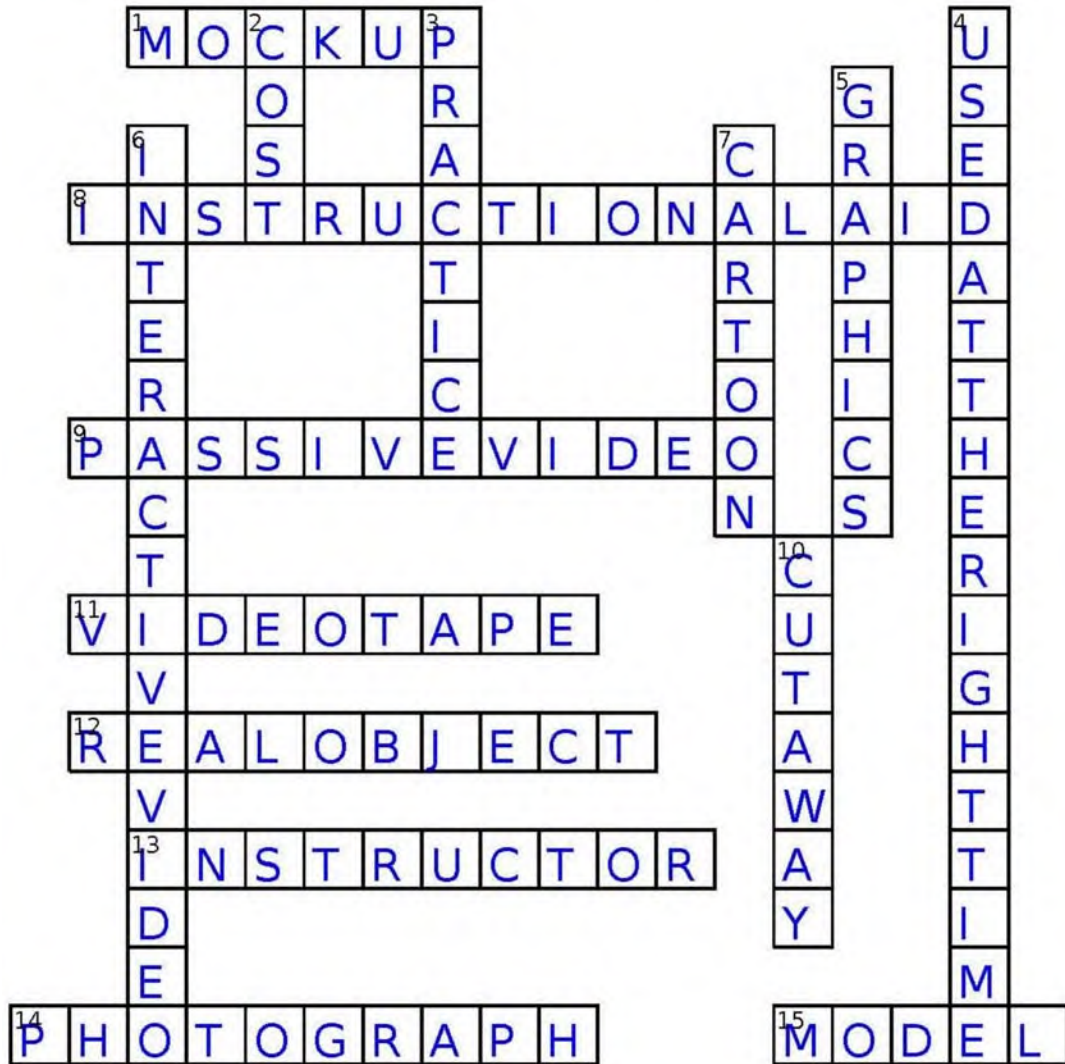

SIMULATORS AND TRAINING EQUIPMENT

Worksheet

1. What do simulators provide the cadets?

2. List four concerns about simulators.

3. What is the main advantage of training equipment as an instructional aid?

4. List four concerns about training equipment.

SELECT AN INSTRUCTIONAL AID Worksheet

Using the “Select an Instructional Aid” information sheet, select an instructional aid you would consider appropriate for each of the topics listed below.

Lesson Topic	Type of Instructional Aid
Participate in a Discussion on Hygienic Practices During Physical Activity	
Identify the Parts and the Characteristics of the Daisy 853C Air Rifle	
Apply Basic Marksmanship Techniques	
Participate in a Discussion on Year One Training	
Wear the Army Cadet Uniform	
Participate in a Discussion of Year One Summer Training Opportunities	
Describe the History and Traditions of the Affiliated Unit	
Tie Knots and Lashings	
Assemble a Survival Kit	
Erect a Group Tent	
Discuss Leadership Within A Peer Setting	
Identify Types of Maps	
Orient a Map by Inspection	
Select Trekking Gear	
Identify the Rank Structure of the Royal Canadian Sea, Army and Air Cadets	

THIS PAGE INTENTIONALLY LEFT BLANK

LESSON SPECIFICATION AND INSTRUCTIONAL GUIDE HANDOUT

ENABLING OBJECTIVE AND LESSON SPECIFICATION

Performance objectives are broken down into a series of enabling objectives and lesson specifications. The enabling objective consists of Paragraphs 1. to 3. (as illustrated in Figure 9K-1). The information in these paragraphs will answer three questions:

1. What will the cadet be expected to be able to do by the end of this lesson?
2. Under what conditions will the cadet be expected to carry out the performance?
3. How well or to what standard will the cadet be expected to perform?

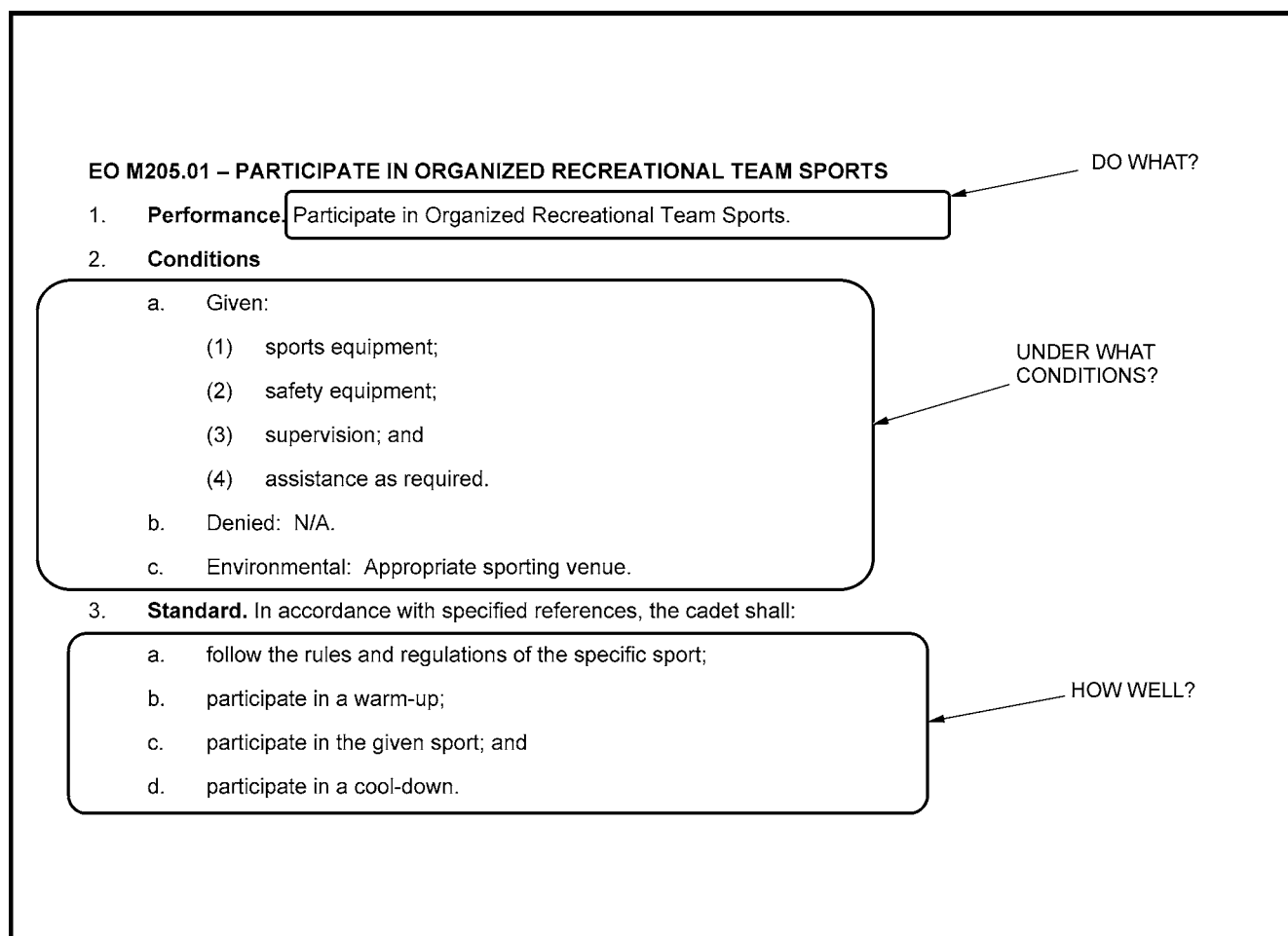

Director Cadets 3, 2008, Ottawa, ON: Department of National Defence

Figure 9K-1 Enabling Objective

Paragraphs 4. to 11. are known as the lesson specification. The lesson specification provides information about the content to be taught, teaching methods, time, references, training aids, learning aids, test details and remarks.

In Paragraph 4., the TPs are usually described in a table where information is provided on the content taught in each TP, the suggested teaching method, the time for each TP and references (as illustrated in Figure 9K-2).

4. Teaching Points

TP	Description	Method	Time	Ref
TP1	Introduce cadets to a specific sport's rules and regulations, to include: a. an overview of how to play the sport; and b. rules and regulations of the sport.	Interactive Lecture	10 min	C0-001
TP2	Conduct a warm-up session, composed of light cardiovascular exercises, meant to: a. stretch the muscles; b. gradually increase respiratory action and heart rate; c. expand the muscles' capillaries to accommodate the increase in blood circulation; and d. raise muscle temperature to facilitate reactions in muscle tissue.	Practical Activity	10 min	C0-002 (pp. 109 to 113) C0-089
TP3	Supervise the cadets' participation in a given sports activity.	Practical Activity	50 min	

Annotations in the diagram:
 - "CONTENT TO BE TAUGHT" points to the Description column.
 - "LENGTH OF TP" points to the Time column.
 - "REFERENCE NUMBER" points to the Ref column.
 - "SUGGESTED TEACHING METHOD" points to the Method column.

Director Cadets 3, 2008, Ottawa, ON: Department of National Defence

Figure 9K-2 Teaching Points

Paragraph 5. outlines how much time is spent on the introduction/conclusion and the different teaching methods. Paragraph 6. offers substantiation or reasons why certain teaching methods were recommended for each TP. Paragraph 7. provides a list of references used to compile the content in Paragraph 4. (as illustrated in Figure 9K-3).

<p>5. Time</p> <p>a. Introduction/Conclusion: 10 min</p> <p>b. Interactive Lecture: 10 min</p> <p>c. Practical Activity: 70 min</p> <p>d. Subtotal: 90 min</p> <p>e. Total (three sessions): 270 min</p> <p>6. Substantiation</p> <p>a. An interactive lecture was chosen for TP1 to illustrate the application of rules, principles, or concepts of the specific sport to be played.</p> <p>b. A practical activity was chosen for TP2 to TP4 as it allows cadets to participate in sports activities in a safe and controlled environment. This activity contributes to the development of sports skills in a fun and challenging setting.</p> <p>7. References</p> <p>a. C0-001 (ISBN 0-88011-807-5) Hanlon, T. (1998). <i>The Sports Rules Book: Essential Rules for 54 Sports</i>. USA: Human Kinetics Publishers, Inc.</p> <p>b. C0-002 (ISBN 0-88962-630-8) LeBlanc, J., and Dickson, L. (1997). <i>Straight Talk About Children and Sport: Advice for Parents, Coaches, And teachers</i>. Oakville, ON and Buffalo, NY: Mosaic Press.</p>
--

Director Cadets 3, 2008, Ottawa, ON: Department of National Defence

Figure 9K-3 Paragraphs 5. to 7.

Paragraphs 8. and 9. list the training aids and learning aids required for the lesson. Training aids are the materials that are required by the instructor to instruct the lesson and learning aids are the materials that will be required by the cadet to participate in the lesson (as illustrated in Figure 9K-4).

<p>8. Training Aids</p> <p>a. Sports/safety equipment appropriate for the activity;</p> <p>b. First aid kit;</p> <p>c. Whistles; and</p> <p>d. Stopwatch.</p> <p>9. Learning Aids. Sports equipment.</p>
--

Director Cadets 3, 2008, Ottawa, ON: Department of National Defence

Figure 9K-4 Training Aids and Learning Aids

Paragraph 10. is test details, which is information about the evaluation to be conducted. Paragraph 11. is remarks, which describe any other information that may be useful to the Training Officer or instructor (as illustrated in Figure 9K-5).

10. Test Details. N/A.
11. Remarks
a. The CCO list of approved sports is located at A-CR-CCP-702/PF-001, Chapter 5, Annex A.
b. Recreational sports can be carried out as nine periods during a supported day or over three sessions of three periods each.

Director Cadets 3, 2008, Ottawa, ON: Department of National Defence

Figure 9K-5 Test Details and Remarks

INSTRUCTIONAL GUIDE

The IG is used in conjunction with the QSP and other resources to conduct training. IGs should be reviewed in conjunction with lesson specifications so that the instructor can adequately plan and prepare their lesson. IGs do not replace lesson plans but offer written content, supporting figures and suggestions on how to instruct a lesson. The following are the six sections of an IG:

1. preparation,
2. introduction,
3. body,
4. conclusion,
5. references, and
6. annexes.

Preparation

The preparation section provides information about where to find the lesson specification and any instructions to the instructor such as reviewing lesson content, photocopying handouts, pre-lesson assignments and the approach and substantiation as to why certain teaching methods were recommended for each TP.

Introduction

The introduction section provides information to the instructor about review that may be necessary, what the cadet will be expected to do by the end of the lesson and why the knowledge/skills are important.

The Body

The body of the IG contains all of the TPs and content listed in Paragraph 4. of the lesson specification in greater detail. The body provides suggested teaching methods, note boxes with special instructions or information (as illustrated in Figure 9K-6), lesson content, figures, activities and confirmation questions.

Note Boxes:



Special note to the instructor.



key information to pass along to the cadets.



Refer to the following CF regulations and policies.



Points of interest or special instructions the instructor should pass along to the cadets.

Director Cadets 3, 2008, Ottawa, ON: Department of National Defence

Figure 9K-6 Note Boxes

The Conclusion

The conclusion section states any homework/reading/practice that may be required of the cadet and the method of evaluation as stated in the lesson specification. The conclusion section also provides a closing statement to be spoken aloud to the cadets and any additional instructor notes/remarks.

References

The reference section lists the references used to create the lesson specification and instructional guide. In some cases, an IG may direct the instructor to a specific reference to be used during a lesson. In most cases this section is only used to identify where the content of the lesson has been drawn from.

Annexes

The annex section contains information that may range from pre-made training aids, learning aids such as handouts and additional information for activities.

THIS PAGE INTENTIONALLY LEFT BLANK

LESSON PLAN

EO #:		Title of the EO:	
Instructor:		Location:	Total Time: min
TIME	REVIEW		NOTES
	EO#: ENABLING OBJECTIVE:		
TIME	INTRODUCTION		NOTES
	What: Where: Why:		
TIME	BODY		NOTES
	Teaching Method: TP 1:		
	TP 1 Confirmation:		

	Teaching Method: TP 2: TP 2 Confirmation:	
TIME	END OF LESSON CONFIRMATION	NOTES
TIME	CONCLUSION	NOTES
	Summary: In this lesson you have learned Re-Motivation: Your next lesson will be	

PLAN A LESSON CHECKLIST

PREPARATION	NOTES
<p>Have you:</p> <ul style="list-style-type: none"> <input type="checkbox"/> Selected an appropriate lesson location? <input type="checkbox"/> Selected an appropriate method of instruction? <input type="checkbox"/> Provided for a review of previous lesson materials? 	
INTRODUCTION	
<p>Does your introduction:</p> <ul style="list-style-type: none"> <input type="checkbox"/> State what the cadets will learn? <input type="checkbox"/> Describe why the information is important to learn? <input type="checkbox"/> Describe where and when the information / skill can be used? 	
BODY	
<p>Does the body of your lesson:</p> <ul style="list-style-type: none"> <input type="checkbox"/> Include the different principles of instruction? <input type="checkbox"/> Include questions? <input type="checkbox"/> Provide for the use of instructional aids? <input type="checkbox"/> Used explanation and demonstration? (skill lesson only) <input type="checkbox"/> Confirm each TP? 	
END OF LESSON CONFIRMATION	
<ul style="list-style-type: none"> <input type="checkbox"/> Did you conduct an end of lesson confirmation by using questions or by conducting an activity? 	
CONCLUSION	
<p>Does your conclusion:</p> <ul style="list-style-type: none"> <input type="checkbox"/> Summarize the lesson? <input type="checkbox"/> Re-motivate the cadets by: <ul style="list-style-type: none"> <input type="checkbox"/> commenting on their progress; and <input type="checkbox"/> re-stating why the information learned is important? <input type="checkbox"/> Describe the next lesson? 	

THIS PAGE INTENTIONALLY LEFT BLANK

LIST OF APPROVED 15-MINUTE TOPICS

TP 1 of M104.01 (Identify Activities That Will Help Achieve a Healthy Active Lifestyle, A-CR-CCP-701/PG-001, Chapter 4, Section 4, A-CR-CCP-701/PF-001, Chapter 4, Section 1),

TP 1 of M106.01 (Identify the Parts and the Characteristics of the Daisy 853c Air Rifle, A-CR-CCP-701/PG-001, Chapter 4, Section 6, A-CR-CCP-701/PF-001, Chapter 6, Section 1),

TP 4 of M106.03 (Apply Basic Marksmanship Techniques, A-CR-CCP-701/PG-001, Chapter 4, Section 6, A-CR-CCP-701/PF-001, Chapter 6, Section 3),

TP 1 of M203.01 (Discuss Leadership Within A Peer Setting, A-CR-CCP-702/PG-001, Chapter 4, Section 3, A-CR-CCP-702/PF-001, Chapter 3, Section 1).

Note: The TPs in this list were selected because they best fit into the 15-minute format. The selected EOs are a variety of knowledge and skill-based lessons.

THIS PAGE INTENTIONALLY LEFT BLANK

MODIFIED LESSON SPECIFICATIONS AND INSTRUCTIONAL GUIDES – TP 1 OF EO M104.01

A-CR-CCP-701/PG-001

EO M104.01 – IDENTIFY ACTIVITIES THAT WILL HELP ACHIEVE A HEALTHY ACTIVE LIFESTYLE

1. **Performance.** Identify Activities that Will Help Achieve a Healthy Active Lifestyle.
2. **Conditions**
 - a. Given:
 - (1) a copy of *Canada's Physical Activity Guide to Healthy Active Living*;
 - (2) supervision; and
 - (3) assistance as required.
 - b. Denied: *N/A*.
 - c. Environmental: Suitable classroom facilities/training area large enough to accommodate entire group.
3. **Standard.** In accordance with *Canada's Physical Activity Guide to Healthy Active Living*, the cadet shall identify activities that will help achieve a healthy and active lifestyle.

4. **Teaching Points**

TP	Description	Method	Time	Ref
TP1	Introduce cadets to <i>Canada's Physical Activity Guide to Healthy Active Living</i> , to include: <ol style="list-style-type: none"> a. page 4 – Check Out What You Are Doing Now; b. page 5 – Benefits of Physical Activity; c. page 6 – What Are You Into; d. page 8 – Let's Get Active; and e. page 10 – Crank Up Your Activity. 	Interactive Lecture	10 min	C0-020 (pp. 4 to 10)

5. **Time**
 - a. Introduction/Conclusion: 5 min
 - b. Interactive Lecture: 10 min
 - c. Total: 15 min
6. **Substantiation.** For TP1, the interactive lecture method was chosen as it allows the instructor to make a semi-formal presentation of the material where the cadets can participate by asking or responding to questions and commenting on the material. For this lesson, this method is most effective as it matches well the taxonomic level of the material and is age-appropriate by virtue of its participatory nature.
7. **References.** C0-020 (ISBN 0-662-32899) Minister of Health. (2002). *Canada's Physical Activity Guide to Healthy Active Living* [Brochure].
8. **Training Aids**
 - a. Presentation aids (i.e. whiteboard/flipchart/OHP) appropriate for classroom/training area; and
 - b. *Canada's Physical Activity Guide to Healthy Active Living*.

9. **Learning Aids.** *Canada's Physical Activity Guide to Healthy Active Living.*
10. **Test Details.** N/A.
11. **Remarks.** N/A.

A-CR-CCP-701/PF-001



COMMON TRAINING
SILVER STAR
INSTRUCTIONAL GUIDE



SECTION 1

EO M104.01 – IDENTIFY ACTIVITIES THAT WILL HELP ACHIEVE A HEALTHY ACTIVE LIFESTYLE

Total Time: 15 min

PREPARATION

PRE-LESSON INSTRUCTIONS

A complete list of resources needed for the instruction of this EO is located at Chapter 4 of the QSP. Specific uses for said stores are identified throughout the Instructional Guide, within the teaching point for which they are required.

The instructor shall review the lesson content and become familiar with the material prior to the instruction of the lesson.

PRE-LESSON ASSIGNMENT

N/A.

APPROACH

For TP1, the interactive lecture method was chosen as it allows the instructor to make a semi-formal presentation of the material where the cadets can participate by asking or responding to questions and commenting on the material. For this lesson, this method is most effective as it matches well the taxonomic level of the material and is age-appropriate by virtue of its participatory nature.

INTRODUCTION

REVIEW

N/A.

OBJECTIVES

By the end of this lesson the cadet shall be expected to identify activities that will help them achieve a healthy and active lifestyle.

IMPORTANCE

Physical fitness is one of the three aims of the cadet program. Teaching the cadets what activities contribute to an active lifestyle will help them achieve physical fitness.

A-CR-CCP-701/PF-001

Teaching Point 1

Introduce Cadets to *Canada's Physical Activity Guide to Healthy Active Living*

Time: 10 min

Method: Interactive Lecture

CANADA'S PHYSICAL ACTIVITY GUIDE TO HEALTHY ACTIVE LIVING

Hand out *Canada's Physical Activity Guide to Healthy Active Living*, highlighting the following pages and information detailed there:

- **Page 4 – Check Out What You Are Doing Now.** Is your exercise time more than 90 minutes per day? Less than 90 minutes but more than 60? Less than 60 but more than 30? Have each cadet write down their activities from yesterday and two days ago to add up their total time.
- **Page 5 – Benefits of Physical Activity.** Meet new friends, improve physical self-esteem, achieve a healthy weight, build strong bones and strengthen muscles, maintain flexibility, promote good posture and balance, improve fitness, strengthen the heart, increase relaxation and promote healthy growth and development.
- **Page 6 – What Are You Into.** Walking, running, hiking, cycling, swimming, jogging, gymnastics, ice-skating, skiing, basketball, volleyball, tobogganing, soccer, football, tennis, baseball, softball, dancing, yoga, climbing, bowling, hockey, skateboarding, badminton, etc. Have the cadets brainstorm all the activities they can think of that they may be interested in.
- **Page 8 – Let's Get Active.** Increase the time currently spent on physical activity and reduce non-active time.
- **Page 10 – Crank Up Your Activity.** Walking instead of taking the bus, playing ball at breaks, walking the dog, raking leaves, shovelling snow, carrying groceries, etc. Brainstorm ideas that will help increase current physical activity.

The purpose of highlighting these pages is to fuel the discussion for the next teaching point. The cadets may take home the guides and explore them further afterwards.

END OF LESSON CONFIRMATION

The confirmation of this lesson will occur in EO M104.02 (Section 2) as the cadets develop a personal activity plan.

CONCLUSION

HOMEWORK/READING/PRACTICE

N/A.

METHOD OF EVALUATION

There is no formal assessment of this EO.

CLOSING STATEMENT

As physical fitness is one of the aims of the cadet program, it is important that cadets learn what activities contribute to an active lifestyle to help them achieve physical fitness.

A-CR-CCP-701/PF-001

INSTRUCTOR NOTES/REMARKS

N/A.

REFERENCES

- C1-011 (ISBN 0-662-32899) Minister of Health (2002). *Canada's Physical Activity Guide to Healthy Active Living* [Brochure].
- C3-024 (ISBN 0-7627-0476-4) Roberts, H. (1989). *Basic Essentials Backpacking*. Guildford, CT: The Globe Pequot Press.

THIS PAGE INTENTIONALLY LEFT BLANK

MODIFIED LESSON SPECIFICATIONS AND INSTRUCTIONAL GUIDES – TP 1 OF EO M106.01

A-CR-CCP-701/PG-001

EO M106.01 – IDENTIFY THE PARTS AND CHARACTERISTICS OF THE DAISY 853C AIR RIFLE

1. **Performance.** Identify the Parts and Characteristics of the Daisy 853C Air Rifle.
2. **Conditions**
 - a. Given:
 - (1) Daisy 853C air rifle;
 - (2) assistance as required; and
 - (3) supervision.
 - b. Denied: N/A.
 - c. Environmental: Suitable classroom facility and/or air rifle range constructed IAW A-CR-CCP-177/PT-001, Chapter 1, sect 8.
3. **Standard.** In accordance with A-CR-CCP-177/PT-001, the cadet shall identify the parts and list the characteristics of the Daisy 853C air rifle.
4. **Teaching Points**

TP	Description	Method	Time	Ref
TP1	Identify the parts of the Daisy 853C air rifle, to include: <ol style="list-style-type: none"> a. butt plate; b. spacers; c. small of the butt; d. stock; e. fore end; f. sling bracket; g. trigger; h. trigger guard; i. safety catch; j. bolt; k. pump handle; l. front sight; m. rear sight; n. muzzle; o. barrel with barrel weight; p. bore; q. feed track; r. chamber; s. sling; t. single shot adapter; and 	Interactive Lecture	10 min	A0-027 (p. 2-5, Diagram)

TP	Description	Method	Time	Ref
	u. five-shot clip. Note: The instructor shall ensure that the cadet can identify the parts of the cadet air rifle by physically pointing to the proper part on the rifle or on an unlabeled diagram.			

5. **Time**
 - a. Introduction/Conclusion: 5 min
 - b. Interactive Lecture: 10 min
 - c. Total: 15 min
6. **Substantiation.** The interactive lecture method was chosen as it best allows the instructor to make a semi-formal presentation of the material allowing the cadets to participate by asking or responding to questions, commenting on the material, or participating in short activities. This method appeals to auditory learners, with the potential for active participation in activities that appeal to tactile/kinaesthetic learners.
7. **References.** A0-027 A-CR-CCP-177/PT-001 D Cdts 3. (2001). *Canadian Cadet Movement: Cadet Marksmanship Programme Reference Manual*. Ottawa, ON: Department of National Defence.
8. **Training Aids**
 - a. Daisy 853C air rifle; and
 - b. Presentation aids (i.e. whiteboard/flipchart/OHP) appropriate for classroom/training area.
9. **Learning Aids.** Daisy 853C air rifle.
10. **Test Details.** Assessment of this EO shall be carried out during the end of lesson check. While there is no formal assessment of this EO, every cadet is required to successfully complete the Cadet Air Rifle Handling Test provided at Chapter 3, Annex C.
11. **Remarks.** N/A.

A-CR-CCP-701/PF-001



COMMON TRAINING
SILVER STAR
INSTRUCTIONAL GUIDE



SECTION 1

EO M106.01 – IDENTIFY THE PARTS AND THE CHARACTERISTICS OF THE DAISY 853C AIR RIFLE

Total Time: 15 min

PREPARATION

PRE-LESSON INSTRUCTIONS

A complete list of resources needed for the instruction of this EO is located at Chapter 4 of the QSP. Specific uses for said stores are identified throughout the Instructional Guide, within the teaching point for which they are required.

Prior to instructing this lesson the instructor shall:

- review the lesson content, and become familiar with the material;
- carry out a safety precaution check on all rifles to be used during this lesson; and
- state to cadets that the rifles have been inspected and are safe to handle.

PRE-LESSON ASSIGNMENT

N/A.

APPROACH

This lesson will be presented using the interactive lecture method. The interactive lecture method was chosen as it best allows the instructor to make a semi-formal presentation of the material allowing the cadets to participate by asking or responding to questions, commenting on the material, or participating in short activities. This method appeals to auditory learners, with the potential for active participation in activities that appeal to tactile/ kinaesthetic learners.

INTRODUCTION

REVIEW

N/A.

OBJECTIVES

By the end of this lesson the cadet shall be expected to identify the parts, and list the characteristics of the cadet air rifle.

A-CR-CCP-701/PF-001

IMPORTANCE

Cadets must have a basic knowledge of the cadet air rifle in order to understand how the rifle works and to safely follow directions given on the range.

Teaching Point 1

Identify the Parts of the Daisy 853C Air Rifle

Time: 10 min

Method: Interactive Lecture

PARTS



- Depending on the number of rifles available, distribute them with an optimum ratio of one rifle for every two cadets.
- When possible, have a second instructor in the room to assist.
- **For safety purposes, maintain strict class control at all times.**

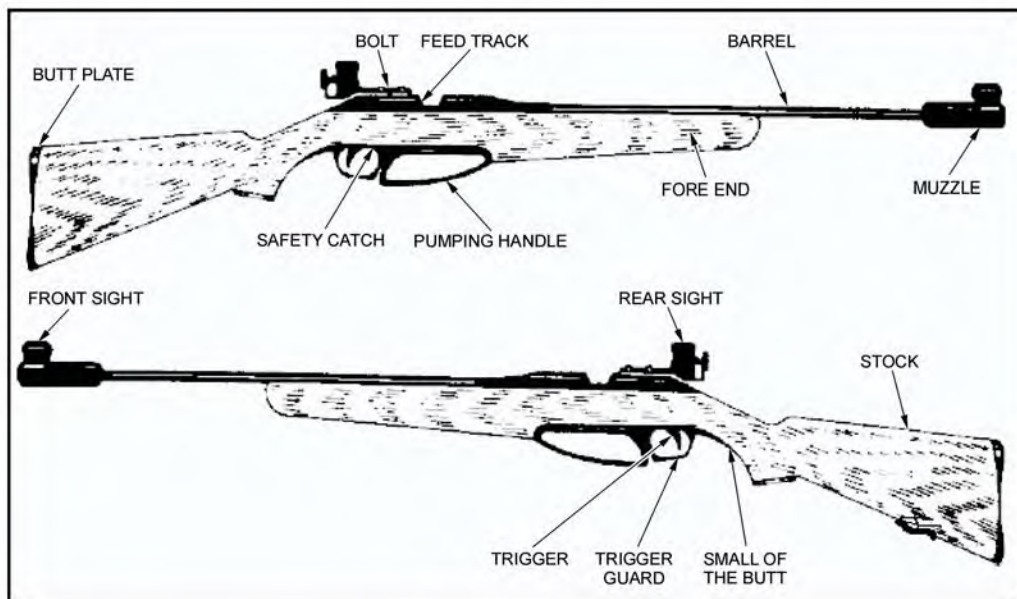

A-CR-CCP-177/PT-001

Figure 6-1-1 Parts of the Cadet Air Rifle

Butt Plate (End of the Butt). It is the part of the rifle directly in contact with the marksman's shoulder. When fitted properly, the butt plate aids in achieving a snug fit, and a consistent placement of the rifle into the shoulder. The addition of butt spacers allows for this adjustment in length.

Spacers. Plastic inserts that can be added or removed from the butt plate to vary its length. To add or take away butt spacers, use a Phillips screwdriver to loosen the butt plate and slide in/out the amount of spacers desired.

A-CR-CCP-701/PF-001

Small of the Butt (Pistol Grip). Curved area directly behind the trigger guard where the hand controlling the trigger grips the rifle.

Stock. Complete wooden portion of the rifle (from the butt plate end forward).

Fore End (of the Stock). Wooden portion of the stock from the trigger guard forward, in which the barrel and the rifle mechanism are encased.

Sling. It is a web sling made of nylon. Links the rifle to the marksman's arm to support most of the weight of the rifle. One end attaches to the sling bracket and the other to the upper arm.

Sling Bracket (Hand Stop). Adjustable metal clasp attached to the fore stock used to affix the sling to the rifle. It also acts as a hand stop, used to rest the left hand to prevent it from moving.

Trigger. Movable device that releases a spring and releases the rifle mechanism. This rifle has a single stage trigger that cannot be adjusted for weight.

Trigger Guard. Metal band that surrounds and protects the trigger.

Safety Catch. This is a mechanism that, once engaged, prevents the rifle from firing by locking the trigger in place. It is a cross bolt type device located on the trigger guard. The black side indicates that the rifle is unable to fire; the red side indicates the rifle is ready to fire. It should be ON (no red) at all times, unless firing.

Bolt. Metal lever used for opening or closing the rifle mechanism. It must be in the closed position in order to fire. For maximum safety when the rifle is uncased and not firing, the bolt should be kept open.

Pump Handle. Metal lever used to compress the air required to fire the pellet. Whenever the rifle is in a "safe rifle status", the pump lever should be left partially open.

Front Sight. Global front sight that uses aperture inserts.

Rear Sight. Micrometer sight adjustable for windage and elevation. It is easily attached to a metal rail located above the action. This rail allows for adjustment of the sight forward or backward, in order to maintain proper eye relief. The sight is attached using a small flat-blade screwdriver.

Muzzle. Front end of the barrel equipped with attachable barrel weight.

Barrel With Barrel Weight. Steel tube through which the pellet travels, extending from the muzzle to the chamber. The barrel weight ensures that the rifle's weight is evenly distributed and that the rifle's balance is maintained.

Bore. Interior of the barrel has spiral grooves cut into it. The lands are the ridges of metal between the grooves. Together, the grooves and lands are called rifling.

Feed Track. Delicate area where the pellet is inserted manually onto a single pellet adapter, or with a five-shot clip.

Single Shot Adapter. Plastic clip that aids in placing a pellet in the chamber.

Five-shot Clip. Plastic clip that holds a maximum of five pellets and used to place the pellets in the chamber.

Chamber. Location where the pellet is held before firing.

CONFIRMATION OF TEACHING POINT 1

The instructor shall ensure that the cadet can identify the parts of the cadet air rifle by physically pointing to the parts, and having the cadets properly name the part.

A-CR-CCP-701/PF-001

END OF LESSON CONFIRMATION

This EO may be confirmed with the handout found at Annex A. Allow cadets a few minutes to complete the annex, then have cadets switch sheets for correcting.



Correctly labelled diagram is located at page 6A-2.

CONCLUSION

HOMEWORK/READING/PRACTICE

Cadets are to take home the corrected handout to study the parts of the cadet air rifle.

METHOD OF EVALUATION

The instructor will confirm cadets' ability to identify the parts and characteristics of the cadet air rifle by asking questions during the end of lesson confirmation, and with the handout found at Annex A.

CLOSING STATEMENT

Knowing the parts and characteristics of the cadet air rifle is important in understanding how the rifle works. This allows the cadet to be able to follow directions given on the range, and properly perform a handling test whenever an air rifle is to be used.

INSTRUCTOR NOTES/REMARKS

Emphasis must be placed on the safety aspect of this lesson.

REFERENCES

A0-027 A-CR-CCP-177/PT-001 D Cdts 3. (2001). *Canadian Cadet Movement: Cadet Marksmanship Programme Reference Manual*. Ottawa, ON: Department of National Defence.

PARTS AND CHARACTERISTICS OF THE CADET AIR RIFLE

EO M106.01 Identify the Parts and Characteristics of the Cadet Air Rifle.

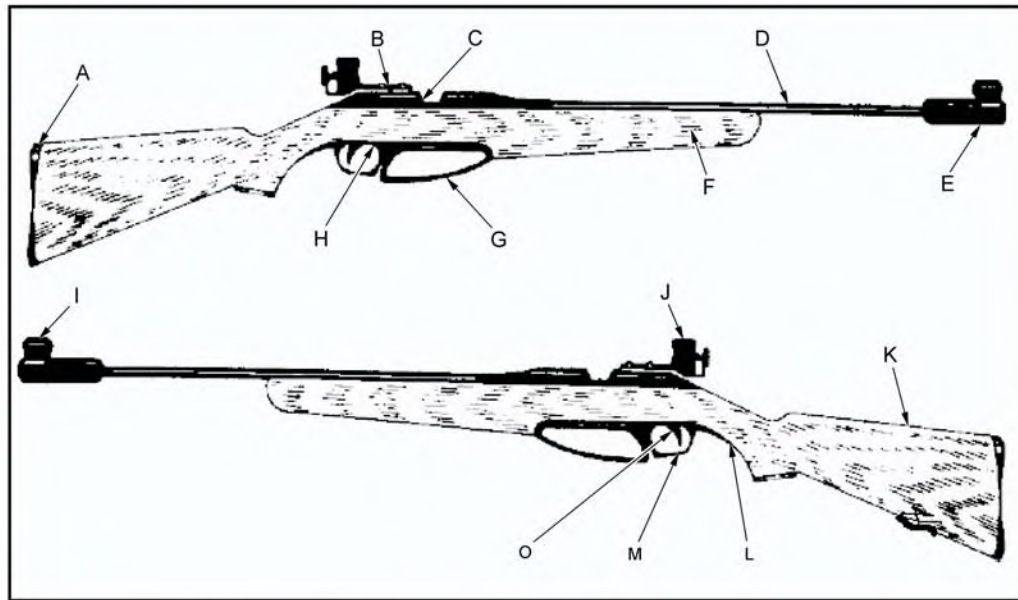

Put the letter next to the matching name of the part of the cadet air rifle.

- | | | | |
|----------------------|-------|-------------------|-------|
| 1. Feed Track | _____ | 8. Safety Catch | _____ |
| 2. Small of the Butt | _____ | 9. Muzzle | _____ |
| 3. Barrel | _____ | 10. Pump Lever | _____ |
| 4. Fore End | _____ | 11. Front Sight | _____ |
| 5. Rear Sight | _____ | 12. Trigger Guard | _____ |
| 6. Trigger | _____ | 13. Butt Plate | _____ |
| 7. Bolt | _____ | 14. Stock | _____ |

A-CR-CCP-701/PF-001
 Chapter 6, Annex A

ANSWER KEY

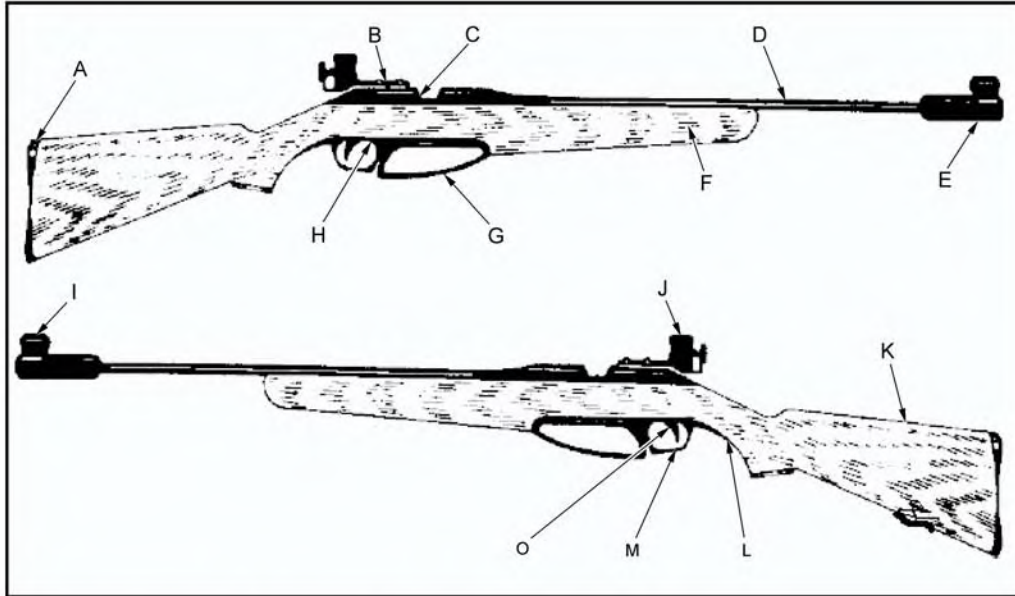

Put the letter next to the matching name of the part of the cadet air rifle.

- | | | | |
|----------------------|------------------------------|-------------------|------------------------------|
| 1. Feed Track | <u> C </u> | 8. Safety Catch | <u> H </u> |
| 2. Small of the Butt | <u> L </u> | 9. Muzzle | <u> E </u> |
| 3. Barrel | <u> D </u> | 10. Pump Lever | <u> G </u> |
| 4. Fore End | <u> F </u> | 11. Front Sight | <u> I </u> |
| 5. Rear Sight | <u> J </u> | 12. Trigger Guard | <u> M </u> |
| 6. Trigger | <u> O </u> | 13. Butt Plate | <u> A </u> |
| 7. Bolt | <u> B </u> | 14. Stock | <u> K </u> |

MODIFIED LESSON SPECIFICATIONS AND INSTRUCTIONAL GUIDES – TP 4 OF EO M106.03

A-CR-CCP-701/PG-001

EO M106.03 – APPLY BASIC MARKSMANSHIP TECHNIQUES

1. **Performance.** Apply Basic Marksmanship Techniques.
2. **Conditions**
 - a. Given:
 - (1) cadet air rifle;
 - (2) single pellet adaptor
 - (3) assistance as required; and
 - (4) supervision.
 - b. Denied: N/A.
 - c. Environmental: Suitable classroom facility and/or air rifle range constructed IAW A-CR-CCP-177/PT-001, Chapter 1, sect 8.
3. **Standard.** In accordance with A-CR-CCP-177/PT-001, the cadet shall apply basic marksmanship techniques, to include:
 - a. loading;
 - b. unloading; and
 - c. preparing for inspection.
4. **Teaching Points**

TP	Description	Method	Time	Ref
TP4	Explain, demonstrate, and have the cadets load, unload, and prepare for inspection the cadet air rifle, as follows: <ol style="list-style-type: none"> a. loading the cadet air rifle, to include: <ol style="list-style-type: none"> (1) picking up the rifle with the left hand; (2) ensuring safety catch is in the ON position; (3) pumping the air rifle, pausing for three seconds; (4) bringing pump handle back to closed position; (5) loading a pellet; and b. unloading the cadet air rifle, to include: <ol style="list-style-type: none"> (1) opening the bolt (do not insert a pellet); (2) pumping the air rifle, pausing for three seconds; (3) closing the bolt (do not insert a pellet); 	Demonstration and Performance	10 min	A0-027 (p. 2-16)

TP	Description	Method	Time	Ref
	(4) placing the safety catch in the OFF position; (5) aiming the rifle at the target; (6) squeezing the trigger; (7) placing the safety catch in the ON position; and c. preparing for inspection, to include: (1) opening the bolt; (2) opening the pump handle slightly; (3) placing the rifle on the shoulder, muzzle pointed down range; (4) waiting to be cleared by the RSO; and (5) laying the rifle down. Note: Cadets will be required to perform these skills during their air rifle handling test. The pellet guide shall be used for training, although cadets may be introduced to the five-round clip prior to actual firing.			

5. **Time**

- a. Introduction/Conclusion: 5 min
- b. Demonstration and Performance: 10 min
- c. Total: 15 min

6. **Substantiation.** The demonstration-performance method was chosen to allow cadets to participate in supervised exploration of practical instructional material. This method provides the instructor the opportunity to introduce the subject matter, demonstrate and explain procedures, and supervise the cadets while they imitate the skill. This method appeals to all learning styles.

7. **References.** A0-027 A-CR-CCP-177/PT-001 D Cdts 3. (2001). *Canadian Cadet Movement: Cadet Marksmanship Programme Reference Manual*. Ottawa, ON: Department of National Defence.

8. **Training Aids**

- a. Presentation aids (i.e. whiteboard/flipchart/OHP) appropriate for classroom/training area; and
- b. Cadet air rifle.

9. **Learning Aids.** Cadet air rifle.

10. **Test Details.** N/A.

11. **Remarks.** N/A.



COMMON TRAINING
SILVER STAR
INSTRUCTIONAL GUIDE



SECTION 3

EO M106.03 – APPLY BASIC MARKSMANSHIP TECHNIQUES

Total Time: 15 min

PREPARATION

PRE-LESSON INSTRUCTIONS

Resources needed for the delivery of this lesson are listed in the lesson specification located at Chapter 4 of the QSP. Specific uses for said resources are identified throughout the Instructional Guide, within the teaching point for which they are required.

Review the lesson content, and become familiar with the material prior to delivering the lesson.

PRE-LESSON ASSIGNMENT

N/A.

APPROACH

This lesson will be presented using the demonstration and performance method. The demonstration and performance method was chosen to allow cadets to participate in supervised exploration of practical instructional material. This method provides the instructor the opportunity to introduce the subject matter, demonstrate and explain procedures, and supervise the cadets while they imitate the skill. This method appeals to all learning styles.



This lesson may be better presented using a round robin format for those units with large first year groups.

INTRODUCTION

REVIEW

The pertinent review for this lesson, from EO M106.02 (Section 2), will include:

QUESTIONS

- Q1. Why are the individual safety precautions performed?
- Q2. What is the purpose of the "safety catch"?

A-CR-CCP-701/PF-001

ANTICIPATED ANSWERS

- A1. To confirm a rifle is safe.
A2. It prevents a rifle from firing by locking its trigger into place.

OBJECTIVES

By the end of this lesson the cadet shall be expected to apply basic marksmanship techniques to include:

- prone position;
- basic holding;
- basic aiming;
- loading;
- firing; and
- unloading.

Cadets will apply the knowledge gained during this lesson when they participate in any range practice.

IMPORTANCE

These techniques must all be applied in harmony. Improving one while not working on another will not produce the best results in the long run. Perfecting these techniques takes time and concentration. Cadets should remember – PRACTICE MAKES PERFECT!

Teaching Point 4

Explain and Demonstrate How To Load and Unload the Cadet Air Rifle

Time: 10 min

Method: Demonstration and Performance

LOADING THE AIR RIFLE



The instructor shall provide an EXPLANATION and DEMONSTRATION of the complete skill.

The instructor shall also provide an EXPLANATION and DEMONSTRATION of each step required to effectively complete the skill.

This will be conducted as a DRY FIRE EXERCISE ONLY.

Loading procedure:

1. Pick up the rifle with the left hand.
2. Ensure the safety catch is in the ON position.
3. Pump the air rifle, pausing for 3 seconds.
4. Bring the pump handle back to closed position.
5. Simulate loading a pellet, or load an auto indexing five-pellet clip into the feed track.

A-CR-CCP-701/PF-001

6. Close the bolt.



Cadets will IMITATE the demonstration provided by the instructor for each step within the skill. The instructor(s) will SUPERVISE the cadets during this imitation.



The following methods may be used when pumping the air rifle:

- **Option 1.** Grasp the pistol grip with the right hand. Grasp the pump handle with the left hand. Push downward with the left hand until the pump handle is fully extended. Wait for a few seconds. Using the left hand, bring the pump handle back to the stock of the rifle. The rifle should remain stationary during the pumping process and always point towards the targets.
- **Option 2.** Grasp the pistol grip with the right hand. Grasp the pump handle with the left hand. Place the butt of the rifle under the right arm or shoulder for support. Push downward with the left hand until the pump handle is fully extended. Wait for a few seconds. Using the left hand, bring the pump handle back to the stock of the rifle allowing the underarm and shoulder to help hold the rifle steady when closing the pump handle. Remember that the rifle must always point towards the targets.
- **Option 3 – Coach Assistance.** Point the rifle in a safe direction and request the assistance from a coach. The coach should move in and pump the rifle using both hands. This should be used as last resorts as any cadet can easily do the above two options.

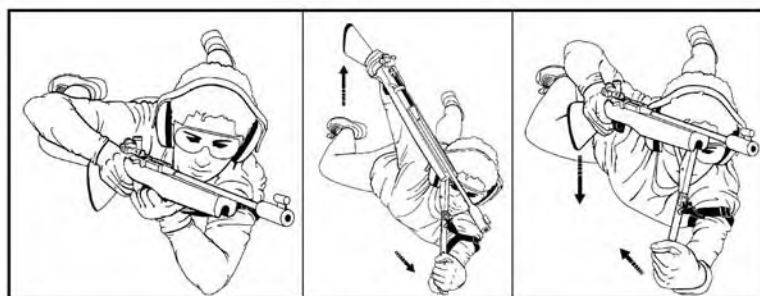

Cadet Marksmanship Program Reference Manual

Figure 6-3-7 Pumping the Air Rifle



Do not pump the rifle more than once per shot. This air rifle is designed to withstand the pressure based on a single pump stroke.



The instructor shall provide an EXPLANATION and DEMONSTRATION of the complete skill.

The instructor shall also provide an EXPLANATION and DEMONSTRATION of each step required to effectively complete the skill.

A-CR-CCP-701/PF-001

UNLOADING THE CADET AIR RIFLE

Follow the unloading sequence of the cadet air rifle, to include:

UNLOAD

1. Pick up the air rifle.
2. Remove five-pellet clip (if used).
3. Open the bolt (do not insert a pellet).
4. Pump the air rifle, pausing for 3 seconds.
5. Close the bolt (do not insert a pellet).
6. Place the safety catch in the OFF position.
7. Aim the rifle at the target.
8. Squeeze the trigger.
9. Place the safety catch in the ON position.

PREPARE FOR INSPECTION

1. Open the bolt.
2. Open the pump handle slightly.
3. Place the rifle on shoulder, muzzle pointed down range.
4. Wait to be cleared by the RSO.
5. Lay the rifle down.



Cadets will IMITATE the demonstration provided by the instructor for each step within the skill. The instructor(s) will SUPERVISE the cadets during this imitation.

CONFIRMATION OF TEACHING POINT 4



The instructor will divide the group into two, or by the number of air rifles available. The instructor shall have one group imitate the actions of the sequence as demonstrated, while the remainder observe. Have them trade places, and repeat.

END OF LESSON CONFIRMATION

The instructor will divide the group into two, or by the number of air rifles available. The instructor shall have one group imitate the actions of the sequence for all teaching points as demonstrated, while the remainder observe, and then have them trade places, and repeat.

A-CR-CCP-701/PF-001

CONCLUSION

HOMEWORK/READING/PRACTICE

N/A.

METHOD OF EVALUATION

N/A.

CLOSING STATEMENT

The first principle of marksmanship is to find a comfortable shooting position. A comfortable shooting position will enable cadets to shoot safely and with much better results. The prone position is the most stable shooting position to use.

INSTRUCTOR NOTES/REMARKS

1. Emphasis must be placed on the safety aspects of this lesson.
2. Ensure thorough confirmation by stages.

REFERENCES

A0-027 A-CR-CCP-177/PT-001 D Cdts 3. (2001). *Canadian Cadet Movement: Cadet Marksmanship Programme Reference Manual*. Ottawa, ON: Department of National Defence.

THIS PAGE INTENTIONALLY LEFT BLANK

MODIFIED LESSON SPECIFICATIONS AND INSTRUCTIONAL GUIDES – TP 1 OF EO M203.01

A-CR-CCP-702/PG-001

EO M203.01 – DISCUSS LEADERSHIP WITHIN A PEER SETTING

1. **Performance.** Discuss Leadership Within a Peer Setting.
2. **Conditions**
 - a. Given:
 - (1) supervision; and
 - (2) assistance as required.
 - b. Denied: N/A.
 - c. Environmental: Suitable classroom facilities or training area large enough to accommodate the entire group.
3. **Standard.** The cadet shall discuss leadership within a peer setting.

4. **Teaching Points**

TP	Description	Method	Time	Ref
TP1	Explain leadership within a peer setting, to include: <ol style="list-style-type: none"> a. responsibilities of a Silver Star cadet, to include: <ol style="list-style-type: none"> (1) following the chain of command; (2) setting the example; (3) being firm, fair and friendly; (4) being respectful to superiors and subordinates; (5) being aware of safety hazards; (6) displaying initiative; and (7) setting goals; and b. corps specific Silver Star cadet responsibilities. 	Interactive Lecture	10 min	C0-134

5. **Time**
 - a. Introduction/Conclusion: 5 min
 - b. Interactive Lecture: 10 min
 - c. Total: 15 min
6. **Substantiation.** An interactive lecture was chosen for TP1 to orient the cadets to junior leadership, to generate interest and present basic material.
7. **References.** C0-134 (ISBN 0-7852-7440-5) Maxwell, J. (1999). *The 21 Indispensable Qualities of a Leader: Becoming the Person Others Will Want to Follow*. Nashville, TN: Thomas Nelson Publishers.
8. **Training Aids.** Presentation aids (eg, whiteboard/flipchart/OHP) appropriate for the classroom/training area.
9. **Learning Aids.** N/A.

10. **Test Details.** N/A.
11. **Remarks.** The list of responsibilities in TP1 is not exhaustive. For each corps Silver Star cadet responsibilities may vary.

A-CR-CCP-702/PF-001



**COMMON TRAINING
SILVER STAR
INSTRUCTIONAL GUIDE**



SECTION 1

EO M203.01 – DISCUSS LEADERSHIP WITHIN A PEER SETTING

Total Time: 15 min

PREPARATION

PRE-LESSON INSTRUCTIONS

Resources needed for the delivery of this lesson are listed in the lesson specification located in A-CR-CCP-702/PG-001, Chapter 4. Specific uses for said resources are identified throughout the Instructional Guide within the TP for which they are required.

Review the lesson content and become familiar with the material prior to delivering the lesson.

The list of responsibilities of Silver Star cadets will vary for each corps. Information about the specific responsibilities should be available in the corps Standing Orders or by speaking to the corps Commanding Officer/Training Officer.

PRE-LESSON ASSIGNMENT

N/A.

APPROACH

An interactive lecture was chosen for TP1 to orient the cadets to leadership within a peer setting, to generate interest and to present basic material.

INTRODUCTION

REVIEW

N/A.

OBJECTIVES

By the end of this lesson the cadet shall be expected to discuss leadership within a peer setting.

IMPORTANCE

It is important for cadets to learn about leadership within a peer setting because there are responsibilities for second year cadets. Being aware of the responsibilities second year cadets perform will assist them in setting achievable goals and adapting to their new role as leaders in the corps.

A-CR-CCP-702/PF-001

Teaching Point 1

Explain Leadership Within a Peer Setting

Time: 10 min

Method: Interactive Lecture

Within junior leadership, there are responsibilities for a Silver Star cadet at the corps. To make the second year of cadets a fun, challenging and dynamic experience, second year cadets should know their responsibilities.



Have cadets brainstorm a list of what they think the responsibilities of a Silver Star cadet are. As you teach each of the following points, try to match them to the cadet generated list.

There are some responsibilities common to every Red Star cadet in the corps. They are:

- **Following the Chain of Command.** Following the chain of command ensures that all information that must be passed up and down the chain is delivered. Following the chain of command prevents gaps in the information flow.
- **Setting the Example.** A Silver Star cadet must set a personal example in dress and deportment. A good leader will never ask more of their followers and teammates than they are willing to give themselves.
- **Being Firm, Fair and Friendly with Everyone, Especially New Recruits.** No one is impressed with a Silver Star cadet who yells, least of all new cadets. A highly influential and respected Silver Star cadet is one who is consistent in their approach to people and each situation. Being approachable at all times should enable the cadet to fulfill all duties and responsibilities in an effective manner.
- **Being Respectful to Superiors and Subordinates.** Using a proper tone of voice, looking people in the eyes when they speak and standing up straight is a physical way to show respect. If the Silver Star cadet wishes to be treated with respect, they must display respect toward others.
- **Being Aware of Safety Hazards.**
- **Displaying Initiative.** Undertaking small matters, like cleaning up, before being told to do so is an example of using initiative. Superiors notice when small tasks are completed without any request to do so.
- **Setting Goals.** Every leader needs to set goals. Goals allow people the opportunity to turn ideas into results. A goal is a glimpse of the future. Setting goals like improving their drill, dress and deportment, gives Silver Star cadets something to strive for. By setting goals, and working towards them, a Red Star cadet will show commitment.



If the corps has no specific duties for Silver Star cadets, do not teach the following point.

There are specific responsibilities of a Silver Star cadet in this corps.



Explain the corps specific Silver Star cadet responsibilities.

A-CR-CCP-702/PF-001

CONFIRMATION OF TEACHING POINT 1

QUESTIONS

- Q1. List the responsibilities of Silver Star cadets in the corps.
- Q2. Why is setting goals important for a Silver Star cadet?
- Q3. List the specific Silver Star cadet duties and responsibilities for your corps.

ANTICIPATED ANSWERS

- A1. The responsibilities of every Silver Star cadet in the corps are:
- following the chain of command;
 - setting the example;
 - being firm, fair and friendly with everyone, especially new recruits;
 - being respectful towards your superiors and subordinates;
 - being aware of safety hazards;
 - displaying initiative; and
 - setting goals.
- A2. By setting goals and working towards them, the Silver Star cadet will show commitment.
- A3. Answers will vary.

END OF LESSON CONFIRMATION

The cadets' participation in TP1 will serve as the confirmation of this lesson.

CONCLUSION

HOMEWORK/READING/PRACTICE

N/A.

METHOD OF EVALUATION

N/A.

CLOSING STATEMENT

In order for a cadet to be successful in the role of a Silver Star, they must know their responsibilities. By setting personal short and long term goals, cadets have something to work toward and may be more motivated to complete the tasks ahead.

INSTRUCTOR NOTES/REMARKS

N/A.

A-CR-CCP-702/PF-001

REFERENCES

C0-134 (ISBN 0-7852-7440-5) Maxwell, J. (1999). *The 21 Indispensable Qualities of a Leader: Becoming the Person Others Will Want to Follow*. Nashville, TN: Thomas Nelson Publishers.

MODIFIED LESSON SPECIFICATIONS AND INSTRUCTIONAL GUIDES – TP 1 OF EO M107.02

A-CR-CCP-701/PG-001

EO M107.02 – IDENTIFY ARMY CADET RANKS AND OFFICER RANKS

1. **Performance.** Identify Army Cadet Ranks and Officer Ranks.
2. **Conditions**
 - a. Given:
 - (1) supervision; and
 - (2) assistance as required.
 - b. Denied: N/A.
 - c. Environmental: Suitable classroom facilities or training area large enough to accommodate the entire group.
3. **Standard.** In accordance with specified references, the cadet shall identify the rank structure of the Royal Canadian Army Cadets (RCAC).

4. **Teaching Points**

TP	Description	Method	Time	Ref
TP1	<p>Explain, and confirm through an educational game, the structure and rank insignia of the RCAC, to include:</p> <ol style="list-style-type: none"> a. Private (Pte); b. Corporal (Cpl); c. Master Corporal (MCpl); d. Sergeant (Sgt); e. Warrant Officer (WO); f. Master Warrant Officer (MWO); and g. Chief Warrant Officer (CWO). <p>Note: Explain to cadets that the rank insignia of the Army Cadets is the same as the NCM rank insignia of the army element of the CF.</p>	Interactive Lecture	10 min	A2-030 (pp. 2/5 to 4/5)

5. **Time**
 - a. Introduction/Conclusion: 5 min
 - b. Interactive Lecture: 10 min
 - c. Total: 15 min
6. **Substantiation.** The interactive lecture method was chosen as it best allows the instructor to make a semi-formal presentation of the material allowing the cadets to participate by asking or responding to questions, commenting on the material, or participating in short activities. This method appeals to auditory learners, with the potential for active participation in activities that appeal to tactile/kinaesthetic learners.

A-CR-CCP-701/PG-001

7. **References**

- a. A0-001 A-AD-265-000/AG-001 DHH 3-2. (2001). *Canadian Forces Dress Instructions*. Ottawa, ON: The Department of National Defence.
- b. A0-009 A-AA-100-000/AA-003 Canadian Forces. (2006). *QR&O Chapter 3, Section 1 Ranks and Designations of Ranks*. Ottawa, ON: The Department of National Defence.
- c. A2-030 D Cdts. (2005). CATO 40-03, *Army Cadet Ranks and Cadet Corps Establishment*. In *Cadet Administrative and Training Orders* (Vol. 4, 5 pages). Ottawa, ON.

8. **Training Aids**

- a. Presentation aids (i.e. whiteboard/flipchart/OHP) appropriate for classroom/training area; and
- b. Royal Canadian Army Cadet Symbols poster.

9. **Learning Aids.** Royal Canadian Army Cadet Symbols poster.

10. **Test Details.** There is no formal assessment of this EO. Instructors will confirm the cadets' knowledge of ranks during the end of lesson check.

11. **Remarks.** Where practical, instructors are encouraged to have the actual rank badges on hand so that the cadets can pass them around. Where not practical, a cut out of the badge could be used.

A-CR-CCP-701/PF-001



ROYAL CANADIAN ARMY CADETS

GREEN STAR

INSTRUCTIONAL GUIDE



SECTION 2

EO M107.02 – IDENTIFY ARMY CADET RANKS AND OFFICER RANKS

Total Time: 15 min

PREPARATION

PRE-LESSON INSTRUCTIONS

Resources needed for the delivery of this lesson are listed in the lesson specification located at Chapter 4 of the QSP. Specific uses for said resources are identified throughout the Instructional Guide, within the teaching point for which they are required.

Review the lesson content, and become familiar with the material prior to instruction of this lesson.

PRE-LESSON ASSIGNMENT

N/A.

APPROACH

This lesson will be presented using the interactive lecture method. The interactive lecture method was chosen as it best allows the instructor to make a semi-formal presentation of the material allowing the cadets to participate by asking or responding to questions, commenting on the material, or participating in short activities. This method appeals to auditory learners, with the potential for active participation in activities that appeal to tactile/ kinaesthetic learners.

INTRODUCTION

REVIEW

N/A.

OBJECTIVES

By the end of this lesson the cadet shall be expected to correctly identify the rank structure of the Royal Canadian Army Cadets (RCAC), as well as the ranks of Canadian Forces (CF) Army officers.

IMPORTANCE

Being familiar with the ranks of the Army Cadets and officers of the CF will help cadets understand the relationship between cadet ranks and officers at the corps. It will also aid them in interacting effectively with CF members when visiting other CF facilities or bases.

A-CR-CCP-701/PF-001

Teaching Point 1

Explain the Structure and Rank Insignia of the RCAC

Time: 10 min

Method: Interactive Lecture



It is interesting to note that Army Cadets have the same rank titles and insignia as Non-Commissioned Members (NCMs) in the Canadian Army. Once Army Cadets understand the structure of their own NCMs, they will be able to properly identify those in the Army NCM structure.

CADET RANKS NON-COMMISSIONED MEMBERS (NCMS)

Rank is a system of grading seniority and command within military organizations. The gold arrows are referred to as "chevrons". The more chevrons used, the higher the seniority of the individual.

These chevrons are worn on the upper arm, on the right sleeve of the cadet tunic.



Figure 7-2-1 Non-commissioned Members: Pte – Cpl – MCpl – Sgt

The "Tudor" crown represents the rank of Warrant Officer (WO).

The "Tudor" crown surrounded by a laurel wreath represents the rank of Master Warrant Officer (MWO).

The Canadian Coat of Arms represents the rank of Chief Warrant Officer (CWO).

These ranks are worn low on the sleeve of the right arm of the cadet tunic.



Figure 7-2-2 Non-commissioned Members: WO – MWO – CWO

A-CR-CCP-701/PF-001



Cadet corps affiliated with Engineer Regiments utilize the term “**sapper**” to designate a Pte.

Cadet corps affiliated with Armoured Regiments utilize the term “**trooper**” to designate Pte.

Cadet corps affiliated with the Guard Regiments utilize the term “**guardsman**” to designate Pte.

In cadet corps affiliated with Artillery Regiments, the following terms are used:

- “**Gunner**” designates private;
- “**Bombardier**” designates corporal; and
- “**Master Bombardier**” designates master corporal.

CONFIRMATION OF TEACHING POINT 1

QUESTIONS

- Q1. Which is more senior, the rank of MCpl or Cpl?
- Q2. Describe the MWO rank badge.
- Q3. What other names may be utilized to denote the rank of Pte?

ANTICIPATED ANSWERS

- A1. MCpl.
- A2. Tudor crown surround by a laurel wreath.
- A3. Gunner, guardsman, trooper, sapper or private.

END OF LESSON CONFIRMATION

The cadets' participation in TP1 will serve as the confirmation of this lesson.

CONCLUSION

HOMEWORK/READING/PRACTICE

N/A.

METHOD OF EVALUATION

N/A.

CLOSING STATEMENT

The cadet, by identifying the ranks of the RCAC and the officers of the CF, will be able to interact more effectively with the different members of each organization.

INSTRUCTOR NOTES/REMARKS

N/A.

A-CR-CCP-701/PF-001

REFERENCES

- A0-001 A-AD-265-000/AG-001 DHH 3-2. (2001). *Canadian Forces Dress Instructions*. Ottawa, ON: The Department of National Defence.
- A0-009 A-AA-100-000/AA-003 Canadian Forces. (2006). *QR&O, Chapter 3, Section 1, Ranks and Designations of Ranks*. Ottawa, ON: The Department of National Defence.
- A2-030 D Cdts. (2005). CATO 40-03, *Army Cadet Ranks and Cadet Corps Establishment*. In *Cadet Administrative and Training Orders* (Vol. 4, 5 pages). Ottawa, ON.

MODIFIED LESSON SPECIFICATIONS AND INSTRUCTIONAL GUIDES – TP 1 OF EO M107.04

A-CR-CCP-701/PG-001

EO M107.04 – STATE THE AIMS AND MOTTO OF THE ARMY CADET PROGRAM

1. **Performance.** State the Aims and Motto of the Army Cadet Program.
2. **Conditions**
 - a. Given:
 - (1) supervision; and
 - (2) assistance as required.
 - b. Denied: N/A.
 - c. Environmental: Suitable classroom facilities or training area large enough to accommodate the entire group.
3. **Standard.** In accordance with specified references, the cadet shall:
 - a. become familiar with the mission and vision of the Cadet Program;
 - b. state the aims of the Army Cadet Program; and
 - c. state the motto of the Army Cadet Program.

4. **Teaching Points**

TP	Description	Method	Time	Ref
TP1	State the mission of the Cadet Program, which is to contribute to the development and preparation of youth for the transition to adulthood, enabling them to meet the challenges of modern society, through a dynamic, community-based program.	Interactive Lecture	10 min	A0-003

5. **Time**
 - a. Introduction/Conclusion: 5 min
 - b. Interactive Lecture: 10 min
 - c. Total: 15 min
6. **Substantiation.** The interactive lecture method was chosen as it best allows the instructor to make a semi-formal presentation of the material allowing the cadets to participate by asking or responding to questions, commenting on the material, or participating in short activities. This method appeals to auditory learners, with the potential for active participation in activities that appeal to tactile/kinaesthetic learners.
7. **References**
 - a. A0-010 D Cdts. (1999). CATO 11-03, *Cadet Program Mandate*. In *Cadet Administrative and Training Orders* (Vol. 1). Ottawa, ON.
 - b. C2-040 The Army Cadet League of Canada. (2006). *Policy 3.1: Aim of the Canadian Cadet Organizations*. Retrieved 25 May 2006, from http://www.armycadetleague.ca/templates/pdf/refmanual/english/pol_3_1.pdf.

8. **Training Aids**
 - a. Presentation aids (i.e. whiteboards/flipcharts/OHP) appropriate for classroom/training area; and
 - b. Paper and markers suitable for activities.
9. **Learning Aids.** N/A.
10. **Test Details.** There is no formal assessment of this EO. Instructors will confirm cadets' comprehension of the material during the end of lesson check.
11. **Remarks.** N/A.

A-CR-CCP-701/PF-001



ROYAL CANADIAN ARMY CADETS

GREEN STAR

INSTRUCTIONAL GUIDE



SECTION 4

EO M107.04 – DESCRIBE THE THREE AIMS OF THE CADET PROGRAM

Total Time: 15 min

PREPARATION

PRE-LESSON INSTRUCTIONS

Resources needed for the delivery of this lesson are listed in the lesson specification located at Chapter 4 of the QSP. Specific uses for said resources are identified throughout the Instructional Guide, within the teaching point for which they are required.

Review the lesson content and become familiar with the material prior to delivering the lesson.

PRE-LESSON ASSIGNMENT

N/A.

APPROACH

This lesson will be presented using the interactive lecture method. The interactive lecture method was chosen as it best allows the instructor to make a semi-formal presentation of the material allowing the cadets to participate by asking or responding to questions, commenting on the material, or participating in short activities. This method appeals to auditory learners, with the potential for active participation in activities that appeal to tactile/ kinaesthetic learners.

INTRODUCTION

REVIEW

N/A.

OBJECTIVES

By the end of the lesson the cadet shall be expected to state the aims of the army cadet program.

IMPORTANCE

Knowing the aims of the army cadet program are fundamental for any cadet. This information will give a better understanding of how the Cadet Program can help them develop both as a cadet and an individual.

A-CR-CCP-701/PF-001

Teaching Point 1

Describe the Three Aims of the Cadet Program

Time: 10 min

Method: Interactive Lecture



The aims of the Cadet Program are to:

- develop in youth the attributes of good citizenship and leadership;
- promote physical fitness; and
- stimulate the interest of youth in the sea, land and air activities of the Canadian Forces (CF).

DEVELOP IN YOUTH THE ATTRIBUTES OF GOOD CITIZENSHIP AND LEADERSHIP

The Cadet Program aims to assist in the development of cadets as good citizens and leaders.

Through citizenship and community services activities, the cadet develops an appreciation for community membership and involvement within cadet, local, regional, provincial, national and global communities. Cadets' active involvement will have a positive impact on local communities, which will contribute to community strength and vibrancy.

Through leadership activities, cadets develop interpersonal skills and assume responsibility as effective team members, leaders and dynamic coaches. They will develop the ability to conduct themselves in an ethical and socially responsible way.

PROMOTE PHYSICAL FITNESS

The Cadet Program aims to promote physical well-being. Cadets develop an understanding of the benefits of fitness and a healthy lifestyle. This understanding, combined with on-going participation in fitness activities, aids in the development of positive attitudes and behaviours that build resiliency within cadets and enable them to meet challenges.

STIMULATE THE INTEREST OF YOUTH IN THE SEA, LAND AND AIR ACTIVITIES OF THE CF

The Cadet Program aims to expose youth to the sea, land and air activities of the CF. Cadets develop elemental skills through introduction and interaction with their respective CF communities. The Cadet Program educates and promotes liaison with civilian maritime, adventure and aviation communities. These combined experiences and interactions are essential to the unique identity of the sea, army and air cadet organizations. Also, they distinguish the Cadet Program as a whole from other youth development programs.

CONFIRMATION OF TEACHING POINT 1

QUESTIONS

- Q1. What are the three aims of the Cadet Program?
- Q2. How does the Cadet Program promote physical fitness?
- Q3. How does the Cadet Program stimulate an interest in the sea, land and air activities of the Canadian Forces?

A-CR-CCP-701/PF-001

ANTICIPATED ANSWERS

- A1. Develop in youth the attributes of good citizenship and leadership, promote physical fitness and stimulate the interest of youth in the sea, land and air activities of the CF.
- A2. The Cadet Program aims to promote physical well-being. Cadets develop an understanding of the **benefits of fitness** and a healthy lifestyle. This understanding, combined with on-going **participation in fitness activities**, aids in the development of **positive attitudes** and behaviours that build resiliency within cadets and enable them to meet challenges.
- A3. The Cadet Program aims to expose youth to the sea, land and air activities of the CF. Cadets develop elemental skills through introduction and interaction with their respective CF communities. The Cadet Program educates and promotes liaison with civilian maritime, adventure and aviation communities. These combined experiences and interactions are essential to the unique identity of the Sea, Army and Air Cadet Organizations. Also, they **distinguish the Cadet Program** as a whole from other youth development programs.

END OF LESSON CONFIRMATION

The cadets' participation in TP1 will serve as the confirmation of this lesson.

CONCLUSION

HOMEWORK/READING/PRACTICE

N/A.

METHOD OF EVALUATION

N/A.

CLOSING STATEMENT

The aims of the Army Cadet Program provide the cadet with a greater understanding of what it means to be an Army Cadet. The tenets of aim will contribute to the development of a sense of pride in belonging to the Army Cadet Program.

INSTRUCTOR NOTES/REMARKS

N/A.

REFERENCES

- A0-010 Cdts. (1999). CATO 11-03, *Cadet Program Mandate*. In Cadet Administrative and Training Orders (Vol. 1). Ottawa, ON.
- C2-040 The Army Cadet League of Canada. (2006). *Policy 3.1: Aim of the Canadian Cadet Organizations*. Retrieved 25 May 2006, from http://www.armycadetleague.ca/templates/pdf/refmanual/english/pol_3_1.pdf.

THIS PAGE INTENTIONALLY LEFT BLANK

MODIFIED LESSON SPECIFICATIONS AND INSTRUCTIONAL GUIDES – TP 1 OF EO M222.02

A-CR-CCP-702/PG-001

EO M222.02 – DESCRIBE BEARINGS

1. **Performance.** Describe Bearings.
2. **Conditions**
 - a. Given:
 - (1) compass rose;
 - (2) supervision; and
 - (3) assistance as required.
 - b. Denied: N/A.
 - c. Environmental: Suitable classroom facility or training area large enough to accommodate the entire group.
3. **Standard.** In accordance with B-GL-382-005/PT-001, the cadet shall describe bearings by identifying the 16 points of a compass.

4. **Teaching Points**

TP	Description	Method	Time	Ref
TP1	Identify and explain the 16 points of a compass, to include: <ol style="list-style-type: none"> a. the 4 cardinal points; b. the 4 inter-cardinal points; and c. the 8 intermediate points. 	Interactive Lecture	10 min	A2-041 (p. 47)

5. **Time**
 - a. Introduction/Conclusion: 5 min
 - b. Interactive Lecture: 10 min
 - c. Total: 15 min
6. **Substantiation.** An interactive lecture was chosen for TP1 to present basic material, orient the cadets to bearings, and to generate interest.
7. **References.** A2-041 B-GL-382-005/PT-001 Canadian Forces. (2006). *Maps, Field Sketching, Compasses and the Global Positioning System*. Ottawa, ON: Department of National Defence.
8. **Training Aids**
 - a. Presentation aids (eg, whiteboard/flipchart/OHP) appropriate for classroom/training area;
 - b. Topographical map; and
 - c. Compass rose.
9. **Learning Aids**
 - a. Pencil; and
 - b. Compass rose.

10. **Test Details.** N/A.
11. **Remarks.** N/A.

A-CR-CCP-702/PF-001



ROYAL CANADIAN ARMY CADETS

RED STAR

INSTRUCTIONAL GUIDE



SECTION 2

EO M222.02 – DESCRIBE BEARINGS

Total Time: 15 min

PREPARATION

PRE-LESSON INSTRUCTIONS

Resources needed for the delivery of this lesson are listed in the lesson specification located in A-CR-CCP-702/PG-001, Chapter 4. Specific uses for said resources are identified throughout the Instructional Guide within the TP for which they are required.

Review the lesson content and become familiar with the material prior to delivering the lesson.

PRE-LESSON ASSIGNMENT

N/A.

APPROACH

This lesson will be presented using the interactive lecture method. The interactive lecture method was chosen as it best allows the instructor to make a semi-formal presentation of the material allowing the cadets to participate by asking or responding to questions, commenting on the material, or participating in short activities. This method appeals to auditory learners, with the potential for active participation in activities that appeal to tactile/ kinaesthetic learners.

INTRODUCTION

REVIEW

N/A.

OBJECTIVES

By the end of this lesson the cadet shall be expected to identify the 16 points of a compass.

IMPORTANCE

It is important for cadets to identify the 16 points on a compass as this will assist them in finding the direction of identifiable landmarks on a map. Cadets will rely on this skill set throughout navigation and expedition training.

A-CR-CCP-702/PF-001

Teaching Point 1

Identify and Explain the 16 Points of a Compass

Time: 10 min

Method: Interactive Lecture



Draw a compass rose (circle) on the board with the four cardinal points. Draw a new line each time you introduce the inter-cardinal and intermediate points.

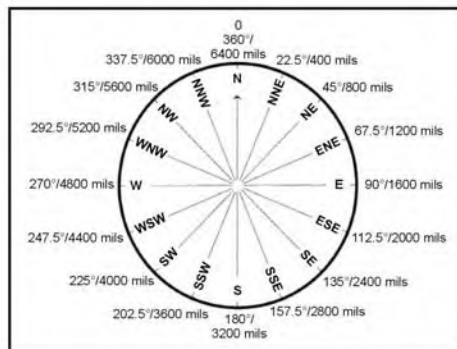

D Cds 3, 2007, Ottawa, ON: Department of National Defence

Figure 12-2-1 Compass Rose

FOUR CARDINAL POINTS

The four cardinal points of the compass, measured at right angles clockwise are north (N), east (E), south (S) and west (W). They can be easily remembered by the using mnemonics, such as "Never Eat Shredded Wheat".

FOUR INTER-CARDINAL POINTS

The four inter-cardinal points are located halfway between each of the cardinal points. Measured clockwise, they are:

1. north-east (NE);
2. south-east (SE);
3. south-west (SW); and
4. north-west (NW).

EIGHT INTERMEDIATE POINTS

The eight intermediate points are located halfway between each cardinal point and inter-cardinal point. Measured clockwise, they are:

1. north-north-east (NNE);
2. east-north-east (ENE);
3. east-south-east (ESE);

A-CR-CCP-702/PF-001

4. south-south-east (SSE);
5. south-south-west (SSW);
6. west-south-west (WSW);
7. west-north-west (WNNW); and
8. north-north-west (NNW).

CONFIRMATION OF TEACHING POINT 1

QUESTIONS

- Q1. What is a mnemonic used to remember the four cardinal points?
- Q2. What are the four inter-cardinal points?
- Q3. How many intermediate points are there?

ANTICIPATED ANSWERS

- A1. "Never Eat Shredded Wheat".
- A2. North-east (NE), south-east (SE), south-west (SW) and north-west (NW).
- A3. There are eight intermediate points.

END OF LESSON CONFIRMATION

The cadets' participation in TP1 will serve as the confirmation of this lesson.

CONCLUSION

HOMEWORK/READING/PRACTICE

N/A.

METHOD OF EVALUATION

N/A.

CLOSING STATEMENT

Being able to identify the 16 points on the compass is an important aspect of navigation training, as it allows cadets to identify direction when travelling from one point to another.

INSTRUCTOR NOTES/REMARKS

N/A.

REFERENCES

- A2-041 B-GL-382-005/PT-001 Canadian Forces. (2006). *Maps, Field Sketching, Compasses and the Global Positioning System*. Ottawa, ON: Department of National Defence.

THIS PAGE INTENTIONALLY LEFT BLANK

MODIFIED LESSON SPECIFICATIONS AND INSTRUCTIONAL GUIDES – TP 1 OF EO M222.03

A-CR-CCP-702/PG-001

EO M222.03 – IDENTIFY COMPASS PARTS

1. **Performance.** Identify Compass Parts.
2. **Conditions**
 - a. Given:
 - (1) compass;
 - (2) supervision; and
 - (3) assistance as required.
 - b. Denied: N/A.
 - c. Environmental: Suitable classroom facility or training area large enough to accommodate the entire group.
3. **Standard.** In accordance with B-GL-382-005/PT-001, the cadet shall identify compass parts.
4. **Teaching Points**

TP	Description	Method	Time	Ref
TP1	Identify and describe the parts of the compass, to include: <ol style="list-style-type: none"> a. sight; b. compass cover; c. sighting mirror; d. sighting line; e. luminous index point; f. compass dial; g. dial graduations; h. orienting arrow; i. romer 1:25 000; j. compass base plate; k. declination scale; l. compass meridian lines; m. magnetic needle; n. luminous orienting points; o. luminous index point; p. romer 1:50 000; q. safety cord or lanyard; r. adjustable wrist lock; s. screwdriver; and t. declination adjustment screw. 	Interactive Lecture	10 min	A2-041 (pp. 66 and 67)

5. **Time**

- | | | |
|----|--------------------------|--------|
| a. | Introduction/Conclusion: | 5 min |
| b. | Interactive Lecture: | 10 min |
| c. | Total: | 15 min |

6. **Substantiation.** An interactive lecture was chosen for TP1 to present basic material, orient the cadets to the compass, and generate interest.

7. **References**

- a. A2-036 A-CR-CCP-121/PT-001 D Cdts (2003). *Royal Canadian Army Cadet Reference Book*. Ottawa, ON: Department of National Defence.
- b. A2-041 B-GL-382-005/PT-001 Canadian Forces. (2006). *Maps, Field Sketching, Compasses and the Global Positioning System*. Ottawa, ON: Department of National Defence.

8. **Training Aids**

- a. Presentation aids (eg, whiteboard/flipchart/OHP) appropriate for classroom/training area; and
- b. Compass.

9. **Learning Aids.** Compass.

10. **Test Details.** N/A.

11. **Remarks.** N/A.

A-CR-CCP-702/PF-001



ROYAL CANADIAN ARMY CADETS

RED STAR

INSTRUCTIONAL GUIDE



SECTION 3

EO M222.03 – IDENTIFY AND DESCRIBE THE PARTS OF THE COMPASS

Total Time: 15 min

PREPARATION

PRE-LESSON INSTRUCTIONS

Resources needed for the delivery of this lesson are listed in the lesson specification located in A-CR-CCP-702/PG-001, Chapter 4. Specific uses for said resources are identified throughout the Instructional Guide within the TP for which they are required.

Review the lesson content and become familiar with the material prior to delivering the lesson.

PRE-LESSON ASSIGNMENT

N/A.

APPROACH

An interactive lecture was chosen for this lesson to present basic material, orient the cadets to the compass, and generate interest.

INTRODUCTION

REVIEW

N/A.

OBJECTIVES

By the end of this lesson the cadet shall have identified the parts of the compass.

IMPORTANCE

It is important for cadets to be able to use a compass while navigating during expedition training. Each part of the compass has a specific name used to identify the part and its function. Cadets will rely on this information throughout navigation and expedition training.

A-CR-CCP-702/PF-001

Teaching Point 1

Identify and Describe the Parts of the Compass

Time: 10 min

Method: Interactive Lecture



Divide cadets into equal groups according to the number of compasses available. Starting with the compass opened, use the diagram in [Figure 12-3-1](#) to identify the parts of the compass from the top (sight) to the bottom (screwdriver).

PARTS OF THE COMPASS

A – Sight. Located at the top of the compass cover, the sight is used to align an objective or bearing.

B – Compass Cover. The compass cover protects the compass dial and houses the sighting mirror.

C – Sighting Mirror. The sighting mirror is used to see the compass dial while setting a bearing.

D – Sighting Line. The sighting line is used when aligning the objective or bearing.

E – Luminous Index Point. The luminous index point at the top of the compass dial is where a bearing is set and read from.

F – Compass Dial. The compass dial houses the magnetic needle, the orienting arrow and the declination scale on the inside and the dial graduations on the outside.

G – Dial Graduations. The compass dial is graduated in 50 mil divisions from 0 to 6400 mils, or 2 degree divisions from 0 to 360 degrees. The dial is rotated by hand.

A-CR-CCP-702/PF-001

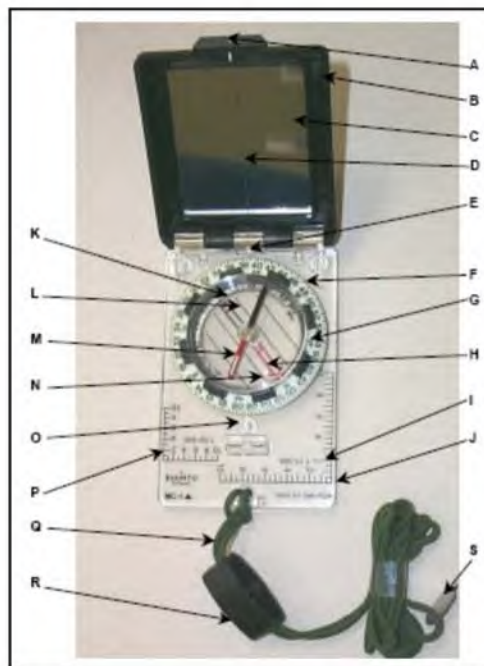

A-CR-CCP-121/PT-001 (p. 5-33)

Figure 12-3-1 Compass



This Instructional Guide is good for use with compasses that have dial graduations in either mils or degrees.

H – Orienting Arrow. The red orienting arrow is located inside the compass dial and is used to line up the magnetic needle. The orienting arrow is always set at 00 mils/degrees.

I – Romer 1:25 000. This romer is used to measure GR on maps with a 1:25 000 scale.

J – Compass Base Plate. The compass base plate is a clear piece of flat plastic, to which the cover, dial and lanyard are attached.

K – Declination Scale. The declination scale is used to compensate for the variation of magnetic declination between the compass and the map being used.

L – Compass Meridian Lines. Compass meridian lines are black or red lines inside the compass dial and are used to line up the compass dial with the grid lines on a map.

M – Magnetic Needle. The magnetic needle spins freely and points to magnetic north. The south end of the compass needle is black and the north end, with a luminous patch, is red.

A-CR-CCP-702/PF-001



When the magnetic needle is lined up with the red orienting arrows, the mnemonic "Red in the Bed" is used to remember which end of the needle belongs between the arrows.

N – Luminous Orienting Points. There are two luminous orienting points located on either side of the orienting arrow.

O – Luminous Index Point. The luminous orienting point at the bottom of the compass dial is where a back bearing is read from.

P – Romer 1:50 000. This romer is used to measure GR on maps with a 1:50 000 scale.

Q – Safety Cord or Lanyard. The safety cord is used to fasten the compass to the body.

R – Adjustable Wrist Lock. The adjustable wrist lock is used to attach the compass to the wrist.

S – Screwdriver. The tiny screwdriver at the end of the safety cord is used to turn the screw to adjust the declination scale.

T – Declination Adjustment Screw. The declination adjustment screw is located on the back side of the compass dial and is used to adjust the declination scale (not shown).



When exposed to direct light, all luminous parts of the compass will glow in the dark making operating the compass at night possible.

CONFIRMATION OF TEACHING POINT 1

QUESTIONS

- Q1. What is the maximum number of mils or degrees on the dial graduations?
- Q2. What mnemonic is use for putting the magnetic needle between the orienting arrows?
- Q3. What direction does the red part of the magnetic needle point?

ANTICIPATED ANSWERS

- A1. 6400 mils or 360 degrees.
- A2. "Red in the Bed".
- A3. Magnetic north.

END OF LESSON CONFIRMATION

QUESTIONS

- Q1. What is the screwdriver on the compass used for?
- Q2. What two directions are used to describe declination?
- Q3. What direction is the declination adjusting screw turned to set an east declination?

A-CR-CCP-702/PF-001

ANTICIPATED ANSWERS

- A1. To turn the declination adjusting screw.
- A2. East and west.
- A3. Left.

CONCLUSION

HOMEWORK/READING/PRACTICE

N/A.

METHOD OF EVALUATION

N/A.

CLOSING STATEMENT

Compasses are used during navigation and trekking training exercises. Identification of the parts and the proper use of the compass is essential to ensuring accurate navigation.

INSTRUCTOR NOTES/REMARKS

N/A.

REFERENCES

- A2-036 A-CR-CCP-121/PT-001 D Cdts (2003). *Royal Canadian Army Cadet Reference Book*. Ottawa, ON: Department of National Defence.
- A2-041 B-GL-382-005/PT-001 Canadian Forces. (2006). *Maps, Field Sketching, Compasses and the Global Positioning System*. Ottawa, ON: Department of National Defence.

THIS PAGE INTENTIONALLY LEFT BLANK

MODIFIED LESSON SPECIFICATIONS AND INSTRUCTIONAL GUIDES – TP 1 OF EO M122.01

A-CR-CCP-701/PG-001

EO M122.01 – IDENTIFY TYPES OF MAPS

1. **Performance.** Identify Types of Maps.
2. **Conditions**
 - a. Given:
 - (1) examples of different types of maps;
 - (2) topographical map worksheet;
 - (3) supervision; and
 - (4) assistance as required.
 - b. Denied: N/A.
 - c. Environmental: Suitable classroom facilities or training area large enough to accommodate entire group during map work.
3. **Standard.** In accordance with specified references the cadet shall fold a topographical map worksheet, ensuring that the map identification located in the bottom right corner of the map is displayed for easy reference.
4. **Teaching Points**

TP	Description	Method	Time	Ref
TP1	Explain, demonstrate, and have cadets practice folding a map (worksheet) by: <ol style="list-style-type: none"> a. laying the map face up and folding map in half by bringing the top of the map sheet down to the bottom of the map sheet; b. folding the top half of the map sheet up into half again, then turning map over and folding bottom half to match the top half; c. folding the ends of the map into half from left to right; and d. folding each of the open ends back into half again so that the map name and index to adjacent map sheets appear on the outside. 	Demonstration and Performance	10 min	A2-004

5. **Time**
 - a. Introduction/Conclusion: 5 min
 - b. Demonstration and Performance: 10 min
 - c. Total: 15 min
6. **Substantiation.** The demonstration-performance method was chosen for TP1 to allow cadets to participate in supervised exploration of practical instructional material. This method provides the instructor the opportunity to introduce the subject matter, demonstrate and explain procedures, and supervise the cadets while they imitate the skill. This method appeals to all learning styles.

7. **References.** A2-004 B-GL-382-005-FP-001 Canadian Forces. (1976). *Maps, Fields, Sketching, and Compasses* (Vol. 8). Ottawa, ON: The Department of National Defence.
8. **Training Aids**
 - a. Presentation aids (i.e. whiteboard/flipchart/OHP) appropriate for classroom/training area;
 - b. Examples of different types of maps, to include:
 - (1) topographical;
 - (2) orienteering;
 - (3) political;
 - (4) street and road;
 - (5) statistical;
 - (6) digital, including GPS;
 - (7) relief;
 - (8) outline; and
 - (9) air photo; and
 - c. Waterproofing agent for illustration purposes, (e.g. waterproof bags and zipper type).
9. **Learning Aids.** Topographical map worksheet.
10. **Test Details.** There is no formal assessment of this EO. Instructors will confirm the cadets' knowledge of types of maps, care of a map and their ability to fold a map during the end of lesson check.
11. **Remarks**
 - a. Types of maps will be limited to what is available at the corps level. Instructors should attempt to obtain as many examples as are available. Where local resources allow, products such as clear contact paper and chemical coating may be demonstrated.
 - b. Actual maps are not required to practice folding a map. A topographical map worksheet, 8-1/2-in. by 11-in. sheet of paper, newspaper, or retail flyer may be used to represent a map.



ROYAL CANADIAN ARMY CADETS

GREEN STAR

INSTRUCTIONAL GUIDE



SECTION 1

EO M122.01 – IDENTIFY TYPES OF MAPS

Total Time: 15 min

PREPARATION

PRE-LESSON INSTRUCTIONS

Resources needed for the delivery of this lesson are listed in the lesson specification located at Chapter 4 of the QSP. Specific uses for said resources are identified throughout the Instructional Guide, within the teaching point for which they are required.

Review the lesson content, and become familiar with the material prior to instruction of this lesson.

PRE-LESSON ASSIGNMENT

N/A.

APPROACH

The demonstration and performance method was chosen to allow cadets to participate in supervised exploration of practical instructional material. This method provides the instructor the opportunity to introduce the subject matter, demonstrate and explain procedures, and supervise the cadets while they imitate the skill. This method appeals to all learning styles.

INTRODUCTION

REVIEW

N/A.

OBJECTIVES

By the end of this period the cadet shall be expected to properly fold a topographical map sheet.

IMPORTANCE

It is important to know how to fold and maintain these maps properly so they will remain serviceable and in good condition.

Teaching Point 1

Explain and Demonstrate How to Fold a Map

Time: 10 min

Method: Demonstration and Performance

FOLDING A MAP

To properly fold a map, the following steps are to be followed:

A-CR-CCP-701/PF-001

1. Lay the map face up, then fold map in half by bringing the top (north) of the map sheet down to the bottom (south) of the map sheet. Crease where the bend in the map has occurred; this is the centre of the map (see Figure 11-1-1, Step 1).
2. Fold the top half of the map sheet into half again, then turn the map over and fold the bottom half to match the top half (see Figure 11-1-1, Step 2).
3. Fold the ends of the map into half from left to right (see Figure 11-1-1, Step 3).
4. Fold each of the open ends back into half again so that the map name and index to adjacent map sheet appears on the outside (the map should look like the letter M). (see Figure 11-1-1, Step 4).

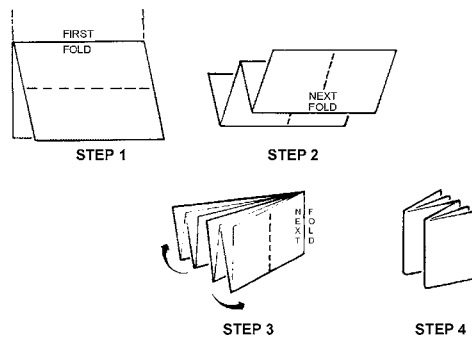

A-CR-CCP-121/PT-001, Royal Canadian Army Cadets Reference Book

Figure 11-1-1 Folding of a Map

CONFIRMATION OF TEACHING POINT 1

Have each cadet practice folding the topographical map sheet (located in the Green Star Handbook) in the method described above. An easy way to remember how to fold a map is north to south, south to north, east to west and west to east.

END OF LESSON CONFIRMATION

The cadets' participation in folding a map will serve as the confirmation of this lesson.

CONCLUSION

HOMEWORK/READING/PRACTICE

N/A.

METHOD OF EVALUATION

N/A.

CLOSING STATEMENT

It is important to know how to fold and maintain maps properly so they will remain in good condition for a long time.

A-CR-CCP-701/PF-001

INSTRUCTOR NOTES/REMARKS

N/A.

REFERENCES

A2-004 B-GL-382-005/FP-001 Canadian Forces. (1976). *Maps, Fields, Sketching, and Compasses* (Vol. 8). Ottawa, ON: National Defence.

THIS PAGE INTENTIONALLY LEFT BLANK

MODIFIED LESSON SPECIFICATIONS AND INSTRUCTIONAL GUIDES – TP 1 OF EO M221.05

A-CR-CCP-702/PG-001

EO M221.05 – TIE KNOTS

1. **Performance.** Tie Knots.
2. **Conditions**
 - a. Given:
 - (1) rope for tying knots;
 - (2) railing or dowel;
 - (3) supervision; and
 - (4) assistance as required.
 - b. Denied: N/A.
 - c. Environmental: Suitable classroom facilities or training area large enough to accommodate the entire group.
3. **Standard.** In accordance with specified references, the cadet shall:
 - a. tie and describe the uses of the following knots:
 - (1) bowline;
 - (2) fisherman’s knot;
 - (3) double fisherman’s knot; and
 - (4) double overhand running knot; and
 - b. coil a rope.
4. **Teaching Points**

TP	Description	Method	Time	Ref
TP1	Explain the uses of, demonstrate, and allow time for the cadets to practice tying the following knots: a. bowline; and b. fisherman’s knot. Note: Provide cadets with a handout with tying instructions.	Demonstration and Performance	10 min	C2-007 (p. 116, 117, pp. 162–163, and p. 177)

5. **Time**
 - a. Introduction/Conclusion: 5 min
 - b. Demonstration and Performance: 10 min
 - c. Total: 15 min
6. **Substantiation.** Demonstration and performance was chosen for TP1 as it allows the instructor to explain and demonstrate knot-tying while providing an opportunity for the cadets to practice knot-tying under supervision.

A-CR-CCP-702/PG-001

7. **References**

- a. C2-007 (ISBN 0-7858-1446-9) Pawson, D. (2001). *Pocket Guide to Knots and Splices*. Edison, NJ: Chartwell Books, Inc.
- b. C2-073 (ISBN 0-688-01226-4) Bigon, M. and Regazzoni, G. (1982). *The Morrow Guide to Knots*. New York: Quill/William Morrow.

8. **Training Aids**

- a. Rope for tying knots;
- b. Flipchart paper/blackboard/chalkboard; and
- c. Marker/chalk.

9. **Learning Aids**

- a. Rope for tying knots;
- b. Railing or dowel; and
- c. Knot tying handouts.

10. **Test Details.** N/A.

11. **Remarks**

- a. The rope used for tying knots should be 6 or 7 mm diameter.
- b. Cadets will require at least 6 m (20 feet) of rope for coiling.

A-CR-CCP-702/PF-001



ROYAL CANADIAN ARMY CADETS

RED STAR

INSTRUCTIONAL GUIDE



SECTION 5

EO M221.05 – TIE KNOTS

Total Time: 15 min

PREPARATION

PRE-LESSON INSTRUCTIONS

Resources needed for the delivery of this lesson are listed in the lesson specification located in A-CR-CCP-702/PG-001, Chapter 4. Specific uses for said resources are identified throughout the Instructional Guide within the TP for which they are required.

Review the lesson content and become familiar with the material prior to delivering the lesson.

Make copies of knot-tying instructions, located at [Annex C](#).

PRE-LESSON ASSIGNMENT

N/A.

APPROACH

Demonstration and performance was chosen for this lesson as it allows the instructor to explain and demonstrate knot-tying while providing an opportunity for the cadets to practice knot-tying under supervision.

INTRODUCTION

REVIEW

N/A.

OBJECTIVES

By the end of this lesson the cadet shall be expected to coil a rope and tie the following knots:

- bowline; and
- fisherman's knot.

IMPORTANCE

It is important for cadets to know how to tie knots. Knots can be used during field training, for building shelters, securing equipment, and also in everyday life.

A-CR-CCP-702/PF-001

Teaching Point 1

Explain the Uses of, Demonstrate, and Allow Time to Practice Tying Knots

Time: 10 min

Method: Practical Activity



Provide an explanation and demonstration of the complete knot and then break the knot down into its steps.

Provide a demonstration of each step and have the cadets complete each step. Ensure the cadets have enough time to complete each step.

Each knot must be instructed individually. Distribute handouts with tying instructions (located at [Annex C](#)).

BOWLINE

Uses. In climbing, it is used as a safety measure during ascent and is clipped into the carabiner. It is often called the rescue knot because it makes a simple loop that does not slip. It can be used to tie around yourself, to throw to someone who needs a lifeline, or to secure objects (such as canoes to a wharf).

Qualities. It does not slip, come loose, or jam.

Faults. It is difficult to untie when the rope is under strain.

Procedure

1. With the standing part of the rope away from you, take the working end in your right hand and place it on top of the standing part.
2. Put your thumb under the standing part.
3. Twist your right hand 180 degrees away from you, to form a simple over hand loop (looks like a number six), and pull the working end up through.
4. Take the working end round behind the standing part.
5. Bring the working end down through the loop. Tighten the bowline by holding on to the bight formed by the end and pulling hard on the standing part.

A-CR-CCP-702/PF-001

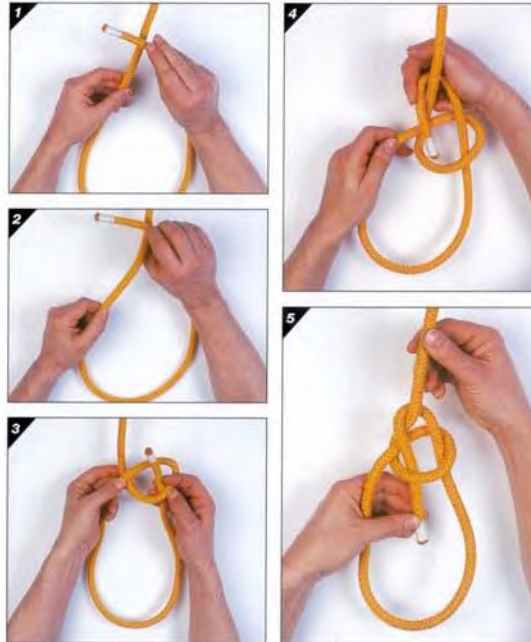

Pawson, D., Pocket Guide to Knots & Splices, Chartwell Books, Inc. (p. 164)

Figure 11-5-1 Bowline

FISHERMAN'S KNOT

Uses. To join two pieces of rope together. It is commonly used by anglers and climbers.

Qualities. It does not slip, come loose, or jam.

Faults. It is difficult to untie when fine rope is used.

Procedure

1. Lay the ropes alongside each other, end to end. Take one of the ropes and bring it over the other and under itself.
2. Make an overhand knot around the second rope.
3. Make an overhand knot around the standing part of the first rope.
4. Slide together to complete the knot.
5. Tighten to finish the fisherman's knot.
6. Tape ends if used in climbing to avoid slipping.

A-CR-CCP-702/PF-001

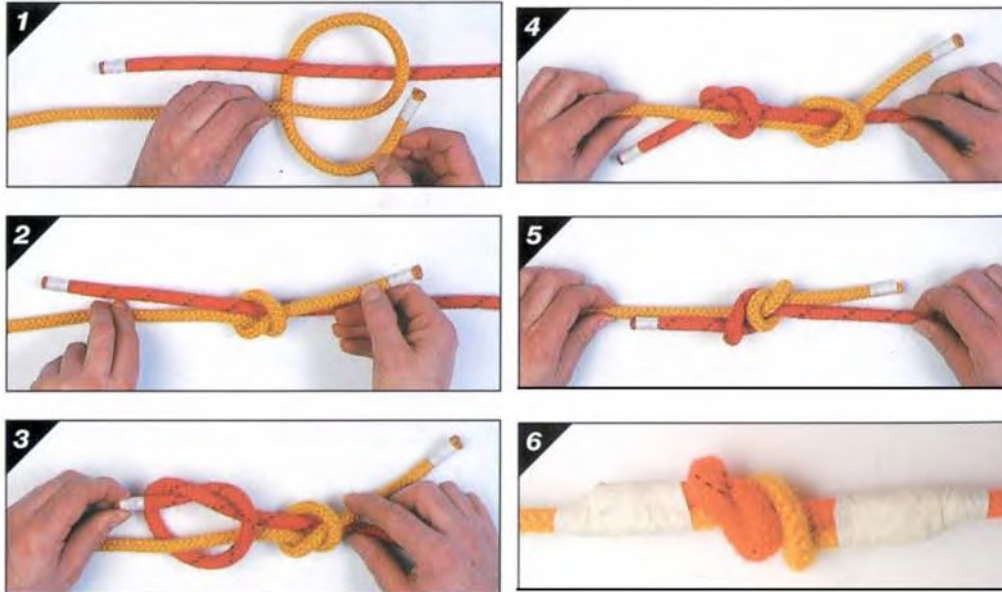

Pawson, D., Pocket Guide to Knots & Splices, Chartwell Books, Inc. (p. 116)

Figure 11-5-2 Fisherman's Knot

CONFIRMATION OF TEACHING POINT 1

Tie the following knots:

- bowline; and
- fisherman's knot.

END OF LESSON CONFIRMATION

The cadets' participation in tying knots will serve as the confirmation of this lesson.

CONCLUSION

HOMEWORK/READING/PRACTICE

N/A.

METHOD OF EVALUATION

N/A.

A-CR-CCP-702/PF-001

CLOSING STATEMENT

Knowing what knots to tie when situations arise is an important aspect of field training and can also be used in everyday life. Being able to construct a quality knot will prove useful in a variety of situations such as climbing, towing, and even making a glasses strap or a strap for sunglasses when other means are not available.

INSTRUCTOR NOTES/REMARKS

N/A.

REFERENCES

- C2-007 (ISBN 0-7858-1446-9) Pawson, D. (2001). *Pocket Guide to Knots and Splices*. Edison, NJ: Chartwell Books, Inc.
- C2-073 (ISBN 0-688-01226-4) Bigon, M. and Regazzoni, G. (1982). *The Morrow Guide to Knots*. New York, NY: Quill/William Morrow.

THIS PAGE INTENTIONALLY LEFT BLANK

MODIFIED LESSON SPECIFICATIONS AND INSTRUCTIONAL GUIDES – TP 1 OF EO M221.09

A-CR-CCP-702/PG-001

EO M221.09 – MAINTAIN SECTION EQUIPMENT FOLLOWING A FIELD TRAINING EXERCISE (FTX)

1. **Performance.** Maintain Section Equipment Following a Field Training Exercise (FTX).
2. **Conditions**
 - a. Given:
 - (1) two-burner naphtha stove;
 - (2) dual-generator naphtha lantern;
 - (3) pot set;
 - (4) 4-lb axe (36-inch handle);
 - (5) 24-inch bow saw;
 - (6) ground sheet;
 - (7) supervision; and
 - (8) assistance as required.
 - b. Denied: N/A.
 - c. Environmental: Suitable classroom facilities or training area large enough to accommodate the entire group, after a weekend bivouac exercise.
3. **Standard.** In accordance with *Camping and Wilderness Survival: The Ultimate Outdoors Book*, the cadet shall clean and a groundsheet.

4. **Teaching Points**

TP	Description	Method	Time	Ref
TP1	Explain, demonstrate and have the cadets practice cleaning and storing groundsheets, to include: <ol style="list-style-type: none"> a. washing and drying; b. folding; and c. storing. 	Demonstration and Performance	10 min	

5. **Time**
 - a. Introduction/Conclusion: 5 min
 - b. Demonstration and Performance: 10 min
 - c. Total: 15 min
6. **Substantiation.** Demonstration and performance was chosen for this lesson as it allows the instructor to explain and demonstrate the cleaning and storing of section equipment while providing an opportunity for the cadets to practice these skills.
7. **References.** C0-111 978-0-9740820-2-8 Tawrell, P. (2006). *Camping and Wilderness Survival: The Ultimate Outdoors Book* (2nd ed.). Lebanon, NH: Leonard Paul Tawrell.
8. **Training Aids.** Groundsheet.

9. **Learning Aids.** Groundsheet.
10. **Test Details.** N/A.
11. **Remarks.** Equipment used on the previous weekend bivouac/survival FTX may be used for demonstration.

A-CR-CCP-702/PF-001



ROYAL CANADIAN ARMY CADETS

RED STAR

INSTRUCTIONAL GUIDE



SECTION 9

EO M221.09 – MAINTAIN SECTION EQUIPMENT FOLLOWING A FIELD TRAINING EXERCISE (FTX)

Total Time: 15 min

PREPARATION

PRE-LESSON INSTRUCTIONS

Resources needed for the delivery of this lesson are listed in the lesson specification located in A-CR-CCP-702/PG-001, Chapter 4. Specific uses for said resources are identified throughout the Instructional Guide within the TP for which they are required.

Review the lesson content and become familiar with the material prior to delivering the lesson.

During each TP each group should be given a groundsheet. Have cadets follow along with the instruction, maintaining the equipment as it is covered.

PRE-LESSON ASSIGNMENT

N/A.

APPROACH

Demonstration and performance was chosen for this lesson as it allows the instructor to explain and demonstrate the cleaning and storing of section equipment while providing an opportunity for the cadets to practice these skills.

INTRODUCTION

REVIEW

N/A.

OBJECTIVES

By the end of this lesson the cadet shall be expected to clean and store groundsheet.

IMPORTANCE

It is important for cadets to learn how to clean and store groundsheet. Cleaning and storing equipment prolongs the life of the equipment. Through regimented cleaning practices, equipment will be slow to corrode and rust ensuring a long life.

A-CR-CCP-702/PF-001

Teaching Point 1

**Explain, Demonstrate and Have the Cadets Practice
Cleaning and Storing Groundsheets**

Time: 10 min

Method: Demonstration and Performance



Provide each group with a groundsheet. Have cadets follow along with the instruction, cleaning and folding the groundsheet as it is covered.

WASHING AND DRYING

Cleaning a groundsheet is only required when it is noticeably covered in dirt or clay. If the groundsheet must be washed, use only water. Any type of cleaning solution will remove the waterproofing elements of the groundsheet. Ensure to thoroughly dry the surfaces, as left over moisture may break down and weaken the groundsheet.

FOLDING

To fold the groundsheet complete the following steps:

1. Ensure the groundsheet is completely dry.
2. Lay the groundsheet out, with the inside facing up (Step 1, [Figure 11-9-1](#)).
3. Fold the ends in to make a rectangle (Step 2, [Figure 11-9-1](#)).
4. Fold in half by bringing the right side to the left side (Step 3, [Figure 11-9-1](#)).
5. Fold the ends to the centre – right end to the centre, left end to the centre (Step 4, [Figure 11-9-1](#)).
6. Fold in half bringing right side to the left side (Step 5, [Figure 11-9-1](#)).
7. If the storage bin is smaller make more folds following the same pattern to reach the desired size for storage.

A-CR-CCP-702/PF-001



STEP 1



STEP 2



STEP 3

Figure 11-9-1 (Sheet 1 of 2) Folding a Groundsheet
D Cds 3, 2007, Ottawa, ON: Department of National Defence

A-CR-CCP-702/PF-001



STEP 4



STEP 5

Figure 11-9-1 (Sheet 2 of 2) Folding a Groundsheet
D Cdts 3, 2007, Ottawa, ON: Department of National Defence

A-CR-CCP-702/PF-001

STORING

The groundsheet should be stored in a cool, dry location out of direct sunlight. Storage bins or large plastic containers work well to organize and store groundsheets.

CONFIRMATION OF TEACHING POINT 1



The cadets' participation in folding a groundsheet will serve as the confirmation of this TP. Questions have been provided if additional confirmation is required.

QUESTIONS

- Q1. What should be used to clean a groundsheet?
- Q2. What would a cleaning solution do to a groundsheet?
- Q3. Where should a groundsheet be stored?

ANTICIPATED ANSWERS

- A1. Water should be used to clean a groundsheet.
- A2. A cleaning solution may damage or remove the waterproofing of the groundsheet.
- A3. A groundsheet should be stored in a cool dry location out of direct sunlight.

END OF LESSON CONFIRMATION

The cadets' participation in cleaning and inspecting the equipment will serve as the confirmation of this lesson.

CONCLUSION

HOMEWORK/READING/PRACTICE

N/A.

METHOD OF EVALUATION

N/A.

CLOSING STATEMENT

The ability to clean and store groundsheets in the field will prolong its life. Allowing cadets to clean and maintain section equipment will develop a sense of ownership, ensure the items are well cared for and will ensure they last for others to use.

INSTRUCTOR NOTES/REMARKS

N/A.

A-CR-CCP-702/PF-001

REFERENCES

C0-111 (ISBN 978-0-9740820-2-8) Tawrell, P. (2006). *Camping and Wilderness Survival: The Ultimate Outdoors Book* (2nd ed.). Lebanon, NH: Leonard Paul Tawrell.

MODIFIED LESSON SPECIFICATIONS AND INSTRUCTIONAL GUIDES – TP 1 OF EO M122.05

A-CR-CCP-701/PG-001

EO M122.05 – DETERMINE A GRID REFERENCE

1. **Performance.** Determine a Grid Reference.
2. **Conditions**
 - a. Given:
 - (1) topographical/military maps;
 - (2) material to construct a romer;
 - (3) supervision; and
 - (4) assistance as required.
 - b. Denied: N/A.
 - c. Environmental: Suitable classroom facilities or training area large enough to accommodate entire group during map work.
3. **Standard.** In accordance with specified references, the cadet shall determine four- and six-figure Grid References (GR) (within the correct grid, and to 100 metres accuracy, respectively), for a series of features on a topographical map.

4. **Teaching Points**

TP	Description	Method	Time	Ref
TP1	<p>Explain, demonstrate, and have the cadets practice determining a four-figure GR, in that:</p> <ol style="list-style-type: none"> a. four-figure GRs will have four numerical digits derived from the numbers assigned to the eastings (X axis) and northings (Y axis) on the map sheet; b. the numbers are listed by recording the two-digit easting followed by the two-digit northing; and c. the grid lines that intersect in the bottom left corner of the grid square in question identify the grid square. <p>Note: Instructors will provide three-points for cadets to use to identify the four-figure GR, and three points for cadets to locate using a four-figure GR.</p>	Demonstration and Performance	10 min	A2-004 (Chapter 6, art 602)

5. **Time**
 - a. Introduction/Conclusion: 5 min
 - b. Demonstration and Performance: 10 min
 - c. Total: 15 min
6. **Substantiation.** The demonstration-performance method was chosen to allow cadets to participate in supervised exploration of practical instructional material. This method provides the instructor the

A-CR-CCP-701/PG-001

opportunity to introduce the subject matter, demonstrate and explain procedures, and supervise the cadets while they imitate the skill. This method appeals to all learning styles.

7. **References.** A2-004 B-GL-382-005-FP-001 Canadian Forces. (1976). *Maps, Fields, Sketching, and Compasses* (Vol. 8). Ottawa, ON: The Department of National Defence.
8. **Training Aids**
 - a. Presentation aids (i.e. whiteboard/flipchart/OHP) appropriate for classroom/training area;
 - b. Topographical/military maps;
 - c. Compass with romer; and
 - d. Example of constructed romer.
9. **Learning Aids**
 - a. Topographical/military maps (one per two cadets); and
 - b. Materials for the construction of a romer.
10. **Test Details.** There is no formal assessment of this EO. Instructors will confirm the cadets' knowledge of determining four- and six-figure GRs during the end of lesson check.
11. **Remarks.** Cadets are to be provided with adequate time during FTXs to practice this skill.

A-CR-CCP-701/PF-001



ROYAL CANADIAN ARMY CADETS

GREEN STAR

INSTRUCTIONAL GUIDE



SECTION 5

EO M122.05 – DEMONSTRATE A GRID REFERENCE

Total Time: 15 min

PREPARATION

PRE-LESSON INSTRUCTIONS

Resources needed for the delivery of this lesson are listed in the lesson specification located at Chapter 4 of the QSP. Specific uses for said resources are identified throughout the Instructional Guide, within the teaching point for which they are required.

Review the lesson content and become familiar with the material prior to delivering the lesson.

Prior to instructing this lesson the instructor shall pre-select grid references to be used in the practical components of this lesson.

PRE-LESSON ASSIGNMENT

N/A.

APPROACH

The demonstration and performance method was chosen to allow cadets to participate in supervised exploration of practical instructional material. This method provides the instructor the opportunity to introduce the subject matter, demonstrate and explain procedures, and supervise the cadets while they imitate the skill. This method appeals to all learning styles.

INTRODUCTION

REVIEW

N/A.

OBJECTIVES

By the end of this lesson the cadet shall be expected to determine four-figure Grid Reference (GR) (within +/- 1000 and 100 metres accuracy, respectively), for a series of features on a topographical map.

IMPORTANCE

As an army cadet it is important to know how to use the grid system. Since the grid system is the basis of map reading, the concept of a four-figure GR will be a stepping stone to becoming a strong map-reader. A GR details the location of a grid square on a map, and prevents confusion about location. Communication about exact locations over the radio is made possible with an understanding of a GR.

A-CR-CCP-701/PF-001

Teaching Point 1

Explain and Demonstrate a Four-Figure GR

Time: 10 min

Method: Interactive Lecture

GRID REFERENCE

The military traditionally identify grid lines by stating the two-digit number of each grid line. When a location is identified using the grid system it is called a "Grid Reference" (GR). When giving a GR to a square, the reference is always to the southwest (bottom left) corner of the square. GRs are always given with the easting value first, followed by the northing value.

FOUR-FIGURE GR

A four-figure GR is used to identify a specific 1000 metre by 1000 metres grid square. It will have four numerical digits derived from the numbers assigned to the eastings on the X-axis, and the northings on the Y-axis, where the grid lines intersect at the bottom left corner of the grid square.

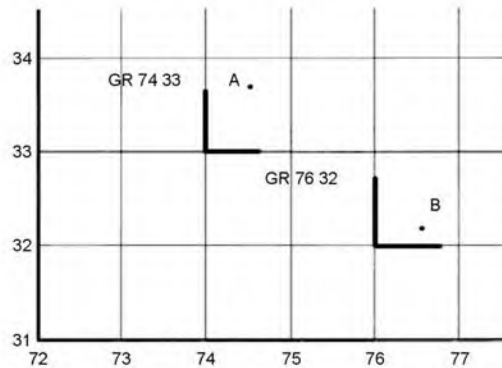

B-GL-382-005/PF-001, Military Training, Volume 8, Maps, Field Sketching and Compasses

Figure 11-5-1 Four-Figure GR



The instructor will provide a minimum of three practice points for the cadets to use in determining a four-figure GR. It is important for the cadet to be equally able to identify a location on a map when given the GR and to determine the GR for a location indicated on a map.

CONFIRMATION OF TEACHING POINT 1

QUESTIONS

- Q1. When giving a GR, the reference is always to which corner of the square?
- Q2. When giving a four-figure GR, in what order are the numbers given?
- Q3. A four-figure GR identifies a grid square of what size?

ANTICIPATED ANSWERS

- A1. Southwest or bottom left corner.

A-CR-CCP-701/PF-001

A2. Eastings then northings, or X-axis then Y-axis.

A3. 1000 metres by 1000 metres.

END OF LESSON CONFIRMATION

The instructor shall provide two points for the cadets to use in determining four-figure GRs.

CONCLUSION

HOMEWORK/READING/PRACTICE

N/A.

METHOD OF EVALUATION

N/A.

CLOSING STATEMENT

Knowing how to determine a four-figure GR is essential for functioning safely in the field, for determining the accurate location of an object or oneself, and for communicating that position to others.

INSTRUCTOR NOTES/REMARKS

N/A.

REFERENCES

A2-004 B-GL-382-005-FP-001 Canadian Forces. (1976). *Maps, Fields, Sketching, and Compasses* (Vol. 8). Ottawa, ON: National Defence.

THIS PAGE INTENTIONALLY LEFT BLANK

MODIFIED LESSON SPECIFICATIONS AND INSTRUCTIONAL GUIDES – TP 1 OF EO M121.02

A-CR-CCP-701/PG-001

EO M121.02 – TRANSPORT PERSONAL EQUIPMENT

1. **Performance.** Transport Personal Equipment.
2. **Conditions**
 - a. Given:
 - (1) examples of equipment;
 - (2) supervision; and
 - (3) assistance as required.
 - b. Denied: N/A.
 - c. Environmental:
 - (1) in-house training: suitable classroom facilities or training area large enough to accommodate entire group; and
 - (2) practical application: field setting, during a weekend bivouac FTX.
3. **Standard.** In accordance with specified references the cadet shall participate in a weekend bivouac FTX that will be of two full days and one evening's duration. They are required to pack and transport their personal equipment to and from the FTX area. Depending on the means by which they will travel to the training area, and the resources available to the cadet corps in terms of backpack availability, this could range from walking into the site carrying a rucksack to being transported by vehicle and dropped off at the site.
4. **Teaching Points**

TP	Description	Method	Time	Ref
TP1	Explain and demonstrate how to properly wear a backpack, by: <ol style="list-style-type: none"> a. loosening shoulder straps; b. bending the knees and holding the shoulder straps; c. lifting and resting the pack on the right (left) thigh; d. putting the right (left) arm through the shoulder strap and swinging it onto the back; e. putting the left (right) arm through the other shoulder strap; and f. clipping the hip belt and tightening the shoulder straps. 	Demonstration and Performance	10 min	C2-017 (pp. 13,14, and 29 to 31)

A-CR-CCP-701/PG-001

TP	Description	Method	Time	Ref
	<p>Notes:</p> <ol style="list-style-type: none"> 1. When properly adjusted, the backpack should leave shoulders and hips free to move. This allows the individual wearing it to stand erect in a normal position and walk at a normal pace. 2. If CF rucksacks are to be used, they should be assessed for proper assembly prior to being given to the cadets. 			

5. **Time**

- a. Introduction/Conclusion: 5 min
- b. Demonstration and Performance: 10 min
- c. Total: 15 min

6. **Substantiation.** The demonstration-performance method was chosen to allow cadets to participate in supervised exploration of practical instructional material. This method provides the instructor the opportunity to introduce the subject matter, demonstrate and explain procedures, and supervise the cadets while they imitate the skill. This method appeals to all learning styles.

7. **References**

- a. C2-004 (ISBN 1-896713-00-9) Tawrell, P. (1996). *Camping and Wilderness Survival: The Ultimate Outdoors Book*. Green Valley, ON: Paul Tawrell.
- b. C2-005 (ISBN 0-393-31334-4) Berger, K. (1995). *Hiking and Backpacking, A Trailside Guide*. New York, NY: Norton and Company, Inc.
- c. C2-009 (ISBN 0-684-85909-2) Harvey, M. (1999). *The National Outdoor Leadership School's Wilderness Guide*. New York, NY: Fireside.
- d. C2-017 (ISBN 0-7627-0476-4) Roberts, H. (1999). *Basic Essentials, Backpacking*. Guilford, CT: The Globe Pequot Press.

8. **Training Aids**

- a. Presentation aids (i.e. whiteboard/flipchart/OHP) appropriate for classroom/training area;
- b. Backpacks (external and internal frames); and
- c. Suitable examples of personal equipment.

9. **Learning Aids**

- a. Backpack; and
- b. Personal equipment.

10. **Test Details.** There is no formal assessment of this EO. Instructors will confirm the cadets' comprehension of the material during the end of lesson check. The instructor will also monitor the cadets during the bivouac FTX, advising/correcting as necessary.

A-CR-CCP-701/PG-001

11. **Remarks.** This lesson should be delivered prior to the bivouac FTX. Instructors are encouraged to arrange for cadets at the unit to have their backpacks checked over for proper packing on the night preceding the bivouac FTX.



ROYAL CANADIAN ARMY CADETS
GREEN STAR
INSTRUCTIONAL GUIDE



SECTION 2

EO M121.02 – TRANSPORT PERSONAL EQUIPMENT

Total Time: 15 min

PREPARATION

PRE-LESSON INSTRUCTIONS

Resources needed for the delivery of this lesson are listed in the lesson specification located at Chapter 4 of the QSP. Specific uses for said resources are identified throughout the Instructional Guide, within the TP for which they are required.

Review the lesson content and become familiar with the material prior to delivering the lesson lesson.

PRE-LESSON ASSIGNMENT

N/A.

APPROACH

The demonstration and performance method was chosen to allow cadets to participate in supervised exploration of practical instructional material. This method provides the instructor the opportunity to introduce the subject matter, demonstrate and explain procedures, and supervise the cadets while they imitate the skill. This method appeals to all learning styles.

INTRODUCTION

REVIEW

N/A.

OBJECTIVES

By the end of this lesson the cadets will be expected to properly wear a backpack.

IMPORTANCE

This lesson will allow cadets to train in the field, and carry their equipment safely and efficiently.

A-CR-CCP-701/PF-001

Teaching Point 1

Explain and Demonstrate How to Properly Wear a Backpack

Time: 10 min

Method: Demonstration and Performance

DONNING A BACKPACK



The instructor should inform the cadets that left-handed people might wish to follow these directions using opposite hands, in order to accommodate the dominant hand.

There are many different ways to pick up and don a backpack. If donning is done incorrectly, a back injury can occur. The following is a step-by-step method considered safe for donning a backpack:

1. unlatch hip belt and loosen both shoulder straps;
2. pick the backpack up with your right hand on the crossbar from which the shoulder straps are suspended and left hand on the right strap lift backpack high enough to rest it on your right knee;
3. slide right arm through the shoulder strap and swing it onto your back;
4. put left arm through the other strap;
5. tighten the hip belt and shoulder straps; and
6. ensure all loose belts or strap ends are tucked in and off you go.



When properly adjusted the backpack should leave shoulders and hips free to move. This allows the individual wearing it to stand erect in a normal position and walk at a normal pace.



- Give cadets the opportunity to practice donning the backpack, as time allows.
- If CF rucksacks are to be used, they should be assessed for proper assembly.

CONFIRMATION OF TEACHING POINT 1

QUESTIONS

- Q1. What should be loosened prior to donning the backpack?
- Q2. When the backpack is harnessed and on the back, what should one ensure is tucked in?
- Q3. When properly adjusted the backpack should leave the *(blank)* and the *(blank)* free to move.

ANTICIPATED ANSWERS

- A1. Unlatch hip belt and loosen both shoulder straps.
- A2. All loose belts or strap ends are tucked in.
- A3. Shoulders and hips.

END OF LESSON CONFIRMATION

The cadets' participation in donning a backpack will serve as the confirmation of this lesson.

CONCLUSION

HOMEWORK/READING/PRACTICE

N/A.

METHOD OF EVALUATION

N/A.

CLOSING STATEMENT

The cadets can now to go into the field and carry their equipment and gear safely and effectively.

INSTRUCTOR NOTES/REMARKS

N/A.

REFERENCES

- C2-004 (ISBN 1-896713-00-9) Tawrell, P. (1996). *Camping and Wilderness Survival: The Ultimate Outdoors Book*. Green Valley, ON: Paul Tawrell.
- C2-005 (ISBN 0-393-31334-4) Berger, K. (1995). *Hiking and Backpacking, a Trail Side Guide*. New York, NY: Norton and Company, Inc.
- C2-009 (ISBN 0-684-85909-2) Harvey, M. (1999). *The National Outdoor Leadership School's Wilderness Guide*. New York, NY: Fireside.
- C2-017 (ISBN 0-7627-0476-4) Roberts, H. (1999). *Basic Essentials, Backpacking*. Guilford, CT: The Globe Pequot Press.

MODIFIED LESSON SPECIFICATIONS AND INSTRUCTIONAL GUIDES – TP 1 OF EO M222.02

A-CR-CCP-702/PG-001

EO M222.02 – DESCRIBE BEARINGS

1. **Performance.** Describe Bearings.
2. **Conditions**
 - a. Given:
 - (1) compass rose;
 - (2) supervision; and
 - (3) assistance as required.
 - b. Denied: N/A.
 - c. Environmental: Suitable classroom facility or training area large enough to accommodate the entire group.
3. **Standard.** In accordance with B-GL-382-005/PT-001, the cadet shall identifying true, grid, and magnetic north.

4. **Teaching Points**

TP	Description	Method	Time	Ref
TP1	Identify and explain the three norths, to include: <ol style="list-style-type: none"> a. true north; b. grid north; and c. magnetic north. 	Interactive Lecture	10 min	A2-041 (pp. 50-51)

5. **Time**
 - a. Introduction/Conclusion: 5 min
 - b. Interactive Lecture: 10 min
 - c. Total: 15 min
6. **Substantiation.** An interactive lecture was chosen for TP1 to present basic material, orient the cadets to bearings, and to generate interest.
7. **References.** A2-041 B-GL-382-005/PT-001 Canadian Forces. (2006). *Maps, Field Sketching, Compasses and the Global Positioning System*. Ottawa, ON: Department of National Defence.
8. **Training Aids**
 - a. Presentation aids (eg, whiteboard/flipchart/OHP) appropriate for classroom/training area;
 - b. Topographical map; and
 - c. Compass rose.
9. **Learning Aids**
 - a. Pencil; and
 - b. Compass rose.

10. **Test Details.** N/A.
11. **Remarks.** N/A.



ROYAL CANADIAN ARMY CADETS

RED STAR

INSTRUCTIONAL GUIDE



SECTION 2

EO M222.02 – DESCRIBE BEARINGS

Total Time: 15 min

PREPARATION

PRE-LESSON INSTRUCTIONS

Resources needed for the delivery of this lesson are listed in the lesson specification located in A-CR-CCP-702/PG-001, Chapter 4. Specific uses for said resources are identified throughout the Instructional Guide within the TP for which they are required.

Review the lesson content and become familiar with the material prior to delivering the lesson.

PRE-LESSON ASSIGNMENT

N/A.

APPROACH

An interactive lecture was chosen for this lesson to present basic material, orient the cadets to bearings, and to generate interest.

INTRODUCTION

REVIEW

N/A.

OBJECTIVES

By the end of this lesson the cadet shall be expected to identify true, grid, and magnetic north.

IMPORTANCE

It is important for cadets to identify and explain the three norths as this may assist them throughout navigation and expedition training.

Teaching Point 1

Identify and Explain the Three Norths

Time: 10 min

Method: Interactive Lecture

In navigation there are three different norths that are used – true north, grid north and magnetic north. Each north varies a small amount from each other and must be known for use in navigation. A diagram representing the three norths can be found in the margin of the map being used.

A-CR-CCP-702/PF-001



Draw Figure 12-2-1 on the board and draw the symbol for each north as it is explained to the cadets.

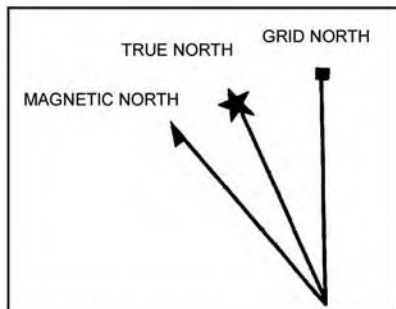

B-GL-382-005/PT-001 (p. 51)

Figure 12-2-1 Three Norths

True North. True north is located at the top of the earth where the geographic North Pole is found, and is where all lines of longitude meet. In the diagram on the map, true north is represented by a star (Polaris).

Grid North. Grid north is the north indicated by the grid lines (eastings) on a topographical map. The easting lines run parallel to each other and will never meet at the North Pole; because of this, grid north points off slightly from true north. In the diagram on the map, grid north is represented by a square (map grid).

Magnetic North. Magnetic north is the direction in which the compass needle points. This direction is to the magnetic pole which is located in the Canadian arctic and is slightly different from true north (North Pole). In the diagram on the map, magnetic north is represented by a needle (compass).

CONFIRMATION OF TEACHING POINT 1

QUESTIONS

- Q1. What symbol is used to represent true north?
- Q2. What symbol is used to represent grid north?
- Q3. What symbol is used to represent magnetic north?

ANTICIPATED ANSWERS

- A1. A star, as in Polaris.
- A2. A square, as in a grid square.
- A3. A needle, as in a compass.

END OF LESSON CONFIRMATION

The cadets identification of the three norths will serve as the confirmation of this lesson.

A-CR-CCP-702/PF-001

CONCLUSION

HOMEWORK/READING/PRACTICE

N/A.

METHOD OF EVALUATION

N/A.

CLOSING STATEMENT

Being able to identify the three norths is an important aspect of navigation training, as it allows cadets to identify direction when travelling from one point to another.

INSTRUCTOR NOTES/REMARKS

N/A.

REFERENCES

A2-041 B-GL-382-005/PT-001 Canadian Forces. (2006). *Maps, Field Sketching, Compasses and the Global Positioning System*. Ottawa, ON: Department of National Defence.

THIS PAGE INTENTIONALLY LEFT BLANK

INSTRUCTIONAL TECHNIQUES – ASSESSMENT FORM

Cadet's Name: _____

Platoon: _____

Lesson Topic: _____

Criteria	Comments	Incomplete	Completed With Difficulty	Completed Without Difficulty
PREPARATION				
Selected a lesson location.				
Set up the lesson location.				
Used a lesson plan.				
Selected an appropriate method(s) of instruction.				
Reviewed previous lesson material.				
INTRODUCTION				
Stated what the cadets will learn.				
Stated why it is important.				
Described where the knowledge/skill will be applied.				
BODY				
Applied the principles of instruction. (interest, comprehension, emphasis, participation, accomplishment and confirmation)				
Selected an appropriate instructional aid(s).				

Criteria	Comments	Incomplete	Completed With Difficulty	Completed Without Difficulty
END OF LESSON CONFIRMATION				
Used questions/activity to confirm knowledge or skills.				
CONCLUSION				
Summarized the lesson.				
Re-motivated the cadets.				
Described the next lesson.				
EFFECTIVE-SPEAKING TECHNIQUES				
Applied the elements of voice control. (pitch, tone, volume, speed, pause and articulation)				
Used appropriate body language.				
Maintaining appropriate dress and deportment.				
QUESTIONING TECHNIQUES				
Choose appropriate types of questions.				
Applied the questioning sequence. (pose, pause, pounce, ponder and praise)				
FEEDBACK				

 Assessor's Signature

 Date

 Cadet's Signature

LIST OF TOPICS

1. Your personal involvement within the cadet corps.
2. One fun event in which you took part at a Cadet Summer Training Centre.
3. One subject or topic area you would like to see added to/expanded on in the current training program.
4. One goal you have set or attained while in cadets.
5. Where you see yourself within the corps in the future.
6. One fun event in which you took part with the corps.
7. Your first night as a cadet.
8. Your first trip with the corps.
9. Your first visit to the expedition centre.
10. Why you joined cadets.

THIS PAGE INTENTIONALLY LEFT BLANK

VERBAL PRESENTATION – FEEDBACK FORM

Name: _____

Date: _____

Length: **1 min**

Start: _____

End: _____

Total: _____

Criteria	Comments	Yes	No
Introduction			
Body			
Conclusion			
Voice			
Body Language			
Dress & Deportment			
Presentation Aid(s)			
Comments:			
Strengths		Areas for Improvement	

Instructor's Signature

Cadet's Signature

THIS PAGE INTENTIONALLY LEFT BLANK

THE LESSON PLAN

The lesson plan is a way for the instructor to organize the lesson and summarize information included in the lesson specification, the IG and their personal ideas. Lesson plans provide a set of detailed directions for delivering one or more periods of instruction.

The lesson plan is arranged in this specific order:

Part	Purpose
1. Introduction	Builds the cadets' interest and motivation.
2. Body	Presents and explains each TP.
3. End of Lesson Confirmation	Confirms cadets' comprehension of the lesson.
4. Conclusion	Summarizes key points and identifies future lessons.

Introduction

The introduction is the instructor's first verbal interaction with the cadets. It should capture the cadets' interest. The following should be included in the introduction of a lesson plan:

- **What.** A description of what the cadets will be expected to accomplish at the end of the lesson.
- **Why.** A description of how and where the lesson fits into the Cadet Program.
- **Where.** A description of why it is important for the cadets to achieve the objectives.



Read the "Objective" and "Importance" paragraphs in the IG for help in writing the introduction of the lesson plan.

Body

The body of the lesson plan is where the content is presented, explained and supported. Each TP directs the instructor and the cadets.

Each TP in the lesson includes:

- **Introduction.** Briefly introduce the content to be taught during the TP.
- **Teaching Method.** Identifies which teaching method has been chosen for the given TP.
- **Lesson Content.** Presents the lesson content in a clear and logical order, from easy to difficult or known to unknown.
- **Confirmation.** Confirmation of the TP may be oral questions, games, role-play or an in-class or practical activity. Instructional guides offer suggestions on how to confirm TPs. Instructors may choose to use those confirmation suggestions or develop their own.

End of Lesson Confirmation

The lesson plan should outline procedures to be used to confirm the learning of the TP. End of lesson confirmations are carried out to ensure that the cadets have understood the whole lesson and that any weaknesses in performance are identified so they may be corrected.

Confirmation activities are based on the lesson objectives. The end of lesson confirmation may be oral questions, games, role-play or an in-class or practical activity. IGs offer suggestions for how to conduct end of lesson confirmations. Instructors may choose to use those confirmation suggestions or develop their own.

Conclusion

The conclusion of a lesson allows the instructor to give a summary of key points and link them to the coming lessons and their practical use.

- **A Summary of Important Points and Any Weak Areas.** The summary reviews the main TPs. The depth of the summary will be determined by the lesson objectives and the results of the cadets' end of lesson confirmation/test. If the cadets achieved the objectives successfully, the summary may be brief. If they experienced some difficulties, the instructor should summarize them here and indicate how the issue will be addressed.
- **Re-Motivation Statement.** The re-motivation statement restates the importance of the lesson (the "why") and re-motivates the cadets. The instructor should also take this time to give an overview of the next lesson and any precautions the cadets should be aware of when using the knowledge they have gained in a practical setting.



Read the "Closing Statement" paragraph in the IG for help in writing the conclusion of the lesson plan.

PLAN A DRILL LESSON CHECKLIST

PREPARATION	NOTES
<p>Have you:</p> <ul style="list-style-type: none"> <input type="checkbox"/> Selected an appropriate squad formation? <input type="checkbox"/> Written a lesson plan? 	
INTRODUCTION	
<p>Does your introduction:</p> <ul style="list-style-type: none"> <input type="checkbox"/> Review previous lesson material? <input type="checkbox"/> State what the cadets will learn? <input type="checkbox"/> Describe why the movement is important to learn? <input type="checkbox"/> Describe where and when the movement can be used? <input type="checkbox"/> Describe how the cadets will be assessed? 	
BODY	
<p>Does the body of your lesson:</p> <ul style="list-style-type: none"> <input type="checkbox"/> Demonstrate the complete movement with the instructor calling the time? <input type="checkbox"/> Explain the movement? <input type="checkbox"/> Demonstrate and explain the first part of the movement (Squad 1)? <input type="checkbox"/> Provide time for the squad to ask questions? <input type="checkbox"/> Permit practice of the first part of the movement (collectively, individually, collectively)? <input type="checkbox"/> Teach the second and each subsequent movement following the sequence described above? <input type="checkbox"/> Permit practice of the complete movement with: <ul style="list-style-type: none"> <input type="checkbox"/> the instructor calling the time; <input type="checkbox"/> the cadets calling the time; and <input type="checkbox"/> the cadets judging the time? <input type="checkbox"/> Confirm each TP? <input type="checkbox"/> Include two complete demonstrations? 	

END OF LESSON CONFIRMATION	
<input type="checkbox"/>	Did you conduct an end of lesson confirmation?
CONCLUSION	
Does your conclusion:	
<input type="checkbox"/>	Restate the movement taught and where or when it will be used?
<input type="checkbox"/>	Re-motivate the cadets by:
<input type="checkbox"/>	comment on the cadets' progress; and
<input type="checkbox"/>	re-state why the drill movement just learned is important?
<input type="checkbox"/>	Describe the next lesson?

LIST OF APPROVED 15-MINUTE DRILL TOPICS

Teach the movement of attention from stand at ease and stand at ease from attention, (M108.01 [Adopt the Positions of Attention, Stand at Ease and Stand Easy], A-CR-CCP-701/PG-001, Chapter 4, Section 8, A-CR-CCP-701/PF-001, Chapter 8, Section 1).

Teach the movement of stand easy from stand at ease, and stand at ease from stand easy, (M108.01, A-CR-CCP-701/PG-001, Chapter 4, Section 8, A-CR-CCP-701/PF-001, Chapter 8, Section 1).

Teach a salute to the front, (M108.02 [Execute a Salute at the Halt Without Arms], A-CR-CCP-701/PG-001, Chapter 4, Section 8, A-CR-CCP-701/PF-001, Chapter 8, Section 2).

Teach a salute to the right (left), (M108.02 [Execute a Salute at the Halt Without Arms], A-CR-CCP-701/PG-001, Chapter 4, Section 8, A-CR-CCP-701/PF-001, Chapter 8, Section 2).

Teach the right turn at the halt, (M108.03 [Execute Turns at the Halt], A-CR-CCP-701/PG-001, Chapter 4, Section 8, A-CR-CCP-701/PF-001, Chapter 8, Section 3).

Teach the left turn at the halt, (M108.03 [Execute Turns at the Halt], A-CR-CCP-701/PG-001, Chapter 4, Section 8, A-CR-CCP-701/PF-001, Chapter 8, Section 3).

Teach the about turn at the halt, (M108.03 [Execute Turns at the Halt], A-CR-CCP-701/PG-001, Chapter 4, Section 8, A-CR-CCP-701/PF-001, Chapter 8, Section 3).

THIS PAGE INTENTIONALLY LEFT BLANK

MODIFIED LESSON SPECIFICATIONS AND INSTRUCTIONAL GUIDES – TP 1 AND 2 OF EO M108.01

A-CR-CCP-701/PG-001

EO M108.01 – ADOPT THE POSITIONS OF ATTENTION, STAND AT EASE, AND STAND EASY

1. **Performance.** Adopt the Positions of Attention, Stand at Ease, and Stand Easy.
2. **Conditions**
 - a. Given:
 - (1) words of command;
 - (2) supervision; and
 - (3) assistance as required.
 - b. Denied: N/A.
 - c. Environmental: A drill hall or, in favourable weather, an outdoor parade square.
3. **Standard.** In accordance with A-PD-201-000/PT-000, the cadet shall perform the following individual drill movements:
 - a. attention from stand at ease; and
 - b. stand at ease from attention.

4. **Teaching Points**

TP	Description	Method	Time	Ref
TP1	Explain and demonstrate the movement of attention from stand at ease and allow cadets to practice.	Demonstration and Performance	5 min	A0-002 (pp. 2-2 to 2-8)
TP2	Explain and demonstrate the movement of stand at ease from attention and allow cadets to practice.	Demonstration and Performance	5 min	A0-002 (pp. 2-2 to 2-8)

5. **Time**
 - a. Introduction/Conclusion: 5 min
 - b. Demonstration and Performance: 10 min
 - c. Total: 15 min
6. **Substantiation.** The demonstration-performance method was chosen to allow cadets to participate in supervised exploration of practical instructional material. This method provides the instructor the opportunity to introduce the subject matter, demonstrate and explain procedures, and supervise the cadets while they imitate the skill. This method appeals to all learning styles.
7. **References.** A0-002 A-PD-201-000/PT-000 DHH 3-2. (2001). *The Canadian Forces Manual of Drill and Ceremonial*. Ottawa, ON: The Department of National Defence.
8. **Training Aids.** Assistant instructors as required.
9. **Learning Aids.** N/A.

A-CR-CCP-701/PG-001

10. **Test Details.** There is no formal assessment of this EO. Instructors will confirm the cadets' ability to perform the movements during the end of lesson check, and ongoing feedback will be provided during future drill practices, weekly parade nights, and ceremonial parades.
11. **Remarks.** N/A.

A-CR-CCP-701/PF-001



**COMMON TRAINING
GREEN STAR
INSTRUCTIONAL GUIDE**



SECTION 1

EO M108.01 – ADOPT THE POSITIONS OF ATTENTION, STAND AT EASE AND STAND EASY

Total Time: 15 min

PREPARATION

PRE-LESSON INSTRUCTIONS

A complete list of resources needed for the instruction of this EO is located at Chapter 4 of the QSP. Specific uses for said stores are identified throughout the Instructional Guide, within the teaching point for which they are required.

Prior to instructing this lesson the instructor shall:

- review the lesson content, and become familiar with the material; and
- select the most effective squad formation for the lesson being taught. A squad may be in a single rank, hollow square or semi-circle for elementary drill instruction. (Note: All cadets **must** be able to fully observe all demonstrations and explanations.)

PRE-LESSON ASSIGNMENT

N/A.

APPROACH

This lesson will be presented using the demonstration and performance method. The demonstration and performance method was chosen to allow cadets to participate in supervised exploration of practical instructional material. This method provides the instructor the opportunity to introduce the subject matter, demonstrate and explain procedures, and supervise the cadets while they imitate the skill. This method appeals to all learning styles.



The instructor shall develop and use a vocabulary of short, concise words to impress on the squad that the movements must be performed smartly. For example, the words "crack", "drive", "seize" and "grasp" suggest the degree of smartness required. Profanity or personal sarcasm shall never be used.

INTRODUCTION

REVIEW

N/A.

A-CR-CCP-701/PF-001

OBJECTIVES

By the end of this lesson the cadet shall be expected to adopt the positions of attention and stand at ease.

IMPORTANCE

As members of the Canadian Cadet Movement (CCM) cadets will be required to perform drill movements at a competent level, developing sharpness, esprit de corps, physical coordination, and alertness. These movements will be executed with ease and without hesitation. Ensuring that the cadets efficiently move together as one will promote discipline, alertness, precision, pride, steadiness, and cohesion. This develops the basis of teamwork that the CCM depends on.

Teaching Point 1

Adopting the Position of Attention From Stand at Ease

Time: 5 min

Method: Demonstration and Performance



Instructors are reminded that they are to present the example with regards to drill, from the moment they step onto the parade square. Proper drill movements, combined with a professional demeanour, are of paramount importance, and must be exemplified throughout the period of instruction.

DEMONSTRATE THE COMPLETE MOVEMENT WITH TIMING

The instructor shall provide a complete demonstration of the drill movement, with timing. A practiced assistant instructor may carry out this demonstration.

The demonstration shall be provided from various vantage points, as required.

DEMONSTRATE FIRST PART OF MOVEMENT (FIRST NUMBER)



For ease of instruction, drill commands have been broken down into individual movements, or numbers. The instructor(s) shall demonstrate and explain each number.

In order to adopt the position of attention from stand at ease, the cadet shall:

On the command ATTENTION BY NUMBERS, SQUAD – ONE, bend the left knee and shift the balance to the right foot.

PRACTICE THE SQUAD ON THE FIRST MOVEMENT

Practice the squad on the first movement collectively, individually and collectively.

DEMONSTRATE AND EXPLAIN THE SECOND PART OF THE MOVEMENT

On the command SQUAD – TWO:

1. straighten the left leg in double time, place the foot smartly on the ground, toe touching first, followed by the heel, and with heels aligned; and
2. simultaneously, with a quick motion, bring the arms and hands to the position of attention.

A-CR-CCP-701/PF-001

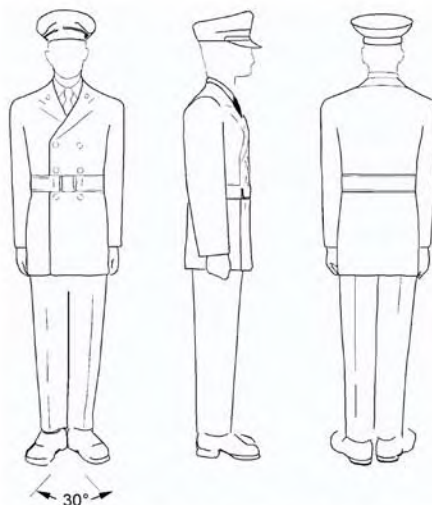

A-PD-201-000/PT-000, *The Canadian Forces Manual of Drill and Ceremonial, 2001*

Figure 8-1-1 The Position of Attention



A-PD-201-000/PT-000, *The Canadian Forces Manual of Drill and Ceremonial, 2001*

Figure 8-1-2 Fists at Position of Attention



Constant checking and correcting of all faults is essential. Faults shall be corrected immediately after they occur.

GIVE TWO COMPLETE AND FINAL DEMONSTRATIONS

On the command ATTEN – TION, combine the two movements. The timing is called as “one.”

The instructor(s) shall provide a full demonstration and allow time for practice.

CONFIRMATION OF TEACHING POINT 1

Cadet will adopt the position of attention as a squad.

A-CR-CCP-701/PF-001

Teaching Point 2

Adopting the Position of Stand at Ease From Attention

Time: 5 min

Method: Demonstration and Performance

DEMONSTRATE THE COMPLETE MOVEMENT WITH TIMING

The position of standing at ease is an intermediate position between attention and standing easy. It allows no relaxation, but can be maintained without strain for a longer time than the position of attention.

DEMONSTRATE FIRST PART OF MOVEMENT (FIRST NUMBER)



For ease of instruction, drill commands have been broken down into individual movements, or numbers. The instructor(s) shall demonstrate and explain each number.

On the command STAND AT EASE BY NUMBERS, SQUAD – ONE, the cadet shall bend the left knee.



A-PD-201-000/PT-000, The Canadian Forces Manual of Drill and Ceremonial, 2001

Figure 8-1-3 Squad One – Stand at Ease

PRACTICE THE SQUAD ON THE FIRST MOVEMENT

Practice the squad on the first movement collectively, individually and collectively.

DEMONSTRATE AND EXPLAIN THE SECOND PART OF THE MOVEMENT (SECOND NUMBER)

On the command SQUAD – TWO, the cadet shall:

1. carry the left foot to the left, straightening it in double time, and place it smartly flat on the ground with the inside of the heels 25 cm apart;
2. simultaneously, with a quick motion, bring the arms behind the back, stretched to their full extent, and place the back of the right hand in the palm of the left, with thumbs crossed right over left, the fingers together and extended; and
3. balance the body with the weight evenly distributed on both feet.

A-CR-CCP-701/PF-001

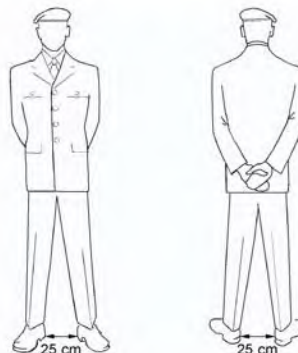

A-PD-201-000/PT-000, *The Canadian Forces Manual of Drill and Ceremonial, 2001*

Figure 8-1-4 The Position of Stand at Ease

PRACTICE THE SQUAD ON THE SECOND MOVEMENT

Practice the squad on the second movement collectively, individually and collectively.

GIVE TWO COMPLETE AND FINAL DEMONSTRATIONS

On the command STAND AT – EASE, combine the two movements. The timing is "one."

The instructor(s) shall provide a full demonstration and allow time for practice



Constant checking and correcting of all faults is essential. Faults shall be corrected immediately after they occur.

CONFIRMATION OF TEACHING POINT 2

Cadets will adopt the position of stand at ease as a squad.

END OF LESSON CONFIRMATION

The confirmation for this lesson should consist of the cadets, as a squad, practicing the positions of attention, stand at ease and stand easy, and should emphasize movements that cadets showed difficulty with during the class.

Practice the complete movement, with the:

- **instructor** calling the time;
- **squad** calling the time; and
- squad **judging** the time.

A-CR-CCP-701/PF-001

CONCLUSION

HOMEWORK/READING/PRACTICE

Drill movements are skills that must be practiced individually, in order to make the cadet more proficient as a member of a unit. Cadets are encouraged to practice the movements, as opportunities are made available. Ongoing feedback will be provided, and should be heeded during any drill practice.

METHOD OF EVALUATION

In accordance with A-PD-201-000/PT-000, *The Canadian Forces Manual of Drill and Ceremonial*, the cadet shall participate in an Annual Ceremonial Review (ACR) parade. This movement will be used in preparation for, and in the execution of, the ACR parade.

CLOSING STATEMENT

The hallmarks of cadet drill are efficiency, precision, and dignity. These qualities are developed through self-discipline and practice. They lead to unit pride and cohesion. Good drill that is well rehearsed, closely supervised and precise, is an exercise in obedience and alertness. It sets the standard for the execution of any duty, both for the individual and the unit, and builds a sense of confidence between commander and subordinate that is essential to high morale. The personal qualities developed on the parade ground must be maintained in all aspects of life.

INSTRUCTOR NOTES/REMARKS

N/A.

REFERENCES

A0-002 A-PD-201-000/PT-000 DHH 3-2. (2001). *The Canadian Forces Manual of Drill and Ceremonial*. Ottawa, ON: The Department of National Defence.

MODIFIED LESSON SPECIFICATIONS AND INSTRUCTIONAL GUIDES – TP 1 AND 2 OF EO M108.01

A-CR-CCP-701/PG-001

EO M108.01 – ADOPT THE POSITIONS OF ATTENTION, STAND AT EASE, AND STAND EASY

1. **Performance.** Adopt the Positions of Attention, Stand at Ease, and Stand Easy.
2. **Conditions**
 - a. Given:
 - (1) words of command;
 - (2) supervision; and
 - (3) assistance as required.
 - b. Denied: N/A.
 - c. Environmental: A drill hall or, in favourable weather, an outdoor parade square.
3. **Standard.** In accordance with A-PD-201-000/PT-000, the cadet shall perform the following individual drill movements:
 - a. stand easy from stand at ease; and
 - b. stand at ease from stand easy.

4. **Teaching Points**

TP	Description	Method	Time	Ref
TP1	Explain and demonstrate the movement of stand easy from stand at ease and allow cadets to practice.	Demonstration and Performance	5 min	A0-002 (pp. 2-2 to 2-8)
TP2	Explain and demonstrate the movement of stand at ease from stand easy and allow cadets to practice.	Demonstration and Performance	5 min	A0-002 (pp. 2-2 to 2-8)

5. **Time**
 - a. Introduction/Conclusion: 5 min
 - b. Demonstration and Performance: 10 min
 - c. Total: 15 min
6. **Substantiation.** The demonstration-performance method was chosen to allow cadets to participate in supervised exploration of practical instructional material. This method provides the instructor the opportunity to introduce the subject matter, demonstrate and explain procedures, and supervise the cadets while they imitate the skill. This method appeals to all learning styles.
7. **References.** A0-002 A-PD-201-000/PT-000 DHH 3-2. (2001). *The Canadian Forces Manual of Drill and Ceremonial*. Ottawa, ON: The Department of National Defence.
8. **Training Aids.** Assistant instructors as required.
9. **Learning Aids.** N/A.

A-CR-CCP-701/PG-001

10. **Test Details.** There is no formal assessment of this EO. Instructors will confirm the cadets' ability to perform the movements during the end of lesson check, and ongoing feedback will be provided during future drill practices, weekly parade nights, and ceremonial parades.
11. **Remarks.** N/A.

A-CR-CCP-701/PF-001



**COMMON TRAINING
GREEN STAR
INSTRUCTIONAL GUIDE**



SECTION 1

EO M108.01 – ADOPT THE POSITIONS OF ATTENTION, STAND AT EASE AND STAND EASY

Total Time: 15 min

PREPARATION

PRE-LESSON INSTRUCTIONS

A complete list of resources needed for the instruction of this EO is located at Chapter 4 of the QSP. Specific uses for said stores are identified throughout the Instructional Guide, within the teaching point for which they are required.

Prior to instructing this lesson the instructor shall:

- review the lesson content, and become familiar with the material; and
- select the most effective squad formation for the lesson being taught. A squad may be in a single rank, hollow square or semi-circle for elementary drill instruction. (Note: All cadets **must** be able to fully observe all demonstrations and explanations.)

PRE-LESSON ASSIGNMENT

N/A.

APPROACH

This lesson will be presented using the demonstration and performance method. The demonstration and performance method was chosen to allow cadets to participate in supervised exploration of practical instructional material. This method provides the instructor the opportunity to introduce the subject matter, demonstrate and explain procedures, and supervise the cadets while they imitate the skill. This method appeals to all learning styles.



The instructor shall develop and use a vocabulary of short, concise words to impress on the squad that the movements must be performed smartly. For example, the words "crack", "drive", "seize" and "grasp" suggest the degree of smartness required. Profanity or personal sarcasm shall never be used.

INTRODUCTION

REVIEW

N/A.

A-CR-CCP-701/PF-001

OBJECTIVES

By the end of this lesson the cadet shall be expected to adopt the positions of stand easy and stand at ease.

IMPORTANCE

As members of the Canadian Cadet Movement (CCM) cadets will be required to perform drill movements at a competent level, developing sharpness, esprit de corps, physical coordination, and alertness. These movements will be executed with ease and without hesitation. Ensuring that the cadets efficiently move together as one will promote discipline, alertness, precision, pride, steadiness, and cohesion. This develops the basis of teamwork that the CCM depends on.

Teaching Point 1

Adopting the Position of Stand Easy

Time: 5 min

Method: Demonstration and Performance

DEMONSTRATE THE COMPLETE MOVEMENT WITH TIMING



Instructors are reminded that they are to present the example with regards to drill, from the moment they step onto the parade square. Proper drill movements, combined with a professional demeanour, are of paramount importance, and must be exemplified throughout the period of instruction.

DEMONSTRATE THE COMPLETE MOVEMENT WITH TIMING

The instructor shall provide a complete demonstration of the drill movement, with timing. A practiced assistant instructor may carry out this demonstration.

The demonstration shall be provided from various vantage points, as required.

The position of stand easy is ordered when it is desirable to permit cadets to relax. This command is only given when the squad is in the position of stand at ease.

On the command STAND – EASY, the cadet shall:

1. close the hands and bring the arms to the position of attention: and
2. relax.

A-CR-CCP-701/PF-001

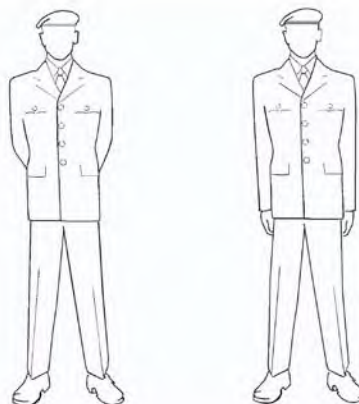

A-PD-201-000/PT-000, *The Canadian Forces Manual of Drill and Ceremonial, 2001*

Figure 8-1-1 Stand Easy From Stand at Ease



When standing easy, the cadet may, with permission, move all but the feet and adjust clothing and equipment, but shall not talk.

PRACTICE THE COMPLETE MOVEMENT WITH TIMING

Practice the squad on the first movement collectively, individually and collectively.

GIVE TWO COMPLETE AND FINAL DEMONSTRATIONS

Combine the preceding movements with timing. The instructor(s) shall provide a full demonstration and allow time for practice.



Constant checking and correcting of all faults is essential. Faults shall be corrected immediately after they occur.

CONFIRMATION OF TEACHING POINT 1

Cadets will adopt the position of stand easy as a squad.

Teaching Point 2

Adopting the Position of Stand at Ease from Standing Easy

Time: 5 min

Method: Demonstration and Performance

DEMONSTRATE THE COMPLETE MOVEMENT WITH TIMING

The instructor shall provide a complete demonstration of the drill movement, with timing. A practiced assistant instructor may carry out this demonstration.

A-CR-CCP-701/PF-001

The demonstration shall be provided from various vantage points, as required.

In order to adopt the position of stand at ease from easy the cadet shall, on the cautionary command SQUAD (or formation title), assume the position of stand at ease.

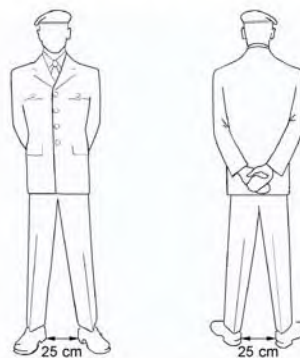

Figure 8-1-2 The Position of Stand at Ease



This TP is best taught as a group practice to ensure adherence to timings and togetherness of the squad.



Constant checking and correcting of all faults is essential. Faults shall be corrected immediately after they occur.

CONFIRMATION OF TEACHING POINT 2

Cadets will adopt the position of stand at ease as a squad.

END OF LESSON CONFIRMATION

The confirmation for this lesson should consist of the cadets, as a squad, practicing the positions of attention, stand at ease and stand easy, and should emphasize movements that cadets showed difficulty with during the class.

Practice the complete movement, with the:

- **instructor** calling the time;
- **squad** calling the time; and
- squad **judging** the time.

A-CR-CCP-701/PF-001

CONCLUSION

HOMEWORK/READING/PRACTICE

Drill movements are skills that must be practiced individually, in order to make the cadet more proficient as a member of a unit. Cadets are encouraged to practice the movements, as opportunities are made available. Ongoing feedback will be provided, and should be heeded during any drill practice.

METHOD OF EVALUATION

In accordance with A-PD-201-000/PT-000, *The Canadian Forces Manual of Drill and Ceremonial*, the cadet shall participate in an Annual Ceremonial Review (ACR) parade. This movement will be used in preparation for, and in the execution of, the ACR parade.

CLOSING STATEMENT

The hallmarks of cadet drill are efficiency, precision, and dignity. These qualities are developed through self-discipline and practice. They lead to unit pride and cohesion. Good drill that is well rehearsed, closely supervised and precise, is an exercise in obedience and alertness. It sets the standard for the execution of any duty, both for the individual and the unit, and builds a sense of confidence between commander and subordinate that is essential to high morale. The personal qualities developed on the parade ground must be maintained in all aspects of life.

INSTRUCTOR NOTES/REMARKS

N/A.

REFERENCES

A0-002 A-PD-201-000/PT-000 DHH 3-2. (2001). *The Canadian Forces Manual of Drill and Ceremonial*. Ottawa, ON: The Department of National Defence.

THIS PAGE INTENTIONALLY LEFT BLANK

MODIFIED LESSON SPECIFICATIONS AND INSTRUCTIONAL GUIDES – TP 1 OF EO M108.02

A-CR-CCP-701/PG-001

EO M108.02 – EXECUTE A SALUTE AT THE HALT WITHOUT ARMS

1. **Performance.** Execute a Salute at the Halt Without Arms.
2. **Conditions**
 - a. Given:
 - (1) words of command;
 - (2) supervision; and
 - (3) assistance as required.
 - b. Denied: N/A.
 - c. Environmental: A drill hall or, in favourable weather, an outdoor parade square.
3. **Standard.** In accordance with A-PD-201-000/PT-000, the cadet shall execute salutes at the halt without arms, to the front.

4. **Teaching Points**

TP	Description	Method	Time	Ref
TP1	Explain and demonstrate saluting to the front at the halt and allow cadets to practice.	Demonstration and Performance	10 min	A0-002 (pp. 2-10 to 2-12)

5. **Time**
 - a. Introduction/Conclusion: 5 min
 - b. Demonstration and Performance: 10 min
 - c. Total: 15 min
6. **Substantiation.** The demonstration-performance method was chosen to allow cadets to participate in supervised exploration of practical instructional material. This method provides the instructor the opportunity to introduce the subject matter, demonstrate and explain procedures, and supervise the cadets while they imitate the skill. This method appeals to all learning styles.
7. **References.** A0-002 A-PD-201-000/PT-000 DHH 3-2. (2001). *The Canadian Forces Manual of Drill and Ceremonial*. Ottawa, ON: The Department of National Defence.
8. **Training Aids.** Assistant instructors as required.
9. **Learning Aids.** N/A.
10. **Test Details.** There is no formal assessment of this EO. Instructors will confirm the cadets' ability to perform the movements during the end of lesson check, and ongoing feedback will be provided during future drill practices, weekly parade nights, and ceremonial parades.
11. **Remarks.** N/A.



COMMON TRAINING
GREEN STAR
INSTRUCTIONAL GUIDE



SECTION 2

EO M108.02 – EXECUTE A SALUTE AT THE HALT WITHOUT ARMS

Total Time: 15 min

PREPARATION

PRE-LESSON INSTRUCTIONS

A complete list of resources needed for the instruction of this EO is located at Chapter 4 of the QSP. Specific uses for said stores are identified throughout the Instructional Guide, within the teaching point for which they are required.

Prior to instructing this lesson the instructor shall:

- review the lesson content, and become familiar with the material; and
- select the most effective squad formation for the lesson being taught. A squad may be in a single rank, hollow square or semi-circle for elementary drill instruction. (Note: All cadets **must** be able to fully observe all demonstrations and explanations.)

PRE-LESSON ASSIGNMENT

N/A.

APPROACH

This lesson will be presented using the demonstration and performance method. The demonstration and performance method was chosen to allow cadets to participate in supervised exploration of practical instructional material. This method provides the instructor the opportunity to introduce the subject matter, demonstrate and explain procedures, and supervise the cadets while they imitate the skill. This method appeals to all learning styles.



The instructor shall develop and use a vocabulary of short, concise words to impress on the squad that the movements must be performed smartly. For example, the words “crack”, “drive”, “seize” and “grasp” suggest the degree of smartness required. Profanity or personal sarcasm shall never be used.

INTRODUCTION

REVIEW

N/A.

A-CR-CCP-701/PF-001

OBJECTIVES

By the end of this lesson the cadet shall be expected to execute a salute at the halt without arms.

IMPORTANCE

As members of the Canadian Cadet Organization (CCO) cadets will be required to perform drill movements at a competent level, developing sharpness, esprit de corps, physical coordination, and alertness. These movements will be executed with ease and without hesitation. Ensuring that the cadets efficiently move together as one will promote discipline, alertness, precision, pride, steadiness, and cohesion. This develops the basis of teamwork that the CCO depends on.

Teaching Point 1

Execute a Salute to the Front

Time: 10 min

Method: Demonstration and Performance

DEMONSTRATE THE COMPLETE MOVEMENT WITH TIMING



Instructors are reminded that they are to present the example with regards to drill, from the moment they step onto the parade square. Proper drill movements, combined with a professional demeanour, are of paramount importance, and must be exemplified throughout the period of instruction.

The instructor shall provide a complete demonstration of the drill movement, with timing. A practiced assistant instructor may carry out this demonstration.

The demonstration shall be provided from various vantage points, as required.

The salute is given with the right hand. When physical incapacity or carrying of articles makes a salute with the right hand impracticable, compliments will be paid by turning the head and eyes to the left or right or standing to attention, as appropriate (see also A-PD-201-000/PT-000, Chapter 1, Section 2).

DEMONSTRATE FIRST PART OF MOVEMENT (FIRST NUMBER)



For ease of instruction, drill commands have been broken down into individual movements, or numbers. The instructor(s) shall demonstrate and explain each number.

On the command TO THE FRONT SALUTE BY NUMBERS, SQUAD – ONE, the cadet shall:

1. bend the right elbow and open the palm of the right hand as it passes the shoulder; and
2. force the right hand by its shortest route to the front of the headdress so that the:
 - a. palm of the hand is facing down;
 - b. thumb and fingers are fully extended and close together;
 - c. tip of the second finger is in line with the outside of the right eyebrow and touching the outside edge of the headdress or arm of glasses, if worn;
 - d. hand, wrist and forearm are in a straight line and at a 45-degree angle to the upper arm;
 - e. elbow is in line with the shoulders; and

- f. upper arm is parallel to the ground.

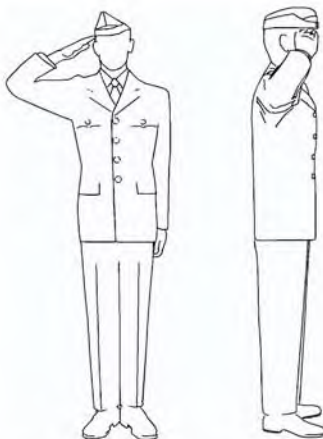

A-PD-201-000/PT-000, The Canadian Forces Manual of Drill and Ceremonial, 2001

Figure 8-2-1 Saluting to the Front Without Arms

PRACTICE THE SQUAD ON THE FIRST MOVEMENT

Practice the squad on the first movement collectively, individually and collectively.



Constant checking and correcting of all faults is essential. Faults shall be corrected immediately after they occur.

DEMONSTRATE AND EXPLAIN THE SECOND PART OF THE MOVEMENT

On the command SQUAD – TWO, the hand is:

1. brought sharply to the position of attention by the shortest route, without slapping the thigh; and
2. closed after the forearm is lowered below shoulder level.

PRACTICE THE SQUAD ON THE SECOND MOVEMENT

Practice the squad on the second movement collectively, individually and collectively.

GIVE TWO COMPLETE AND FINAL DEMONSTRATIONS

On the command TO THE FRONT – SALUTE, the two movements are combined. The standard pause shall be observed between movements.

The instructor(s) shall provide a full demonstration and allow time for practice.

Note: When wearing headdress, other than a cap with a peak, the second finger is 2 cm above and in line with the outer tip of the right eyebrow.

A-CR-CCP-701/PF-001



Standard Pause: The standard pause between each movement is two beats in quick time. For example, on the command MOVE TO THE RIGHT IN FILE, RIGHT – TURN, the squad:

1. executes the first movement of the turn on the executive order and simultaneously calls out "ONE";
2. after completing the first movement, calls "TWO", "THREE" while observing the standard pause; and
3. when executing the final movement, calls out "ONE".

CONFIRMATION OF TEACHING POINT 1

Cadets will execute salutes to the front as a squad.

END OF LESSON CONFIRMATION

The cadets' participation in TP1 will serve as the confirmation of this lesson.

CONCLUSION

HOMEWORK/READING/PRACTICE

N/A.

METHOD OF EVALUATION

In accordance with A-PD-201-000/PT-000, *The Canadian Forces Manual of Drill and Ceremonial*, the cadet shall participate in an Annual Ceremonial Review (ACR) parade. This movement will be used in preparation for, and execution of, the ACR parade.

CLOSING STATEMENT

The hallmarks of cadet drill are efficiency, precision, and dignity. These qualities are developed through self-discipline and practice. They lead to unit pride and cohesion. Good drill, that is well rehearsed, closely supervised and precise, is an exercise in obedience and alertness. It sets the standard for the execution of any duty, both for the individual and the unit, and builds a sense of confidence between commander and subordinate that is essential to high morale. The personal qualities developed on the parade ground must be maintained in all aspects of life.

INSTRUCTOR NOTES/REMARKS

N/A.

REFERENCES

A0-002 A-PD-201-000/PT-000 DHH 3-2. (2001). *The Canadian Forces Manual of Drill and Ceremonial*. Ottawa, ON: The Department of National Defence.

THIS PAGE INTENTIONALLY LEFT BLANK

MODIFIED LESSON SPECIFICATIONS AND INSTRUCTIONAL GUIDES – TP 1 OF EO M108.02

A-CR-CCP-701/PG-001

EO M108.02 – EXECUTE A SALUTE AT THE HALT WITHOUT ARMS

1. **Performance.** Execute a Salute at the Halt Without Arms.
2. **Conditions**
 - a. Given:
 - (1) words of command;
 - (2) supervision; and
 - (3) assistance as required.
 - b. Denied: N/A.
 - c. Environmental: A drill hall or, in favourable weather, an outdoor parade square.
3. **Standard.** In accordance with A-PD-201-000/PT-000, the cadet shall execute salutes at the halt without arms, to the left and right.

4. **Teaching Points**

TP	Description	Method	Time	Ref
TP1	Explain and demonstrate saluting to the left and right at the halt and allow cadets to practice.	Demonstration and Performance	10 min	A0-002 (pp. 2-10 to 2-12)

5. **Time**
 - a. Introduction/Conclusion: 5 min
 - b. Demonstration and Performance: 10 min
 - c. Total: 15 min
6. **Substantiation.** The demonstration-performance method was chosen to allow cadets to participate in supervised exploration of practical instructional material. This method provides the instructor the opportunity to introduce the subject matter, demonstrate and explain procedures, and supervise the cadets while they imitate the skill. This method appeals to all learning styles.
7. **References.** A0-002 A-PD-201-000/PT-000 DHH 3-2. (2001). *The Canadian Forces Manual of Drill and Ceremonial*. Ottawa, ON: The Department of National Defence.
8. **Training Aids.** Assistant instructors as required.
9. **Learning Aids.** N/A.
10. **Test Details.** There is no formal assessment of this EO. Instructors will confirm the cadets' ability to perform the movements during the end of lesson check, and ongoing feedback will be provided during future drill practices, weekly parade nights, and ceremonial parades.
11. **Remarks.** N/A.



COMMON TRAINING
GREEN STAR
INSTRUCTIONAL GUIDE



SECTION 2

EO M108.02 – EXECUTE A SALUTE AT THE HALT WITHOUT ARMS

Total Time: 15 min

PREPARATION

PRE-LESSON INSTRUCTIONS

A complete list of resources needed for the instruction of this EO is located at Chapter 4 of the QSP. Specific uses for said stores are identified throughout the Instructional Guide, within the teaching point for which they are required.

Prior to instructing this lesson the instructor shall:

- review the lesson content, and become familiar with the material; and
- select the most effective squad formation for the lesson being taught. A squad may be in a single rank, hollow square or semi-circle for elementary drill instruction. (Note: All cadets **must** be able to fully observe all demonstrations and explanations.)

PRE-LESSON ASSIGNMENT

N/A.

APPROACH

This lesson will be presented using the demonstration and performance method. The demonstration and performance method was chosen to allow cadets to participate in supervised exploration of practical instructional material. This method provides the instructor the opportunity to introduce the subject matter, demonstrate and explain procedures, and supervise the cadets while they imitate the skill. This method appeals to all learning styles.



The instructor shall develop and use a vocabulary of short, concise words to impress on the squad that the movements must be performed smartly. For example, the words “crack”, “drive”, “seize” and “grasp” suggest the degree of smartness required. Profanity or personal sarcasm shall never be used.

INTRODUCTION

REVIEW

N/A.

A-CR-CCP-701/PF-001

OBJECTIVES

By the end of this lesson the cadet shall be expected to execute a salute at the halt without arms.

IMPORTANCE

As members of the Canadian Cadet Organization (CCO) cadets will be required to perform drill movements at a competent level, developing sharpness, esprit de corps, physical coordination, and alertness. These movements will be executed with ease and without hesitation. Ensuring that the cadets efficiently move together as one will promote discipline, alertness, precision, pride, steadiness, and cohesion. This develops the basis of teamwork that the CCO depends on.

Teaching Point 1

Execute a Salute to the Right (Left)

Time: 10 min

Method: Demonstration and Performance

DEMONSTRATE THE COMPLETE MOVEMENT WITH TIMING



Instructors are reminded that they are to present the example with regards to drill, from the moment they step onto the parade square. Proper drill movements, combined with a professional demeanour, are of paramount importance, and must be exemplified throughout the period of instruction.

The instructor shall provide a complete demonstration of the drill movement, with timing. A practiced assistant instructor may carry out this demonstration.

The demonstration shall be provided from various vantage points, as required.

The salute is given with the right hand. When physical incapacity or carrying of articles makes a salute with the right hand impracticable, compliments will be paid by turning the head and eyes to the left or right or standing to attention, as appropriate (see also A-PD-201-000/PT-000, Chapter 1, Section 2).

DEMONSTRATE FIRST PART OF MOVEMENT (FIRST NUMBER)



For ease of instruction, drill commands have been broken down into individual movements, or numbers. The instructor(s) shall demonstrate and explain each number.

On the command TO THE RIGHT (LEFT) SALUTE BY NUMBERS, SQUAD – ONE, saluting shall:

1. bend the right elbow and open the palm of the right hand as it passes the shoulder; and
2. force the right hand by its shortest route to the front of the headdress so that the:
 - a. palm of the hand is facing down;
 - b. thumb and fingers are fully extended and close together;
 - c. tip of the second finger is in line with the outside of the right eyebrow and touching the outside edge of the headdress or arm of glasses, if worn;
 - d. hand, wrist and forearm are in a straight line and at a 45 degree angle to the upper arm; and
 - e. upper arm is parallel to the ground.

3. the head and eyes shall be turned smartly to the right (left) as far as possible without straining, remembering the following:
 - a. when saluting to the left, the right hand, wrist and arm are brought further over to the left to the correct position in line with the outside edge of the right eyebrow; and
 - b. when saluting to the right, the arm is moved to the rear, with the tip of the second finger remaining in line with the outside edge of the right eyebrow.

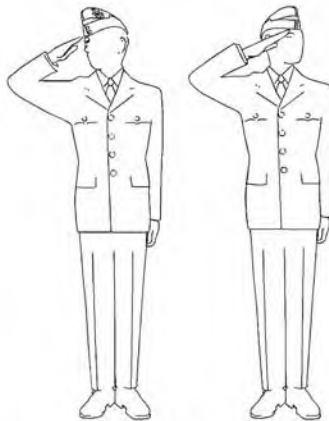

A-PD-201-000/PT-000, *The Canadian Forces Manual of Drill and Ceremonial*, 2001

Figure 8-2-1 Saluting to the Right and Left

PRACTICE THE SQUAD ON THE FIRST MOVEMENT

Practice the squad on the first movement collectively, individually and collectively.



Constant checking and correcting of all faults is essential. Faults shall be corrected immediately after they occur.

DEMONSTRATE AND EXPLAIN THE SECOND PART OF THE MOVEMENT

On the command SQUAD – TWO, the hand is brought sharply to the position of attention, and simultaneously the head and eyes are turned smartly to the front.

PRACTICE THE SQUAD ON THE SECOND MOVEMENT

Practice the squad on the second movement collectively, individually and collectively.

GIVE TWO COMPLETE AND FINAL DEMONSTRATIONS

On the command TO THE RIGHT (LEFT) – SALUTE, the two movements are combined. The standard pause shall be observed between movements.

The instructor(s) shall provide a full demonstration and allow time for practice.

A-CR-CCP-701/PF-001



Standard Pause: The standard pause between each movement is two beats in quick time. For example, on the command MOVE TO THE RIGHT IN FILE, RIGHT – TURN, the squad:

1. executes the first movement of the turn on the executive order and simultaneously calls out "ONE";
2. after completing the first movement, calls "TWO", "THREE" while observing the standard pause; and
3. when executing the final movement, calls out "ONE".

CONFIRMATION OF TEACHING POINT 1

Cadets will execute salutes to the left and left as a squad.

END OF LESSON CONFIRMATION

The cadets' participation in TP1 will serve as the confirmation of this lesson.

CONCLUSION

HOMEWORK/READING/PRACTICE

N/A.

METHOD OF EVALUATION

In accordance with A-PD-201-000/PT-000, *The Canadian Forces Manual of Drill and Ceremonial*, the cadet shall participate in an Annual Ceremonial Review (ACR) parade. This movement will be used in preparation for, and execution of, the ACR parade.

CLOSING STATEMENT

The hallmarks of cadet drill are efficiency, precision, and dignity. These qualities are developed through self-discipline and practice. They lead to unit pride and cohesion. Good drill, that is well rehearsed, closely supervised and precise, is an exercise in obedience and alertness. It sets the standard for the execution of any duty, both for the individual and the unit, and builds a sense of confidence between commander and subordinate that is essential to high morale. The personal qualities developed on the parade ground must be maintained in all aspects of life.

INSTRUCTOR NOTES/REMARKS

N/A.

REFERENCES

- A0-002 A-PD-201-000/PT-000 DHH 3-2. (2001). *The Canadian Forces Manual of Drill and Ceremonial*. Ottawa, ON: The Department of National Defence.

THIS PAGE INTENTIONALLY LEFT BLANK

MODIFIED LESSON SPECIFICATIONS AND INSTRUCTIONAL GUIDES – TP 1 OF EO M108.03

A-CR-CCP-701/PG-001

EO M108.03 – EXECUTE TURNS AT THE HALT

1. **Performance.** Execute Turns at the Halt.
2. **Conditions**
 - a. Given:
 - (1) words of command;
 - (2) supervision; and
 - (3) assistance as required.
 - b. Denied: N/A.
 - c. Environmental: A drill hall or, in favourable weather, an outdoor parade square.
3. **Standard.** In accordance with A-PD-201-000/PT-000, the cadet shall perform the movement of right turn at the halt.
4. **Teaching Points**

TP	Description	Method	Time	Ref
TP1	Explain and demonstrate the movement of right turn at the halt and allow cadets to practice.	Demonstration and Performance	10 min	A0-002 (pp. 2-12 to 2-13)

5. **Time**
 - a. Introduction/Conclusion: 5 min
 - b. Demonstration and Performance: 10 min
 - c. Total: 15 min
6. **Substantiation.** The demonstration-performance method was chosen to allow cadets to participate in supervised exploration of practical instructional material. This method provides the instructor the opportunity to introduce the subject matter, demonstrate and explain procedures, and supervise the cadets while they imitate the skill. This method appeals to all learning styles.
7. **References.** A0-002 A-PD-201-000/PT-000 DHH 3-2. (2001). *The Canadian Forces Manual of Drill and Ceremonial*. Ottawa, ON: The Department of National Defence.
8. **Training Aids.** Assistant instructors as required.
9. **Learning Aids.** N/A.
10. **Test Details.** There is no formal assessment of this EO. Instructors will confirm the cadets' ability to perform the movements during the end of lesson check, and ongoing feedback will be provided during future drill practices, weekly parade nights, and ceremonial parades.
11. **Remarks.** N/A.



COMMON TRAINING
GREEN STAR
INSTRUCTIONAL GUIDE



SECTION 3

EO M108.03 – EXECUTE TURNS AT THE HALT

Total Time: 15 min

PREPARATION

PRE-LESSON INSTRUCTIONS

A complete list of resources needed for the instruction of this EO is located at Chapter 4 of the QSP. Specific uses for said stores are identified throughout the Instructional Guide, within the teaching point for which they are required.

Prior to instructing this lesson the instructor shall:

- review the lesson content, and become familiar with the material; and
- select the most effective squad formation for the lesson being taught. A squad may be in a single rank, hollow square or semi-circle for elementary drill instruction. (Note: All cadets **must** be able to fully observe all demonstrations and explanations.)

PRE-LESSON ASSIGNMENT

N/A.

APPROACH

This lesson will be presented using the demonstration and performance method. The demonstration and performance method was chosen to allow cadets to participate in supervised exploration of practical instructional material. This method provides the instructor the opportunity to introduce the subject matter, demonstrate and explain procedures, and supervise the cadets while they imitate the skill. This method appeals to all learning styles.



The instructor shall develop and use a vocabulary of short, concise words to impress on the squad that the movements must be performed smartly. For example, the words “crack”, “drive”, “seize” and “grasp” suggest the degree of smartness required. Profanity or personal sarcasm shall never be used.

INTRODUCTION

REVIEW

N/A.

A-CR-CCP-701/PF-001

OBJECTIVES

By the end of this lesson the cadet shall be expected to execute right turns at the halt.

IMPORTANCE

As members of the Canadian Cadet Movement (CCM) cadets will be required to perform drill movements at a competent level, developing sharpness, esprit de corps, physical coordination, and alertness. These movements will be executed with ease and without hesitation. Ensuring that the cadets efficiently move together as one will promote discipline, alertness, precision, pride, steadiness, and cohesion. This develops the basis of teamwork that the CCM depends on.

Teaching Point 1

Execute Right Turns

Time: 10 min

Method: Demonstration and Performance

DEMONSTRATE THE COMPLETE MOVEMENT WITH TIMING



Instructors are reminded that they are to present the example with regards to drill, from the moment they step onto the parade square. Proper drill movements, combined with a professional demeanour, are of paramount importance, and must be exemplified throughout the period of instruction.

The instructor shall provide a complete demonstration of the drill movement, with timing. A practiced assistant instructor may carry out this demonstration.

The demonstration shall be provided from various vantage points, as required.

Turns and inclines are made to change direction: right or left turns change direction by 90°, about turns by 180°, and right and left inclines (not instructed in this lesson) by 45°.

DEMONSTRATE FIRST PART OF MOVEMENT (FIRST NUMBER)



For ease of instruction, drill commands have been broken down into individual movements, or numbers. The instructor(s) shall demonstrate and explain each number.

The cadet shall execute a right turn, by:

On the command RIGHT TURN BY NUMBERS, SQUAD – ONE, turning 90° to the right by pivoting on the right heel and left toe and raising the left heel and right toe simultaneously. Both knees will be kept braced during the turn, arms at the sides and body erect. On the completion of the movement, the weight of the body is placed on the right foot and the left leg is braced with the heel off the ground.

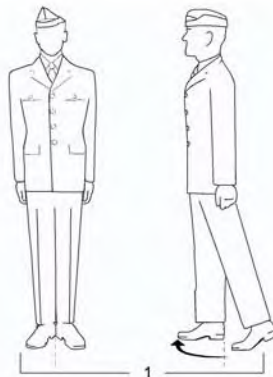

A-PD-201-000/PT-000, The Canadian Forces Manual of Drill and Ceremonial, 2001

Figure 8-3-1 Squad One – Right Turn at the Halt

PRACTICE THE SQUAD ON THE FIRST MOVEMENT

Practice the squad on the first movement collectively, individually and collectively.



Constant checking and correcting of all faults is essential. Faults shall be corrected immediately after they occur.

DEMONSTRATE AND EXPLAIN THE SECOND PART OF THE MOVEMENT

On the command SQUAD – TWO, the cadets shall bend the left knee, straightening it in double time and smartly placing the left foot beside the right to assume the position of attention.

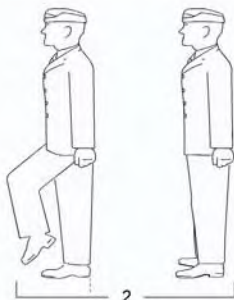

A-PD-201-000/PT-000, The Canadian Forces Manual of Drill and Ceremonial, 2001

Figure 8-3-2 Squad Two – Right Turn at the Halt

PRACTICE THE SQUAD ON THE SECOND MOVEMENT

Practice the squad on the second movement collectively, individually and collectively.

A-CR-CCP-701/PF-001

GIVE TWO COMPLETE AND FINAL DEMONSTRATIONS

On the command RIGHT – TURN, combine the two movements. The standard pause shall be observed between the movements.

The instructor(s) shall provide a full demonstration and allow time for practice.



Standard Pause: The standard pause between each movement is two beats in quick time. For example, on the command MOVE TO THE RIGHT IN FILE, RIGHT – TURN, the squad:

1. executes the first movement of the turn on the executive order and simultaneously calls out "ONE";
2. after completing the first movement, calls "TWO", "THREE" while observing the standard pause; and
3. when executing the final movement, calls out "ONE".

CONFIRMATION OF TEACHING POINT 1

Cadets will execute right turns as a squad.

END OF LESSON CONFIRMATION

The cadets' participation in TP1 will serve as the confirmation of this lesson.

CONCLUSION

HOMEWORK/READING/PRACTICE

N/A.

METHOD OF EVALUATION

In accordance with A-PD-201-000/PT-000, *The Canadian Forces Manual of Drill and Ceremonial*, the cadet shall participate in an Annual Ceremonial Review (ACR) parade. This movement will be used in preparation for, and in the execution of, the ACR parade.

CLOSING STATEMENT

The hallmarks of cadet drill are efficiency, precision, and dignity. These qualities are developed through self-discipline and practice. They lead to unit pride and cohesion. Good drill that is well rehearsed, closely supervised and precise, is an exercise in obedience and alertness. It sets the standard for the execution of any duty, both for the individual and the unit, and builds a sense of confidence between commander and subordinate that is essential to high morale. The personal qualities developed on the parade ground must be maintained in all aspects of life.

INSTRUCTOR NOTES/REMARKS

N/A.

REFERENCES

- A0-002 A-PD-201-000/PT-000 DHH 3-2. (2001). *The Canadian Forces Manual of Drill and Ceremonial*. Ottawa, ON: The Department of National Defence.

MODIFIED LESSON SPECIFICATIONS AND INSTRUCTIONAL GUIDES – TP 1 OF EO M108.03

A-CR-CCP-701/PG-001

EO M108.03 – EXECUTE TURNS AT THE HALT

1. **Performance.** Execute Turns at the Halt.
2. **Conditions**
 - a. Given:
 - (1) words of command;
 - (2) supervision; and
 - (3) assistance as required.
 - b. Denied: N/A.
 - c. Environmental: A drill hall or, in favourable weather, an outdoor parade square.
3. **Standard.** In accordance with A-PD-201-000/PT-000, the cadet shall perform the movement of left turn at the halt.

4. **Teaching Points**

TP	Description	Method	Time	Ref
TP1	Explain and demonstrate the movement of left turn at the halt and allow cadets to practice.	Demonstration and Performance	10 min	A0-002 (pp. 2-12 to 2-13)

5. **Time**
 - a. Introduction/Conclusion: 5 min
 - b. Demonstration and Performance: 10 min
 - c. Total: 15 min
6. **Substantiation.** The demonstration-performance method was chosen to allow cadets to participate in supervised exploration of practical instructional material. This method provides the instructor the opportunity to introduce the subject matter, demonstrate and explain procedures, and supervise the cadets while they imitate the skill. This method appeals to all learning styles.
7. **References.** A0-002 A-PD-201-000/PT-000 DHH 3-2. (2001). *The Canadian Forces Manual of Drill and Ceremonial*. Ottawa, ON: The Department of National Defence.
8. **Training Aids.** Assistant instructors as required.
9. **Learning Aids.** N/A.
10. **Test Details.** There is no formal assessment of this EO. Instructors will confirm the cadets' ability to perform the movements during the end of lesson check, and ongoing feedback will be provided during future drill practices, weekly parade nights, and ceremonial parades.
11. **Remarks.** N/A.



COMMON TRAINING
GREEN STAR
INSTRUCTIONAL GUIDE



SECTION 3

EO M108.03 – EXECUTE TURNS AT THE HALT

Total Time: 15 min

PREPARATION

PRE-LESSON INSTRUCTIONS

A complete list of resources needed for the instruction of this EO is located at Chapter 4 of the QSP. Specific uses for said stores are identified throughout the Instructional Guide, within the teaching point for which they are required.

Prior to instructing this lesson the instructor shall:

- review the lesson content, and become familiar with the material; and
- select the most effective squad formation for the lesson being taught. A squad may be in a single rank, hollow square or semi-circle for elementary drill instruction. (Note: All cadets **must** be able to fully observe all demonstrations and explanations.)

PRE-LESSON ASSIGNMENT

N/A.

APPROACH

This lesson will be presented using the demonstration and performance method. The demonstration and performance method was chosen to allow cadets to participate in supervised exploration of practical instructional material. This method provides the instructor the opportunity to introduce the subject matter, demonstrate and explain procedures, and supervise the cadets while they imitate the skill. This method appeals to all learning styles.



The instructor shall develop and use a vocabulary of short, concise words to impress on the squad that the movements must be performed smartly. For example, the words "crack", "drive", "seize" and "grasp" suggest the degree of smartness required. Profanity or personal sarcasm shall never be used.

INTRODUCTION

REVIEW

N/A.

A-CR-CCP-701/PF-001

OBJECTIVES

By the end of this lesson the cadet shall be expected to execute left turns at the halt.

IMPORTANCE

As members of the Canadian Cadet Movement (CCM) cadets will be required to perform drill movements at a competent level, developing sharpness, esprit de corps, physical coordination, and alertness. These movements will be executed with ease and without hesitation. Ensuring that the cadets efficiently move together as one will promote discipline, alertness, precision, pride, steadiness, and cohesion. This develops the basis of teamwork that the CCM depends on.

Teaching Point 1

Execute Left Turns

Time: 10 min

Method: Demonstration and Performance

DEMONSTRATE THE COMPLETE MOVEMENT WITH TIMING



Instructors are reminded that they are to present the example with regards to drill, from the moment they step onto the parade square. Proper drill movements, combined with a professional demeanour, are of paramount importance, and must be exemplified throughout the period of instruction.

The instructor shall provide a complete demonstration of the drill movement, with timing. A practiced assistant instructor may carry out this demonstration.

The demonstration shall be provided from various vantage points, as required.

Turns and inclines are made to change direction: right or left turns change direction by 90°, about turns by 180°, and right and left inclines by 45°.

DEMONSTRATE FIRST PART OF MOVEMENT (FIRST NUMBER)



For ease of instruction, drill commands have been broken down into individual movements, or numbers. The instructor(s) shall demonstrate and explain each number.

The cadet shall execute a left turn, by:

On the command LEFT TURN BY NUMBERS, SQUAD – ONE, turning 90° to the left by pivoting on the left heel and right toe and raising the right heel and left toe simultaneously. Both knees will be kept braced during the turn, arms at the sides and body erect. On the completion of the movement, the weight of the body is placed on the left foot and the right leg is braced with the heel off the ground.

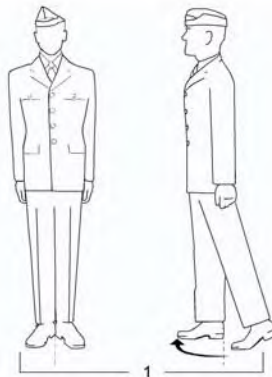

A-PD-201-000/PT-000, The Canadian Forces Manual of Drill and Ceremonial, 2001

Figure 8-3-1 Squad One – Turn at the Halt

PRACTICE THE SQUAD ON THE FIRST MOVEMENT

Practice the squad on the first movement collectively, individually and collectively.



Constant checking and correcting of all faults is essential. Faults shall be corrected immediately after they occur.

DEMONSTRATE AND EXPLAIN THE SECOND PART OF THE MOVEMENT (NUMBER TWO)

On the command SQUAD – TWO, bend the right knee, straightening it in double time and smartly placing the right foot beside the left to assume the position of attention.

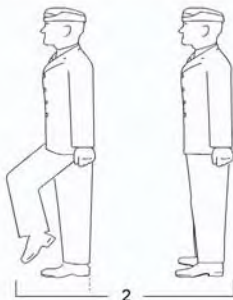

A-PD-201-000/PT-000, The Canadian Forces Manual of Drill and Ceremonial, 2001

Figure 8-3-2 Squad Two – Turn at the Halt

PRACTICE THE SQUAD ON THE SECOND MOVEMENT

Practice the squad on the second movement collectively, individually and collectively.

A-CR-CCP-701/PF-001

GIVE TWO COMPLETE AND FINAL DEMONSTRATIONS

On the command LEFT – TURN, combine the two movements. The standard pause shall be observed between the movements.

The instructor(s) shall provide a full demonstration and allow time for practice.



Standard Pause: The standard pause between each movement is two beats in quick time. For example, on the command MOVE TO THE LEFT IN FILE, LEFT – TURN, the squad:

1. Executes the first movement of the turn on the executive order and simultaneously calls out "ONE".
2. After completing the first movement, calls "TWO", "THREE" while observing the standard pause.
3. When executing the final movement, calls out "ONE".

CONFIRMATION OF TEACHING POINT 1

Cadets will execute LEFT turns as a squad.

END OF LESSON CONFIRMATION

The cadets' participation in TP1 will serve as the confirmation of this lesson.

CONCLUSION

HOMEWORK/READING/PRACTICE

N/A.

METHOD OF EVALUATION

In accordance with A-PD-201-000/PT-000, *The Canadian Forces Manual of Drill and Ceremonial*, the cadet shall participate in an Annual Ceremonial Review (ACR) parade. This movement will be used in preparation for, and in the execution of, the ACR parade.

CLOSING STATEMENT

The hallmarks of cadet drill are efficiency, precision, and dignity. These qualities are developed through self-discipline and practice. They lead to unit pride and cohesion. Good drill that is well rehearsed, closely supervised and precise, is an exercise in obedience and alertness. It sets the standard for the execution of any duty, both for the individual and the unit, and builds a sense of confidence between commander and subordinate that is essential to high morale. The personal qualities developed on the parade ground must be maintained in all aspects of life.

INSTRUCTOR NOTES/REMARKS

N/A.

REFERENCES

- A0-002 A-PD-201-000/PT-000 DHH 3-2. (2001). *The Canadian Forces Manual of Drill and Ceremonial*.
Ottawa, ON: The Department of National Defence.

MODIFIED LESSON SPECIFICATIONS AND INSTRUCTIONAL GUIDES – TP 1 OF EO M108.03

A-CR-CCP-701/PG-001

EO M108.03 – EXECUTE TURNS AT THE HALT

1. **Performance.** Execute Turns at the Halt.
2. **Conditions**
 - a. Given:
 - (1) words of command;
 - (2) supervision; and
 - (3) assistance as required.
 - b. Denied: N/A.
 - c. Environmental: A drill hall or, in favourable weather, an outdoor parade square.
3. **Standard.** In accordance with A-PD-201-000/PT-000, the cadet shall perform the movement of about turn at the halt.

4. **Teaching Points**

TP	Description	Method	Time	Ref
TP1	Explain and demonstrate the movement of about turn at the halt and allow cadets to practice.	Demonstration and Performance	10 min	A0-002 (pp. 2-12 to 2-13)

5. **Time**
 - a. Introduction/Conclusion: 5 min
 - b. Demonstration and Performance: 10 min
 - c. Total: 15 min
6. **Substantiation.** The demonstration-performance method was chosen to allow cadets to participate in supervised exploration of practical instructional material. This method provides the instructor the opportunity to introduce the subject matter, demonstrate and explain procedures, and supervise the cadets while they imitate the skill. This method appeals to all learning styles.
7. **References.** A0-002 A-PD-201-000/PT-000 DHH 3-2. (2001). *The Canadian Forces Manual of Drill and Ceremonial*. Ottawa, ON: The Department of National Defence.
8. **Training Aids.** Assistant instructors as required.
9. **Learning Aids.** N/A.
10. **Test Details.** There is no formal assessment of this EO. Instructors will confirm the cadets' ability to perform the movements during the end of lesson check, and ongoing feedback will be provided during future drill practices, weekly parade nights, and ceremonial parades.
11. **Remarks.** N/A.



COMMON TRAINING
GREEN STAR
INSTRUCTIONAL GUIDE



SECTION 3

EO M108.03 – EXECUTE TURNS AT THE HALT

Total Time: 15 min

PREPARATION

PRE-LESSON INSTRUCTIONS

A complete list of resources needed for the instruction of this EO is located at Chapter 4 of the QSP. Specific uses for said stores are identified throughout the Instructional Guide, within the teaching point for which they are required.

Prior to instructing this lesson the instructor shall:

- review the lesson content, and become familiar with the material; and
- select the most effective squad formation for the lesson being taught. A squad may be in a single rank, hollow square or semi-circle for elementary drill instruction. (Note: All cadets **must** be able to fully observe all demonstrations and explanations.)

PRE-LESSON ASSIGNMENT

N/A.

APPROACH

This lesson will be presented using the demonstration and performance method. The demonstration and performance method was chosen to allow cadets to participate in supervised exploration of practical instructional material. This method provides the instructor the opportunity to introduce the subject matter, demonstrate and explain procedures, and supervise the cadets while they imitate the skill. This method appeals to all learning styles.



The instructor shall develop and use a vocabulary of short, concise words to impress on the squad that the movements must be performed smartly. For example, the words “crack”, “drive”, “seize” and “grasp” suggest the degree of smartness required. Profanity or personal sarcasm shall never be used.

INTRODUCTION

REVIEW

N/A.

A-CR-CCP-701/PF-001

OBJECTIVES

By the end of this lesson the cadet shall be expected to execute about turns at the halt.

IMPORTANCE

As members of the Canadian Cadet Movement (CCM) cadets will be required to perform drill movements at a competent level, developing sharpness, esprit de corps, physical coordination, and alertness. These movements will be executed with ease and without hesitation. Ensuring that the cadets efficiently move together as one will promote discipline, alertness, precision, pride, steadiness, and cohesion. This develops the basis of teamwork that the CCM depends on.

Teaching Point 1

Execute About Turn

Time: 10 min

Method: Demonstration and Performance

DEMONSTRATE THE COMPLETE MOVEMENT WITH TIMING



Instructors are reminded that they are to present the example with regards to drill, from the moment they step onto the parade square. Proper drill movements, combined with a professional demeanour, are of paramount importance, and must be exemplified throughout the period of instruction.

The instructor shall provide a complete demonstration of the drill movement, with timing. A practiced assistant instructor may carry out this demonstration.

The demonstration shall be provided from various vantage points, as required.

DEMONSTRATE FIRST PART OF MOVEMENT (FIRST NUMBER)

On the command ABOUT TURN BY NUMBERS, SQUAD – ONE, turning 180° to the right by pivoting on the right heel and left toe and raising the left heel and right toe simultaneously. Both knees will be kept braced during the turn, arms at the sides and body erect. On the completion of the movement, the weight of the body is placed on the right foot and the left leg is braced with the heel off the ground.

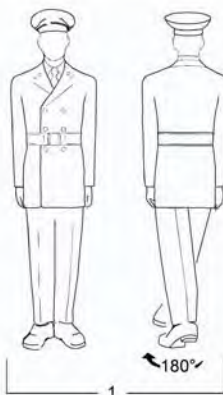

A-PD-201-000/PT-000, *The Canadian Forces Manual of Drill and Ceremonial*, 2001

Figure 8-3-1 Squad One – About Turn at the Halt

PRACTICE THE SQUAD ON THE FIRST MOVEMENT

Practice the squad on the first movement collectively, individually and collectively.



Constant checking and correcting of all faults is essential. Faults shall be corrected immediately after they occur.

DEMONSTRATE AND EXPLAIN THE SECOND PART OF THE MOVEMENT (SECOND NUMBER)

On the command SQUAD – TWO, bending the left knee, straightening it in double time and smartly placing the left foot beside the right to assume the position of attention.

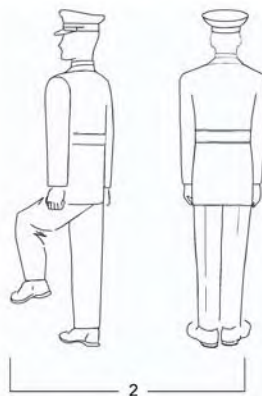

A-PD-201-000/PT-000, The Canadian Forces Manual of Drill and Ceremonial, 2001

Figure 8-3-2 Squad Two – About Turn at the Halt

PRACTICE THE SQUAD ON THE SECOND MOVEMENT

Practice the squad on the second movement collectively, individually and collectively.

GIVE TWO COMPLETE AND FINAL DEMONSTRATIONS

On the command ABOUT – TURN, combine the two movements. The standard pause shall be observed between the movements.

The instructor(s) shall provide a full demonstration and allow time for practice.

A-CR-CCP-701/PF-001



Standard Pause: The standard pause between each movement is two beats in quick time. For example, on the command ABOUT – TURN, combine the two movements. The standard pause shall be observed between the movements:

1. Executes the first movement of the turn on the executive order and simultaneously calls out "ONE".
2. After completing the first movement, calls "TWO", "THREE" while observing the standard pause.
3. When executing the final movement, calls out "ONE".

CONFIRMATION OF TEACHING POINT 1

Cadets will execute about turns as a squad.

END OF LESSON CONFIRMATION

The cadets' participation in TP1 will serve as the confirmation of this lesson.

CONCLUSION

HOMEWORK/READING/PRACTICE

N/A.

METHOD OF EVALUATION

In accordance with A-PD-201-000/PT-000, *The Canadian Forces Manual of Drill and Ceremonial*, the cadet shall participate in an Annual Ceremonial Review (ACR) parade. This movement will be used in preparation for, and in the execution of, the ACR parade.

CLOSING STATEMENT

The hallmarks of cadet drill are efficiency, precision, and dignity. These qualities are developed through self-discipline and practice. They lead to unit pride and cohesion. Good drill that is well rehearsed, closely supervised and precise, is an exercise in obedience and alertness. It sets the standard for the execution of any duty, both for the individual and the unit, and builds a sense of confidence between commander and subordinate that is essential to high morale. The personal qualities developed on the parade ground must be maintained in all aspects of life.

INSTRUCTOR NOTES/REMARKS

N/A.

REFERENCES

A0-002 A-PD-201-000/PT-000 DHH 3-2. (2001). *The Canadian Forces Manual of Drill and Ceremonial*. Ottawa, ON: The Department of National Defence.

THIS PAGE INTENTIONALLY LEFT BLANK

DRILL INSTRUCTIONAL TECHNIQUES – ASSESSMENT FORM

Cadet's Name: _____

Platoon: _____

Lesson Topic: _____

Criteria	Comments	Incomplete	Completed With Difficulty	Completed Without Difficulty
PREPARATION				
Maintained dress and deportment.				
Selected an appropriate squad formation.				
Used a lesson plan.				
Reviewed previous lesson.				
INTRODUCTION				
Stated what the cadets will learn.				
Stated why it is important.				
Stated where/when this skill will be applied.				
BODY				
Demonstrated complete movement, calling the time.				
Demonstrated and explained the first part of the movement (Squad 1).				
Had the squad practice the first part of the movement collectively, individually and collectively again.				
Taught the second part of the movement and each subsequent part in the same manner.				
Gave two complete demonstrations.				
Practiced the complete movement with: <ul style="list-style-type: none"> • the instructor calling the time, • the cadets calling the time, and • the cadets judging the time. 				

Criteria	Comments	Incomplete	Completed With Difficulty	Completed Without Difficulty
Used clear words of command and correct pauses.				
Gave appropriate and immediate feedback.				
Allowed questions after each movement.				
END OF LESSON CONFIRMATION				
Demonstrated the movement taught.				
Confirmation was conducted as a squad.				
Emphasized aspects of the movement with which the cadets experienced difficulty.				
CONCLUSION				
Summarized the lesson.				
Re-motivated the cadets.				
FEEDBACK				

 Assessor's Signature

 Date

 Cadet's Signature

CHAPTER 10

PO 311 – PARTICIPATE IN A RECREATIONAL SUMMER BIATHLON ACTIVITY



COMMON TRAINING
SILVER STAR
INSTRUCTIONAL GUIDE



SECTION 1

**EO C311.01 – PRACTICE AIMING AND FIRING THE
CADET AIR RIFLE FOLLOWING PHYSICAL ACTIVITY**

Total Time:

90 min

PREPARATION

PRE-LESSON INSTRUCTIONS

Resources needed for the delivery of this lesson are listed in the lesson specification located in A-CR-CCP-703/PG-001, Chapter 4. Specific uses for said resources are identified throughout the instructional guide within the TP for which they are required.

Review the lesson content and become familiar with the material prior to delivering the lesson.

PRE-LESSON ASSIGNMENT

N/A.

APPROACH

An interactive lecture was chosen for TPs 1 and 2 to review aiming and firing techniques.

A practical activity was chosen for TPs 3–6 as it is an interactive way to allow the cadets to experience aiming and firing the cadet air rifle following physical activity.

INTRODUCTION

REVIEW

N/A.

OBJECTIVES

By the end of this lesson the cadet shall have practiced aiming and firing the cadet air rifle following physical activity.

IMPORTANCE

It is important for cadets to practice aiming and firing the cadet air rifle following physical activity because these skills are essential to summer biathlon training.

Teaching Point 1**IAW EO C206.02 (Practice Aiming Techniques, A-CR-CCP-702/PF-001, Chapter 6, Section 3), Review Breathing Techniques**

Time: 5 min

Method: Interactive Lecture

Breathing supplies the blood stream with oxygen and eliminates waste elements (such as carbon dioxide) from the blood. While breathing, the oxygen inhaled is used to supply muscles with energy, ensuring optimal potential of the muscles. Just like in sports, controlled breathing can affect marksmanship outcomes.

CONTROLLED BREATHING

Once a stable prone position is established, integrate the principles of controlled breathing. For maximum stability when firing, hold the breath for five to seven seconds. It is very important not to hold the breath for more than seven seconds, as tension will increase in the chest, muscles will lack oxygen and stability will be reduced. When the body lacks oxygen, muscles will quiver and eyesight will be negatively affected.

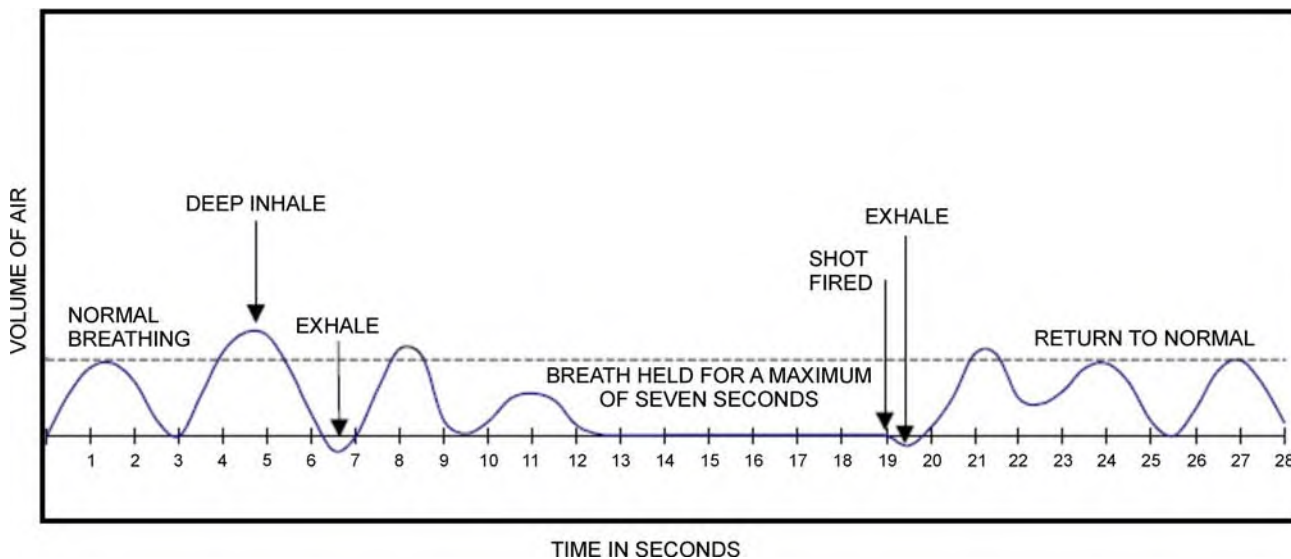

A-CR-CCP-177/PT-001 (p. 1-5-9)

Figure 10-1-1 Marksmanship Breathing Cycle

ACHIEVING A CONTROLLED BREATHING SEQUENCE

The following is the recommended method for achieving a controlled breathing sequence:

1. Adopt the prone position.
2. Relax and breathe normally.
3. Obtain a sight picture.
4. Inhale and exhale deeply.
5. Inhale deeply and exhale normally.
6. Relax the chest muscles, hold a breath for five to seven seconds and squeeze the trigger.
7. Exhale completely and resume normal breathing.

CONFIRMATION OF TEACHING POINT 1

QUESTIONS

- Q1. Breathing supplies the blood stream with what?
- Q2. Oxygen supplies what with energy?
- Q3. For how long should the breath be held while firing?

ANTICIPATED ANSWERS

- A1. Oxygen.
- A2. The muscles.
- A3. Five to seven seconds.

Teaching Point 2

IAW EO C206.03 (Practice Firing Techniques, A-CR-CCP-702/PF-001, Chapter 6, Section 4), Review Natural Sight Alignment

Time: 5 min

Method: Interactive Lecture

Natural alignment describes the direction that the cadet air rifle is aimed when the marksman is in the prone position with the cadet air rifle at the ready. When in a comfortable position, the cadet air rifle should not be forced to point at the target. Even with a perfect prone position and sight alignment, forcing the air rifle can cause muscle tension and will affect the accuracy of each shot.

Natural alignment is obtained by:

- 1. adopting a comfortable prone position;
- 2. acquiring a sight picture;
- 3. closing both eyes;
- 4. taking several normal breaths to relax the muscles;
- 5. looking through sights when comfortable;
- 6. adjusting body position until a proper sight picture is achieved; and
- 7. proceeding to fire.

CONFIRMATION OF TEACHING POINT 2

QUESTIONS

- Q1. What is natural alignment?
- Q2. What can happen if the air rifle is forced to point at the target?
- Q3. What is the first step to obtaining natural alignment?

ANTICIPATED ANSWERS

- A1. The direction that the cadet air rifle is aimed when the marksman is in the prone position with the cadet air rifle at the ready.
- A2. Forcing the air rifle can cause muscle tension and will affect the accuracy of each shot.
- A3. Adopting a comfortable prone position.

Teaching Point 3

Conduct a Warm-Up Session, Composed of Light Cardiovascular Exercises

Time: 5 min

Method: Practical Activity



The following information will be explained to the cadets during the warm-up session.

PURPOSE OF A WARM-UP

A warm-up session is composed of stretches and light cardiovascular exercises designed to:

- stretch the muscles;
- gradually increase respiratory action and heart rate;
- expand the muscles' capillaries to accommodate the increase in blood circulation which occurs during physical activity; and
- raise the muscle temperature to facilitate reactions in muscle tissue.

GUIDELINES FOR STRETCHING

The following guidelines should be followed while stretching to prepare for physical activity and to help prevent injury:

- Stretch all major muscle groups, including the back, chest, legs, and shoulders.
- Never bounce while stretching.
- Hold each stretch for 10–30 seconds to let the muscles release fully.
- Repeat each stretch two to three times.
- When holding a stretch, support the limb at the joint.
- Static stretching, which is stretching a muscle and holding it in position without discomfort for 10–30 seconds, is considered the safest method.
- Stretching helps to relax the muscles and improve flexibility, which is the range of motion in the joints.
- As a guide, allow 10 minutes to warm up for every hour of physical activity.



The stretches chosen should focus on the areas of the body that will be used the most during the physical activity.

ACTIVITY

OBJECTIVE

The objective of this warm-up activity is to stretch the muscles and perform light cardiovascular exercises to prepare the body for physical activity and to help prevent injuries.

RESOURCES

N/A.

ACTIVITY LAYOUT

N/A.

ACTIVITY INSTRUCTIONS

1. Arrange the cadets in either a warm-up circle or in rows (as illustrated in Figures 10-1-2 and 10-1-3).

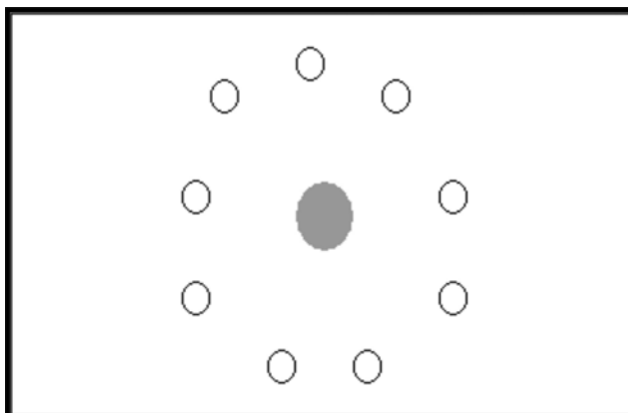

Director Cadets 3, 2006, Ottawa, ON: Department of National Defence

Figure 10-1-2 Instructor in the Centre of a Warm-Up Circle

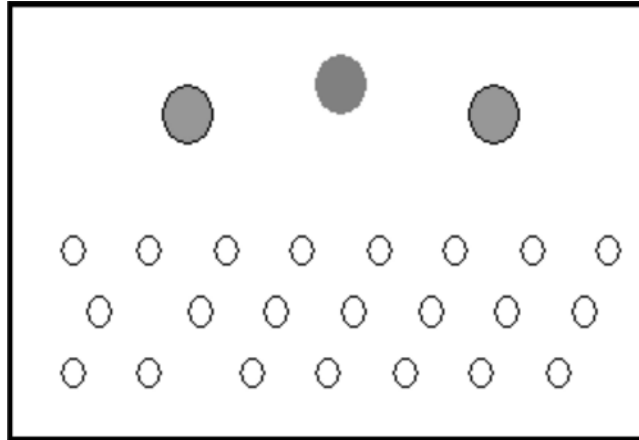

Director Cadets 3, 2006, Ottawa, ON: Department of National Defence

Figure 10-1-3 Instructor at the Front With Two Assistant Instructors

2. Demonstrate before having the cadets attempt each stretch/light cardiovascular exercise.
3. Assistant instructors may help demonstrate the exercises and ensure the cadets are performing them correctly.
4. Have cadets perform each stretch/light cardiovascular exercise.



Light cardiovascular exercises should be done to warm up the muscles prior to stretching to avoid injury to or tearing of the muscles. For example, running on the spot for 30 seconds or performing jumping jacks should be performed prior to conducting the stretches located at Annex A.

SAFETY

- Ensure there are at least two arm lengths between the cadets so they can move freely.
- Ensure the cadets perform the stretches and light cardiovascular exercises in a safe manner, following the guidelines for stretching listed in this TP.

CONFIRMATION OF TEACHING POINT 3

The cadets' participation in the warm-up session will serve as the confirmation of this TP.

Teaching Point 4	Conduct an Activity Where the Cadets Will Aim and Fire the Cadet Air Rifle Following Physical Activity
-------------------------	---

Time: 60 min

Method: Practical Activity

ACTIVITY

OBJECTIVE

The objective of this activity is to have the cadets aim and fire the cadet air rifle following physical activity, practicing breathing techniques and natural alignment.

RESOURCES

- Cadet air rifles (one per firing lane),
- Safety glasses/goggles (two per firing lane),
- Shooting mats (two per firing lane),
- Biathlon Air Rifle Targets (BARTs) (one per firing lane), and
- Coins (one per firing lane).



If resources are available, the number of firing lanes may be increased.

ACTIVITY LAYOUT

A range IAW Part 1, Section 8 of A-CR-CCP-177/PT-001.

ACTIVITY INSTRUCTIONS

1. Divide the cadets into pairs.
2. Have one cadet from each pair run or participate in some sort of activity to elevate their heart rate for five to ten minutes.
3. Have the same cadet from each pair approach the firing point and prepare to fire.
4. Have the cadet adopt the prone position and their partner balance a coin on the barrel of the cadet air rifle, just behind the front sight.
5. While practicing a controlled breathing sequence and natural alignment, the cadet shall dry fire the cadet air rifle while keeping the coin balanced.
6. Circulate throughout the training area and coach the cadets on their breathing techniques and natural alignment.
7. Have the cadets switch positions and repeat steps 2. to 5. until the activity time is complete.

SAFETY

Range activities will be conducted IAW A-CR-CCP-177/PT-001.

CONFIRMATION OF TEACHING POINT 4

The cadets' participation in the activity will serve as the confirmation of this TP.

Teaching Point 5

Conduct a Cool-Down Session, Composed of Light Cardiovascular Exercises

Time: 5 min

Method: Practical Activity



The following information will be explained to the cadets during the cool-down session.

PURPOSE OF A COOL-DOWN

A cool-down is composed of stretches and light cardiovascular exercises designed to:

- allow the body time to slowly recover from physical activity and to help prevent injury;
- prepare the respiratory system to return to its normal state; and
- stretch the muscles to help relax and restore them to their resting length.



The stretches chosen should focus on the areas of the body that were used the most during the sports activity.

ACTIVITY

OBJECTIVE

The objective of the cool-down is to stretch the muscles and perform light cardiovascular exercises that allow the body time to recover from physical activity, and to prevent injury.

RESOURCES

N/A.

ACTIVITY LAYOUT

N/A.

ACTIVITY INSTRUCTIONS

1. Arrange the cadets in either a warm-up circle or in rows (as illustrated in Figures 10-1-2 and 10-1-3).
2. Demonstrate before having the cadets attempt each stretch/light cardiovascular exercise.
3. Assistant instructors may help demonstrate the movements and ensure the cadets are performing them correctly.
4. Have cadets perform each stretch/light cardiovascular exercise.

SAFETY

- Ensure there are at least two arm lengths between the cadets so they can move freely.

- Ensure the cadets perform the stretches and light cardiovascular exercises in a safe manner, following the guidelines for stretching listed in TP 3.

CONFIRMATION OF TEACHING POINT 5

The cadets' participation in the cool-down session will serve as the confirmation of this TP.

END OF LESSON CONFIRMATION

The cadets' participation in the activity in TP 4 will serve as the confirmation of this lesson.

CONCLUSION

HOMework/READING/PRACTICE

N/A.

METHOD OF EVALUATION

N/A.

CLOSING STATEMENT

Being able to use breathing techniques and natural alignment while firing following physical activity may help to improve marksmanship skills for summer biathlon.

INSTRUCTOR NOTES/REMARKS

This lesson shall be taught prior to conducting EO C311.02 (Participate in a Recreational Summer Biathlon Activity, Section 2).

REFERENCES

- A0-027 A-CR-CCP-177/PT-001 Director Cadets 3. (2001). *Canadian Cadet Movement: Cadet Marksmanship Program Reference Manual*. Ottawa, ON: Department of National Defence.
- C0-002 (ISBN 0-88962-630-8) LeBlanc, J., & Dickson, L. (1997). *Straight Talk About Children and Sport: Advice for Parents, Coaches, and Teachers*. Oakville, ON: Mosaic Press.
- C0-089 (ISBN 0-936070-22-6) Anderson, B. (2000). *Stretching: 20th Anniversary* (Rev. ed.). Bolinas, CA: Shelter Publications, Inc.
- C0-149 Biathlon Canada. (2005). *Biathlon Bears: Community Coaching*. Ottawa, ON: Biathlon Canada.

THIS PAGE INTENTIONALLY LEFT BLANK



COMMON TRAINING
SILVER STAR
INSTRUCTIONAL GUIDE



SECTION 2

EO C311.02 – PARTICIPATE IN A RECREATIONAL SUMMER BIATHLON ACTIVITY

Total Time: 180 min

PREPARATION

PRE-LESSON INSTRUCTIONS

Resources needed for the delivery of this lesson are listed in the lesson specification located in A-CR-CCP-703/PG-001, Chapter 4. Specific uses for said resources are identified throughout the instructional guide within the TP for which they are required.

Review the lesson content and become familiar with the material prior to delivering the lesson.

Ensure that all members involved in conducting this activity are familiar with the competition guidelines located at Annex B.

Set up a first aid station.

Set up a running route of 1000 m.

Set up a range IAW A-CR-CCP-177/PT-001, Part 1, Section 8.

Photocopy Annexes C, D and E.

PRE-LESSON ASSIGNMENT

N/A.

APPROACH

A practical activity was chosen for this lesson as it is an interactive way for the cadets to participate in recreational summer biathlon. This activity contributes to the development of biathlon skills and knowledge, and promotes physical fitness in a fun and challenging setting.

INTRODUCTION

REVIEW

N/A.

OBJECTIVES

By the end of this lesson the cadet shall have participated in a recreational summer biathlon activity.

IMPORTANCE

It is important for the cadets to participate in a recreational summer biathlon activity because it requires personal discipline, develops marksmanship skills and promotes physical fitness.

Teaching Point 1

Explain the Components of a Recreational Summer Biathlon Activity

Time: 10 min

Method: Practical Activity



Describe the components of the recreational summer biathlon activity. Ensure that the cadets understand the course layout, rules and regulations, scoring, penalties and out of bound areas before the activity is conducted. The cadets should be made aware of the start area, the course, the firing range and the finish area.

COMPOSITION

Cadets will be divided into teams for the summer biathlon activity. For a group of 25 cadets, the cadets should be divided into groups of five.

COURSE LAYOUT

Each cadet will:

- run a route of approximately 1000 m;
- fire five to eight rounds in an effort to knock down all five targets on the biathlon air rifle target (BART);
- run a second route of approximately 1000 m;
- fire five to eight rounds in an effort to knock down all five targets on the BART;
- run a third route of approximately 1000 m; and
- finish the race.



The 1000 m route should be clearly marked prior to the start of this lesson.

RULES AND REGULATIONS

Rules and regulations for the recreational summer biathlon activity include the following:

- The cadets must remain in their own teams throughout the activity.
- The cadets must use the same firing lane for the duration of the activity.
- The run must be completed in the proper sequence and on the marked route.
- Cadet air rifles must be placed at the firing point by the range staff and will remain there for the duration of the activity.
- All firing will be done in the prone position.

- The cadet air rifle must be made safe upon completion of firing.
- An inoperable cadet air rifle will be replaced by the range staff, the target will be reset, and the cadet will fire five to eight rounds with the new cadet air rifle.
- Safety infractions will result in time penalties.
- Missed targets will result in time penalties.

SCORING

The team's final score is determined by adding the total time for all run routes plus any penalties issued. The team with the lowest final score is considered the winning team.

Scoring will be calculated as follows:

- **Time.** The team's final time is the time from the start to finish, and any penalties.
- **Targets.** For each relay of firing, the number of hit and missed targets will be recorded on the range recording sheet by the lane scorekeeper (located at Annex C). There is no positive point value for each hit target; competitors will be deducted points for each missed target.

PENALTIES

The following penalties will be added to the team's time:

- Each violation of the principles of fair play or good sportsmanship will result in a one-minute penalty, to include:
 - not giving way in an area of congestion;
 - pushing or shoving;
 - using profanity; and
 - interfering with other competitors.
- Each missed target will result in a 10-second penalty.
- Each safety infraction on the firing point will result in a two-minute penalty, to include:
 - not keeping control of the cadet air rifle;
 - moving forward of the firing point; and
 - intentionally firing rounds at objects other than the BART.
- Each team member that does not cross the finish line will receive a two-minute penalty.

OUT OF BOUNDS AREAS

Make cadets aware of all out of bounds areas and safety considerations depending on the training area.

CONFIRMATION OF TEACHING POINT 1

QUESTIONS

- Q1. What are two rules/regulations for this recreational summer biathlon activity?
- Q2. How will the recreational summer biathlon activity be scored?

Q3. What is one violation of the principles of fair play/good sportsmanship?

ANTICIPATED ANSWERS

A1. Rules and regulations for the recreational summer biathlon activity include the following:

- The cadets must remain in their own teams throughout the activity.
- The cadets must use the same firing lane for the duration of the activity.
- The run must be completed in the proper sequence and on the marked route.
- Cadet air rifles must be placed at the firing point by the range staff and will remain there for the duration of the activity.
- All firing will be done in the prone position.
- The cadet air rifle must be made safe upon completion of firing.
- An inoperable cadet air rifle will be replaced by the range staff, the target will be reset, and the cadet will fire five to eight rounds with the new rifle.
- Safety infractions will result in time penalties.
- Missed targets will result in time penalties.

A2. The activity will be scored based on time and penalties.

A3. Violations of the principles of fair play/good sportsmanship include:

- not giving way in an area of congestion;
- pushing or shoving;
- using profanity; and
- interfering with other competitors.

Teaching Point 2

Conduct a Warm-Up Session Composed of Light Cardiovascular Exercises

Time: 10 min

Method: Practical Activity



The following information will be explained to the cadets during the warm-up session.

PURPOSE OF A WARM-UP

A warm-up session is composed of stretches and light cardiovascular exercises designed to:

- stretch the muscles;
- gradually increase respiratory action and heart rate;
- expand the muscles' capillaries to accommodate the increase in blood circulation which occurs during physical activity; and

- raise the muscle temperature to facilitate reactions in muscle tissue.

GUIDELINES FOR STRETCHING

The following guidelines should be followed while stretching to prepare for physical activity and to help prevent injury:

- Stretch all major muscle groups, including the back, chest, legs, and shoulders.
- Never bounce while stretching.
- Hold each stretch for 10–30 seconds to let the muscles release fully.
- Repeat each stretch two to three times.
- When holding a stretch, support the limb at the joint.
- Static stretching, which is stretching a muscle and holding it in position without discomfort for 10–30 seconds, is considered the safest method.
- Stretching helps to relax the muscles and improve flexibility, which is the range of motion in the joints.
- As a guide, allow 10 minutes to warm up for every hour of physical activity.



The stretches chosen should focus on the areas of the body that will be used the most during the physical activity.

ACTIVITY

OBJECTIVE

The objective of this warm-up activity is to stretch the muscles and perform light cardiovascular exercises to prepare the body for physical activity and to help prevent injuries.

RESOURCES

N/A.

ACTIVITY LAYOUT

N/A.

ACTIVITY INSTRUCTIONS

1. Arrange the cadets in either a warm-up circle or in rows (as illustrated in Figures 10-2-1 and 10-2-2).

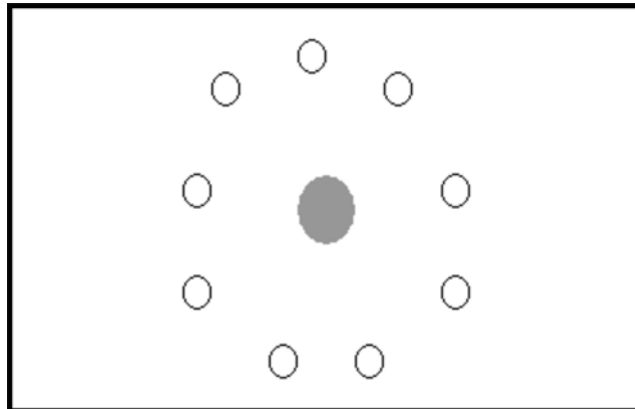

Director Cadets 3, 2006, Ottawa, ON: Department of National Defence

Figure 10-2-1 Instructor in the Centre of a Warm-Up Circle

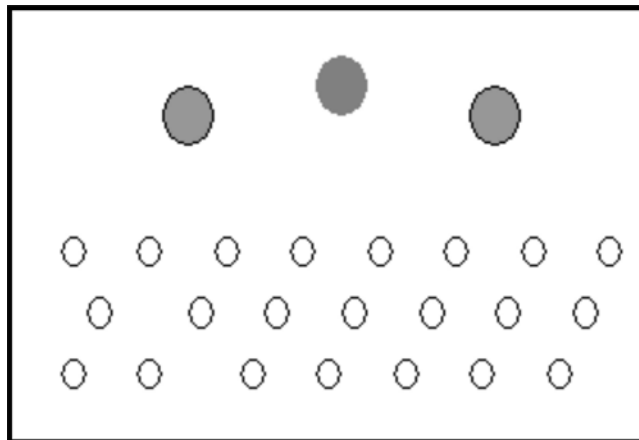

Director Cadets 3, 2006, Ottawa, ON: Department of National Defence

Figure 10-2-2 Instructor at the Front With Two Assistant Instructors

2. Demonstrate before having the cadets attempt each stretch/light cardiovascular exercise.
3. Assistant instructors may help demonstrate the exercises and ensure the cadets are performing them correctly.
4. Have cadets perform each stretch/light cardiovascular exercise.



Light cardiovascular exercises should be done to warm up the muscles prior to stretching to avoid injury to or tearing of the muscles. For example, running on the spot for 30 seconds or performing jumping jacks should be performed prior to conducting the stretches located at Annex A.

SAFETY

- Ensure there are at least two arm lengths between the cadets so they can move freely.
- Ensure the cadets perform the stretches and light cardiovascular exercises in a safe manner, following the guidelines for stretching listed in this TP.

CONFIRMATION OF TEACHING POINT 2

The cadets' participation in the warm-up session will serve as the confirmation of this TP.

Teaching Point 3

Conduct a Recreational Summer Biathlon Activity

Time: 140 min

Method: Practical Activity

ACTIVITY

OBJECTIVE

The objective of this activity is to have the cadets participate in a recreational summer biathlon activity.

RESOURCES

Based on 25 cadets per group, the equipment required to conduct the recreational summer biathlon activity shall include, but is not limited to, the following:

- Cadet air rifles (6),
- Shooting mats (10),
- Air rifle pellets (a minimum of 875 pellets),
- Container to hold pellets (5),
- Stopwatches (6),
- BART (5),
- Safety glasses/goggles (10),
- Notice board,
- Biathlon scoresheets located at Annex C,
- Course control sheets located at Annex D, and
- Range recording sheets located at Annex E.

ACTIVITY LAYOUT

- Set up a first aid station.
- Set up a running route of approximately 1000 m.
- Set up an air rifle range IAW A-CR-CCP-177/PT-001, Part 1, Section 8, with a minimum of five lanes for 25 cadets.
- Set up BARTs.
- Place two shooting mats per firing lane (a minimum of five firing lanes for 25 cadets).
- Place a cadet air rifle at each firing point.
- Place a pair of safety glasses/goggles at each firing point.

ACTIVITY INSTRUCTIONS

Activity instructions are located at Annex B.

SAFETY

- Ensure all range safety procedures are followed.
- Ensure cadets drink fluids and apply sunscreen.
- Ensure the running route is clearly marked and crossing points are monitored anywhere a road may be crossed.
- Ensure a first-aider is identified at the start of the activity and is available at all times.
- Ensure water is available for the cadets during and after the activity.

CONFIRMATION OF TEACHING POINT 3

The cadets' participation in the activity will serve as the confirmation of this TP.

Teaching Point 4

Conduct a Cool-Down Session Composed of Light Cardiovascular Exercises

Time: 10 min

Method: Practical Activity



The following information will be explained to the cadets during the cool-down session.

PURPOSE OF A COOL-DOWN

A cool-down is composed of stretches and light cardiovascular exercises designed to:

- allow the body time to slowly recover from physical activity and to help prevent injury;
- prepare the respiratory system to return to its normal state; and
- stretch the muscles to help relax and restore them to their resting length.



The stretches chosen should focus on the areas of the body that were used the most during the sports activity.

ACTIVITY

OBJECTIVE

The objective of the cool-down is to stretch the muscles and perform light cardiovascular exercises that allow the body time to recover from physical activity, and to prevent injury.

RESOURCES

N/A.

ACTIVITY LAYOUT

N/A.

ACTIVITY INSTRUCTIONS

1. Arrange the cadets in either a warm-up circle or in rows (as illustrated in Figures 10-2-1 and 10-2-2).
2. Demonstrate before having the cadets attempt each stretch/light cardiovascular exercise.
3. Assistant instructors may help demonstrate the movements and ensure the cadets are performing them correctly.
4. Have cadets perform each stretch/light cardiovascular exercise.

SAFETY

- Ensure there are at least two arm lengths between the cadets so they can move freely.
- Ensure the cadets perform the stretches and light cardiovascular exercises in a safe manner, following the guidelines for stretching listed in TP 1.

CONFIRMATION OF TEACHING POINT 4

The cadets' participation in the cool-down session will serve as the confirmation of this TP.

END OF LESSON CONFIRMATION

The cadets' participation in a recreational summer biathlon activity will serve as the confirmation of this lesson.

CONCLUSION

HOMEWORK/READING/PRACTICE

N/A.

METHOD OF EVALUATION

N/A.

CLOSING STATEMENT

Recreational summer biathlon is an activity that requires personal discipline, develops marksmanship skills and promotes physical fitness. Participation in a recreational summer biathlon activity may improve personal fitness level.

INSTRUCTOR NOTES/REMARKS

EO C311.01 (Practice Aiming and Firing the Cadet Air Rifle Following Physical Activity, Section 1) shall be taught prior to conducting this activity.

REFERENCES



- A0-027 A-CR-CCP-177/PT-001 Director Cadets 3. (2001). *Cadet Marksmanship Program: Reference Manual*. Ottawa, ON: Department of National Defence.
- A0-036 Cadets Canada. (n.d.). *Canadian Cadet Movement: Biathlon Championship Series*. Ottawa, ON: Department of National Defence.
- A0-098 Director Cadets 4. (2007). CATO 14-42, *Biathlon Common Program*. Ottawa, ON: Department of National Defence.
- C0-002 (ISBN 0-88962-630-8) LeBlanc, J., & Dickson, L. (1997). *Straight Talk About Children and Sport: Advice for Parents, Coaches, and Teachers*. Oakville, ON: Mosaic Press.
- C0-089 (ISBN 0-936070-22-6) Anderson, B. (2000). *Stretching: 20th Anniversary* (Rev. ed.). Bolinas, CA: Shelter Publications, Inc.

SAMPLE STRETCHES

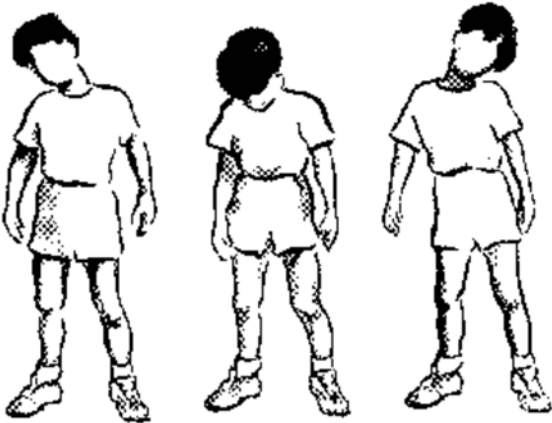
a. Neck:

 <p><i>B. Hanson, Moving on the Spot: A Collection of 5 Minute Stretch and Movement Sessions, Toronto Public Health. Retrieved October 26, 2006, from http://www.lin.ca/resource/html/dn3.htm#1</i></p> <p>Figure 10A-1 Neck Stretch</p>	<p>Slowly roll your head across your chest from shoulder to shoulder. Do not roll your head backwards.</p>
---	--

b. Shoulders:

 <p><i>B. Hanson, Moving on the Spot: A Collection of 5 Minute Stretch and Movement Sessions, Toronto Public Health. Retrieved October 26, 2006, from http://www.lin.ca/resource/html/dn3.htm#1</i></p> <p>Figure 10A-2 Shoulder Push</p>	<p>Stand and extend your arms behind you, interlocking your fingers. Push up and back with your shoulders. Hold this position for a minimum of 10 seconds.</p>
 <p><i>B. Hanson, Moving on the Spot: A Collection of 5 Minute Stretch and Movement Sessions, Toronto Public Health. Retrieved October 26, 2006, from http://www.lin.ca/resource/html/dn3.htm#1</i></p> <p>Figure 10A-3 Shoulder Shrug</p>	<p>Stand and raise your shoulders as high as possible and then lower your shoulders, stretching your neck up. Pull your shoulders back as far as possible and then round your shoulders forward by pushing your shoulders forward as far as possible. Hold each position for a minimum of 10 seconds.</p>



Warm Ups, by Martha Jefferson Hospital, Copyright 2001 by Martha Jefferson Hospital. Retrieved October 26, 2006, from <http://www.marthajefferson.org/warmup.php>

Figure 10A-4 Arm Circles

Hold your arms straight out, palms up. Make small circles with your arms, gradually increasing the size. Reverse the direction of your circles.



Smart Start: A Flexible Way to Get Fit. Retrieved October 26, 2006, from <http://www.in-motion.ca/walkingworkout/plan/flexibility/>

Figure 10A-5 Shoulder Stretch

Either standing or sitting, take your right arm in your left hand and bring it across your chest, supporting the joint by holding it behind the elbow. Pull lightly on the elbow towards your chest. You should feel the stretch in your right shoulder.

Hold this position for a minimum of 10 seconds and repeat on the opposite side.

c. Arms:



Exercises. Copyright 1998 by Impacto Protective Products Inc. Retrieved October 26, 2006, from <http://www.2protect.com/home.htm>

Figure 10A-6 Wrist Rotations

Rotate your hands in circular motions at the wrist. Change direction and repeat on both sides.



Smart Start: A Flexible Way to Get Fit. Retrieved October 26, 2006, from <http://www.in-motion.ca/walkingworkout/plan/flexibility/>

Figure 10A-7 Triceps Stretch

Stand and bring your right arm over your head, bent at the elbow. Use your left hand to gently pull your arm down.

Hold this position for a minimum of 10 seconds and repeat on the opposite side.



Exercise Programme for Squash, Tennis, Softball, Handball. Retrieved October 26, 2006, from <http://www.physionline.co.za/conditions/article.asp?id=49>

Figure 10A-8 Forearm Stretch

In a kneeling position, place your hands on the floor in front of you turned so that your fingers are pointing toward your knees, and your thumbs are pointing out. Keeping your hands flat on the floor, lean back.

Hold this position for a minimum of 10 seconds.

d. Chest and Abdominals:



Smart Start: A Flexible Way to Get Fit. Retrieved October 26, 2006, from <http://www.in-motion.ca/walkingworkout/plan/flexibility/>

Figure 10A-9 Chest Stretch

Stand facing a wall. With your right arm bent and your elbow at shoulder height, place your palm against the wall. Turn your body away from your right arm. You should feel the stretch on the front side of your armpit and across the front of your chest.

Hold this position for a minimum of 10 seconds and repeat on the opposite side.



B. Hanson, Moving on the Spot: A Collection of 5 Minute Stretch and Movement Sessions, Toronto Public Health. Retrieved October 26, 2006, from <http://www.lin.ca/resource/html/dn3.htm#1>

Figure 10A-10 Side Stretch

Stand with your left arm up over your head. Bend at your waist towards the right side of your body.

Hold this position for a minimum of 10 seconds and repeat on the opposite side.

e. Back:



Smart Start: A Flexible Way to Get Fit. Retrieved October 26, 2006, from <http://www.in-motion.ca/walkingworkout/plan/flexibility/>

Figure 10A-11 Lower Back Stretch

Lie on your back and bring your knees toward your chest. Grasp the back of your knees. Hold this position for a minimum of 10 seconds.



Smart Start: A Flexible Way to Get Fit. Retrieved October 26, 2006, from <http://www.in-motion.ca/walkingworkout/plan/flexibility/>

Figure 10A-12 Upper Back Stretch

Extend your arms straight in front of you at shoulder height crossing one arm over the other. With the palms facing each other, intertwine your fingers and press out through your arms. Let your chin fall to your chest as you exhale. You should feel the stretch in the upper back.

Hold this position for a minimum of 10 seconds and repeat on the opposite side.

f. Legs:



Smart Start: A Flexible Way to Get Fit. Retrieved October 26, 2006, from <http://www.in-motion.ca/walkingworkout/plan/flexibility/>

Figure 10A-13 Hamstring Stretch

Lie flat on the floor with your knees bent and your back flat on the floor. Slowly raise and straighten one leg, grasping it behind your thigh with both hands. Hold this position for a minimum of 10 seconds.



Smart Start: A Flexible Way to Get Fit. Retrieved October 26, 2006, from <http://www.in-motion.ca/walkingworkout/plan/flexibility/>

Figure 10A-14 Inner Thigh Stretch

Sit on the floor with your knees bent and the soles of your feet together. Grab your toes and pull yourself forward while keeping your back and neck straight.

Hold this position for a minimum of 10 seconds.

Grab your ankles and push your knees down toward the floor with your elbows.

Hold this position for a minimum of 10 seconds.



Smart Start: A Flexible Way to Get Fit. Retrieved October 26, 2006, from <http://www.in-motion.ca/walkingworkout/plan/flexibility/>

Figure 10A-15 Hip Flexor

Kneel on your right knee. Position your left foot in front of you, bending your knee and placing your left hand on that leg for stability.

Keep your back straight and abdominal muscles tight. Lean forward, shifting more body weight onto your front leg. You should feel the stretch in the front of your hip and the thigh of the leg you are kneeling on. Cushion your kneecap with a folded towel if necessary.

Hold this position for a minimum of 10 seconds and repeat on the opposite side.



Running Exercises. Retrieved October 26, 2006, <http://www.physionline.co.za/conditions/article.asp?id=46>

Figure 10A-16 Ankle Rotations

From a sitting position, rotate your foot in a clockwise, and then a counter-clockwise, direction.

Switch and repeat on the opposite side.



Smart Start: A Flexible Way to Get Fit. Retrieved October 26, 2006, from <http://www.in-motion.ca/walkingworkout/plan/flexibility/>

Figure 10A-17 Calf Stretch

Stand three steps away from and facing a wall. Step in towards the wall with your right leg, bending your right knee and keeping your left leg straight. Extending your arms with your palms forward, reach out to the wall and let your body fall toward the wall. Keep your toes forward and your heels down. Lean your body into the wall with your left leg straight behind your body. You should feel the stretch in your left calf.

Hold this position for a minimum of 10 seconds and repeat on the opposite side.



Smart Start: A Flexible Way to Get Fit. Retrieved October 26, 2006, from <http://www.in-motion.ca/walkingworkout/plan/flexibility/>

Figure 10A-18 Quadriceps Stretch

Stand with your hand against a wall for balance. Lift your left foot off the ground, bending your knee as if you are trying to kick your bottom with your heel. Do not lean forward at the hips. Grab and hold your ankle with your left hand. You should feel the stretch in your left thigh.

Hold this position for a minimum of 10 seconds and repeat on the opposite side.

GUIDELINES TO CONDUCT A RECREATIONAL SUMMER BIATHLON ACTIVITY

OBJECTIVES

The objectives of the recreational summer biathlon activity are:

- to practice and improve marksmanship skills;
- to improve personal fitness level; and
- to introduce the cadets to the sport of summer biathlon.

COMPOSITION

Cadets will be divided into teams for the summer biathlon activity. For a group of 25 cadets, the cadets should be divided into groups of five.

FACILITIES

The facilities required to conduct a recreational summer biathlon activity are:

- a route, approximately 1000 m with the start and finish lines located close to the range. The route should be wide enough to accommodate a maximum of 10 cadets running at one time. When roads are to be crossed, they must be clearly marked and a central crossing point established with traffic control provided, and

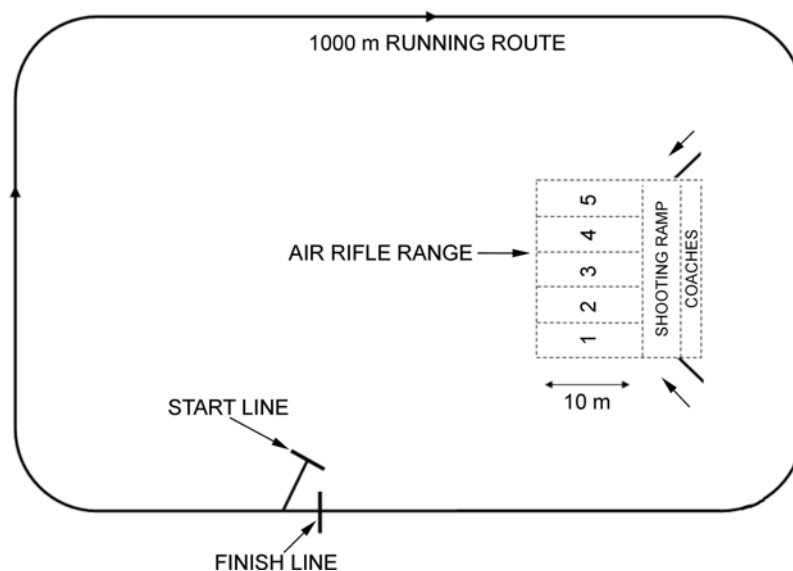

Director Cadets 3, 2008, Ottawa, ON: Department of National Defence

Figure 10B-1 Recreational Summer Biathlon Activity Course Layout

- an air rifle range constructed IAW A-CR-CCP-177/PT-001, Part 1, Section 8, with a minimum of one firing lane per cadet per group.

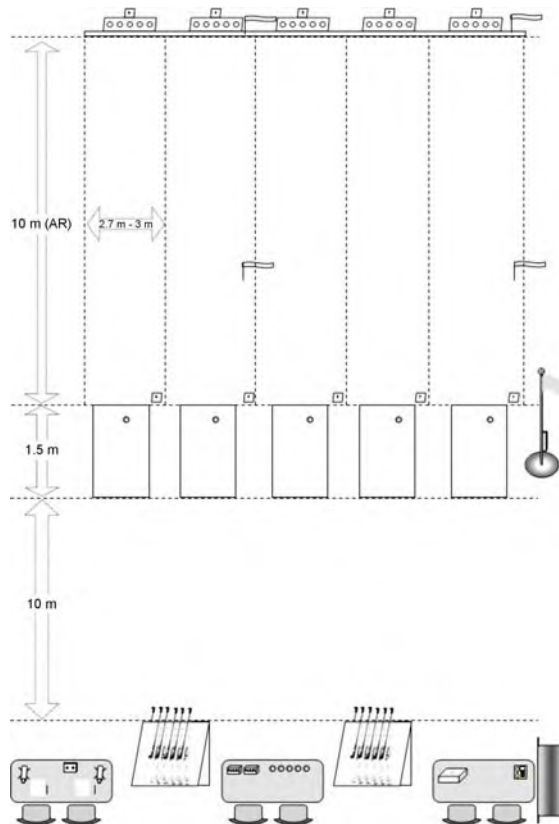

Director Cadets 3, 2008, Ottawa, ON: Department of National Defence

Figure 10B-2 Recreational Summer Biathlon Air Rifle Range Layout

STAFFING

Numerous staff are required to conduct a recreational summer biathlon activity. These appointments shall include:

- **Technical Delegate.** Responsible for the overall conduct of the competition, including issuing penalties, and interpreting the rules.
- **Range Safety Officer (RSO).** Responsible for the overall conduct of the activities on the range.
- **Assistant RSO.** Responsible for targets, issuing ammunition, and assisting the RSO, as required.
- **Lane Scorekeeper.** Responsible for scoring targets and recording results on the range recording sheet (located at Annex E).
- **Chief of Statistics.** Responsible for compiling all the event data (eg, range results, start/finish time, and any penalties assessed).
- **Runner.** Responsible for collecting the scoring sheets and delivering them to the chief of statistics.
- **Start and Finish Line Chief.** Responsible for starting the run and recording the finish times on the scoresheet (located at Annex C).
- **Course Controller.** Responsible for recording each time the cadet runs a route on the course control sheet (located at Annex D).
- **First-Aider.** Responsible for dealing with any injuries that may occur during the competition.

FORMAT

Briefing

All cadets will attend an initial briefing. This will include the essential information required by the cadets to participate in the recreational summer biathlon activity. The cadets are given:

- start times,
- range lane assignments,
- weather updates, and
- an introduction to the competition staff.

The Running Route

Each cadet will run three separate routes of approximately 1000 m. Each running route will consist of:

- each team assembling for a mass start (teams will have a two-minute interval between start times);
- each team finishing as a complete team; and
- crossing the finish line as a team.

The Range

Each cadet will fire five to eight pellets in an effort to knock down all five targets on the BART. After each bout of firing, the appropriate lane scorer will record the team's results and reset the BART.

When all members of the team have completed firing, they will re-assemble for a mass start for the next running route.

SEQUENCE

This recreational summer biathlon activity will be conducted in the following sequence:

- running a route of approximately 1000 m;
- firing five to eight pellets at the BART;
- running a route of approximately 1000 m;
- firing five to eight pellets at the BART;
- running a third route of approximately 1000 m; and
- crossing the finish line.

EQUIPMENT

Based on 25 cadets, the equipment required to conduct the recreational summer biathlon activity shall include, but is not limited to, the following:

- Cadet air rifles (6),
- Shooting mats (10),
- Air rifle pellets (a minimum of 875 pellets),
- Container to hold pellets (5),

- Stopwatches (6),
- BART (5),
- Safety glasses/goggles (10),
- Notice board,
- Biathlon scoresheets located at Annex C,
- Course control sheets located at Annex D, and
- Range recording sheets located at Annex E.

DRESS

Appropriate clothing according to the weather forecast.

RULES AND REGULATIONS

- The cadets must remain in their own teams throughout the activity
- The cadets must use the same firing lane for the duration of the activity.
- The run must be completed in the proper sequence and on the marked route.
- Cadet air rifles must be placed on the firing point by the range staff and will remain there for the duration of the activity.
- All firing will be done in the prone position.
- The cadet air rifle must be made safe upon completion of firing.
- An inoperable cadet air rifle will be replaced by the range staff, the target will be reset, and the cadet will fire five to eight rounds with the new rifle.
- Safety infractions will result in time penalties.
- Missed targets will result in time penalties.

SCORING

The team's final score is determined by adding the total time for all run routes plus any penalties issued. The team with the lowest final score is considered the winning team.

Scoring will be calculated as follows:

- **Time.** The team's final time is the time from the start to finish, and any penalties.
- **Targets.** For each relay of firing, the number of hit and missed targets will be recorded on the range recording sheet by the lane scorekeeper (located at Annex C). There is no positive point value for each hit target; competitors will be deducted points for each missed target.

PENALTIES

The following penalties will be added to the team's time:

- Each violation of the principles of fair play or good sportsmanship will result in a one-minute penalty, to include:
 - not giving way in an area of congestion;

- pushing or shoving;
- using profanity; and
- interfering with other competitors.
- Each missed target will result in a 10-second penalty.
- Each safety infraction on the firing point will result in a two-minute penalty, to include:
 - not keeping control of the cadet air rifle;
 - moving forward of the firing point; and
 - intentionally firing rounds at objects other than the BART.
- Each team member not crossing the finish line will result in a two-minute penalty.

OUT OF BOUNDS AREA

Out of bounds areas will be clearly identified prior to the start of the recreational summer biathlon activity.

NOTES

- Course control staff will record each time a team completes a route. See course control sheet located at Annex D.
- The start and finish line chief will keep records for each team. When the sheet is full or nearly full the runner will take the sheet to the chief of statistics. See scoresheet located at Annex C.
- Bibs may be used to identify cadets, if available.

THIS PAGE INTENTIONALLY LEFT BLANK

BIATHLON SCORESHEET

Scorekeeper's Name: _____

Cadet Name	Bib #	Start Time	Route One	Route Two	End Time (Route 3)	Run/Safety Penalties	Firing Penalties	Total Time
Note: The start and finish line chief is responsible for recording the run times and presenting the scoresheet(s) to the scorekeeper.								

THIS PAGE INTENTIONALLY LEFT BLANK

THIS PAGE INTENTIONALLY LEFT BLANK

RANGE RECORDING SHEET

Scorekeeper's Name: _____

Cadet Name:	Lane	Shots Fired	X = Miss	Misses	Comments/Penalties
		3 Spare	○ ○ ○ ○ ○		
Cadet Name:	Lane	Shots Fired	X = Miss	Misses	
		3 Spare	○ ○ ○ ○ ○		
Cadet Name:	Lane	Shots Fired	X = Miss	Misses	
		3 Spare	○ ○ ○ ○ ○		
Cadet Name:	Lane	Shots Fired	X = Miss	Misses	
		3 Spare	○ ○ ○ ○ ○		
Cadet Name:	Lane	Shots Fired	X = Miss	Misses	
		3 Spare	○ ○ ○ ○ ○		
Cadet Name:	Lane	Shots Fired	X = Miss	Misses	
		3 Spare	○ ○ ○ ○ ○		
Cadet Name:	Lane	Shots Fired	X = Miss	Misses	
		3 Spare	○ ○ ○ ○ ○		
Cadet Name:	Lane	Shots Fired	X = Miss	Misses	
		3 Spare	○ ○ ○ ○ ○		
Cadet Name:	Lane	Shots Fired	X = Miss	Misses	
		3 Spare	○ ○ ○ ○ ○		

THIS PAGE INTENTIONALLY LEFT BLANK

